



MODEL: GT8907

Digital Anemometer Instruction Manual



Standard: Q/GMY 006-2016
Version: GT8907-EN-00

CONTENTS

1. Before Use Notice

Check up-----	(01)
Introduction and functions-----	(02)
Name of parts-----	(03)
LCD Displays-----	(05)
Specifications-----	(07)

2. Operation manual

Measurement of wind speed, temperature and humidity ----	(09)
Wind volume measurement-----	(10)
Wind volume 2/3V MAX value measurement-----	(12)
Measurement of maximum/average/minimum value -----	(12)
Measurement and calibration of wind direction angle -----	(14)
Data holding -----	(14)
Data storage -----	(15)
Data reading -----	(16)
Data clearing and Automatic shutdown -----	(17)

3. Host and PC connection

Software installation instructions -----	(18)
Software interface instruction -----	(20)

4. Others

Familiar trouble shooting-----	(23)
Maintenance & Warranty-----	(24)

1. Before Use Notice

Check up

Thank you for purchasing our Air Flow Anemometer! Carefully unpack your kit and ensure that you have the following Items .In case that any item is missing or if you find any mismatch or damage ,promptly contact your local dealer .

○ Digital Anemometer	1PCS
○ Auxiliary Fan	1PCS
○ USB Computer connecting cable	1PCS
○ 1.5V AAA alkaline battery	4PCS
○ English Instruction Manual	1PCS
○ PP Packing box	1PCS



Introduction

Digital multifunctional anemometer is a professional instrument for measurement of wind speed, temperature, and humidity. It is designed for wind speed measurement in various environments, such as wind speed measurement engineering, quality control, and health control. It is applied in wind speed measurement for various occasions like factories, schools, offices, transportation routes, families, etc.

Functions

- Measure current wind speed, temperature and humidity.
- Measurement of current air volume, temperature and humidity.
- Measure wind speed/ MAX wind flow/min wind flow.
- 2/3 wind flow value/ average value.
- Wind speed/flow units and temperature units selection.
- Measure wind direction angle.
- Real-time measurement when connecting USB with computer software.
- Backlight and data holding (HOLD).
- Low battery indication.
- Automatic shutdown setting.

Name of parts (Figure 1)

- 1:  button 1: MAX/AVG/MIN
- 2:  button 2: confirm (ENTER), 3/2VMAX wind flow, long press to enter into direction angle calibration.

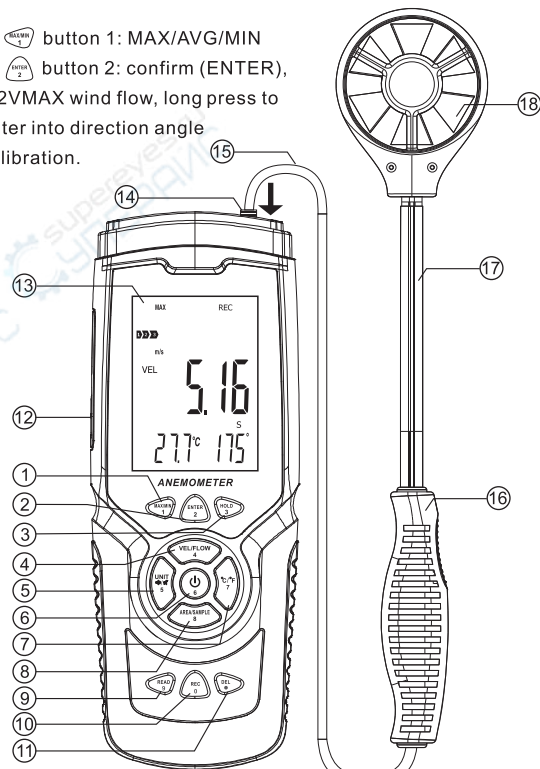











Figure 1

3.  button 3: data holding (HOLD).
4.  button 4: switch between wind velocity and wind flow.
5.  button 5: Short press unit switch (UNIT) and long press to open or close keytone.
6.  button 6: startup, short press to turn on/off backlight, long press to shutdown.
7.  button 7: short press °C/°F to switch temperature unit, long press to switch between temperature and humidity.
8.  button 8: area setting (AREA), record time interval (SAMPLE), read recording number.
9.  button 9: enter into read/save/record interface.
10.  button 0: save one datum or enter into data recording interface (REC).
11.  button •: saving a piece of datum or entering into data recording interface.

12. USB interface.

13. LCD display.

14. Connector (align with joint hole during insertion↓).

15. Connection line.

16. Slip resistant handle.

17. Retractable drag rod.

18. Six wind wheels.

Note: In the setting interface for area, time interval of recording and reading serial number of record, buttons can be used as number button, you can complete the input by long pressing ENTER button to confirm the set value. During input, You can also press "SAMPLE/AREA" button to cancel the current setting operation.



Note:

The above is only a brief introduction to button functions. For detailed function and operation description, please refer to "Operation Instruction" section in this manual.

LCD Displays

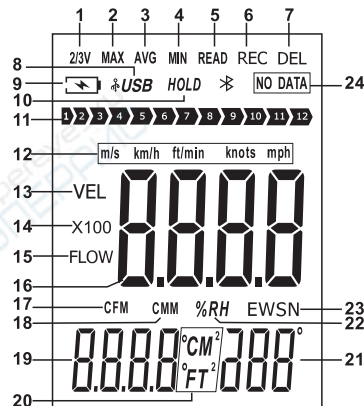

1. 2/3V :2/3 of max wind flow.

2. MAX :Maximum value.

3. AVG :Average wind velocity/ wind flow.

4. MIN :Minimum value.

5. REDA :Read recorded data.

6. REC :Record data.

7. DEL :Delete recorded data.

8.  :USB connection.

9.  :Low battery indicator.

10. HOLD :Data holding.

11. **0.2** : Wind level.
12. Wind velocity unit : m/s, km/h, ft/min, knots, mph.
13. VEL : wind velocity.
14. X100 : wind flow multiplier.
15. FLOW : wind flow measurement.
16. Wind velocity/flow value.
17. CFM : wind flow unit (cubic feet/minute).
18. CMM : wind flow unit (cubic meter/minute).
19. Wind temperature value/ vent area value.
20. $^{\circ}CM^2$: Indicating duct area in square meter in flow function, " $^{\circ}C$ " is used to indicate wind temperature in metric.
 $^{\circ}FT^2$: Indicating duct area in square feet when in flow function ; " $^{\circ}F$ " is used to indicate wind temperature in metric;

21. wind direction angle
22. %RH : humidity unit
23. EWSN : wind direction

E(east wind), W(west wind)

S(south wind), N(north wind)

ES(southeast wind), EN(northeast wind)

WS(southwest wind), WN(northwest wind)

24. NO DATA : no recorded data

Specifications

1. Wind Velocity Range

Unit	Wind Velocity Range	Resolution	Lowest Point of start value	Accuracy
m/s	0.0~45.0	0.01	0.3	$\pm 3\% \pm 0.1$
Ft/min	0.0~8800	0.01/0.1/1	60	$\pm 3\% \pm 20$
Knots	0.0~88.0	0.01	0.6	$\pm 3\% \pm 0.2$
Km/h	0.0~140.0	0.01	1	$\pm 3\% \pm 0.4$
Mph	0.0~100	0.01	0.7	$\pm 3\% \pm 0.2$

2. Wind flow range

CFM: 0-999900 ft³/min

CMM: 0-999900 m³/min

Unit	Range	Resolution	Area
CFM(FT ³ /MIN)	0-999900	0.001-100	0.001-9999ft ²
CMM(M ³ /MIN)	0-999900	0.001-100	0.001-9999m ²

3. Unit Conversion

	m/s	Ft/min	Knots	Km/h	Mph
1m/s	1	196.87	1.944	3.60	2.24
1ft/min	0.00508	1	0.00987	0.01829	0.01138
1knots	0.5144	101.27	1	1.8519	1.1523
1km/h	0.2778	54.69	0.54	1	0.6222
1mph	0.4464	87.89	0.8679	1.6071	1

4. Wind Temperature:

(1) Temperature Range

Unit	Scale	Resolution	Accuracy
$^{\circ}C$	0~45	0.1	$\pm 1.0^{\circ}C$
$^{\circ}F$	32~113	0.18	$\pm 1.8^{\circ}F$

(2) Humidity range

Unit	MIN/MAX	Resolution	Accuracy	Test Conditions
%RH	10~90	0.1	±5%	90% RH (non-condensing)

5. Operating Current:

Unit	Description	Min/Max	TYP	Test Conditions
mA	Operating Current1	15~20	18	The backlight is off
mA	Operating Current2	20~25	23	Backlight is on
V	Low battery indicating	3.5~4.5	4	
uA	Stand by current	0~8	5	

6. Operation Conditions

Temperature	0~50°C (32~122°F)
Humidity	40~80%RH

7. Storage Conditions

Temperature	-40~60°C (-40~140°F)
Humidity	≤80%RH

8. Power supply : AAA 1.5V Alkaline battery *4

9. Dimensions:

Meter :73x38x194mm

Vane: 74x35x2100mm (After lengthening)

10. Product Weight:

Host: 212.9g (without battery)

Attached machine: 180g

2. Operation manual

Measurement of wind speed, temperature and humidity

- Before measurement: make sure to insert the connector plug of fan auxiliary unit with ↓ mark downwards into host socket. If the direction is wrong, the plug may be damaged.
- Press ON button to turn on the instrument. After 1s of LCD full screen, wind speed and wind temperature are displayed, and VEL shows up on the screen.

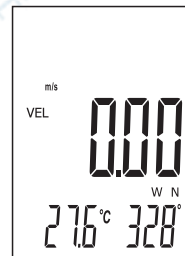

- Press the " UNIT " key, the wind flow unit changes among m/s , km/h , ft/min, knots, mph,(default unit is m/s);
- Press the " °C/°F " , the temperature changes between °C/°F mode(defaulted as °C).
- Long press °C/°F button to switch to display of humidity.

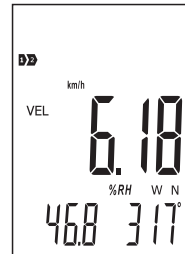

- Hold the Anemometer with your hand , place the vane in the air flow with the air direction matching the direction of the arrows printed on the inner walls of the vane (please do not extrude the fan leaf, which may cause the inaccuracy measurement)

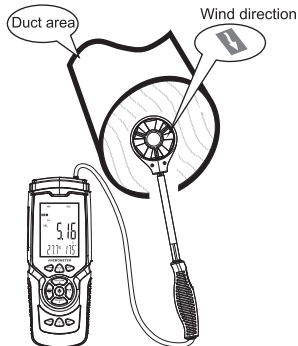

- 1). Wait for 2 seconds with the unit is ready for use.
- 2). Place the vane in the same direction of the wind to capture the accurate data ,temperature within 20°C
- 3). The dynamic indicator bar of wind speed will increase gradually as wind speed increases.

Wind volume measurement

- Press VEL/FLOW button to switch to FLOW mode and display wind volume.
- Press UNIT button to switch wind volume unit, and area unit will also change with wind volume unit as CMM---M², CFM---FT².
- Press AREA button to enter into area setting interface. ___ is displayed at the bottom left of the screen, and the spot for input flashes. At this time, the area of the tuyere can be input. You can complete the input by pressing ENTER button; for example, input 1.2, then long press ENTER button and the area value is set as 1.2. In the process of inputting area value, long press ARER button to cancel the current area setting.

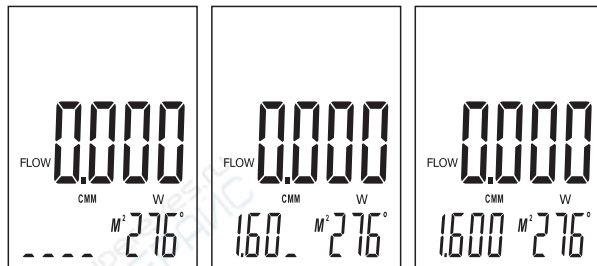

- Place the vane in the duct area to measure current wind flow value right away.As shown in following figure:

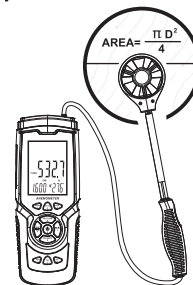

- Wind Flow Calculate Formula : Flow =velocity *(Free Area)
- Testing Wind velocity : The bar icon (showing on the middle of LCD)changes accordingly with wind Flow/Velocity.



Note:

- a. failing to enter the duct area leads to failure of measurement of the wind flow.
- b. If wind flow is larger than 9999, the LCD screen will show x10 or x100, indicating the measured value multiplied by x10 or x100.

Wind volume 2/3V MAX value measurement

- In wind volume measurement interface, short press ENTER button to display 2/3 times of maximum wind volume value. At the same time, the screen will display 2/3VMAX icon, short press ENTER to exit.

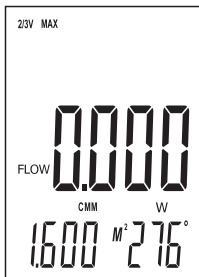

- Calculation formula of 2/3MAX wind volume: $FLOW = 2/3 * MAX \text{ wind speed} * \text{tuyere area}$.

Measurement of maximum/average/minimum value

- When measuring wind speed and volume, press the MAX/AVG/MIN button to measure the maximum, average and minimum values of wind speed and volume. At the same time, the screen will display MAX, AVG and MIN.
- MAX: The displayed wind speed or volume value is the maximum value measured since the wind speed or volume value is set as MAX.

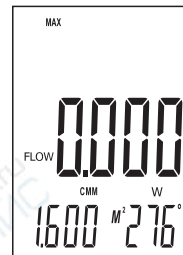

- AVG: The displayed wind speed or volume value is the average value in the last 10s.

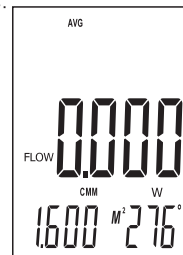

- MIN: The displayed wind speed or volume value is the minimum value measured since the wind speed or volume value is set as MIN.

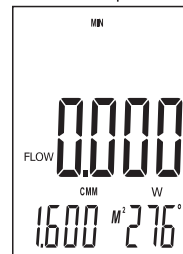

Measurement and calibration of wind direction angle

- A three-axis magnetic field sensor is installed under wind blade of the instrument to measure wind direction angle. When measuring wind direction, keep the handle vertical, and direct wind blade at the measured wind according to the wind direction arrow, and the corresponding wind direction and angle will be displayed at the bottom right of the screen. Wind directions are as follows: E—East wind, W--West Wind, S--South Wind, N--North Wind, ES--Southeast Wind, EN--Northeast Wind, WS--Southwest Wind, WN--Northwest Wind.
- Due to different magnetic field distribution in different regions, wind direction angle value can be self-calibrated when you feel reading error is big. Long press ENTER button to enter calibration interface of wind direction and "EWSN" and "--" flashes at the lower right side. Then make the handle vertical, slowly rotating the handle for two rounds (about 8 seconds per round), then press ENTER button to save and complete calibration.

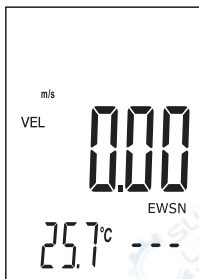

Data holding

- During measurement of wind speed and volume, press "HOLD" button to lock the data, and then press "HOLD" button to release.

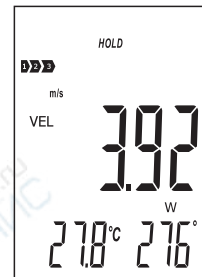

Data storage (TB: 960 data)

- Record single datum:
 - Under "VEL" state, press the "SAMPLE" button, input "0", and press "ENTER" button to confirm.
 - Each time you press "REC" button, the data can be stored at a time. If data is full, the screen will display "FULL".

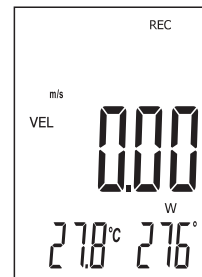

- Continuously record data:
 - Under "VEL" state, press "SAMPLE" button, input recording interval (0~9999 seconds), and long press "ENTER" button to confirm.

- b. Press "REC" button to enter into recording interface and start recording a sum of data continuously at the set recording interval. At this time, each time "ENTER" button is pressed, the recording interval and measured data will be displayed at the lower left of the screen; if the data is full, the screen will display "FULL" and then return to the normal measurement interface.
- c. Long press "REC" button to exit recording interface and stop recording; "REC" is no longer displayed.

Data reading

- Under normal measurement interface, press "READ" button to enter reading interface of recorded data. The bottom left side will display the serial number of recorded data first and then measured data. Every time you press "ENTER" button, the bottom left of the screen will display the serial number first and then the recorded value.
- Press "READ" button to view the record data of next serial number.
- Press "SAMPLE" button to input the serial number of recorded data to be viewed. After finishing input, long press "ENTER" to confirm, when the input serial number is bigger than the serial number of stored record, the recorded data with the largest serial number will be displayed.
- Long press "READ" button to exit data reading interface. The icon "READ" will no longer be displayed.



Data clearing

- After pressing "DEL" button for 2s, "DEL" will be displayed on the upper right corner of the screen. When "CLR" is displayed on the center of the screen, the data of the instrument will be cleared.



Automatic shutdown

- The instrument has automatic shutdown function, which will automatically shut down after 5 minutes of no button operation.
- No automatic shutdown can also be set. Long press "Enter" button to start, the screen displays "no", and the instrument will not automatically shut down, so you need to manually turn it down. No automatic shutdown is only for the current time, and the instrument will return to automatic shutdown in the next time.

3. Host and PC connection

Software installation instructions

*This product software is installed in English by default. After installation, you can switch among: English, Simplified Chinese, Traditional Chinese.

1).Computer configuration requirements:

- CPU: Pentium III 600MHz or above.
- A freely available USB connector.
- The screen resolution of screen should be at least 800*600 (or higher) with true color;
- At least 8MB of available memory space.
- At least 50MB of free disk space.
- Operating system: XP, Win7, Win10.

2).Install data acquisition software: enter the website

www.benetechco.net in the browser, press enter and enter the page to find the menu "Support > Download center",as shown in Figure 2. Click into the page to find the software installation package "setup_Anemometer. Zip",as shown in figure 3.Click the download button to directly extract the "zip package" after downloading. Double-click "setup_Anemometer.exe" icon to enter into program installation interface; choose between"Chinese or English" according to software installation prompt; click "OK" to the next step, as shown in Figure 4 below.

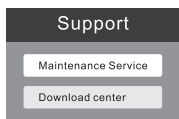

Figure 2

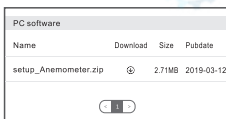

Figure 3

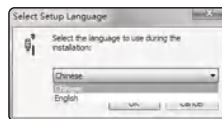

Figure 4

3).Just follow installation prompt: click after prompt "Next" for 2 consecutive until "Create a desktop shortcut" and "Create a Quick Launch shortcut" appear on the screen. Tick and click "Next", choose "Install" in the next prompt (do not click "Cancel"); wait for the progress bar to complete; click "Finish" directly to complete the installation, as shown in Figure 5 below.



Figure 5

Remarks:

Launch shortcut on user's desktop: right click "Anemometer" in Start\Programs\Anemometer, and send shortcut icon to desktop.

If you want to delete the software, you can also select "Anemometer" in Start\Programs>Select, then select "Delete" icon.

Software interface instruction

- Language switch step: Click real-time measurement icon "Real Time Measure" to enter into measurement interface, select "Option" in menu bar, click the right triangle in "Language" to select language. As shown in Figure 6 below
- Toolbar: as shown in Figure 6 below (1) File, (2) Option, (3) Help.

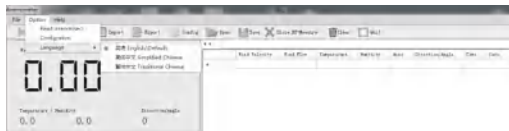

Figure 6

- Start page: as shown in Figure 7 below
 - (1) Real-time measurement "Real Time Measure": Enter real-time measurement interface.
 - (2) Read storage of instrument "Device Storage": Read history record of instrument.
 - (3) Erase storage of instrument "Erase Storage".



Figure 7

Note: As for Files, option, help, you can see details of corresponding multiple attributes by pointing cursor on the item.

- Button bar: as shown in Figure 6 below
 - (1) Start measurement
 - (2) Pause
 - (3) Import
 - (4) Export
 - (5) Configuration
 - (6) Open
 - (7) Save
 - (8) Off - Real-time measurement
 - (9) Empty
 - (10) Exit

- Display area: switch wind speed and volume according to the instrument, the corresponding curve will be displayed in display area (line chart); as shown in Figure 8 below.

- Line chart: Figure 1 is wind speed / volume chart; Figure 2 is temperature and humidity chart; print button; measured data list.

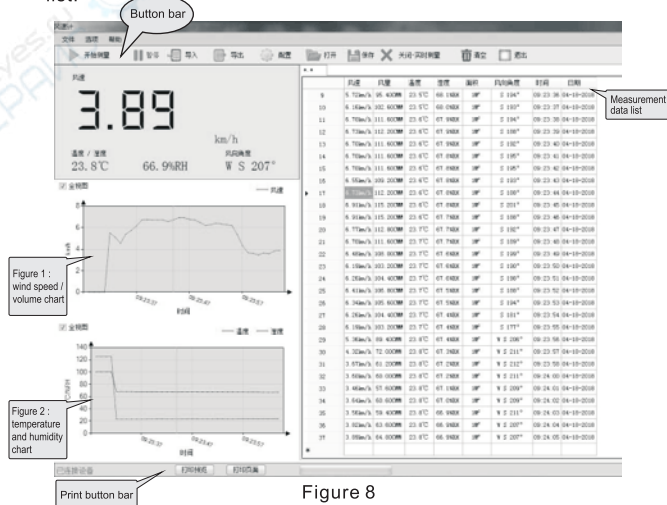

Figure 8

- List: Record the data passed by the meter, you can import and export data (can have Two formats. save form in ane/.xls).
- Status bar: The status of operation process will be presented in the lowermost column.
- Print button: The current page can be printed out.

Remarks:

- 1.Real-time measurement operation cannot be performed after entering reading instrument storage interface, so you must press the "real-time measurement since file start page".
- 2.The lower left corner will inform the current connection status of the instrument.
- 3.The content in pop-up window of button bar will be displayed in the first line of the exported Excel.
- 4.After successful installation, the default language is English, which can be changed by the user.
- 5.Click on line chart to display the current X, Y axis labels, drag for enlarged image, double click to return to the pre-state.
- 6.Click on any cell in the list to display X and Y axis labels on the line graph.

4. Others

Familiar trouble shooting

- The following is a list of actions to be taken if the unit is not working properly:
- Screen is blank : Check the battery is inserted correctly. Open the battery door on the bottom rear of the unit. The "+" "-" symbols on the battery should match the corresponding "+" "-" symbols on the inside of the battery compartment.
- If the unit can not connect to PC normally, please check the USB cable is OK, if the cable can not be used formally, please replace for a new one.
- If the unit can not read the wind flow value properly, please check if the vane is block or not.
- When the instrument cannot read the temperature or humidity data correctly, please check if the connection wire between blade handle and the instrument is loose.
- If the unit can not read data properly, please check if it is operated under the rule temperature and humidity situation.



Note:

When not connecting to PC, the unit will power off automatically after 5 minutes if no any operation after power on.

Maintenance & Warranty

1. Maintenance:

- Replacing the battery and product maintenance:
 - a. Remove the battery from the unit if it is not required for extended periods of time in order to avoid damage to the battery compartment and the electrode resulting from a leaking battery.
 - b. After power on, if a symbol “” appears on the LCD, indicating that you should replace the battery in order to avoid inaccurate measuring reading.
Otherwise the battery is very possible leak that will seriously damage the unit life.
The battery compartment is on the down rear of the unit, open the battery door, replace the old battery for new battery (notice the battery polarity), close the battery door.
- Cleaning the casing :
Never use alcohol or thinner to clean the unit casing, which will especially erode the LCD surface; just clean the unit lightly as needed with little clean water.
Never impact the unit or use on humidity condition.
Do not store or use the unit in following locations where the unit may be subject to:
 - a. Splashes of water or high levels of dust.
 - b. Air with high salt or sulphur content.
 - c. Air with other gases or chemical materials.
 - d. High temperature or humidity or direct sunlight.

2. Warranty:

About relative warranties please read provided warranty card. We disclaim any liability due to: transportation damages; incorrect use or operation; manipulation, alterations or repair attempts; without warranty card, invoice.



Special Statement:

- a. Disposal of battery should be handled in accordance with local laws and regulations.
- b. Our company shall hold no any responsibility resulting from using output from this product as an direct or indirect evidence.
- c. This company reserves the right of changing the product design and contents of instruction if changed the separate notice isn't given.