

背光控制电路 (可IO或者PWM控制)

TFT_BL 高电平使能

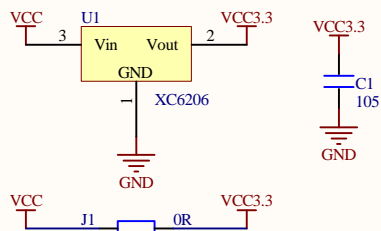

供电电源选择：

外部VCC输入5V时，J1断开
外部VCC输入3.3V时，J1短接

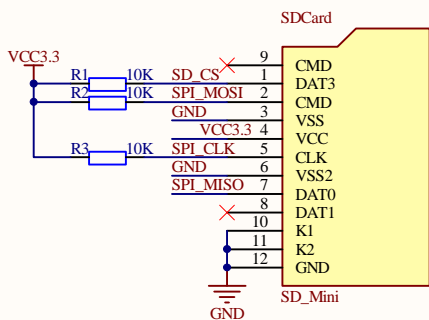

SD卡接口电路

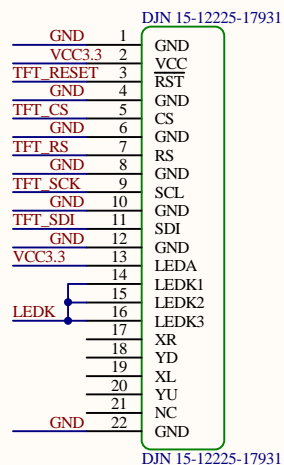

液晶屏22Pin接口

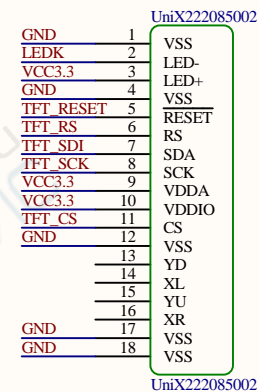

液晶屏18Pin接口

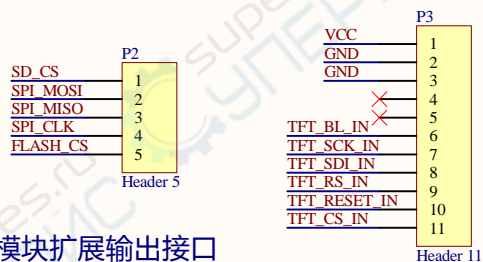

模块扩展输出接口

扩展输出排针默认不焊接

液晶屏模块接口

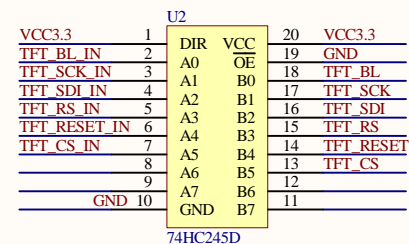

74HC245电平转换电路

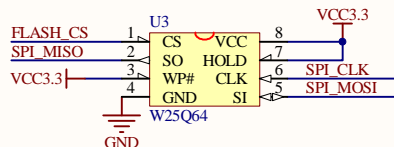

SPI_FLASH接口电路(不焊接)

深圳市全动电子技术有限公司

ShenZhen QDtech Co.,LTD

因为专注，所以专业

Title		
Size	Number	Revision
A4		
Date:	2014/1/6	Sheet of
File:	D:\学习\TFT_TM022HDH26.SchDoc	Drawn By: