

**DAJA<sup>®</sup>**

DJ6 Laser Engraving Machine User Manual

Please read this manual carefully before use  
and keep it properly for future reference.

**Thank you for choosing our laser engraving machine, which is a high-tech optical-electric mechanical equipment. Please read the user manual carefully and follow the instructions for better use and maintenance of the equipment.**

## **Important Statement!**

All losses resulting from improper use or failure to follow the manual instructions shall be borne by the user itself. Our company owns the final interpretation right of the user manual as well as the right to modify all the items, data and technical details in this user manual.

## **Safety Precautions**

- ★The operator must read the user manual carefully before use and strictly abide by the operation instructions.
- ★Risks may exist in laser processing and the user should carefully consider whether the object is suitable for laser processing.
- ★The object to be processed and corresponding emissions shall comply with the requirements of local laws and regulations.
- \*This machine adopts four types of laser equipment (strong laser radiation), which may cause the consequences as follows:
  - ①Ignite the ambient combustibles;
  - ②Other radiation or toxic and harmful gases may be produced during the laser processing of different objects;
  - ③Direct exposure in laser radiation can cause physical injury. Fire-fighting equipment must be available on the site. It's prohibited to stack flammable and explosive materials on the workbench and around the equipment. At the same time, the site must have good ventilation.
- \*The place to use the machine should be dry, free from interference and influences by pollution, vibration, strong electricity and magnetism. Ambient temperature should be 10-35°C and humidity should be 5-95% (no condensing water)
- ★Working voltage: AC100-240V.
- \*The engraving machine and other related equipment must be safely grounded before it switched on for operation.
- ★The machine must be fully monitored during the whole operation process. All power must be cut off before personnel departure to prevent abnormal consequences. In case of any accidents, please cut off the power immediately!
- \*It's prohibited to place any irrelevant objects with total reflection or diffuse reflection in the machine to prevent the laser from being reflected to human body or flammables.
- \*Keep the machine away from electrical equipment which is sensitive to electromagnetic interference, otherwise the electromagnetic interference may occur.
- \*Laser machine has high voltage or other potential dangers, it's prohibited to be disassembled by non-professionals.

## Pay attention!



1. When the laser is turned on, it's prohibited to aim at humans, animals and flammables to avoid skin burns and fire.



2. The laser brightness is harmful to the eyes. Do not look directly at the laser.



3. Keep hands away from the machine during operation to avoid injury.



4. Turn off the machine when it is not in use to avoid misoperation by third parties.

## Maintenance

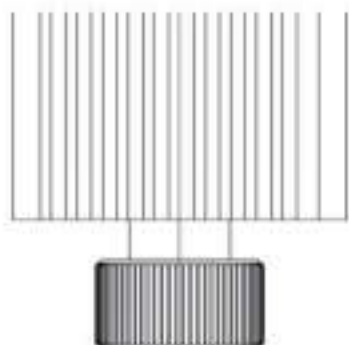

Laser head is consumable. It's recommended to keep the machine power off for 10 minutes after 4-hour engraving and keep the machine power off for 10 minutes after 1-hour cutting.

Brand	DAJA
Model	DJ6
Material	ABS + Aluminum alloy
Control Method	PWM
Operation Systems	Win7/Win8/Win10/MAC/iOS/Android
Applicable Materials	Paper/Wood chip/Plastic/Stone/Leather/Fabric/Bamboo/Metal Paint
Interface Specification	Power Port: DC005, Data Port: USB type B
Wavelength	450nm
Engraving Area	80*80mm
Input Power	24W
Laserhead Power	3W
Image Format	JPEG/BMP/TIF/GIF
Resolution	0.05mm
Machine Voltage	12V 2A
Optimal Focus Range	30-50mm
Max Focus	100mm
Application Software	Computer Software, Phone APP Engraving Software
Gross Weight	1.65KG
Product Size (L x W x H)	167×167×165mm
Packing Size (L x W x H)	230x 230 x 165mm





# CONTENTS

01 Product Structure Diagram	01
02 Engraving Parameters	02
03 Focus Adjustment	02
04 APP Download and Installation	03
05 APP connection machine	03
06 Software Introduction	04
07 Computer software installation	08
08 Introduction to the use of software	12
09 FOA	17

## 1. Product Structure Diagram

**1** Front View

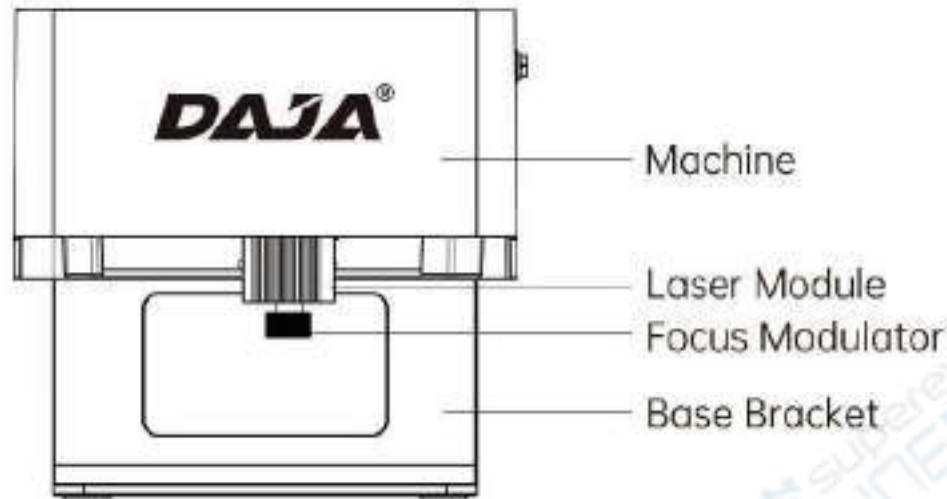

**2** Bottom View

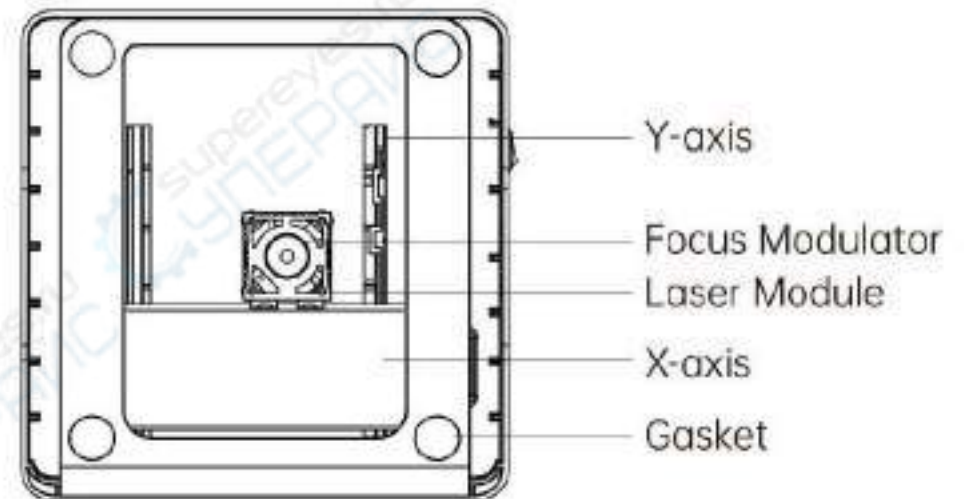

**3** Left View

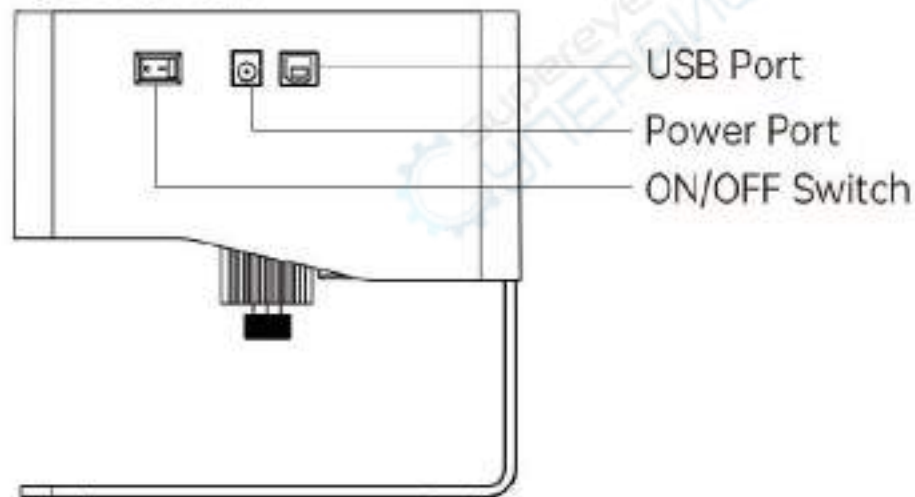

**4** Top View

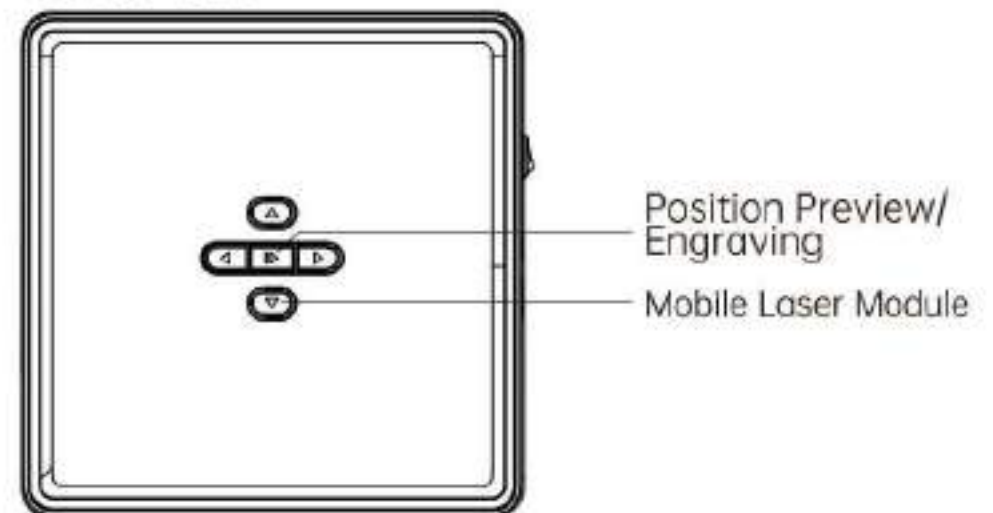

## 2. Engraving Parameters

Material	Laser Power	Engraving Depth
Leather	100	5-15
Paper	100	10-15
Plastic	100	10-20
Wood	100	10-30
Bamboo	100	15-35
Metal Paint	100	50-60

## 3. Focus Adjustment

- 1 Turn laser head left and right to form the smallest focus for higher accuracy and better engraving effect.
- 2 Optimal engraving distance: 3.5-6cm
- 3 It's most important to adjust the focus:
  1. Turn the laser head left and right to make the smallest light spot;
  2. It's optimal to keep 3.5~6 cm of distance between laser head and object surface;
  3. The focus of laser head needs to be readjusted to engrave objects of different heights.

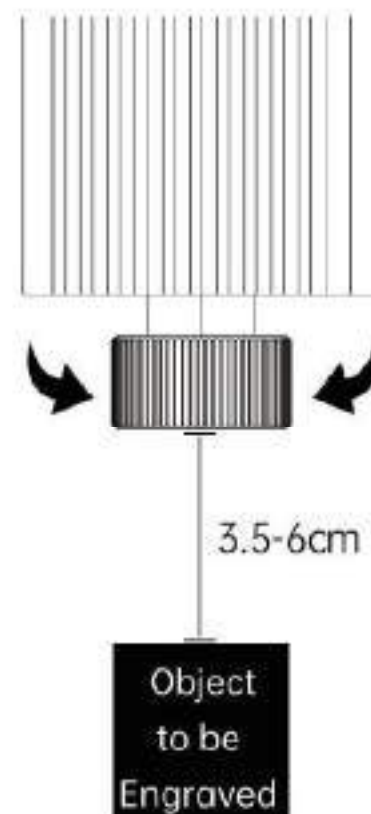

## 4. Software Download and Installation

Scan the QR code to download.



Google Play



Android



iOS

- Note:** 1. For Android system, open the browser to scan the QR code to download;  
2. Corresponding authority should be permitted after successful installation;

## 5. APP Machine Connection:

- 1 Connect the machine to power supply;
- 2 Activate Bluetooth function in the mobile phone;
- 3 Open engraving software in the phone, click "No Connection" in the upper right corner to automatically search for the device;
- 4 Then click "Engraver-000###";  
Note: "000###" represents the serial number of the machine.
- 5 Wait for 1~2 seconds till "Connected" displayed in the upper right corner, which indicates that the APP has successfully connected to the machine, then continue with the next step.

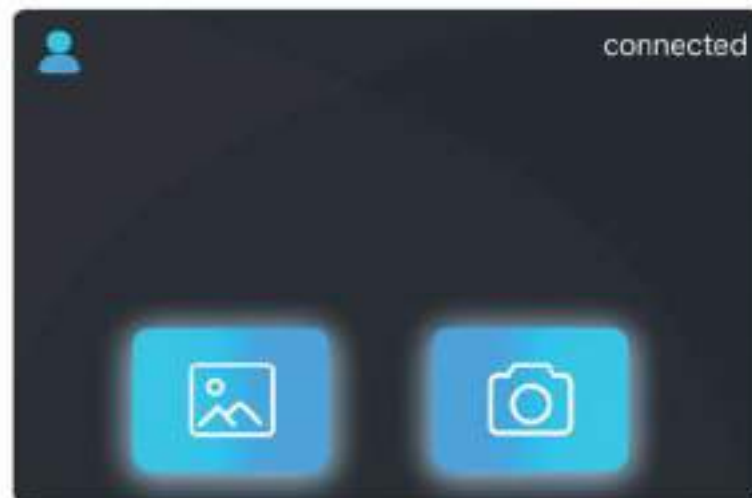



## 6. Software Interface Introduction

Introduction to software interface (loading) :

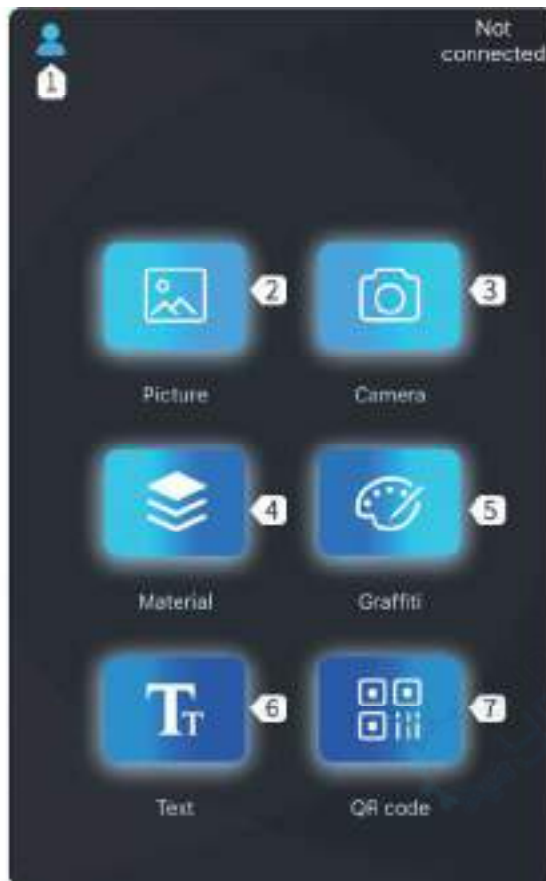



- 1 Setting**  
New User Guide/ Feedback / User Agreement and PrivacyClauses/Equipment/Language Setting
- 2 Load Photos for Engraving**  
Add photos from Album  
Add photos from Gallery
- 3 Take photos via camera**
- 4 Software Built-in Graphics**
- 5 Add Graffiti**  
Self-draw Text  
Photo
- 6 Edit Text**
- 7 Add QR code**  
QR Code,Barcode

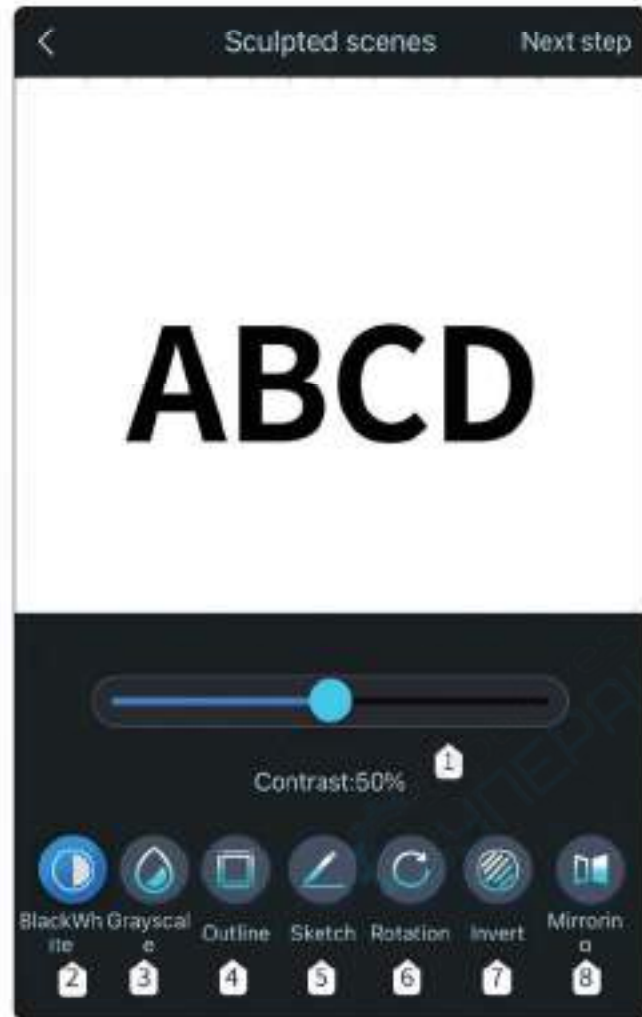

- 1 Cutting**  
Customized Cutting, Round Cutting, Square Cutting
- 2 Photo or Text**  
(Content can be superimposed)  
Input Text  
Load Photos from Album  
Shoot via Camera  
Add Photo from Material Library
- 3 Eraser**  
Modify the photo with erase

## Introduction to software interface (Loading content) :



- ① **Contrast**  
Drag the slider to adjust the contrast of text and photo  

- ② **Black and White**  
To process photos to black and white
- ③ **Grayscale**  
Grayscale mode, adopt the function for engraving photos to adjust photo grayscale
- ④ **Contour**  
Cutting mode for wireframe cutting of engraving machine
- ⑤ **Sketch**  
Sketch mode, enhance the 3D effect of photo outline  

Black and White    Grayscale    Contour    Sketch
- ⑥ **Whirling**  
Can rotate 90 degrees, 180 degrees or 360 degrees
- ⑦ **Reverse Color**  
Reverse background color of text and photo
- ⑧ **Mirroring**  
Horizontal Rotation Effect, Vertical Rotation Effect

## Introduction to Software Interface (Load Content):



- ① **Width**  
Set engraving width
- ② **Height**  
Set engraving height
- ③ **Lock Ratio**  
Scale engraving size proportionally
- ④ **Region Positioning**  
Preview Engraving Position  
Determine Engraving Position



- ① **Material Selection**  
App built-in materials, which can be directly selected based on the materials to be engraved
- ② **Add Materials**  
Add and set materials, material name/laser power/engraving speed
- ③ **Laser Power**  
Adjust power level to engrave different materials
- ④ **Engraving Speed**  
Engraving speed setting, engraving speed determines the engraving depth
- ⑤ **Repetition Times**  
It represents the number of engraving times

## Introduction to Software Interface (Load Content):



### ① Uploading content

When the transfer progress has been 100% completed, the engraving can be started.

### ② Carves Progress

Show me the progress of the sculpture

### ③ Suspend

Suspend engraving

### ③ Stop

Stop engraving



### ① Save

Save the current engraving content and view in the phone album

### ② Engraving Completed

Current content has been engraved



## 7.Computer software installation

### Software can be acquired as follows:

Method 1: Acquire the driver, software, photos and other data from the USB flash disc provided (Note: Before the use for the first time, please copy all the data from the USB flash disc to your computer as backup to prevent accidental loss due to improper operation. )

#### 1.Path to Install Driver:

Enter the USB flash disc and double click the folder:  
/01-windows/driver/Windows10\_Driver/CP210xVCPInstaller\_x64/click Install/Next/Confirm to complete the installation.

### Windows Driver Installation

① DJ6( USB flash disk)

② 01\_Windows

③ driver

④ CP210xVCPInstaller\_x64  
CP210xVCPInstaller\_x86

⑤ Please choose according to Windows versions

④ Please choose according to specific versions

⑥ Click "Next"

⑦ Click "Confirm" to complete the installation

## 2.Path to Install Software:

Enter the USB flash disk and double click the folder;/win-  
dows /software/Laser\_2.0.4(211018) / After the progress  
bar has done,the installation is completed /Laser.



⑤ After the progress bar has  
done, Laser installation is  
completed.

## Tips:

After clicking Laser\_2.0.4 (211018), if anti-virus software  
or PC Manager prompts to warn the risks. Laser\_2.0.4  
(211018) file is a win system installation package. If it is  
misjudged as a suspicious file,Please select “allow all  
operations” to complete the software installation.

## 3.Online Operation:

Connect the machine to the computer with data cable  
Double click the software icon — click the “connect device”  
icon — the icon turns blue to complete the online connection



① Double click the  
software icon



② Click the “connect  
device” icon



③ The icon turns blue to  
complete the online  
connection



## Mac Driver Installation



①



③



④ Click to continue



⑤ Click to continue the installation



⑧ Complete the installation



②

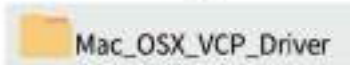

④



⑥ Enter the computer password



⑦ Continue the installation

### 1.Path to Install Driver:

Path to Install Driver: Enter the USB flash disk and double click the folder: 02\_MAC/driver/Mac\_OSX\_VCP\_Driver/Installation introduction/installation type/installation/installation completed

Note: The software can be installed after the driver has been installed, please watch the video for detailed operation.

 Video of MAC driver and software installation

## Mac software installation and online Introduction

DJ6(USB flash disk)

①

software

③



④ Double click the software icon



⑥ Complete installation

02-MAC

②



⑤ Left click the icon and drag into the Applications folder in the right

### 2. Path to Install Software:

Enter USB flash disk and double click the folder: 02\_MAC /software/Laser-2.0.4/move software icon to the right/ complete installation

### 3. Online operation:

Connect the machine to the computer through data cable  
Double click the software icon – click “connect device” icon – the icon turns blue to complete the online connection



① Double click the software icon



② Click “connect device” icon



③ The icon turns blue to complete the online connection





## 8.Introduction to the use of software

### Introduction to Icon Functions in Software Interface:

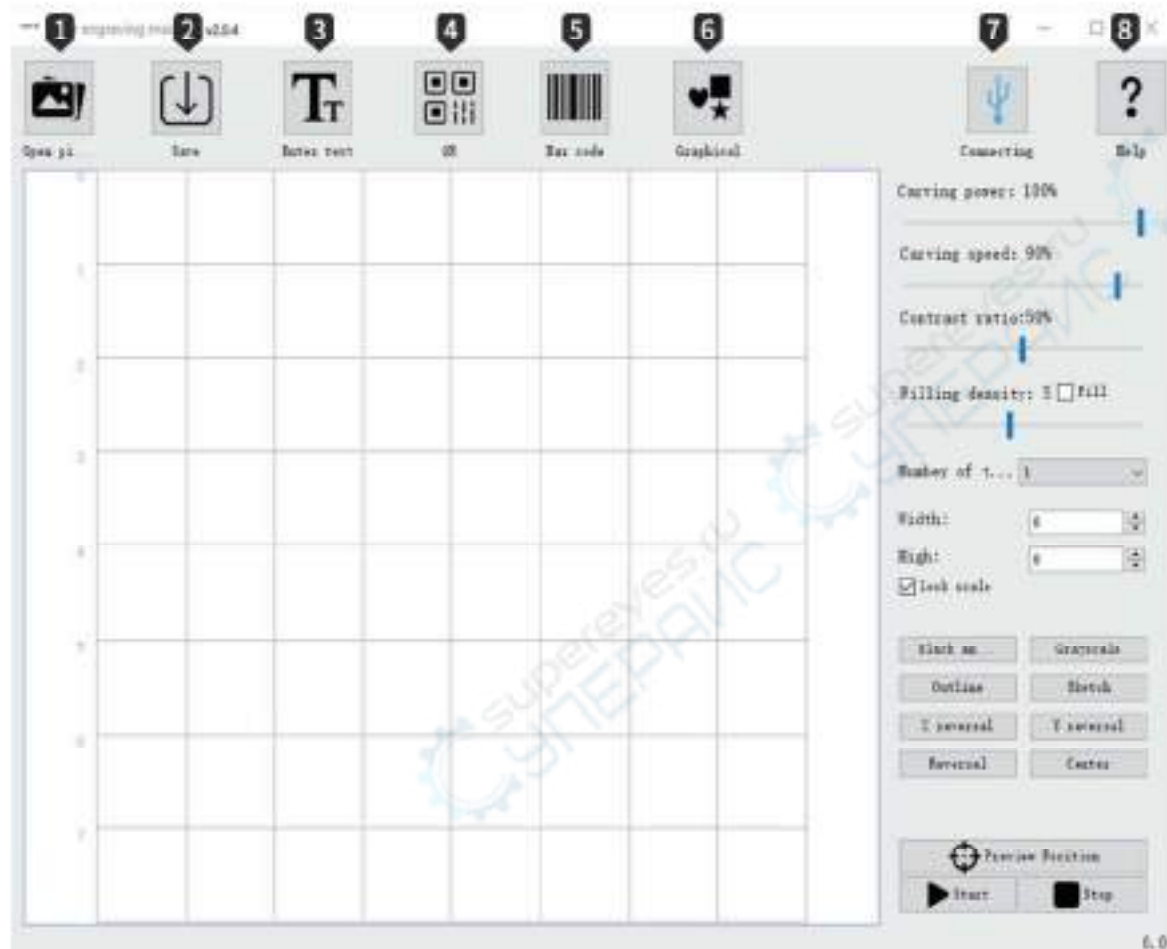

- ① **Open**  
Load photos from computer
- ② **Save**  
Save the edited texts and photos
- ③ **Input Text**  
Import text, font, size, horizontal, vertical, vectorization Editing function
- ④ **QR code**  
Create QR code
- ⑤ **Bar Code**  
Create Bar code
- ⑥ **Graphics**  
Round-square-heart-pentagon, quick creation
- ⑦ **Connect to device**  
The icon turns blue after the connection is done 
- ⑧ **Help**  
Open the link; watch the demo video and refer to the FAQ

## Setting of Software Parameters:

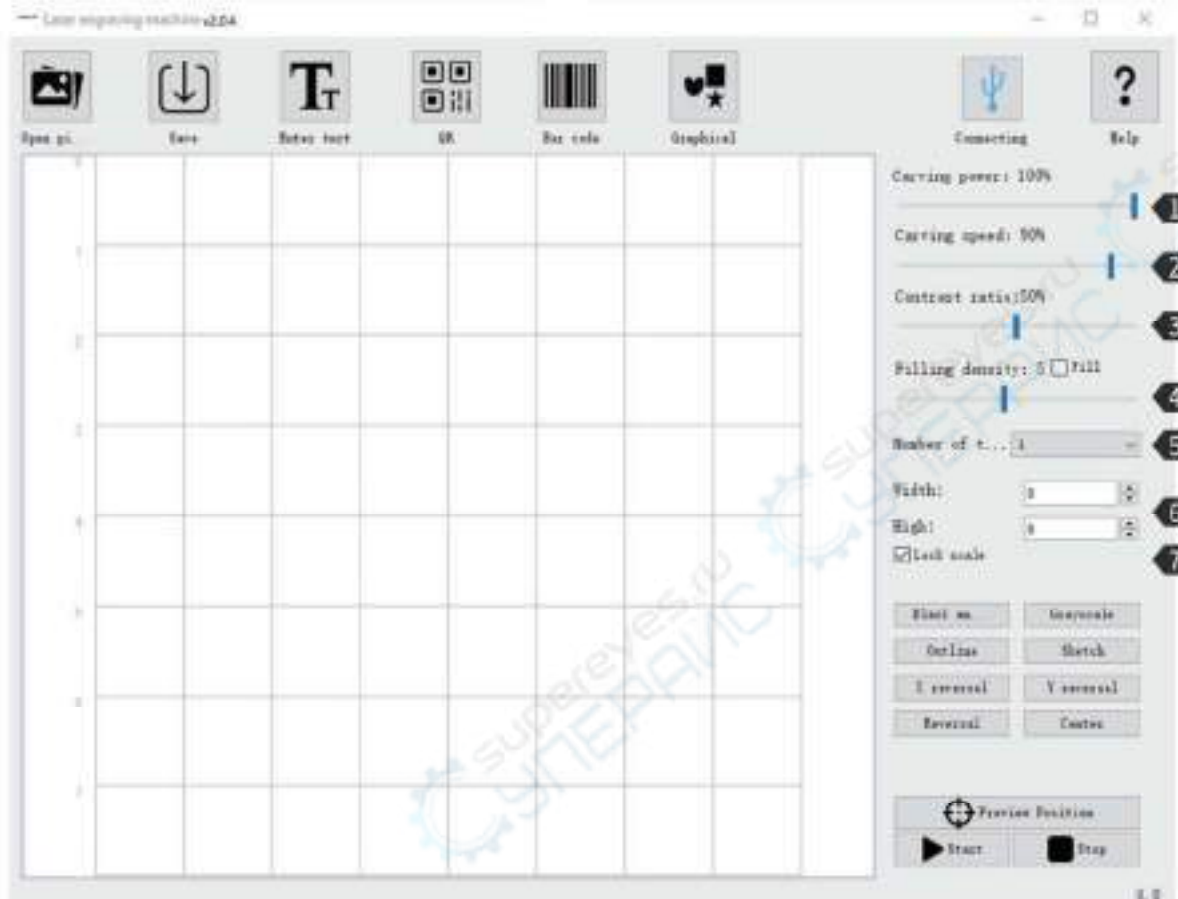

### ① Engraving Power

Adjust the power level to engrave different materials

### ② Engraving Speed

Set the engraving speed, the engraving speed of determines the engraving depth

### ③ Contrast

Drag the slider to adjust the contrast of text and photo



### ④ Filling Density; Filling

The filling effect can only be effective for vector graphics, select vectorization, Click Fill on the text photo, drag the fill slider to adjust the filling density

### ⑤ Engraving Times

Set the number of engraving times

### ⑥ Width; Height

Adjust the width and height of text photo separately at will

### ⑦ Proportional Zoom

Lock photo text to proportionally zoom in/out

## Setting of Software Parameters:

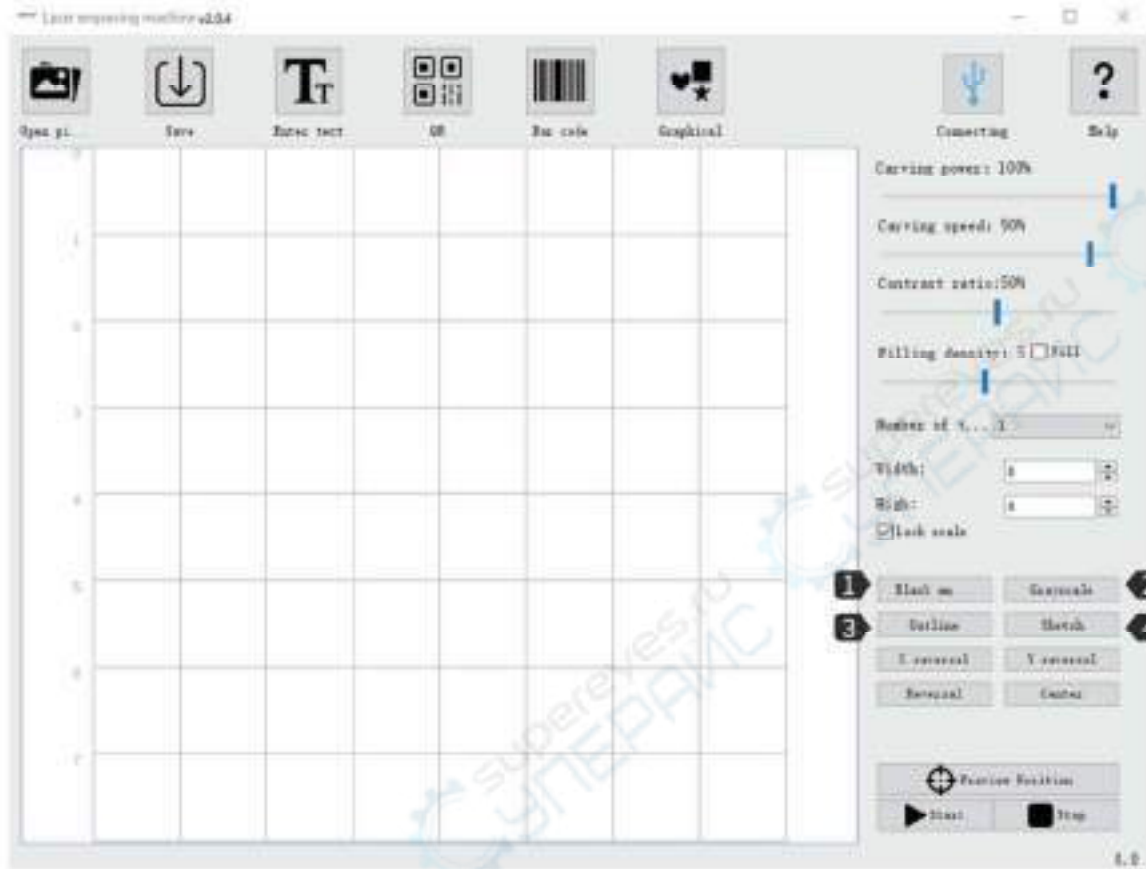

### ① Black and White

To process photos to black and white

### ② Grayscale

Grayscale mode, adopt the function for engraving photos to adjust photo grayscale

### ③ Contour

Cutting mode for wireframe cutting of engraving machine

### ④ Sketch

Sketch mode, enhance the 3D effect of photo outline



Black and White



Grayscale



Contour



Sketch

## Setting of Software Parameters:

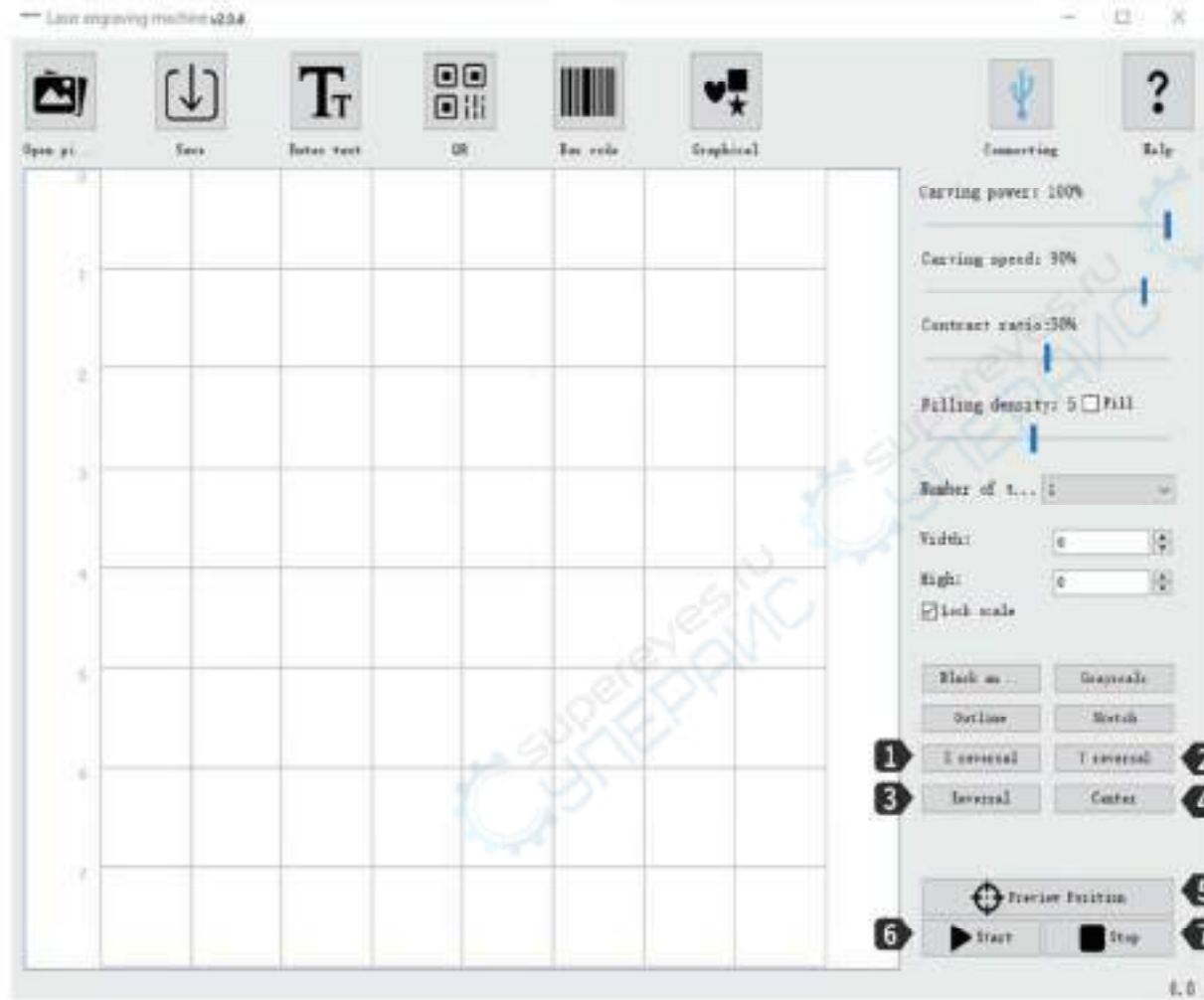

- ❶ **X Mirror**  
Horizontal Rotation Effect
- ❷ **Y Mirror**  
Vertical Rotation Effect
- ❸ **Reverse Color**  
Reverse background color of text and photo
- ❹ **Center**  
One click to center the text and photo in preview area
- ❺ **Preview Location**  
Preview to confirm engraving position
- ❻ **Start**  
Start engraving
- ❼ **Stop**  
Stop engraving



## Introduction to Interface Loading Content:

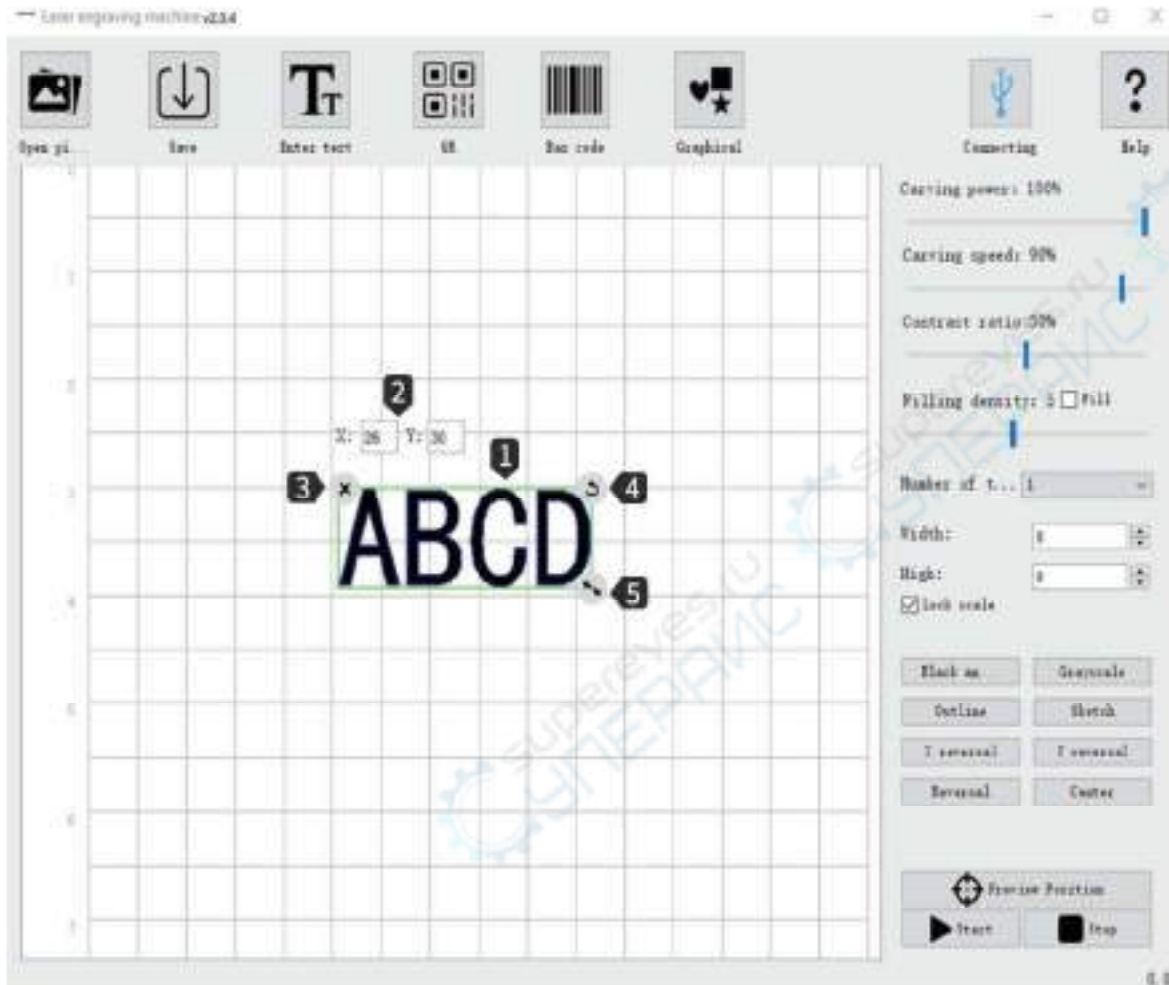

- ① After loading the text and photo, left click the mouse to move the position of the text and photo, right click the mouse to move the drawing board horizontally, roll mouse wheel to zoom in/out the drawing board.
- ② X:26 Y:30 only indicate the position coordinates where the text and photo stay; when move the text and photo, the coordinates will change based on different positions.
- ③ ✕ Clear the text and photo on the drawing board
- ④ ↻ Left click the mouse to rotate the text and photo 360°
- ⑤ ⚙ Left click the mouse and drag to zoom in/out the text and photo

## 9.FQA

### 一、 No response from the machine when being powered on.

1. No power supply: Please check the socket and switch as well as the machine power socket to ensure that they have been correctly plugged with normal power supply.

### 二、 It cannot be connected to computer

1. USB cable not connected: Please check the USB data cable interface on the machine and computer to ensure it's correctly plugged. The USB interface on the front panel of some desktop computers is invalid, it's better to connect to the interface on the back.
2. Driver not properly installed: Install the driver according to the instructions. After the installation is done, the computer will recognize the device as a serial port, which means the hardware connection is OK.
3. Other special problems: Pull out the USB data cable and power cable, keep the machine power off for 5 seconds and then try the connection once again.

### 三、 No response from the phone APP when being connected to the machine.

1. Wrong Bluetooth connection: Make sure it's connected to the Bluetooth released by the machine. Please read "App Connection" in the User Manual for details.
2. Incompatibility: In the case of abnormal connection due to incompatibility of newly-released phone or upgraded system, please contact our customer service with the screenshot of phone configuration so as to get technical support as soon as possible.

### 四、 Shallow engraving effect or no traces.

1. Inaccurate focus: Refer to the "Focus Adjustment" in the User Manual to make the correct focus.
2. Engraving speed: Too fast speed is due to short burning time. Please read the "Engraving Parameters" in the User Manual to readjust the parameters.

3. Photo color is too light: The photo added should be clear. If the line is too thin or the color is too light, the engraving effect will be directly influenced.
4. Position of object to be engraved: If the object is placed obliquely, the focal length of laser is fixed, so the object should be placed horizontally in parallel to the machine; otherwise, the inaccurate focal length will result in bad engraving effect.

### **五、Offline engraving unexpectedly stops**

1. The photo is not completely downloaded when being connected to computer, please download the photo once again.

### **六、Inaccurate focus**

1. Read the “Focus” in the User Manual. Please use the yellow focus plate provided with the camera to make the focus. If the focus plate is missing, a thin and rough yellow or white cardboard can be used as the substitution to make the focus once again. Please contact the online customer service for relevant information.

