

East Tester<sup>®</sup>

# ET3501/3502/3503/3505/3510 Operating Instructions for LCR digital electric bridge



Hangzhou Zhongchuang Electronics Co., Ltd.

## Contents

I. Installation.....	1
1.1 Unpacking and checking.....	1
1.2 Power connection.....	1
1.3 Fuse.....	1
1.4 Environment.....	1
1.5 Test fixture used.....	2
1.6 Preheating and continuous working time.....	2
1.7 Other features of the instrument.....	2
II. Introduction to the product.....	2
2.1 Main Features.....	3
2.2 Introduction to the front panel.....	4
2.3 Introduction to the back panel.....	6
2.4 Screen area.....	7
2.5 Basic Operations.....	8
2.6 Display format.....	8
III. Basic measurement.....	13
3.1 Measurement Setup page.....	13
3.2 Correction page.....	27
3.3 Limit table setup display.....	45
3.4 List Sweep Setup display.....	53
IV. System configuration.....	57
4.1 System configuration display.....	57
4.2 System configuration display.....	59
4.3 System self test.....	69
4.4 System update.....	71
4.5 Self correction.....	73
V. Save / call.....	75
VI. Technical indicators and performance test.....	81
6.1 Technical indicators.....	81
6.2 Components.....	93
6.3 General technical requirements.....	93
6.4 Performance test.....	94
VII. Instruction on the use of Handler interface.....	97
VIII. Circuit theory and formulas.....	103
IX. Notes and warranty.....	108

# I. Installation

This chapter describes the checks you should do after receiving the instrument and the condition you should know and have before the installation.

## 1.1 Unpacking and checking

Thank you for purchasing and using our products; before you use the instrument, please confirm in accordance with the last chapter “warranty” in the instructions. Please contact us if there is discrepancy so as to safeguard your interest.

## 1.2 Power connection

- (1) Voltage range of power supply: 220V.AC $\pm$ 10%,OR 110V.AC (optional) .
- (2) Frequency range of power supply: 50Hz ~ 60Hz.
- (3) Power range: less than 20w.
- (4) The input phase line L, the null line N, ground wire E of the instrument should be the same as the power plugs.
- (5) Although the instrument has been carefully designed to reduce the noise jamming caused by AC power supply input, please use it in low-noise environments; if it cannot be avoided, install the power supply filter.

Warning: To prevent the electric leakage which will cause harm to the instrument or human beings, the user must ensure the reliable connection between the ground wire of the power supply and the earth.

## 1.3 Fuse

The instrument is equipped with fuse before leaving the factory, and the user should use the fuse provided by the company.

## 1.4 Environment

- (1) Do not use it where there is dust, vibration, direct sunlight, or corrosive gas.
- (2) Normal working temperature for the instrument 0°C ~ 40°C, humidity 15-85%, so please try to use the instrument in this condition in order to ensure the accuracy of measurement.
- (3) Although the instrument has been carefully designed to reduce the noise jamming caused by AC power supply input, please use it in low-noise environments; if it cannot be avoided, install the power supply filter.

(4) If the instrument will not be used for a long time, place it in the original packing box or a similar box stored in a ventilated room with a temperature of 0°C ~ 4 °C and a relative humidity of less than 85% RH. There should be no harmful impurities to corrode the instrument, and direct sunlight should be avoided.

(5) Keep the instrument, especially the test lead wire connected to DUT away from strong electromagnetic fields, so as to avoid interference with the measurement.

## 1.5 Test fixture used

Please use the test fixture or test cable provided by the company. The test fixture or test cable made by the user or other companies might lead to wrong measurements. Keep clean the test fixture or test cable and pins of DUT to ensure the proper contact of DUT with the fixture.

Connect the test fixture or test cable to the four test ends of the front panel of the instrument—Hforce, Hsense, Lsense, and Lforce. For the DUT with shield, connect the shielding layer with the instrument's ground.

Note: an unstable measurement will be shown by the instrument without installing the test fixture or test cable.

## 1.6 Preheating and continuous working time

(1) In order to ensure accurate measurement of the instrument, the preheating time should be no less than 30 minutes; and continuous working time should be no more than 16 hours.

(2) Do not frequently switch on and off the instrument; otherwise, it would cause corruption of the internal data.

## 1.7 Other features of the instrument

- ① Power voltage: 220V.AC/50Hz  $\pm$  10%,OR 110V.AC (optional)
- ② Power consumption: <20W
- ③ Display: 7" TFT LCD, resolution 800\*480
- ④ Interfaces: LAN, RS232, GPIB, USB Host,USB Device and Handler
- ⑤ Service environment: 0°C-40°C
- ⑥ Sizes: 330mm\*285mm\*136mm (L\*W\*H)
- ⑦ Weight: 3.6 kg

## II. Introduction to the product

This chapter describes the main features of the instrument, the front and back panels, boot order and connection with the fixture.

### 2.1 Main Features

- 10Hz ~ 1MHz of test frequency
- 6 and a half digits of measurement resolution
- Internal  $\pm 2V$  of DC bias voltage
- 0.05% basic measurement accuracy
- automatic, manual, external trigger and bus trigger measurement
- dual measurement display
- measurement in absolute form or reference value based deviation measurement
- accurate four-wire fixtures
- categories of components
- up to  $\pm 60V$  of DC external bias voltage
- internal memory
- 7-inch LCD color display
- visual user interface, comprehensive test functions
- providing RS232, HANDLER, GPIB, LAN, and USB Interfaces

## 2.2 Introduction to the front panel

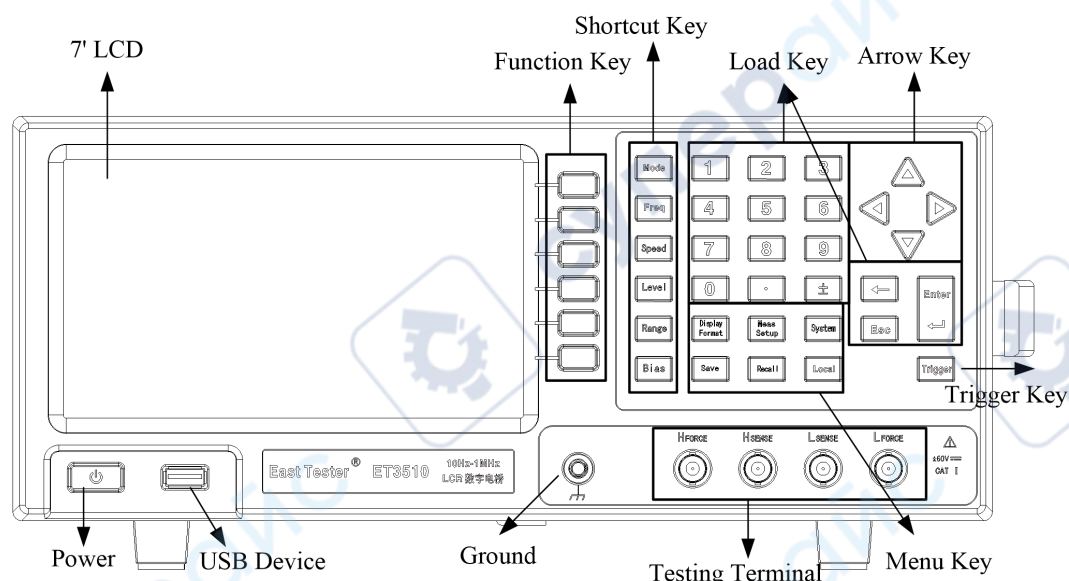

### (1) Power switch

It is used to select the status of ET35 power supply (power on or power off). When power is on, the switch is yellow-white, and all operating voltages are applied to the instrument. When power is off, the switch is dark red, and no voltage is applied to the instrument.

### (2) 7-inch color screen

7-inch color screen displays measurement results, the test conditions, etc.

### (3) Function keys

There are six function keys which are used to select the measurement conditions and parameters. There is a mark on the left of each function key.

### (4) Shortcut keys

There are six shortcut keys which are used to quickly select the measurement conditions and parameters.

[MODE] key used for the selection and setting of the combination mode of the measured objects

[FREQ] key used for the selection and setting of the measuring signal frequency

[SPEED] key used for the selection and setting of the measuring speed

[LEVEL] key used for the selection and setting of measuring signal level

[RANGE] key used for the selection and setting of range mode

[BIAS] key used for the selection and setting of internal voltage

### (5) Menu keys

Menu keys are used to obtain the appropriate selection of instrument control.

[Display Format] key display the measurement results.

[Meas Setup] key set measurement conditions, modification, limits of BIN classification and List sweep parameters.

[System] key display the system information, set system parameters, self-test, Self correction and upgrades.

[Save] key save, edit, or delete information, store measurements and screen images.

[Recall] key load or delete information.

[Local] key lock or unlock the hardware and function keys on the current panel, and change to the local mode.

#### (6) Arrow keys

The arrow keys are used to select the fields in the display page will move from one field to another. When the cursor is moved to a field, the field will be changed to the one opposite with the original video image. The cursor can only move between fields.

#### (7) Input keys

Input keys for inputting the digital data to ET35. Enter key contains the digits 0 to 9, decimal point (.), plus / minus (+/-), enter key and cancel key. Press the Enter key to terminate the numeric input; press the cancel key will nullify current input current; [←] key to delete the character pointed by the cursor.

#### (8) Trigger key

Trigger key is used to manually trigger a measurement, and the key is valid only in manual Triggering method.

#### (9) Test terminals

The test terminals are used to connect the four terminals of test fixture or test wire for measuring DUT.

#### (10) USB Interface

The USB interface can be plugged in an external USB storage device, such as the U disk, and store the data in USB memory.

#### (11) Ground terminal

The ground terminal is connected to the internal signal ground of the instrument, and can be used for the shielding of the metal housing of the external test component.

## 2.3 Introduction to the back panel

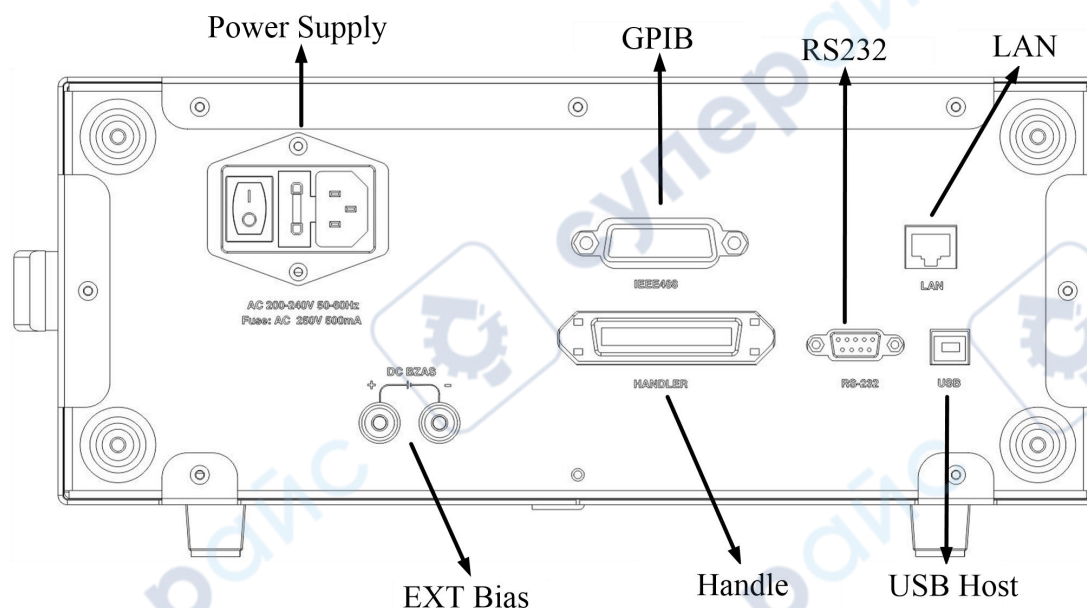

### (1) GPIB interface connector

General Purpose Interface Bus (GPIB). Connecting an external controller and other devices with the connector will constitute automatic measurement system. Note: GPIB interface of ET3501 is optional.

### (2) RS232C serial interface

With the serial communication interface, the instrument can be controlled by an external PC.

### (3) HANDLER interface connector

This interface can classify components with the automatic machine on the production line.

### (4) Ethernet interface

The interface connected to LAN (Local Area Network). Connect this instrument to the LAN, and it can be controlled by an external PC.

### (5) USB interface port

Connected to the PC's USB port. When this instrument is connected to the USB port of the PC, the PC can be controlled by this instrument.

### (6) External bias interface

The input port for the bias voltage in the external bias mode.

### (7) Power interface

To connect the socket of the power supply, use the three-phase power cord with a ground wire as provided.

## 2.4 Screen area

This section describes the name and function of each part of the 7-inch color screen of ET35.

Screen display

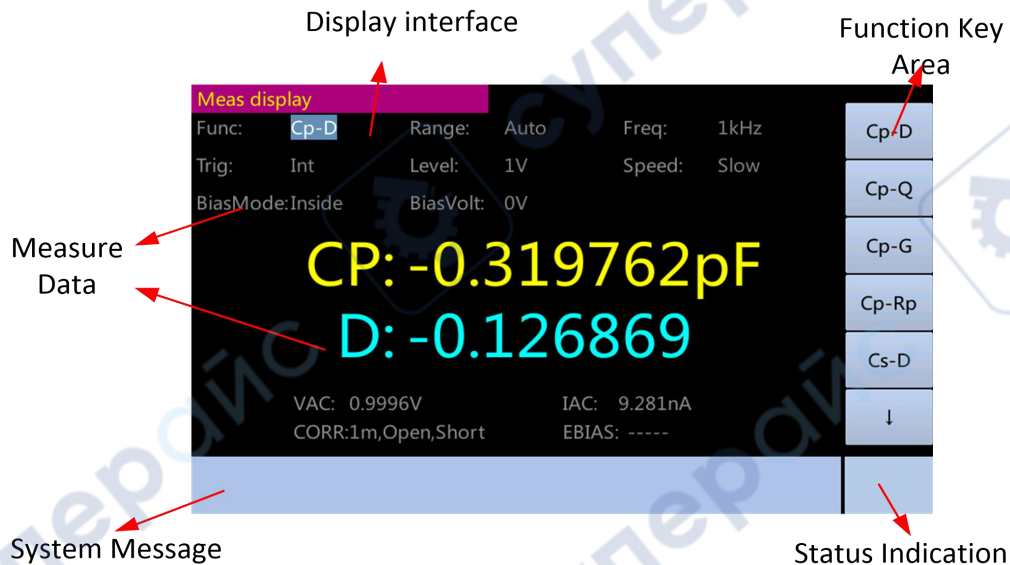

(1) Display area

It states the name on the display screen.

(2) Function key area

It shows the mark of the function key as corresponding to the field.

(3) Measurement data / condition area

It shows the current measurement condition and the measurement result.

(4) Input area

It shows the digital value input with the input key.



(5) System message area

It shows the system messages, warnings and error messages.

(6) Status Indication

It shows any status of the front panel when it is locked.

## 2.5 Basic Operations

The basic operations of ET35 is described as follows:

1. Use the menu keys and function keys to display the desired page.

2. Use the arrow keys to move the cursor to the desired field. When the cursor is moved to a specific field, the image of the field will be reversed. The cursor can move between fields. For some common parameter settings, use shortcut keys to select the desired field.

3. The mark of the function key pointed at by the cursor will be shown automatically. Press the desired function key.

Use input keys to enter numeric data. Press the next input key, and the function key will become the available unit function key. Press these unit function keys or Enter key will stop the input of the data.

## 2.6 Display format

(1) Display of component measurement

Press [Display Format] key, and the screen will show the display of component measurement. Users can set the following measurement on the display.

- function
- bias
- range
- frequency
- offset
- trigger
- level
- speed



Steps of setting the function of measurement:

1. Press the [Display Format] key.
2. Press the [Measurement Display] key.
3. Use the arrow key to select the relevant parameter field such as "function" (part of the common parameters can be set by selecting the corresponding function shortcut key).
4. Use the function key to select the required parameter. (for the option requiring number input, input the number and select with the function key).

#### (2) BIN Number Display

When you press the [Display Format] key and the [BIN Number Display] function key, the page of BIN Number display will be shown. BIN classification is shown in large character, and the measurement is shown in normal character. Users can set the measurement control on the page

Comparator function on / off

The following information is also shown in the monitoring area on the page. These conditions can be set on the measurement setting and correction setting page, and most of the conditions can be set on the component measurement page.

- function
- bias
- range
- frequency
- offset
- trigger
- level
- speed
- correction

## BIN Number Display

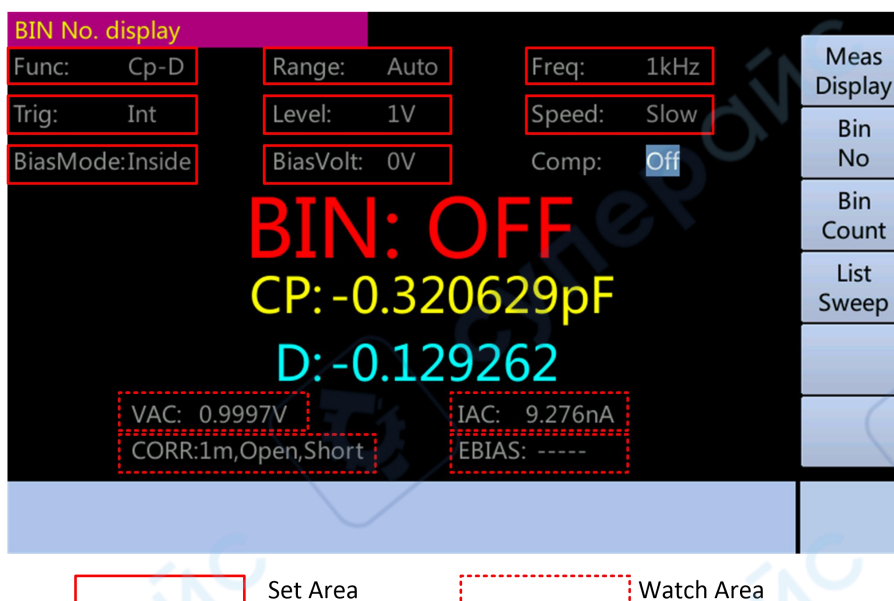

## Comparator function ON / OFF

The internal comparator of ET35 can use up to nine pairs of primary parameter limit and a pair of auxiliary parameter limit, and classify the device into up to 10 kinds (binBIN1 ~ BIN9 and OUT OF BIN). In addition, the device with its first parameter within the limit range and its auxiliary parameter measurement outside the limit range can be classified as an auxiliary BIN (AUX BIN).

To use the comparator function to control device process, HANDLER interface is required.

The above mentioned setting of limits for BIN classification can be done with the [Meas Setup] on the page of limit list. Therefore, users to compare the filed only need set the comparator function as on or off.

The step of setting the comparator function:

1. Press the [Display Format] key.
2. Press the [BIN Number Display] function key.
3. Use the arrow key to select "comp".
4. Use the function key to turn the comparator on or off.

**(3) BIN Count page**

Press the [Display Format] key and [BIN Count] function key, and the page of BIN Count will be shown. The counting result of the comparator will be shown on the page.

- count function on / off

The following information is also shown in the monitoring area on the page. These conditions can be set on the page of limit list.

- function
- nominal value

BIN Count display

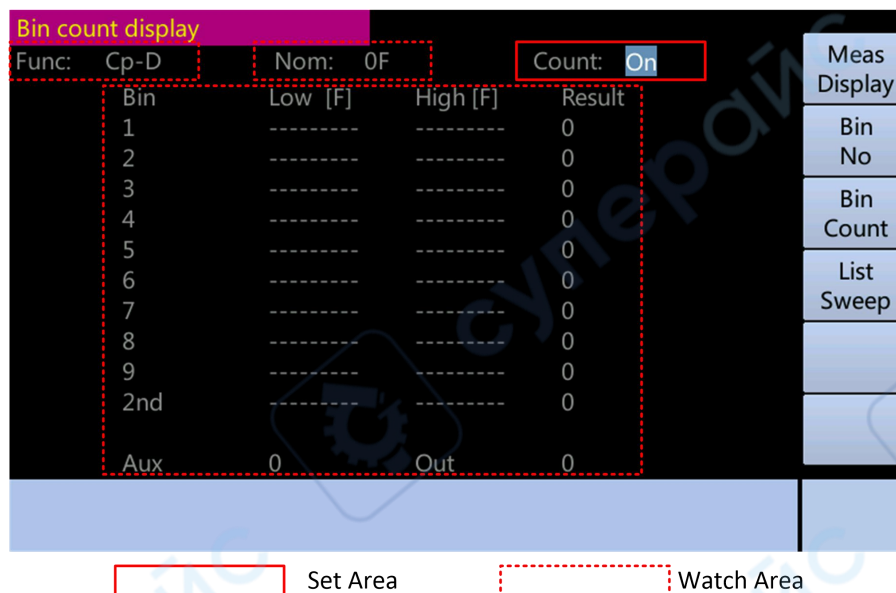

Counter function

BIN can be counted by ET35. ET35 can classify the components into the appropriate BIN with the counter function when counting the components classified into each BIN.

999999. is the limit. When the count reaches the maximum value, counting stops and the message of overflow "----" is shown.

Steps of setting the counter:

1. Press the [Display Format] key.
2. Press the [BIN Count] function key.
3. Use the arrow key to select the "count".
4. Use the function key to turn the comparator on or off.

Steps of clearing the counter:

1. Press the [Display Format] key.
2. Press [BIN Count] function key.
3. Use the arrow key to select the "Count".
4. Press the [Clear] function key.

(4) List sweep Display

When you press the [Display Format] key and [List sweep] function key, the List sweep page will be displayed. The user can observe up to 10 points of test frequencies, and measure the level or DC bias. The upper and lower limits can be set for each test point for the List sweep. These test points are automatically swept and tested; the test results will be compared with their corresponding limits. The limits cannot be set on this page but on the List Settings display.

Users can set the sweep mode on this page

List sweep Display

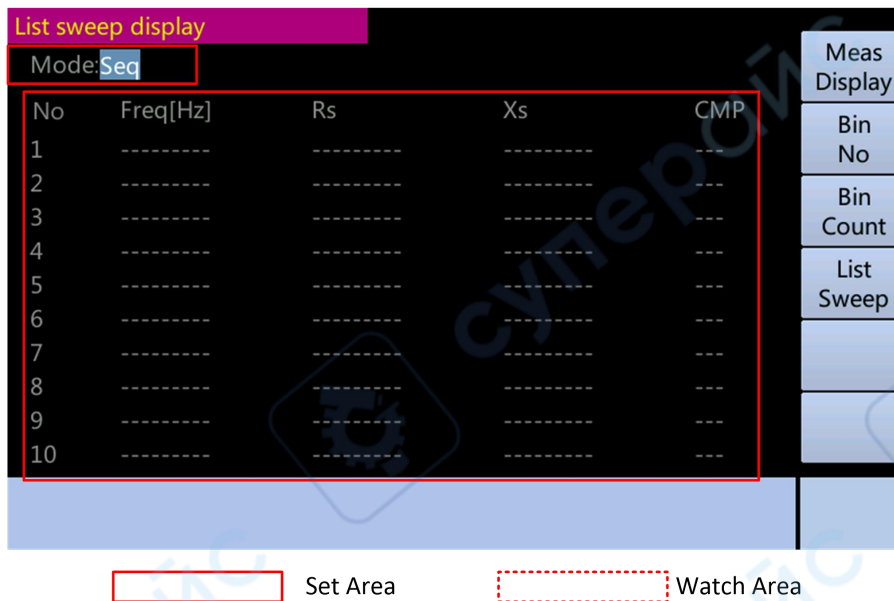

Sweep mode

The List sweep function of ET35 supports up to 100 settings of measurement frequency, test signal level and DC bias. List sweep is done in two ways: sequential mode and stepping mode. In sequential mode, every time ET35 triggers, all the sweep points are automatically swept. In stepping mode, every time ET35 triggers, the sweep points will be swept individually.

The steps of setting the Sweep mode:

1. Press the [Display Format] key.
2. Press the [List sweep] function key.
3. Use the arrow key to select "Sweep mode".
4. Use the function key to select the Sweep mode.

Note: ET35 will conduct one measurement on the component and compare the results with the corresponding limits of each point when two or more set sweep points are the same or near.

## III. Basic measurement

### 3.1 Measurement Setup page

Press the [Meas Setup] key to open the Measurement Setup page.

Measurement Setup page

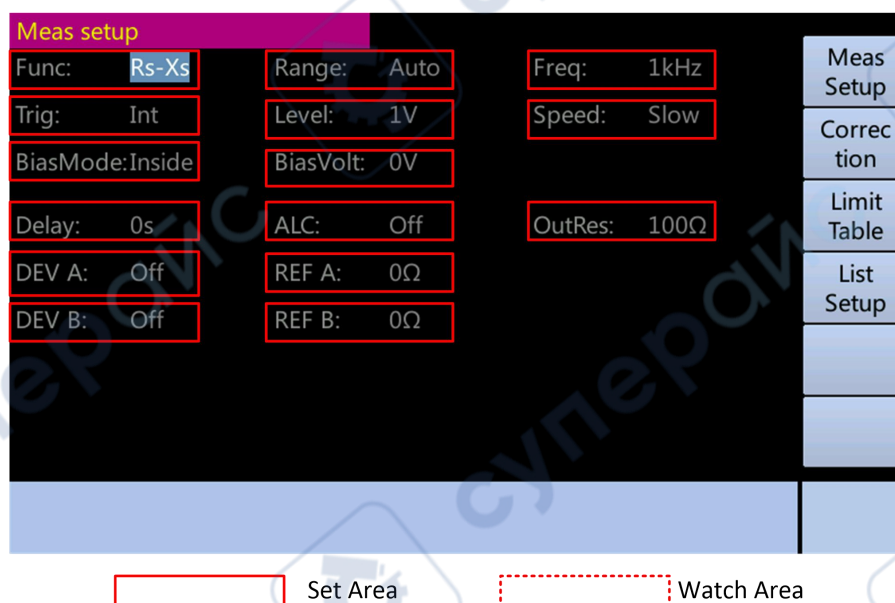

In the measurement setup page, the user can move the cursor to the corresponding field to configure all of the following measurement control functions.

- test function (function)
- option of internal and external DC bias (bias)
- test range (range)
- test frequency (frequency)
- internal DC offset value (offset)
- triggering method (trigger)
- test level (level)
- Test speed (Speed)
- automatic level control (constant level)
- delay time (delay)
- output resistance (resistance)
- deviation test A mode (deviation A)
- deviation test B mode (deviation B)
- deviation test A reference value (reference A)
- deviation Test B reference value (reference B)

Some settings on the measurement setup page are the same as the page of component measurement shown as follows.

- test function (function)
- option of internal and external DC bias (bias)
- test range (range)
- test frequency (frequency)
- internal DC offset value (offset)
- triggering method (trigger)
- test level (level)
- test speed (Speed)

### 3.1.1. Triggering method

ET35 has the following four kinds of triggering methods: INT (internal trigger), MAN (manual trigger), EXT (external trigger) and BUS (bus trigger).

When the triggering method is set to INT mode, ET35 continuously repeat the test.

When the triggering method is set to MAN mode, each time you press the [TRIG] key on the front panel, ET35 conducts a test.

When the triggering method is set to EXT mode, every time HANDLER interface receives a positive pulse, ET35 conducts one measurement.

When the Triggering method is set to BUS mode, every time ET35 receives the trigger command from GPIB, it conducts one measurement.

Note: When ET35 is testing and receives a trigger signal, the trigger signal will be ignored. Therefore it is required sending trigger signals after the test is completed by ET35.

When the HANDLER interface triggers ET35, the triggering method is set to EXT mode.

The triggering method can be set in the pages of component measurement and measurement setup.

The steps of setting the triggering method:

1. Press the [Meas Setup] key.
2. Use the arrow key to select "Trigger", and press the [Enter] key.
3. Press the corresponding function key to select the desired triggering method.

Function keys:

INT (internal trigger)

MAN (manual trigger)

EXT (external trigger)

BUS (bus trigger)

The page is shown below



### 3.1.2 Measurement Speed

The measurement speed of ET35 mainly depends on the following factors:

- integration time (A / D conversion)
- average number
- measurement delay
- measurement display time

ET35 has four different measurement speeds: slow, medium, fast and customized. The faster the speed is, the lower the accuracy is; conversely, the slower the speed is, the higher the accuracy is.

The measurement speed can be set in the pages of component measurement and measurement setup.

The steps of setting measurement time

1. Press the [Meas Setup] key.
2. Use the arrow key to select "Speed" and press the [Enter] key.
3. Press the corresponding function key to select the desired measurement time. If "Customized" is selected, then enter the proper number to set up the measurement time.
4. You can use the function key to enter the unit (us, ms, and s), press the [Enter] key to select the default unit s.

Function keys:

FAST (Fast)

MED (medium speed)

SLOW (Slow)

Customized (user-set time)

The page is shown below



Select [Customized] display

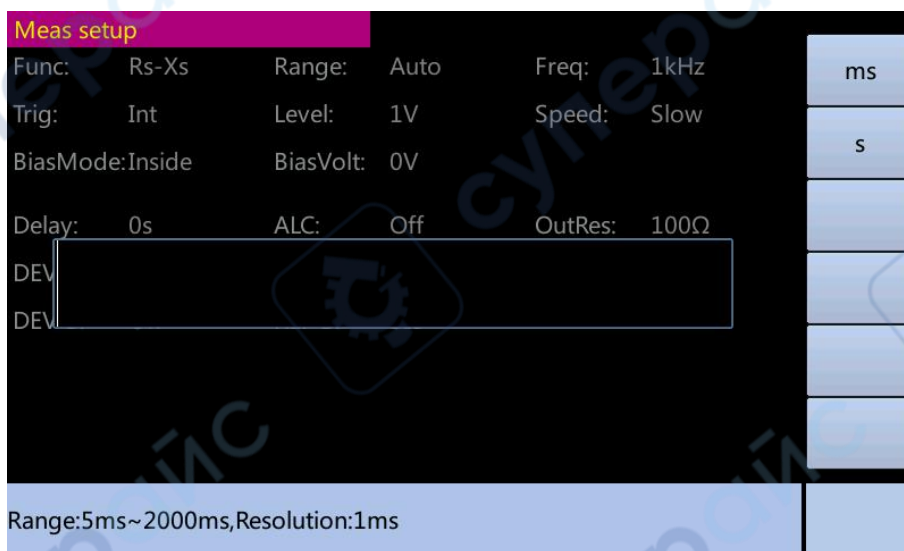

### 3.1.3 Measurement function

Two parameters of the impedance component can be simultaneously measured in each cycle by ET35: main parameter and auxiliary parameter.

Main parameters

- | Z | (impedance module)
- | Y | (admittance module)
- G (conductance)
- Ls, Lp (inductance)
- Cs, Cp (capacitance)
- Rs, (resistance)

Auxiliary parameters

- D (dissipation factor)
- Q (quality factor)
- G (conductance)
- Rp, Rs, Xs (resistance)
- $\theta_r$ ,  $\theta_d$  (impedance angle)
- B susceptance

The measurement function can be set in the pages of component measurement and measurement setup.

Steps of setting the measurement function

1. Press the [Meas Setup] key
2. Use the arrow key to select the "Function", and press the [Enter] key
3. Press the corresponding function key

Function keys: Cp-D, Cp-Q, Cp-G, Cp-Rp, Cs-D, Cs-Q, Cs-Rs, Lp-D, Lp-Q, Lp-G, Lp-Rp, Ls-D, Ls-Q, Ls-Rs, Rs-Xs, |Z|- $\theta_r$ , |Z|- $\theta_d$ , |Y|- $\theta_r$ , |Y|- $\theta_d$ , G-B.

The page is shown below

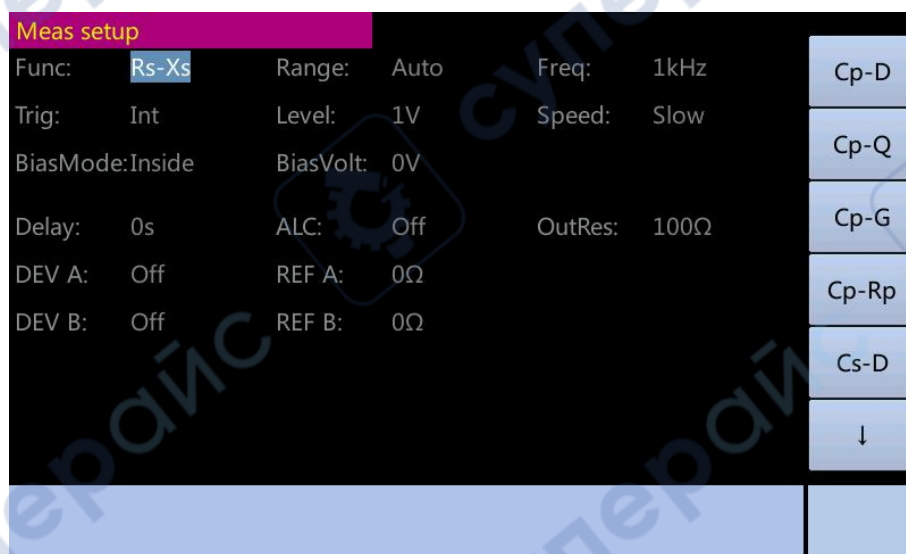

Press the [↓] function key and the page is shown below



### 3.1.4 Measurement range

Select the measurement range according to the impedance value of test LCR components.

ET35 has nine AC impedance measurement range: 30Ω, 100Ω, 300Ω, 1kΩ, 3kΩ, 10kΩ, 30kΩ, 100kΩ, and 300kΩ.

The measurement range can be set in the pages of component measurement and measurement setup.

The steps of setting the measurement range:

1. Press the [Meas Setup] key.
2. Use the arrow key to select "Range", and press the [Enter] key.
3. Press the corresponding function key.

Function keys:

Auto (auto range)

Holding (maintaining range)

↑ (increase the impedance range within the maintaining range)

↓ (reduce the impedance range within the maintaining range)

The page is shown below



### 3.1.5 Measurement frequency

The measurement frequency of ET35 can be set within the range of 20Hz ~ 1MHz with the stepping of 1mHz and accuracy of 0.01%.

The measurement frequency can be set in the pages of component measurement and measurement setup.

The steps of setting the measurement frequency

1. Press the [Meas Setup] key
2. Use the arrow key to select "Frequency", and press the [Enter] key
3. Use the numeric input key to input the measurement frequency. When using the numeric input key to input data, the function key will change to unit (Hz, KHz, MHz). You can use these function keys to enter the unit. When using the [Enter] key to input frequency, the unit of frequency default is Hz.

Note: When you enter the digital data with more than five digits (including decimal digits following the decimal point), it will be automatically set to the nearest measurement frequency.

The page is shown below

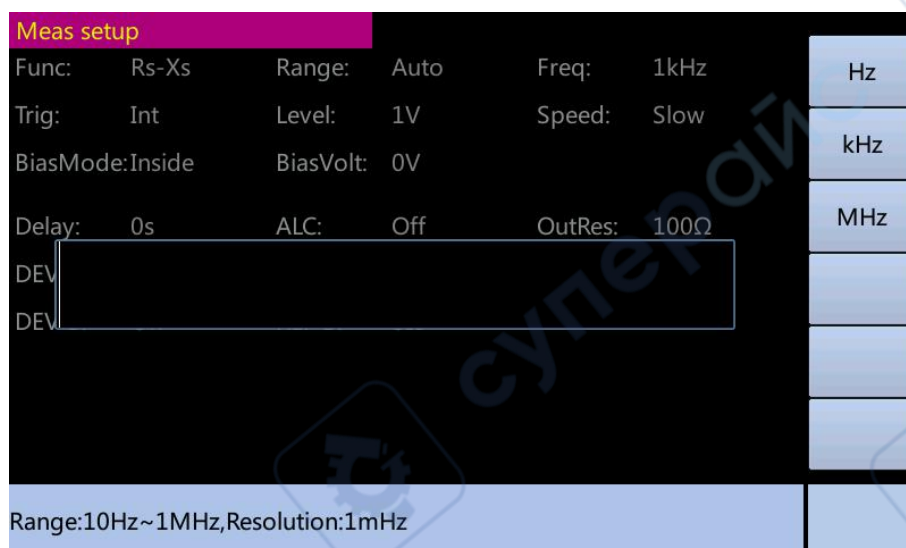

### 3.1.6 Measurement level

ET35's measuring signal level will be set according to the effective value of the measuring sine wave signal. The frequency of the sine wave signal is the measuring frequency, generated by the instrument internal oscillator. Users can either set the oscillator voltage level or the oscillator current level. Output impedance is adjustable.

Note: The measuring current of the ET35 is set as the output current value when the measured component is short circuited and the measured voltage is set to the output voltage values when the measured component is open circuited.

The automatic level control function of ET35 may achieve constant voltage or current measurements. You can then set the automatic level control function (constant level field) on in the page of measurement setup. When the constant voltage level or constant current level measurement is conducted, a "\*" sign will appear after the current level value.

ET35 has two ways to set the measurement signal level. One is to use the function keys, and the other is to use the numeric input key. The voltage level can be set within the range of 10mV ~ 2V, and the current level within the range of 100uA ~ 20mA.

The measurement level can be set in the pages of component measurement and measurement setup.

The steps of setting the measurement level:

1. Press the [Meas Setup] key.
2. Use the arrow key to select "level", and press the [Enter] key.

3. Use the function keys or numeric keys to enter the measurement level. When the data are entered using the numeric input key, the function key will change to the unit (mV, V, uA, mA). You can use these function keys to enter the unit. When using the [Enter] key to enter the level, the default unit of level is mV.

Note: you must use the numeric input key and unit function key to switch the measurement level between current and voltage.

When you enter the digital data with more than five digits (including decimal digits following the decimal point), it will be automatically set to the nearest measurement level.

The page is shown below

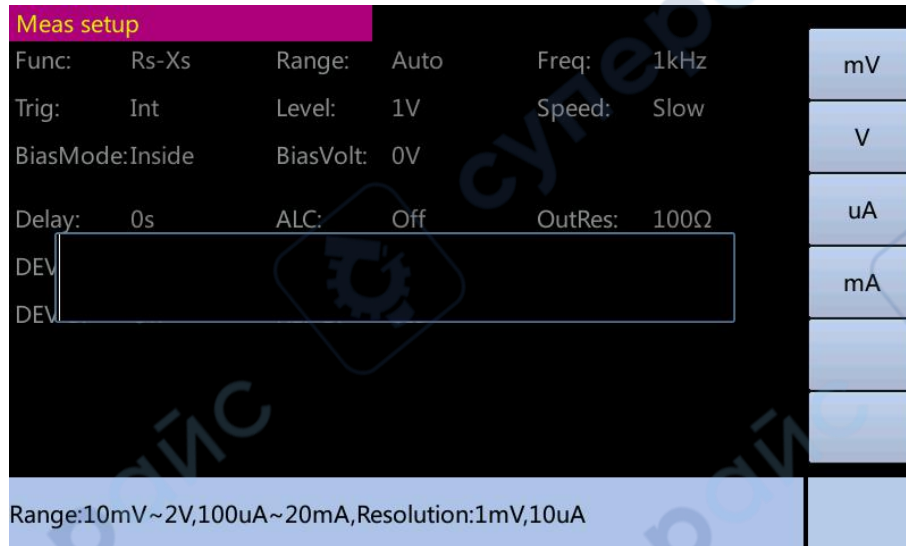

### 3.1.7 DC bias

ET35 has two ways of bias including internal and external DC bias. The range of the internal DC bias is  $-2V \sim 2V$ , and that of the external DC bias is  $-60V \sim 60V$ .

Note: the DC bias current set by ET35 is the output current value when the measured end is short-circuited, and the DC bias voltage is the output voltage when the measured end is open circuited.

The DC bias can be set in the pages of component measurement and measurement setup.

Internal DC bias setup steps:

1. Press the [Meas Setup] key.
2. Use the arrow key to select "bias", press the [Enter] key.
3. Use the function key is set to internal.
4. Use the arrow key to select the "partial pieces", press the [Enter] key.
5. Input bias level. Use the numeric input keys. Function keys become marked units (mV, V). You can use these function keys to enter the unit. When using the [Enter] key to enter the level, the level value default unit is mV.

The page is shown below

Set the bias to the internal bias



## Set the bias voltage

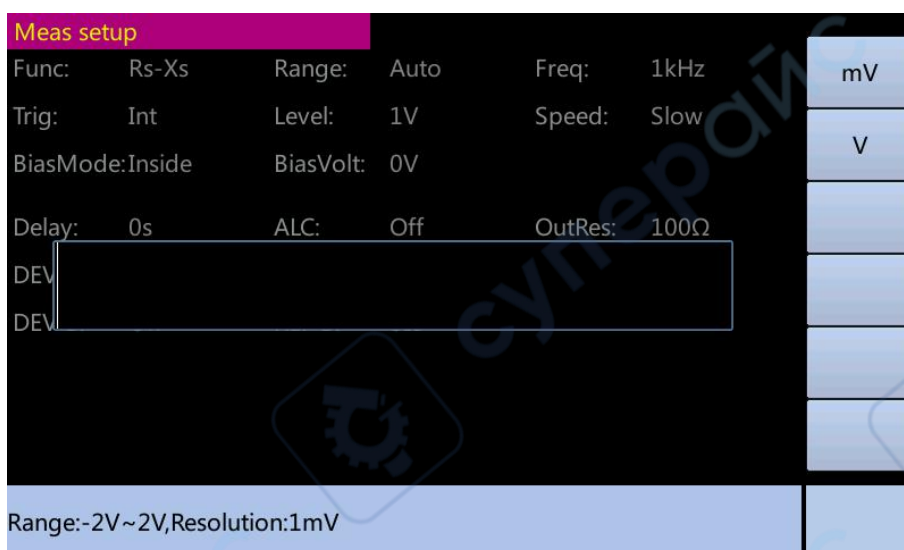

The steps of setting the external DC bias:

1. Connect the DC power to the input terminal of the external bias.
2. Press the [Meas Setup] key.
3. Use the arrow key to select the "offset", and press the [Enter] key.
4. Use the function key to set "external".
5. Press the [BIAS] key.
6. When the setup of the internal bias is successful, nothing is shown after the "bias". "DCBIAS" is displayed in the status display area.

Note: you must use the numeric key and unit function keys to switch the bias level between current and voltage. When measuring an object, reading the value after the status of the object is stable one second after the actual bias applied is preferable. Usually bias is used for capacitor. If the bias voltage is used for low impedance devices, the measurements will be inaccurate.

### 3.1.8 Automatic level control function

The automatic level control function can adjust the actual level (voltage between the two terminals of the DUT or current flowing through the DUT) to the measurement level value you set. The function is used to ensure that the measured voltage or current across the DUT is kept constant. When using the automatic level control function, the level measurement range can be limited by the following:

Setting range of the constant voltage: 10mV ~ 1V

Note: When the constant level function is active, if the set value of the level is beyond the above mentioned range, the constant level function will automatically be set to OFF. The current value of the set level is the general non-constant level values.

The steps of setting the automatic level control function:

1. Press the [Meas Setup] key.
2. Use the arrow key to select "constant level", and press the [Enter] key.
3. Press the [On] function key to open the automatic level control function.
4. Press [OFF] function key to turn off automatic level control function.

The page is shown below



### 3.1.9 Delay time

ET35 trigger delay means a delay from the time the instrument is triggered to the start of measurement. The trigger delay time can be set with the delay function. When the List sweep function is used, the set delay time at each sweep measurement point will be delayed. The setting range of the trigger delay time: 0s ~ 10s, with 1ms of stepping. When the instrument is used in automatic test system, trigger time delay function is very useful. When the instrument is triggered by the HANDLER interface, trigger delay time can ensure reliable contact of DUT with the test terminal.

The steps of setting the delay function:

1. Press the [Meas Setup] key.
2. Use the arrow key to select "Delay" and press the [Enter] key.
3. Use the numeric keys to enter the delay time, the function key will change to the unit (ms and s), you can use the function keys to enter the unit, when you press the [Enter] key to enter the delay time, the default unit is ms.

The page is shown below

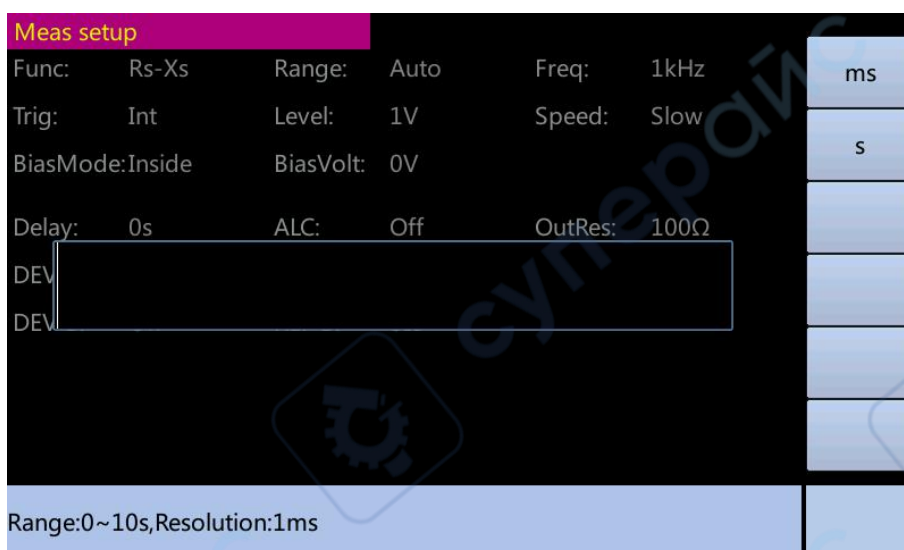

### 3.1.10 Output resistance

ET35 offers 2 kinds of selectable output resistance: 30Ω, and 100Ω. When measuring the inductance, in order to compare with the data from other types of testers, we must ensure the same value of output resistance.

The steps of setting the output resistance:

1. Press the [Meas Setup] key.
2. Use the arrow key to select the "OutRes", and press the [Enter] key.
3. Use the function keys to select the appropriate resistance.

Function keys: 30Ω, 100Ω.

The page is shown below

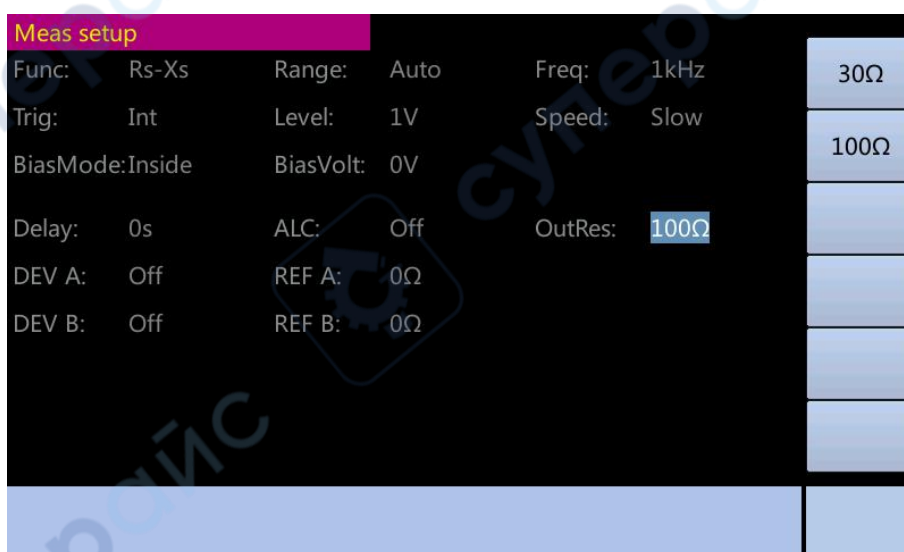

### 3.1.11 Deviation measurement function

The deviation measurement function enables the deviation value instead of the actual value to appear on the screen. The deviation value equal to the current actual measurement value less the reference value set in advance. This function is used to easily observe how the parameters of DUT vary with changes of temperature, frequency, offset and other conditions. The deviation measurement function can be used for main or auxiliary parameters, or for both the main parameter and auxiliary parameter at the same time. The instrument provides two modes of bias measurement as follows:

Delta (absolute) deviation measurement

To identify and measure the difference between the actual measurement value of the DUT and the set reference value. This value is calculated as follows:

$$\Delta = X - Y$$

X The actual measurement value of DUT

Y The set reference value

Delta% (percentage) deviation measurement

To identify the difference between the actual measurement value of the DUT and the set reference value divided by the reference value in the form of percentage. The percentage deviation is calculated in accordance with the following formula:

$$\Delta\% = \frac{(X - Y)}{Y} \times 100\%$$

X The actual measurement value of DUT

Y The set reference value

The steps of setting the deviation measurement function:

1. Select the proper measurement function.
2. Press the [Meas Setup] key.
3. Use the arrow key to select "Reference A" and press the [Enter] key.
4. Use the numeric keys to enter the main parameters of the reference value, if the reference value of the main parameter is entered using numeric keys, the function key will change to the unit, and the function key can be used to enter the unit of the reference value. When you press the [Enter] key to enter the reference value, the default unit is (mH, uF and  $\Omega$ ).
5. Use the arrow key to select "Reference B", and press the [Enter] key.
6. Use the numeric key to enter the reference value of the auxiliary parameter.
7. Use the arrow key to select the "Deviation A" and press the [Enter] key.
8. Use the function keys to select the deviation measurement method.
9. Use the arrow key to select the "Deviation B", and press the [Enter] key.
10. Use the function keys to select the deviation measurement method.

Function keys: DELTA, DELTA%, off.

The page is shown below

Set the reference value

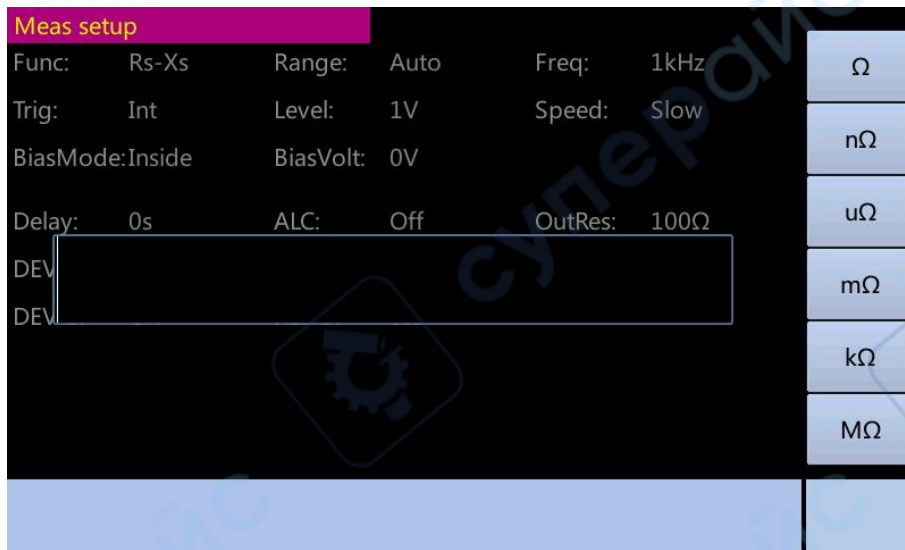

Set the mode of deviation



### 3.2 Correction page

Press the [Meas Setup] key and then press the [correction] function key to enter the user correction page. It allows the user to correct open / short / load to compensate for any errors due to interference factors such as stray admittance and residual impedance. In addition, users can also choose the proper length of cable on the correction page.

ET35 offers two correction modes. One is the use of interpolation method to correct the open / short for all frequency points. Another is to correct open / short / load for the currently set frequency points.

User Correction page

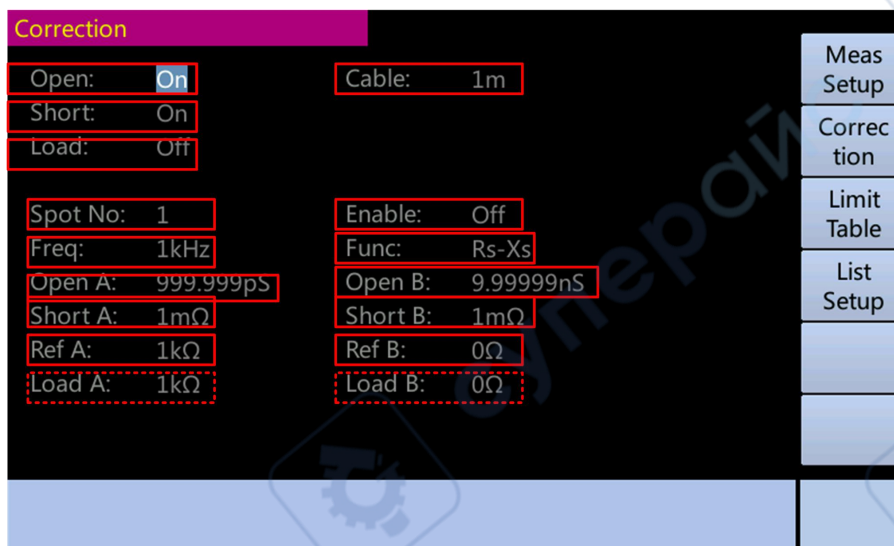

Set Area
  Watch Area

The following parameters can be set in the correction page

- open circuit correction (open)
- short circuit correction (short circuit)
- load correction (load)
- select cable length (cable)
- load correction measurement function (function)
- frequency point for open, short and load correction (frequency)
- the measurement value and reference value at the specified frequency point for open circuit, short-circuit and load correction (reference A, open A, short circuit A, load A, reference B, open B, short circuit B, load B)

### 3.2.1 Open circuit correction

ET35's open circuit correction function can eliminate the error caused by stray admittance (G, B) in parallel with the test element. Stray admittance model is as follows

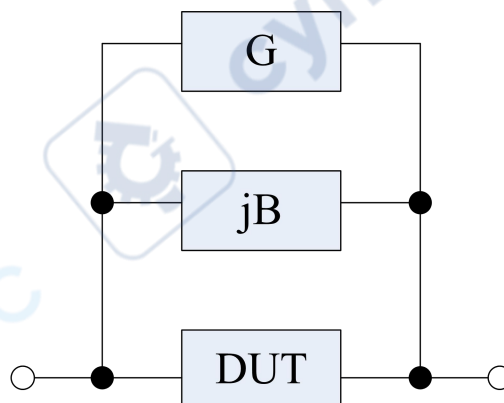

ET35 uses the following two kinds of data for open circuit correction.

First: regardless of what the frequency is set currently, ET35 will conduct the test of

open circuit correction for the following 49 fixed frequency points. In addition to the following 49 frequencies, the instrument will use the interpolation method to calculate the data of open circuit correction for different measurement range according to the data. The 49 fixed frequency points are shown below.

10Hz	100Hz	1KHz	10KHz	100KHz	1MHz
20Hz	120Hz	1.2KHz	12KHz	120KHz	
25Hz	150Hz	1.5KHz	15KHz	150KHz	
30Hz	200Hz	2KHz	20KHz	200KHz	
40Hz	250Hz	2.5KHz	25KHz	250KHz	
50Hz	300Hz	3KHz	30KHz	300KHz	
60Hz	400Hz	4KHz	40KHz	400KHz	
80Hz	500Hz	5KHz	50KHz	500KHz	
	600Hz	6KHz	60KHz	600KHz	
	800Hz	8KHz	80KHz	800KHz	

Second: ET35 only sets the open circuit correction for the currently set frequency.

The steps of open circuit correction based on all frequency points:

1. Press the [Meas Setup] key.
2. Press the [Correction] function key.
3. Use the arrow key to select "Open", and press the [Enter] key.
4. Connect the test terminal and the test fixture without connecting to any DUT.
5. Press the [Open] function key measure, and ET35 starts to measure the admittance of the open circuit at the 48 fixed frequency points.
  - When measuring, the screen displays the progress bar of open circuit measurement, and the system message area shows correcting....
  - After the measurement, the progress bar shows the unit of hours, and the system message area will show that the correction is successful.
  - When measuring, the "Cancel" function key is displayed. Press to cancel the open circuit correction.
6. Press the [On] function key to initiate the open circuit correction in the continuous measurement.

Function keys: on, off and Meas Open

The page is shown below

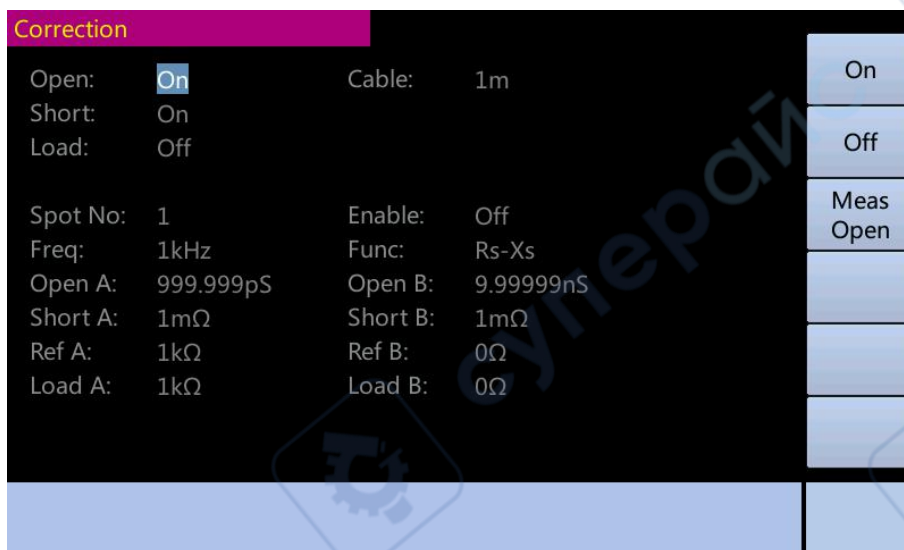

Press the [Means Open] function key, and the page is shown below

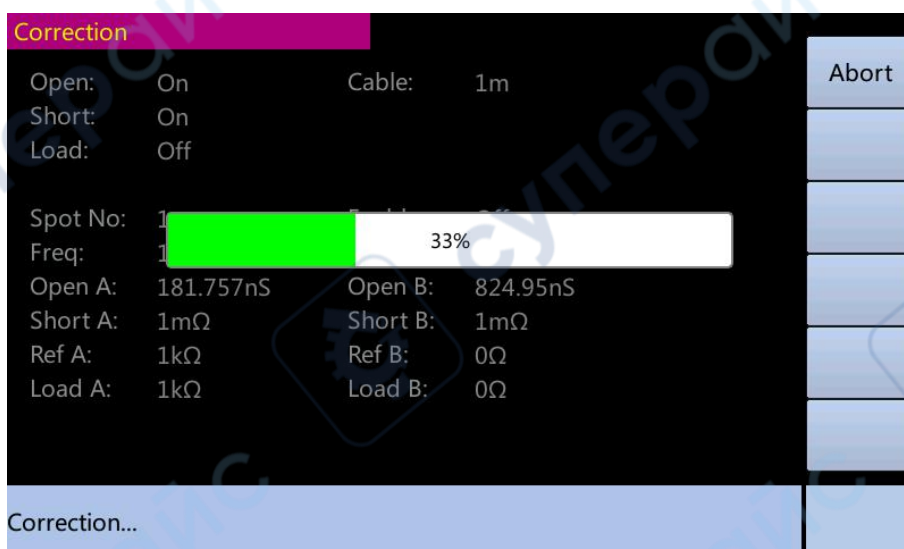

The steps of open circuit correction based on specified frequency point:

1. Press the [Meas Setup] key.
2. Press [Correction] function key.
3. Use the arrow key to select Spot No to specify frequency point.
4. Enter the number of measuring point, and press the [Enter] key to confirm.
5. Use the arrow key to select "Frequency", and press the [Enter] key.
6. Use the numeric key to input frequency, and then press the unit function key to enter.
7. Connect the test terminal and the test fixture without connecting to any DUT.
8. Press the [Open Correction] function key.
9. The correction measurement results are displayed after "open A" and "Open B".
10. Use the arrow key to select "Open", and press the [Enter] key.
11. Press the [On] function key to initiate the calculation of open circuit correction at

the specified point.

The page is shown below

Specified frequency points

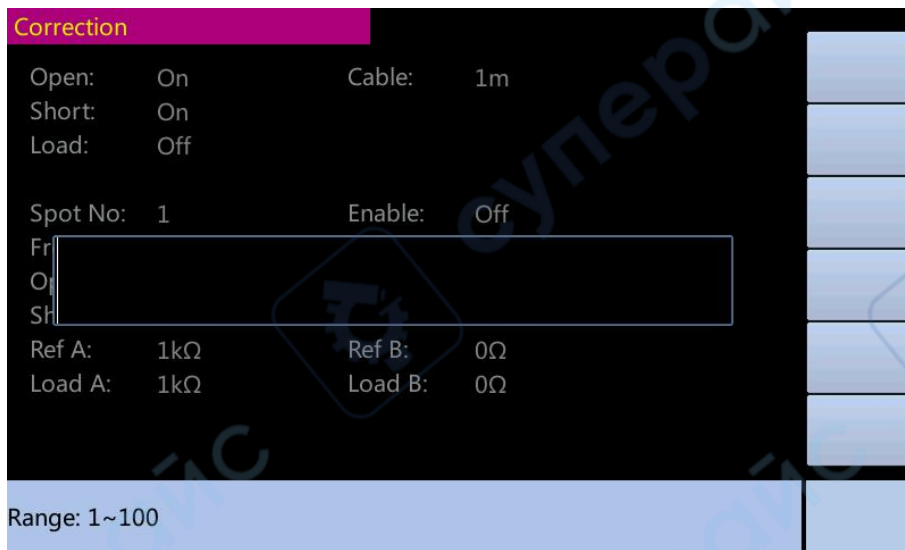

Frequency of the specified point

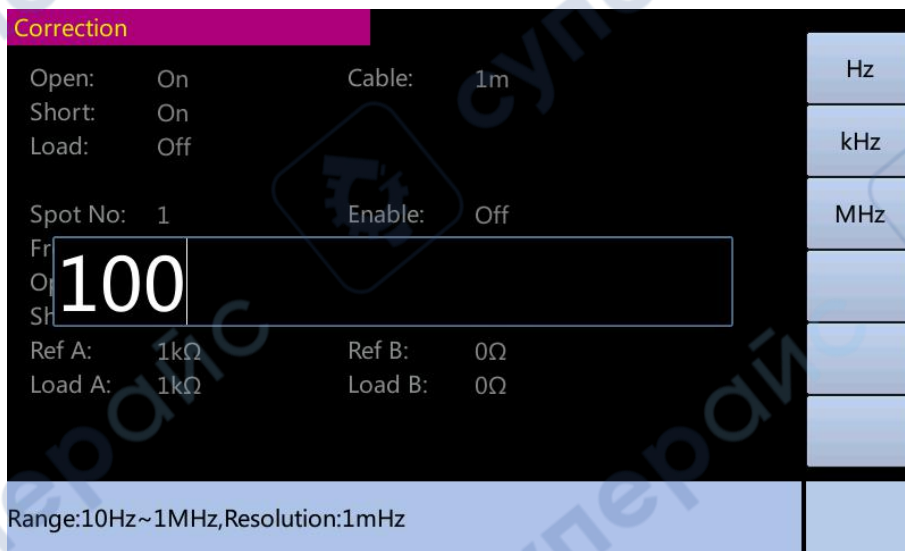

Choose open circuit correction

Correction			
Open:	On	Cable:	1m
Short:	On		
Load:	Off		
Spot No:	1	Enable:	Off
Freq:	100kHz	Func:	Rs-Xs
Open A:	181.642nS	Open B:	824.844nS
Short A:	1mΩ	Short B:	1mΩ
Ref A:	1kΩ	Ref B:	1kΩ
Load A:	1kΩ	Load B:	0Ω

Course of open circuit correction

Correction			
Open:	On	Cable:	1m
Short:	On		
Load:	Off		
Spot No:	1		
Freq:	100kHz		33%
Open A:	181.757nS	Open B:	824.95nS
Short A:	1mΩ	Short B:	1mΩ
Ref A:	1kΩ	Ref B:	0Ω
Load A:	1kΩ	Load B:	0Ω

After the open circuit of one single point ends, the measurement result of open circuit correction is shown after "Open A" and "Open B", and the page is shown below

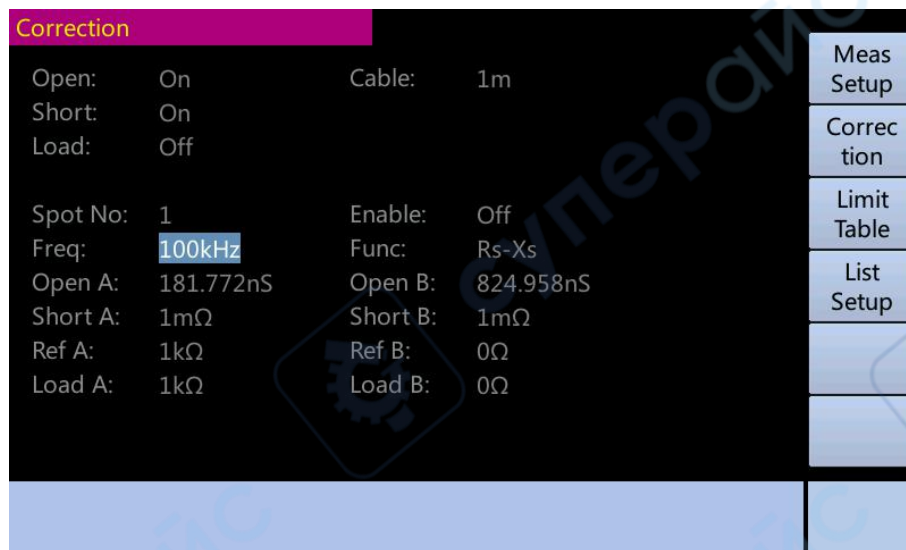

### 3.2.2 Short circuit correction

The short circuit correction function of ET35 can erase the errors caused by spurious impedance (R, X) connected in series with DUT. The model of spurious impedance is shown below

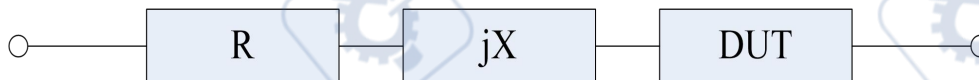

ET35 uses the following two kinds of data for short circuit correction.

First: regardless of what the frequency is set currently, ET35 will conduct the test of short circuit correction for the following 48 fixed frequency points. In addition to the following 48 frequencies, the instrument will use the interpolation method to calculate the data of short circuit correction for different measurement range according to the data. The 48 fixed frequency points are the same at those mentioned in open circuit correction.

Second: ET35 can only conduct short circuit correction for the currently set frequency.

The steps of short circuit correction based on all frequency points:

1. [Meas Setup] key.
2. Press the [Correction] function key.
3. Use the arrow key to select the "short circuit", and press the [Enter] key.
4. Short connect the test terminals and test fixture.
5. Press the [short circuit correction] function key short-circuit, and ET35 starts to measure the impedance of the short circuit at the 49 fixed frequency points.
  - When measuring, the screen displays the progress bar of short circuit measurement, and the system message area shows correcting....

- After the measurement, the system message area will show that the correction is successful.
- When measuring, the "Cancel" function key is displayed. Press to cancel the short circuit correction.

6. Press the [On] function key to initiate the short circuit correction in the continuous measurement.

Function keys: on, off and short circuit correction

The page is shown below



Press the [Meas Short] function key and the page is shown below

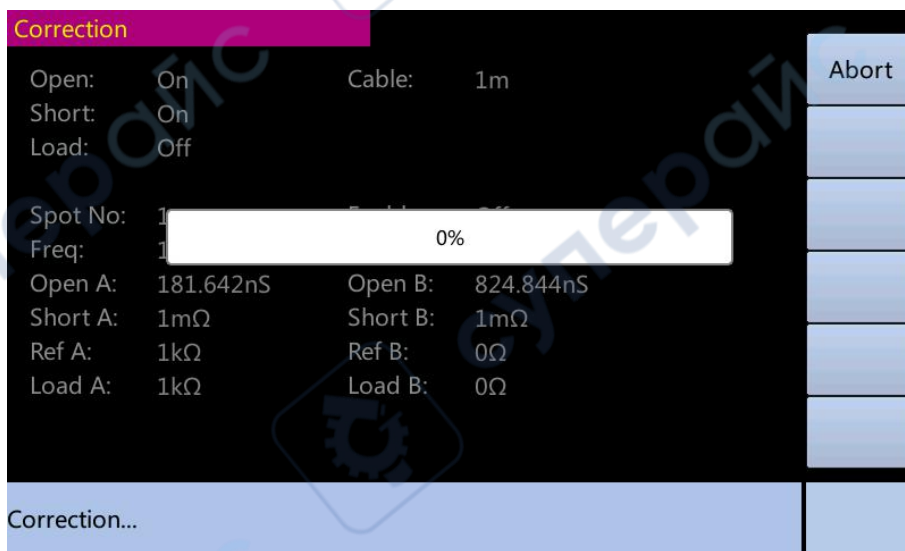

After the short circuit measurement ends, the page is shown below

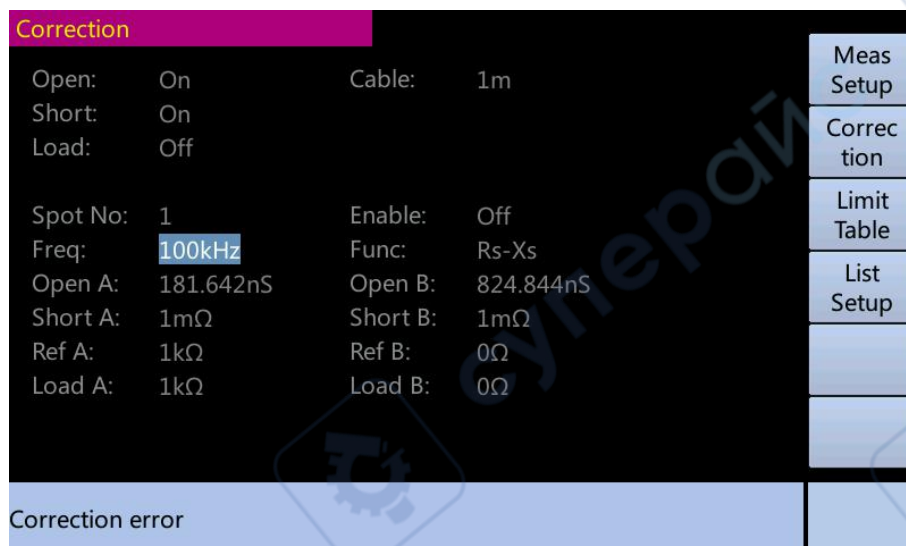

The steps of short circuit correction based on all frequency points:

1. Press the [Meas Setup] key.
2. Press the [correction] function key.
3. Use the arrow key to select Spot No to specify the frequency.
4. Enter the number of measuring point, and press the [Enter] key to confirm.
5. Use the arrow key to select "Frequency", and press the [Enter] key.
6. Use the numeric key to input frequency, and then press the unit function key to enter.
7. Short connect the test terminals and test fixture.
8. Press the [short circuit correction] function key.
9. The short circuit correction measurement results are displayed after "Short A" and "Short B".
10. Use the arrow key to select "short", and press the [Enter] key.
11. Press the [On] function key to initiate the short circuit correction calculation function.

The page is shown below

The specified frequency point

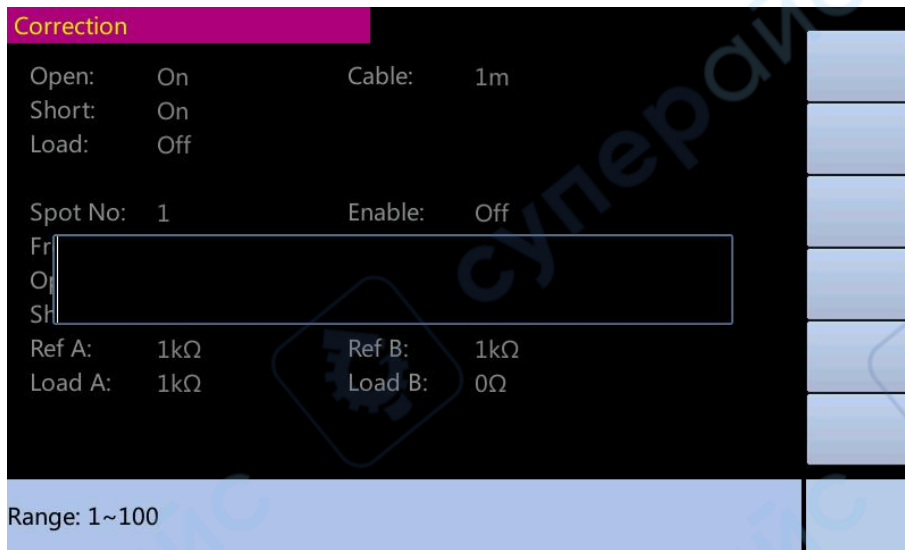

Frequency of the specified frequency point

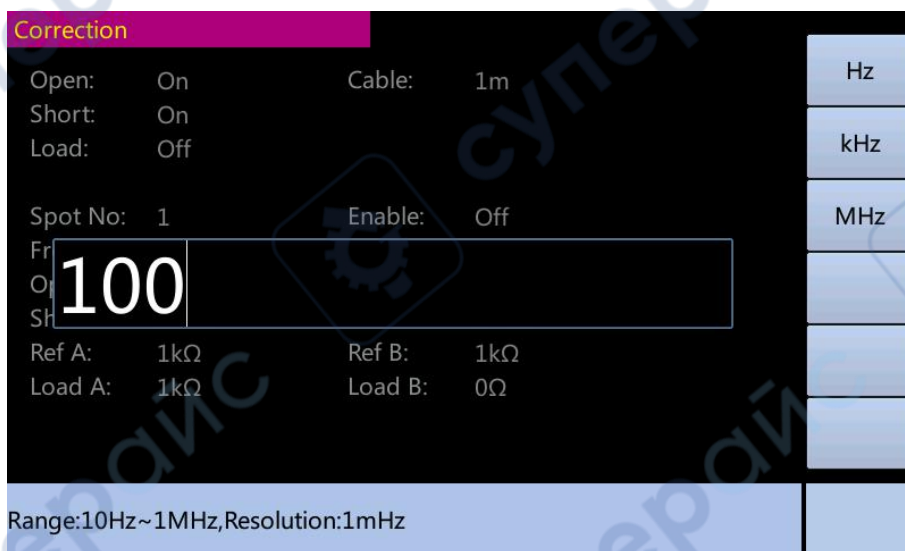

Enter 100 and press the [KHz] function key, and the page is shown below

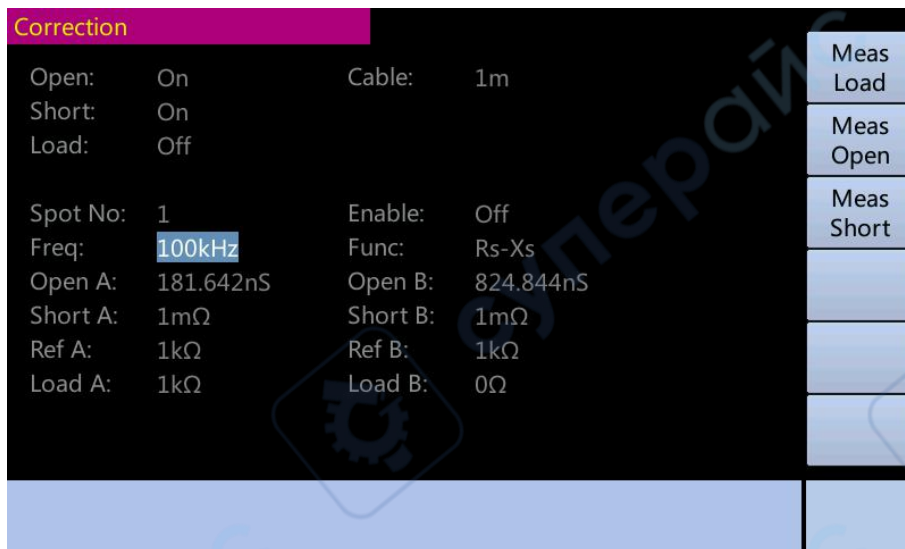

Select short circuit correction

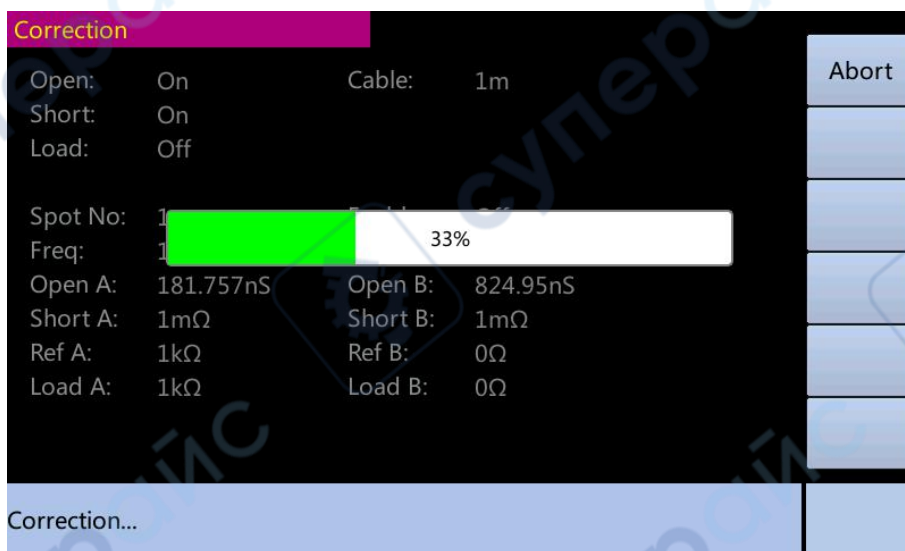

After the short circuit correction ends, the measurement result of short circuit correction is shown after "Short A" and "Short B", and the page is shown below

Correction				Meas Setup
Open:	On	Cable:	1m	Correc tion
Short:	On			Limit Table
Load:	Off			List Setup
Spot No:	1	Enable:	Off	
Freq:	100kHz	Func:	Rs-Xs	
Open A:	181.772nS	Open B:	824.958nS	
Short A:	1m $\Omega$	Short B:	1m $\Omega$	
Ref A:	1k $\Omega$	Ref B:	0 $\Omega$	
Load A:	1k $\Omega$	Load B:	0 $\Omega$	

### 3.2.3. Load correction

The load correction function of ET35 uses the transfer coefficient between the actual measurement value and the standard reference value to eliminate the other measurement errors. The standard reference value can be set at "Ref A" and "Ref B". The measurement function for the standard reference value should be set in "Function" before setting the standard reference value.

The steps of load correction:

1. Press the [Meas Setup] key.
2. Press [correction] function key.
3. Use the arrow key to select the "Function", and press the [Enter] key.
4. Use the function key to select the object to be measured.
5. Use the arrow key to select "Ref A" and press the [Enter] key.
6. Use the numeric key to enter the reference value of the main parameter.
7. Use the arrow key to select "Ref B", and press the [Enter] key.
8. Use the numeric key to enter the reference value of the auxiliary parameter.
9. Use the arrow key to select "Frequency", and press the [Enter] key.
10. Use the numeric key to input frequency, and then press the unit function key to enter.
11. Press the [Load correction] function key to conduct load correction for the currently set frequency, and the load correction measurement results are displayed after "Load A" and "Load B".
12. Use the arrow key to select "Load", and press the [Enter] key.
13. Press the [On] function key to calculate the load correction for the currently set frequency in each measurement.

The page is shown below

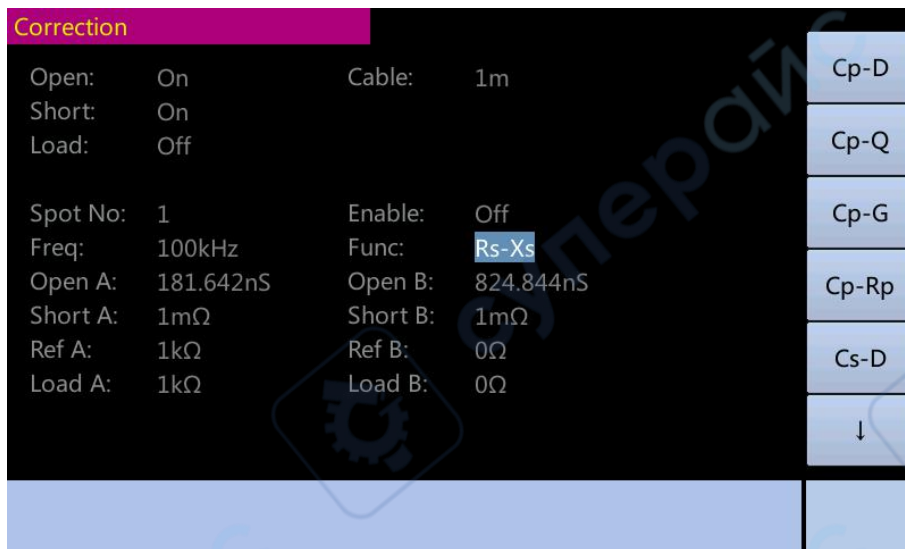

Choose the measurement function required by the user such as the Rs-Xs measurement function. Use the arrow key to select "Ref A" and press the [Enter] key, and the page is shown below

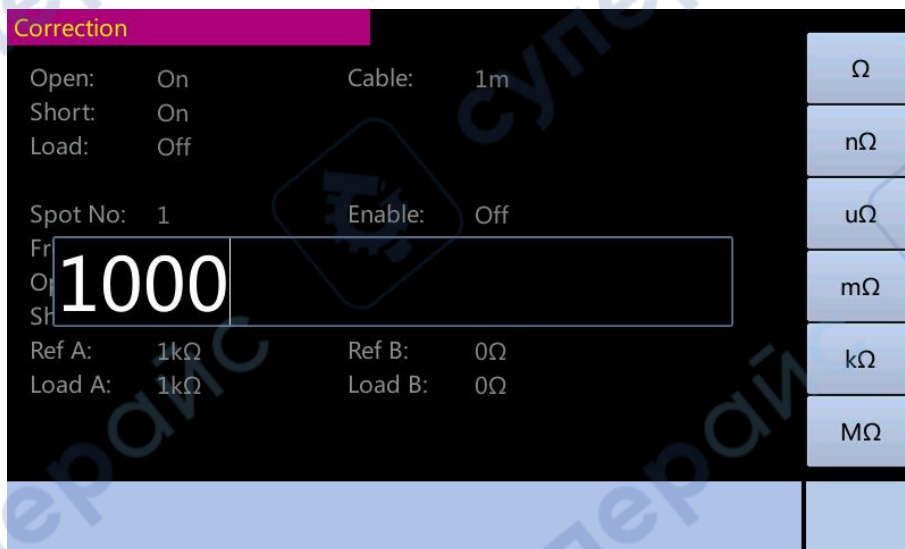



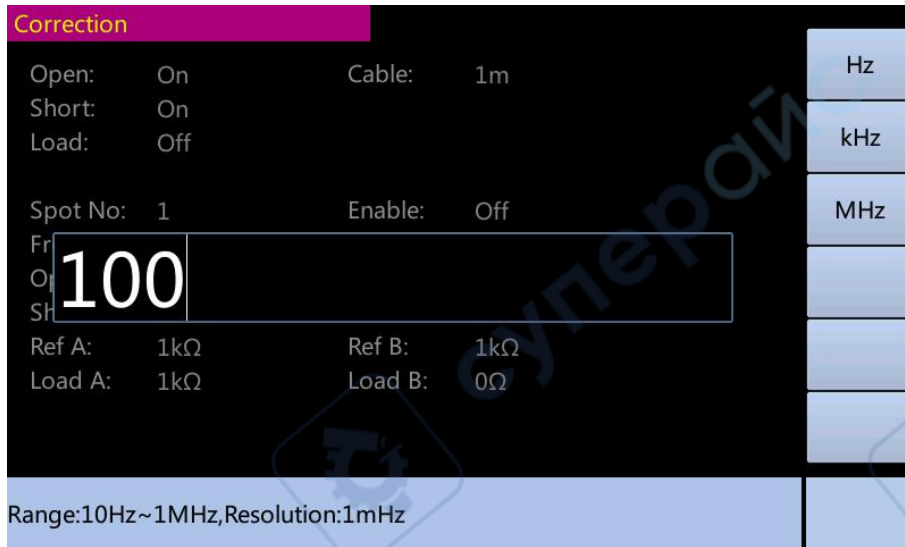

Enter 100 and press the [KHz] function key, and the page is shown below

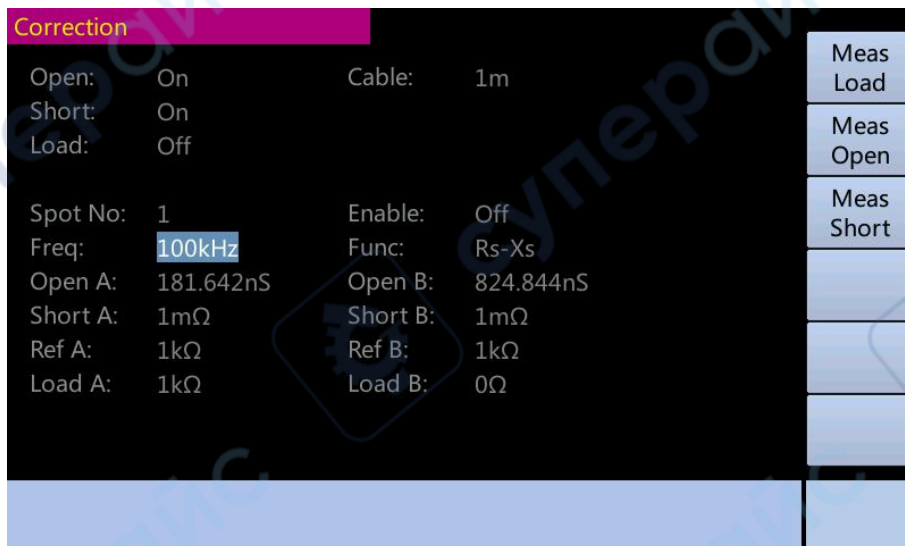

To conduct load correction

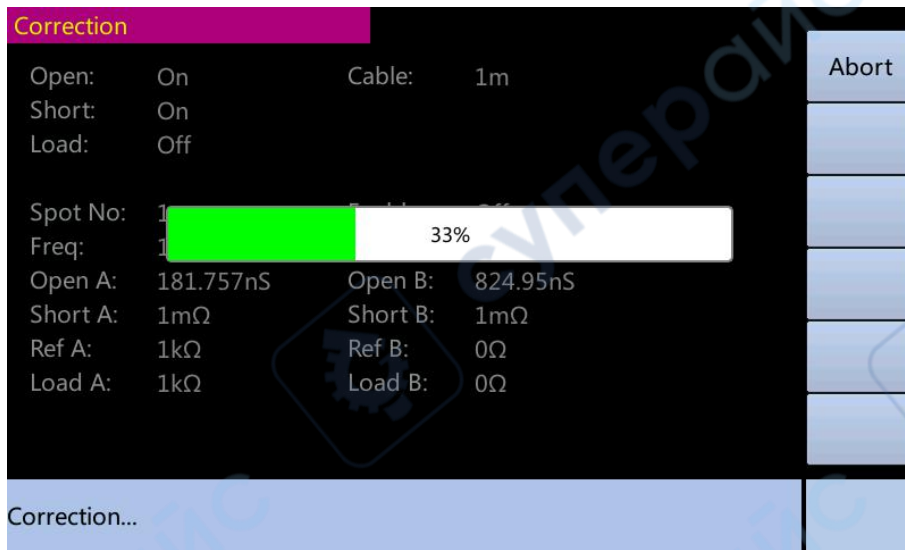

After the load correction ends, the measurement result of load correction is shown after "Load A" and "Load B", and the page is shown below

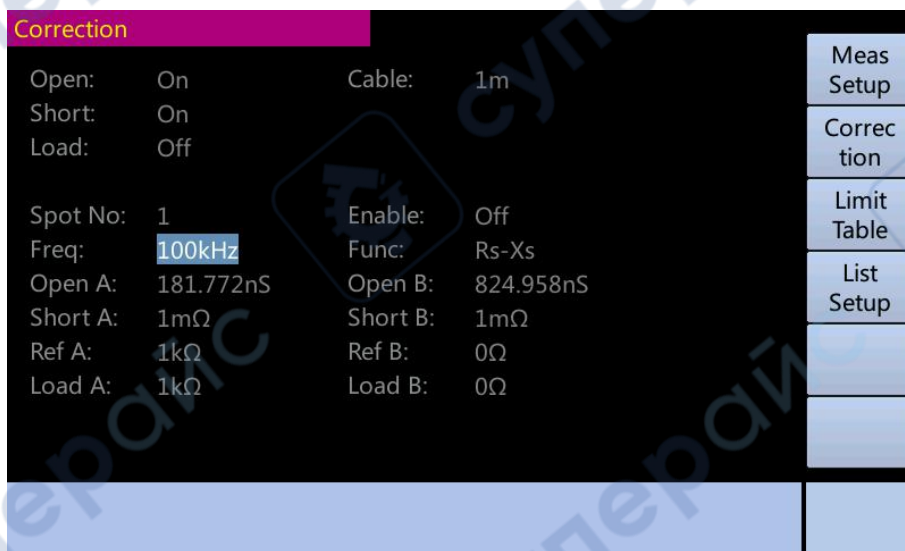

Use the arrow key to select “Load” and press the [Enter] key, and the page is shown below

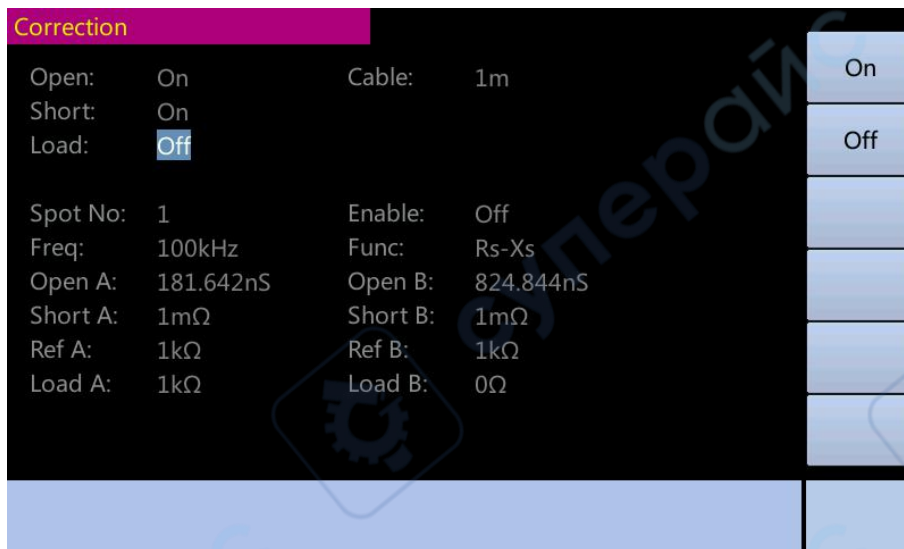

Press the [On] function key, and conduct load correction for the set frequency in every measurement, and the page is shown below

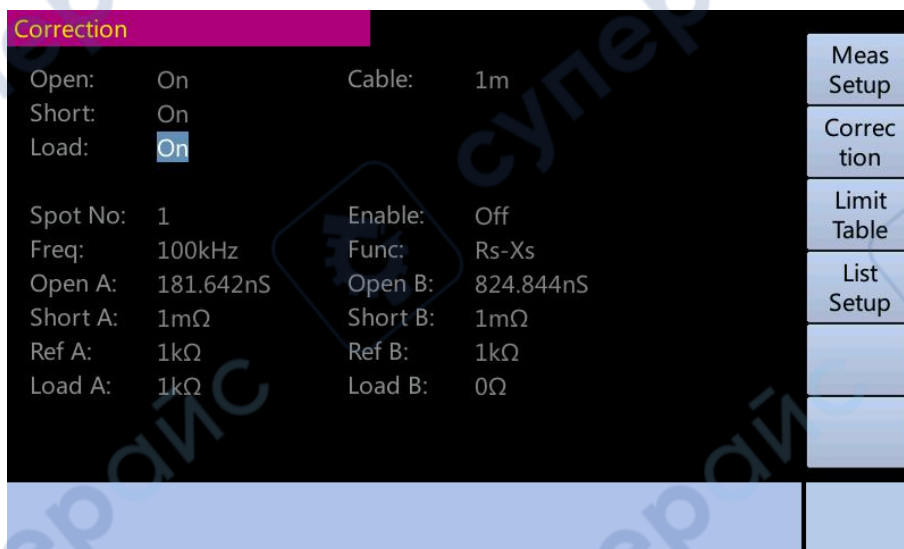

### 3.2.4 Selection of cable length

ET35 can choose from four lengths of cable: 0m, 1m, 2m and 4m.

The steps of selecting the cable length:

1. Press the [Meas Setup] key.
2. Press the [Correction] function key.
3. Use the arrow key to select "Cable".
4. Use the function key to select the appropriate value of cable length.

Function keys: 0m, 1m, 2m and 4m

The page is shown below

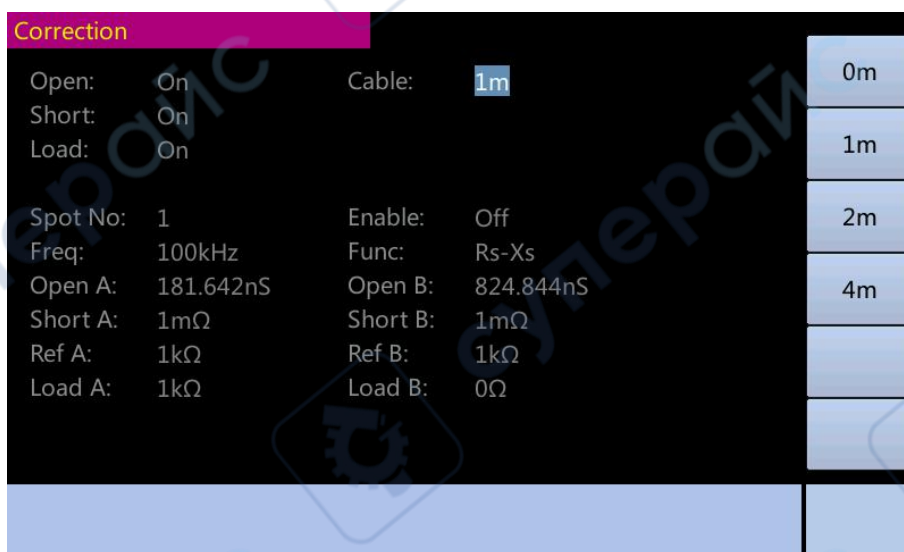

### 3.3 Limit table setup display

Press the [Meas Setup] key, and then press the [Limit] function key to enter into the limit table setup page. The limit table setup page helps users configure the built-in comparator of ET35.

Limit table setup page

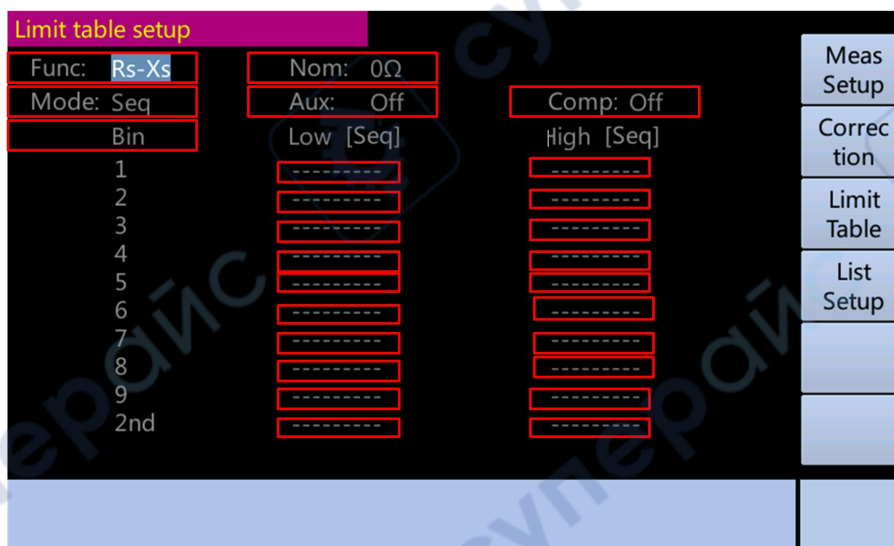

Set Area
  Watch Area

Parameters can be set on the limit table setup page

- measurement function (function)
- reference nominal value (nominal value)
- auxiliary levels (subsidiary)
- comparison function limit mode (mode)
- comparison function (compare)
- lower limit of each level (lower limit)
- upper limit of each level (upper limit)

The built-in comparison function can classify the DUT into up to 9 levels (BIN 1 to BIN8 and BIN OUT). Eight pairs of main parameter limits and a pair of auxiliary parameter limits can be set. If the main parameter of the DUT is within the limit range of the level and the secondary outside the range, then the DUT is classified into the auxiliary level. After HANDLER interface is installed on ET35, the measurement result can be output to the automatic measurement system to achieve automatic test.

### 3.3.1. Swap parameters

The Swap Parameter function can swap the main parameters with auxiliary parameters. For example, when the measurement function is: Cp-D, the swap parameters function changes the measured parameters to: D-Cp. Eight pairs of comparison limits can be set for D, and one pair for Cp.

The steps of setting the swap parameters function:

1. Press the [Meas Setup] key.
2. Press the [Limit Setup] function key.
3. Use the arrow key to select the "Function", and press the [Enter] key.
4. Use the function key to select [Swap Param] function key.

The page is shown below



Press the [Swap Param] function key, and the page is shown below

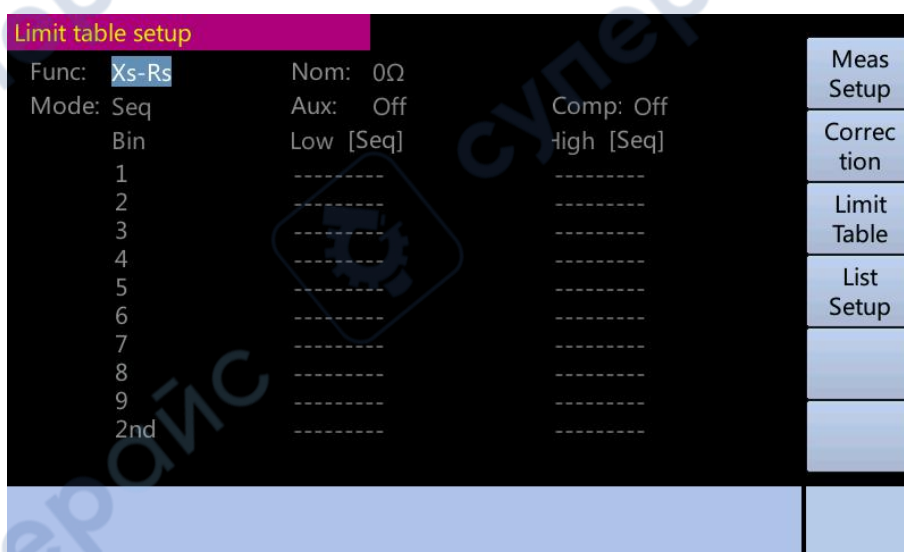

### 3.3.2. Modes of limit comparison function

Users can use one of the following two ways to specify the limit of primary parameters

- tolerance mode: in the tolerance mode, the offset value to the nominal value is set to a comparative limit. Deviation can be in two forms: percentage deviation and absolute deviation.
- sequential mode: in the sequential mode, the measurement range serves as a comparative limit. The limits must be set in the order from small to large.

Tolerance mode and sequential mode

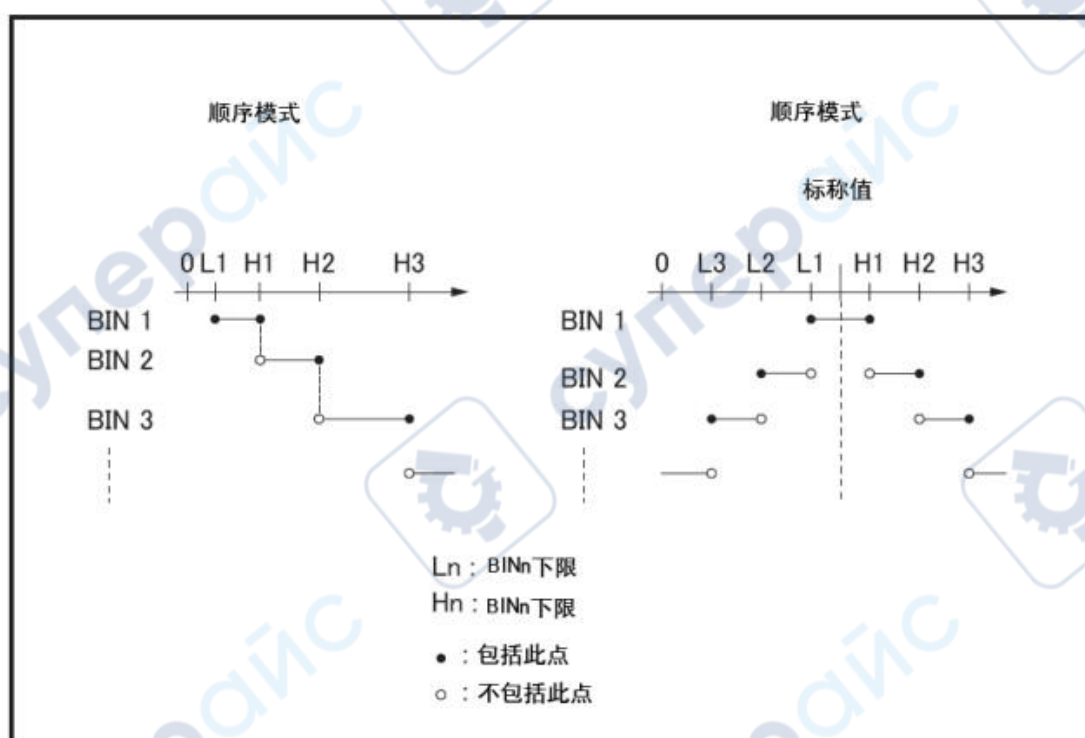

Note: When using the tolerance mode, the user must assign the minimum limit (range) to bin 1, the second narrowest range to bin2, and so on, and finally assigned the widest range to the last bin. If the range assigned to bin 1 is wider than the specified range to the succeeding bins, then all DUT are classified into bin 1.

In tolerance mode, the lower limit may not be less than the nominal value, and the upper limit is not necessarily greater than the nominal value. The ranges of each level are not necessarily continuous but can be overlapping.

The steps of setting the limit mode of comparator:

1. Press the [Meas Setup] key.
2. Press the [Limit Setup] function key.
3. Use the arrow key to select "Mode", and press the [Enter] key.
4. Use the function keys to select the limit mode required by the user.

Function keys:

DELTA switches the comparator to the tolerance mode based on absolute parameter values

DELTA% switches the comparator to the tolerance mode based on percentage of tolerance deviations

Seq switches the comparator to the sequential mode

The page is shown below

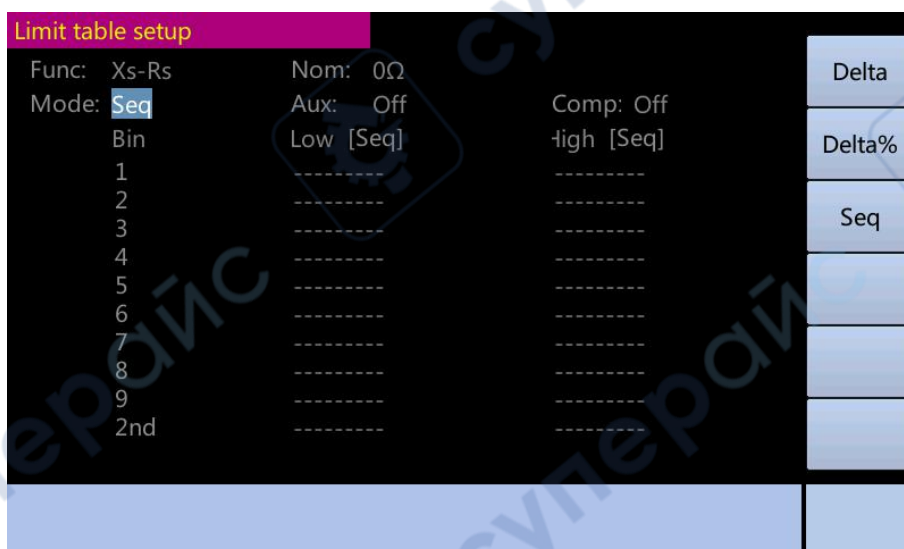

### 3.3.3. Nominal value of the tolerance mode

When the tolerance mode is used as the limit mode of the main parameter, the user must configure the nominal value.

Even if the limit mode of the main parameter is in sequential mode, the user may configure a nominal value, but it does not affect the classification.

The steps of setting the nominal value:

1. Press the [Meas Setup] key.
2. Press the [Limit Setup] function key.
3. Use the arrow key to select the "nominal value", and press the [Enter] key.
4. Use the numeric key to enter a value, and the function key will change to the unit.

The page is shown below



### 3.3.4. Turn on/off comparator

The built-in comparator of ET35 can use up to eight sets of primary parameter limits and a set of auxiliary parameter limits to classify the DUT into up to nine levels.

In addition, when the main parameter is within the limits, but the auxiliary parameter outside the limits, the DUT can be classified into one auxiliary level.

The steps of turning on/off the comparator:

1. Press the [Meas Setup] key.
2. Press the [Limit Setup] function key.
3. Use the arrow key to select "compare", and press the [Enter] key.
4. Press the [On] function key to turn on the comparator.
5. Press the [Off] function key to turn off the comparator.

The page is shown below



### 3.3.5. Turn on/off auxiliary level

If the classification results depend on auxiliary parameter (secondary parameter), the user can set the auxiliary parameter limits. Users have two ways for classification based on the auxiliary parameter.

- Assign the auxiliary parameter limits and turn off the classification of the auxiliary level

Only the DUT with the auxiliary parameter within the auxiliary parameter limits can be classified based on the comparison result of the main parameters. The DUT with the auxiliary parameter outside the auxiliary parameter limits will be classified into OUT OF BIN.

Turn off the auxiliary level

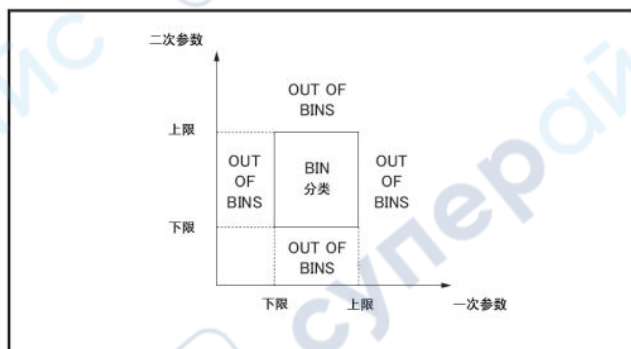

- Assign the auxiliary parameter limits and turn on the classification of the auxiliary level

The DUT with the parameter outside the main parameter limits will be classified into OUT OF BIN. In addition, when the parameters are within the limits of the main parameters, but the auxiliary parameter outside the parameter limits, the DUT will be classified into the auxiliary level.

Turn on the auxiliary level

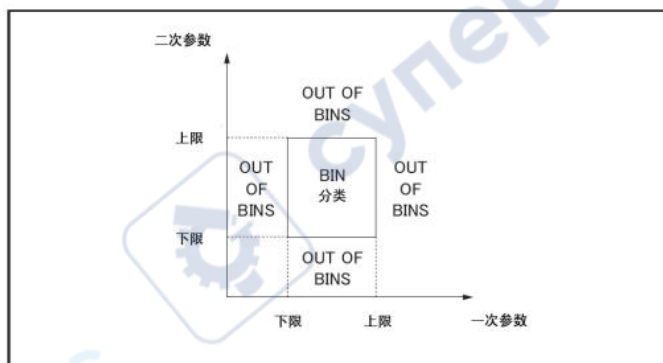

The steps of turning on/off the auxiliary level:

1. Press the [Meas Setup] key.
2. Press the [Limit Setup] function key.
3. Use the arrow key to select the "Aux", and press the [Enter] key.

4. Press the [On] function key to turn on the auxiliary level.
5. Press the [Off] function key to turn off the auxiliary level.

The page is shown below



### 3.3.6 Upper limit and lower limit

ET35 can set 8 main parameter limits and 1 auxiliary parameter limit. The test results can be classified into up to 9 levels (BIN1 to BIN8 and BIN OUT). The upper limit and lower limit of the main parameters can be set in the "Upper Limit" and "Lower Limit" from BIN1 to BIN8. The upper limit and lower limit of the auxiliary parameters can be set in the "Upper Limit" and "Lower Limit" in 2nd.

When the comparator limit is set to the tolerance mode, the lower limit set by the user must be smaller than the lower limit. If the lower is larger than the upper limit, the screen will display the warning message "Warning, incorrect upper / lower limit". If the lower and upper limits are not corrected, then the result of BIN will be zero and the comparator will turn to the next BIN to implement BIN classification.

When the comparator limit is set to the sequence mode, the limit depends on the absolute measurement value of the comparison limit. When configuring these limits, the user must first determine the minimum and then the maximum value, otherwise, the screen will display the warning message "Warning, incorrect upper / lower limit". If the lower and upper limits are not corrected, then the result of BIN will be zero and the comparator will turn to the next BIN to implement BIN classification.

The steps of setting the upper limit and lower limit:

1. Press the [Meas Setup] key.
2. Press the [Limit Setup] function key.
3. First, set up the measurement "function" in the comparison function, "nominal value" and the limit "mode" of main parameters.
4. Use the arrow key to select level 1 "lower limit", and press the [Clear Table]

function key to clear the limits. Follow steps 5 to 8 if the tolerance mode is selected; follow steps 9 to 13 if the sequential mode is selected.

5. Enter the lower limit with numeric input keys into level 1 "lower limit". After the data are entered, the function key can be used to enter the unit; when using the [Enter] key to input the limit, the default unit will be same as that of the latest one. After the limit is entered into level 1 "lower limit", the lower limit of level 1 is automatically set to - (absolute limit), the upper limit of level one is automatically set to + (absolute limit).

6. The cursor automatically jumps to level 2 "lower limit". Repeat step 5 until the limit of level 8 is entered. Then the cursor will automatically jump to the 2nd "lower limit".

7. After the lower limit of the auxiliary parameter is entered, the cursor will automatically jump to the 2nd "upper limit".

8. Enter the upper limit of the auxiliary parameter.

9. Enter the lower limit of level one with numeric input keys into the level 1 "lower limit". After the data are entered, the function key can be used to enter the unit; when using the [Enter] key to input the limit, the default unit will be same as that of the latest limit input.

10. After the lower limit of level 1 is entered, the cursor automatically jumps to level 1 "upper limit". Enter the upper limit of level 1.

11. The cursor automatically jumps to level 2 "upper limit". Because it is the sequence mode, the lower limit of level 2 is equal to the upper limit of level 1. Enter the upper limit of level 2.

12. Repeat step 11 until the upper limit of level 8 is entered. Then the cursor will automatically jump to the 2nd "lower limit". Enter the lower limit of the auxiliary parameter.

13. The cursor will automatically jump to 2nd "upper limit". Enter the upper limit of the auxiliary parameter.

The page is shown below

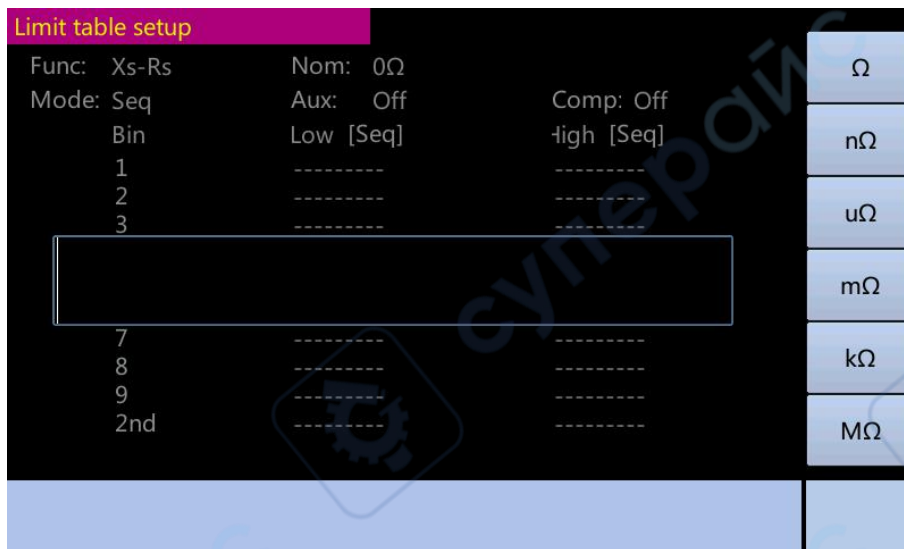

### 3.4 List Sweep Setup display

Press the [Meas Setup] key, then press the [List sweep] function key to enter into the List Sweep Setup page. The List Sweep function of ET35 can automatically sweep measure, sweep the frequency of up to 10 points, and measure the level or bias voltage.

List Sweep Setup page

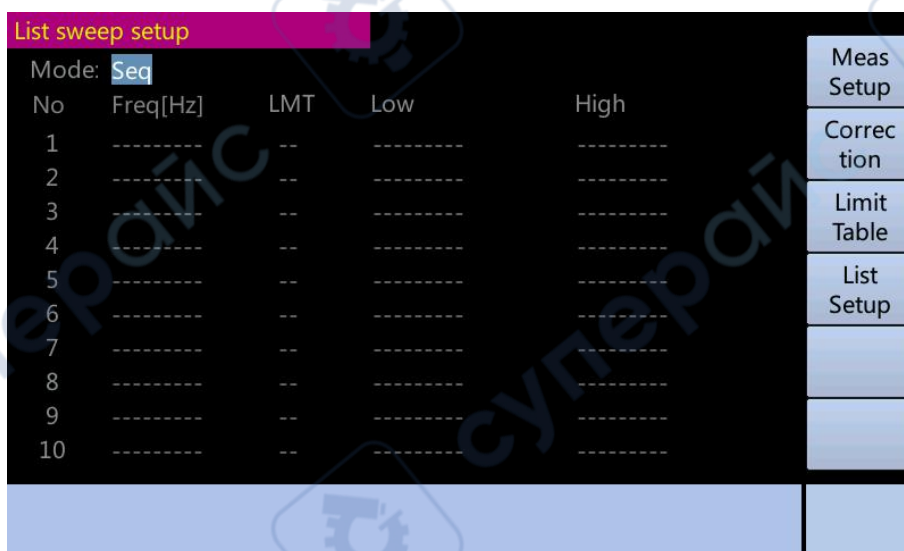

The following List sweep parameters can be set in the List Sweep Setup page.

- Sweep mode (Sweep mode)
- sweep parameter setting (frequency [Hz], level [V], level [I], bias [V] and bias [I])
- sweep measurement point setting (sweep point)
- limit parameters (LMT)
- upper and lower limits (upper limit, lower limit)

### 3.4.1 Sweep mode

The List sweep function of ET35 can automatically scan and measure. It can scan the frequency, signal level or DC bias of up to 10 points. The List sweep function supports two Sweep modes: sequential mode and stepping mode. In the sequential mode, once ET35 is triggered, it will sweep and measure all points. In the stepping mode, once ET35 is triggered, it will step to the next sweep point.

Sequential mode and stepping mode

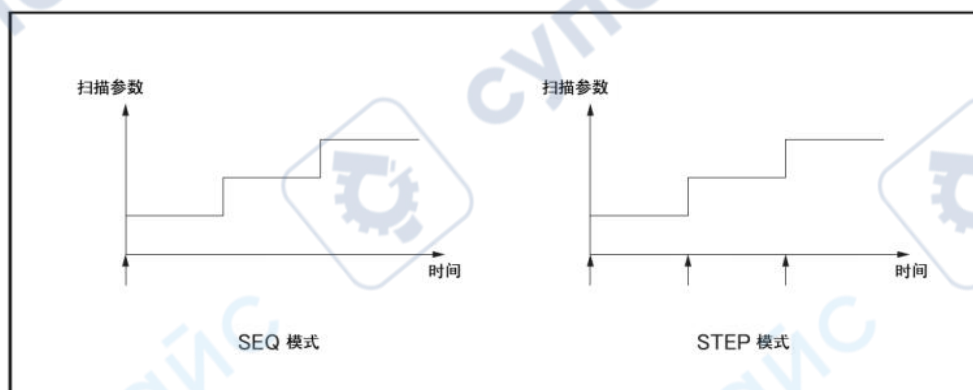

The steps of setting the List sweep mode:

1. Press the [Meas Setup] key.
2. Press the [List sweep] function key.
3. Use the arrow key to select "Sweep mode", press the [Enter] key.
4. Use the function key to select the Sweep mode.

Function keys:

Seq sets the List sweep to the sequential mode

Step sets the List sweep to the stepping mode

The page is shown below

Set the mode

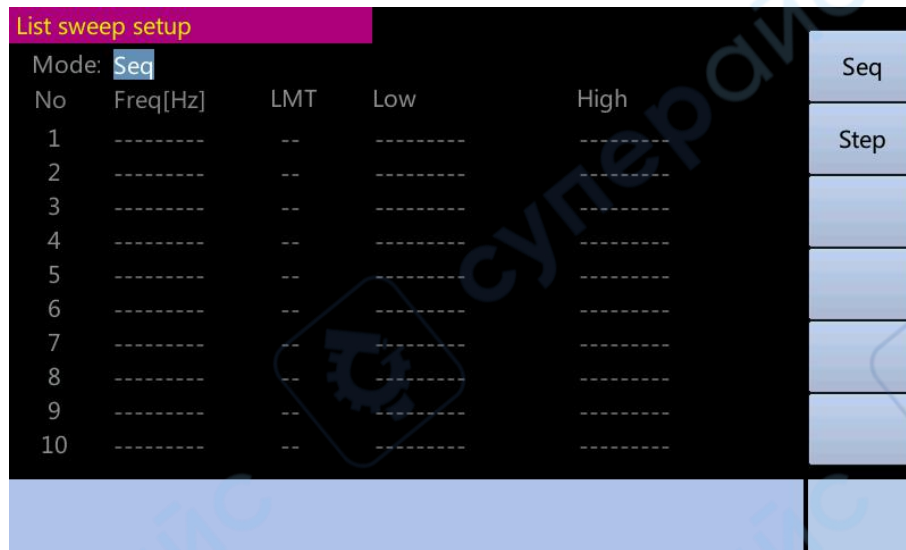

### 3.4.2 List Sweep Parameters

The sweep parameters in List sweep can be the frequency, signal level and DC bias.

The steps of setting the List sweep parameters:

1. Press the [Meas Setup] key.
2. Press the [List sweep] function key.
3. Use the arrow key to select the sweep parameters, and press the [Enter] key.
4. Use the function key to select the sweep parameters the users needs.

Function keys:

Frequency [Hz] use the frequency as the List sweep parameter

Level [V] use the voltage as the List sweep parameter

Level [I] use the current as the List sweep parameter

Bias [V] use the voltage of DC bias as the List sweep parameter

Bias [I] use the current of DC bias as the List sweep parameter

The page is shown below

Set the frequency

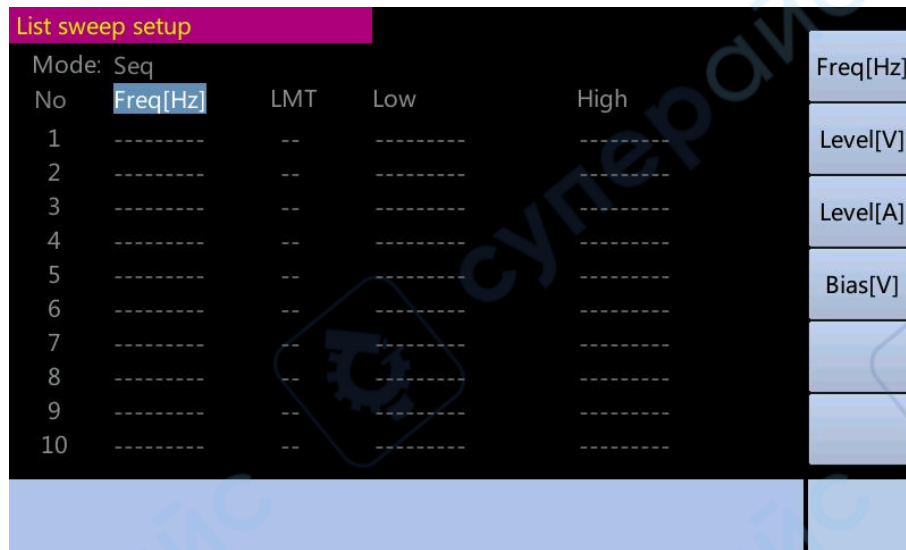

### 3.4.3 List upper limit/lower limit

The steps of setting the list upper limit/lower limit:

1. Press the [Meas Setup] key.
2. Press [List sweep] function key.
3. Use the arrow key to select "LMT".
4. Use the function key to select the parameter which needs comparison as required by the user (function keys: Parameters A, Parameter B and off).
5. Use the arrow key to select "lower limit".
6. Enter the lower limit.
7. Use the arrow key to select "upper limit".
8. Enter the upper limit.

Note: If the user only configures the lower limit of the sweep point, then the DUT with the selected main parameter or auxiliary parameter smaller than the lower limit is estimated to be "low". If the user only configures the upper limit of the sweep point, then the DUT with the selected main parameter or auxiliary parameter larger than the upper limit is estimated to be "high".

The page is shown below

Set the limit parameter

List sweep setup					
Mode: Seq					A
No	Freq[Hz]	LMT	Low	High	
1	1kHz	--	-----	-----	B
2	-----	--	-----	-----	--
3	-----	--	-----	-----	
4	-----	--	-----	-----	
5	-----	--	-----	-----	
6	-----	--	-----	-----	
7	-----	--	-----	-----	
8	-----	--	-----	-----	
9	-----	--	-----	-----	
10	-----	--	-----	-----	

Set the upper limit and lower limit

List sweep setup					
Mode: Seq					$\Omega$
No	Freq[Hz]	LMT	Low	High	
1	1kHz	A	-----	-----	n $\Omega$
2	-----	--	-----	-----	$\mu\Omega$
3	-----	--	-----	-----	m $\Omega$
4					k $\Omega$
5					M $\Omega$
6					
7	-----	--	-----	-----	
8	-----	--	-----	-----	
9	-----	--	-----	-----	
10	-----	--	-----	-----	

## IV. System configuration

### 4.1 System configuration display

Press the [System] key to open the system configuration page. It displays the system information of ET35.

System configuration display

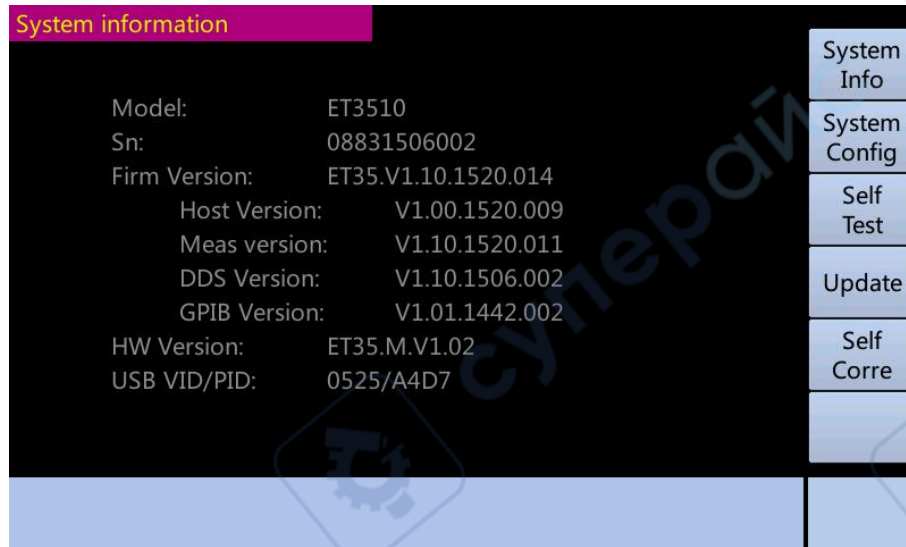

The page shows some system information of the instrument, such as "type", "SN", "firmware version", "firmware date" and "USB ID", and the information cannot be changed. Information on this page can be set as follows:

- bias current interface
- HANDLER interface

Note: If ET35 is not configured with bias current interface, the "bias current interface" shows the message "not installed" and the on / off setting is unavailable.

If ET35 is not configured with HANDLER interface, the "HANDLER interface" shows the message "not installed" and the On / Off setting is unavailable.

## 4.2 System configuration display

Press the [System] key and then press the [System Config] function key to open the system configuration page.

System configuration page

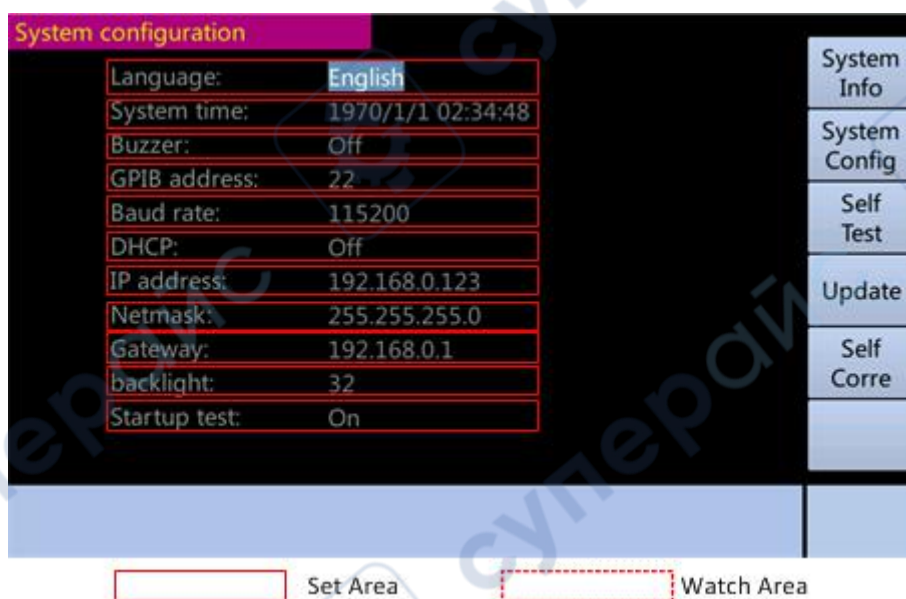

The system configuration page displays the status of LAN and GPIB interface; the user can place the cursor on the right field to configure the following controls.

- voice prompts
- system time
- GPIB address
- DHCP
- automatically obtain an IP address
- manually configure an IP address
- manually configure the subnet mask
- manually configure the gateway

Additionally, this page also displays the IP address, subnet mask and gateway by initiating “automatically obtain an IP address”

## 4.2.1 Language switching

ET35 support 2 languages—Chinese and English, and the page is shown below

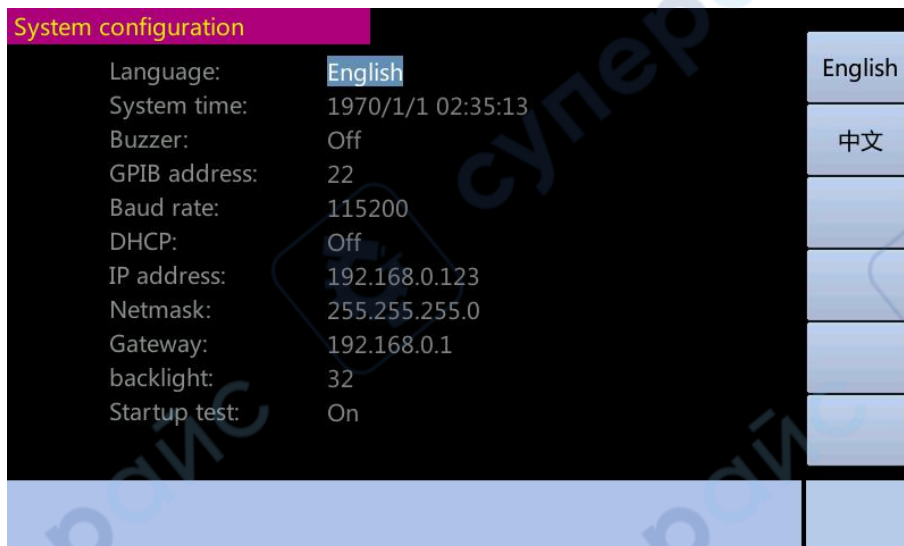

### 4.2.2 Configuring system time

ET35 has a built-in clock.

The steps of configuring the system time:

1. Press the [System] key.
2. Press the [System Config] function key.
3. Use the arrow key to select "System Time", and press the [Enter] key.
4. Use the [↑] and [↓] function keys to change the value as corresponding to the right time.
5. Use the [←] and [→] function keys to select the time entry you want to change, such as the "year", "month", "day", "hour", "minute" and "second."

The page is shown below

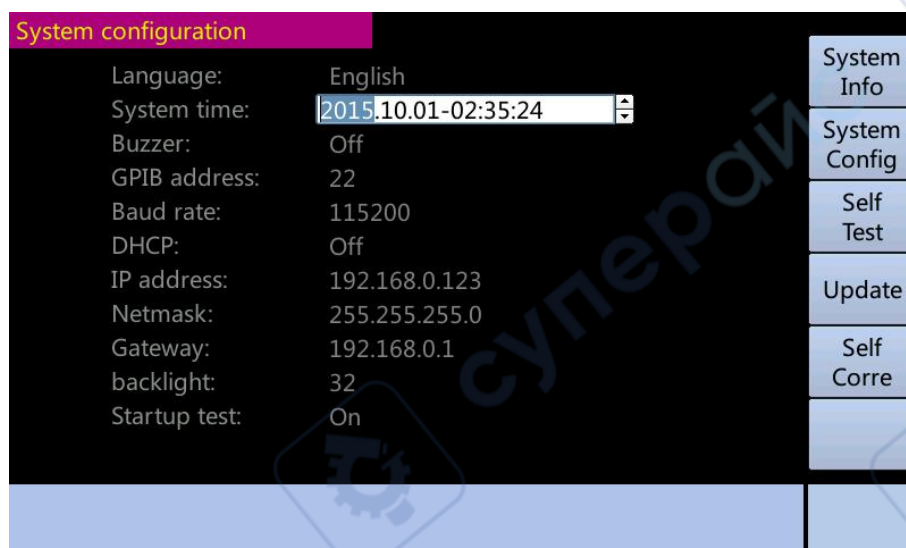

### 4.2.3 Turn on/off buzzer function

ET35 has the voice prompt function and will issue voice prompt in the event of one or more of the following situations:

- display wrong message or warning message
- the open / short circuit correction has been done for the instrument
- the open / short circuit / load correction has been done at the designated point by the user for the instrument
- the limit test for the DUT fails, or the comparator has been classified by the DUT into OUT OF BIN / AUX BIN
- DUT passes the limit test, or the comparator has been classified by the DUT into any one from BIN1 to BIN8

- enable/disable key locked

The steps of setting the voice prompt function

1. Press the [System] key
2. Press the [System Config] function key
3. Use the arrow key to select "Buzzer", and press the [Enter] key
4. Press the corresponding function key to activate or deactivate voice prompt

The page is shown below

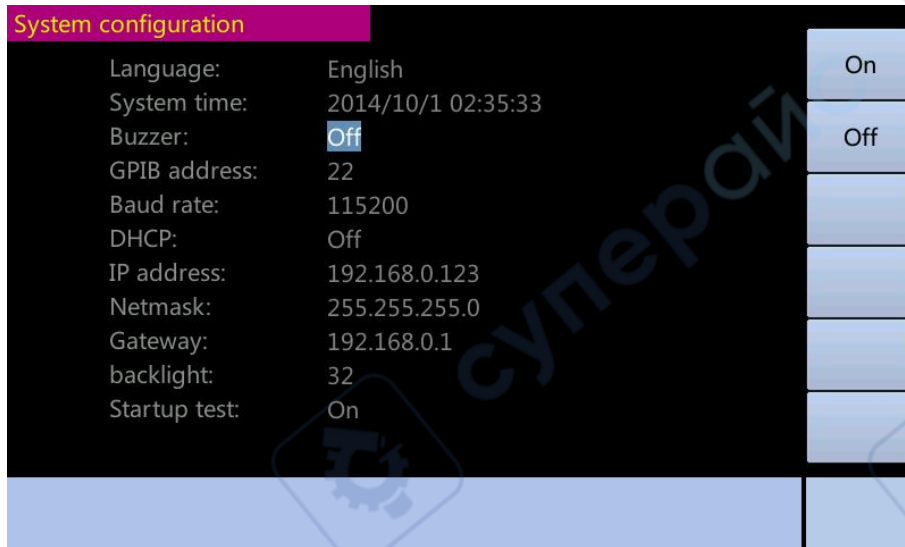

### 1.2.4. Configuring GPIB address

The GPIB address of ET35 must be configured before it is controlled by the GPIB command issued from the external controller connected to the GPIB connector of ET35.

The steps of configuring GPIB address:

1. Press the [System] key.
2. Press the [System Config] function key.
3. Use the arrow key to select "GPIB Address", and press the [Enter] key.
4. Use numeric keys to input the value within the range from 0 to 30.

The page is shown below

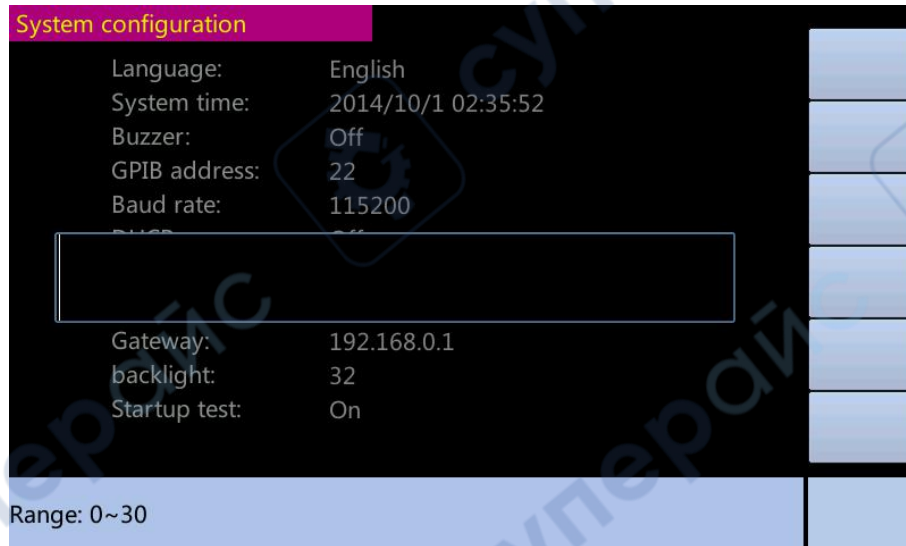

## 4.2.5 Configuring Baud rate

The Baud rate of ET35 must be configured before it is controlled by the SCPI command issued from the external controller connected to the RS232 connector of ET35.

The page is shown below

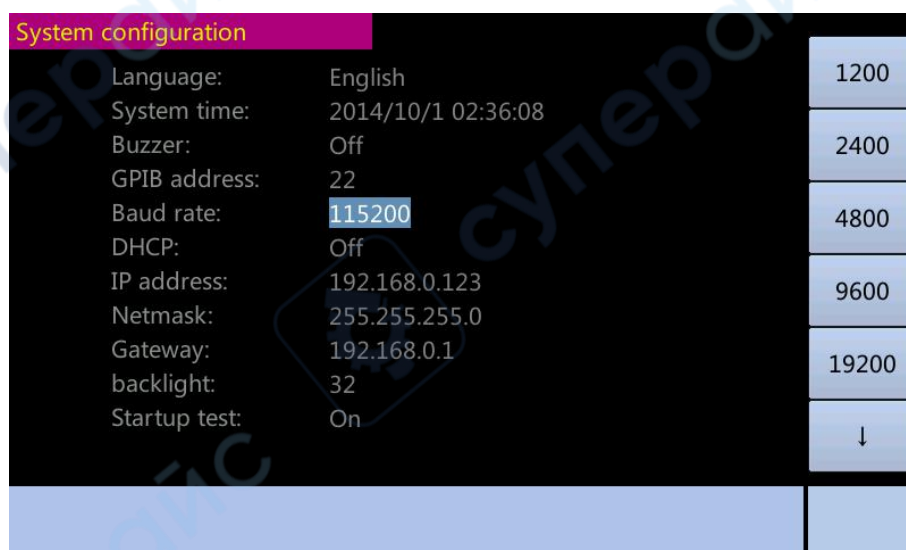

## 4.2.5 Configuring LAN IP address

To achieve the communication of ET35 through LAN, an IP address must be configured and LAN cable connected.

The IP address can be automatically obtained or manually configured.

Method of obtaining IP address

Method	Description
DHCP	Available IP address can be automatically obtained through DHCP server
IP address	IP address, subnet mask and gateway can be manually configured

After the IP address is automatically obtained, refresh the interface, and check the following areas in the system configuration page to view the address, subnet mask and gateway:

- IP address
- Subnet Mask
- Gateway

IP address depends on the following conditions

DHCP	Assigned IP address
On	Assigning DHCP address
Off	Assigning the IP address manually configured

The steps of obtaining an IP address automatically:

1. Press [System].
2. Press the [System Config] function key.
3. To get an IP address through DHCP, you can use the arrow key to select "DHCP", and press the [Enter] key.
4. Press the [On] function key.

The page is shown below

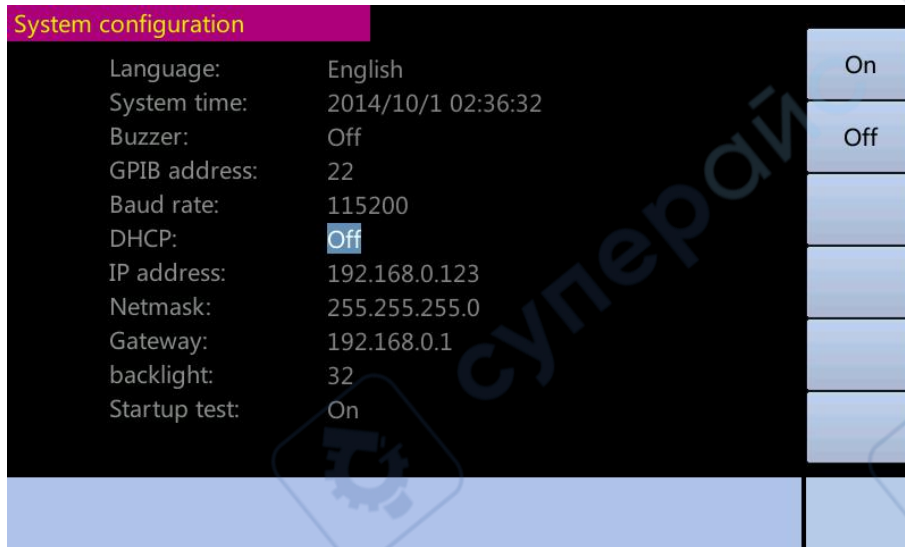

The steps of manually configuring the IP address:

1. Press [System].
2. Press the [System Config] function key.
3. Use the arrow key to select "DHCP", and press the [Enter] key.
4. Press the [Off] function key.
5. Use the arrow key to select "IP Address", and press the [Enter] key.
6. Use numeric keys to enter the IP address. For example: 192.168.10.1, and press the [Enter] key.
7. Use the arrow key to select "Subnet Mask" and press the [Enter] key.
8. Enter the subnet mask with numeric keys, press the [Enter] key.
9. Use the arrow key to select "Gateway", and press the [Enter] key.
10. Use numeric keys to enter the gateway, press the [Enter] key.

The page is shown below

Set IP

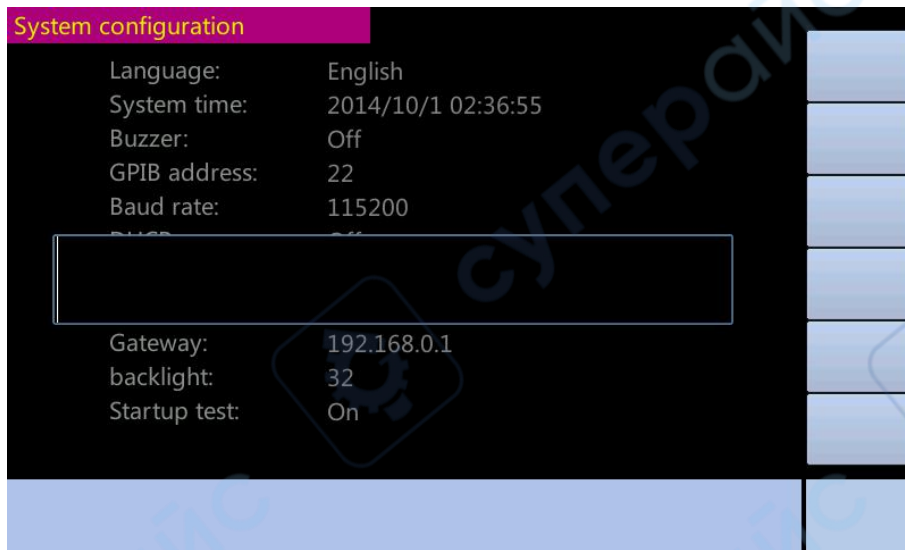

Set subnet mask

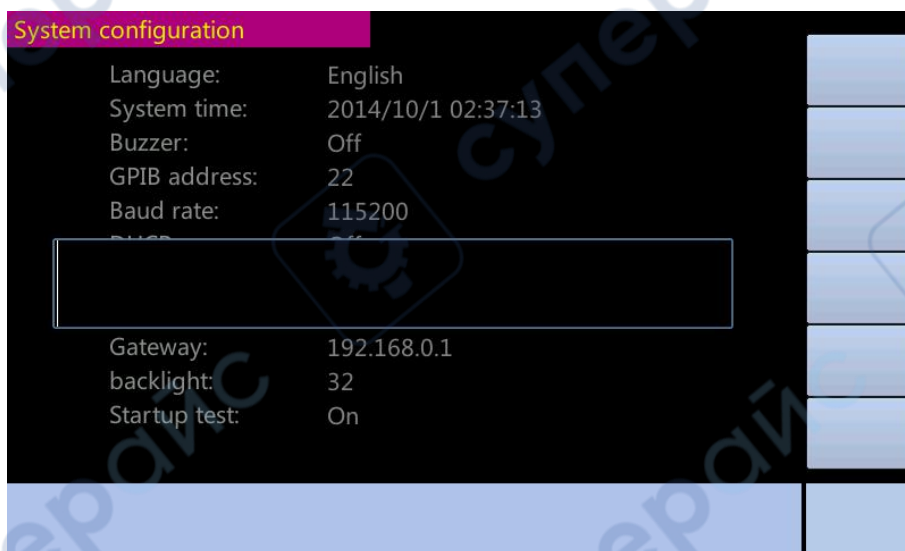

## Set gateway

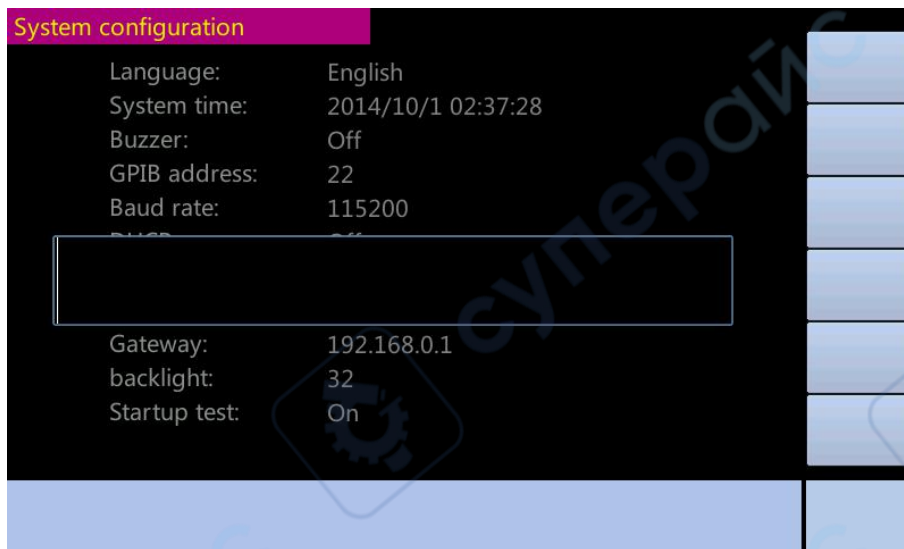

## 4.2.6 Setting the backlight

ET35 can set 32 grades of backlight: the greater the value is, the greater the intensity of the backlight is.

The steps of setting the backlight:

1 Press [System].

2 Press the [System Config] function key.

3 Use the arrow key to select "Backlight", and press the [Enter] key.

4 After using the arrow key to adjust the intensity of the backlight, press the Enter key to set the intensity of the backlight.

As shown below

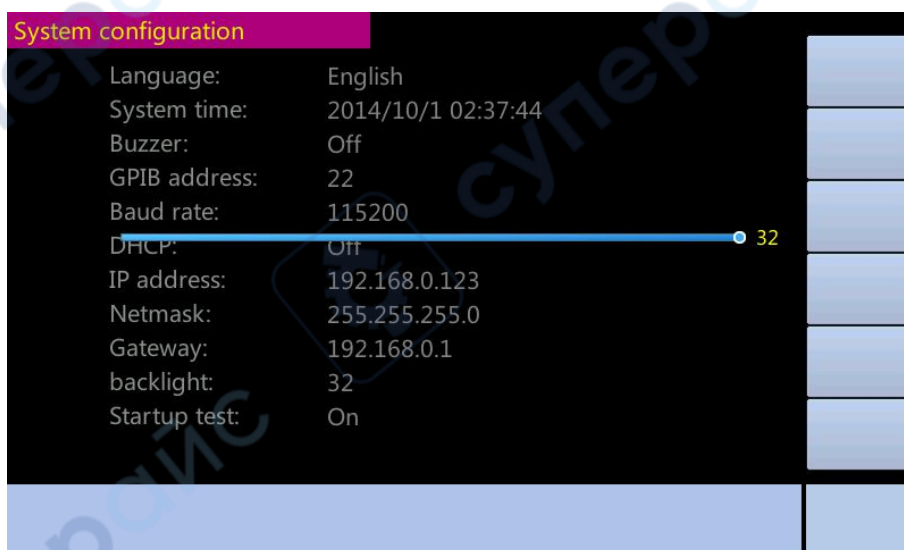

## 4.2.8 Startup test

ET35 allows the user to decide whether it is necessary to perform startup test after the power is on. STARTUP TEST can help detect failures of the equipment and help the user to find the problem.

The steps of setting STARTUP TEST:

- 1 Press [System].
- 2 Press the [System Config] function key.
- 3 Use the arrow key to select the "startup test", and press the [Enter] key.
- 4 Press [On] or [Off] function key to set startup test.

As shown below

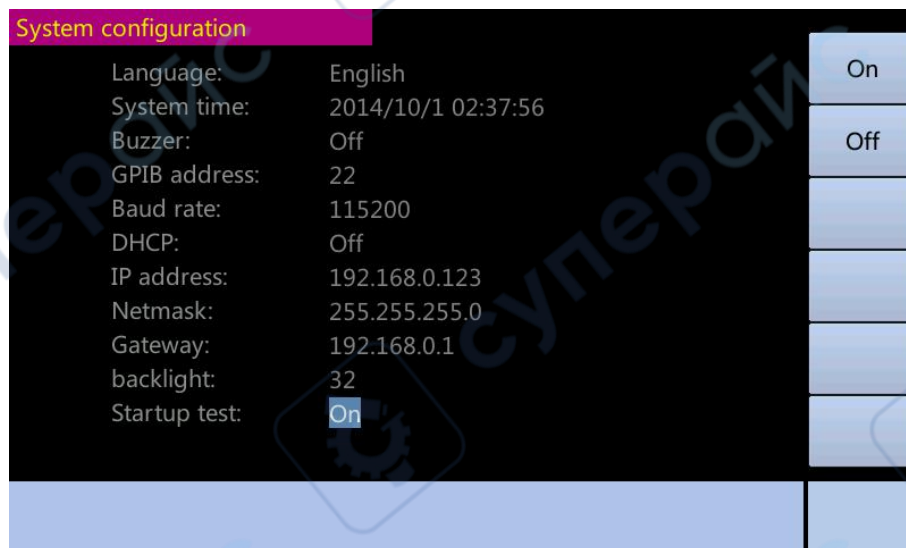

## 4.3 System self test

ET35 can conduct self test, so that in case of failure, it can discover the problems and the source of the problems with self test.

The page is shown below

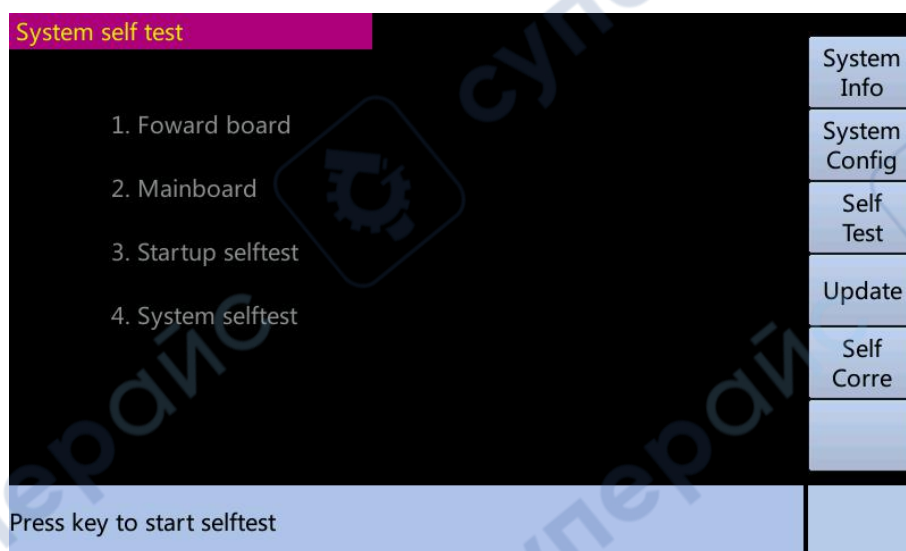

There are four kinds of self-test modes, which are front panel self-test, board self-test, startup test, and system self-test

Front panel self-test helps check the level of the crystal liquid display of the front panel, Ethernet, and GPIB.

Board self-test helps check if all the functions of the board are normal.

Startup test helps check if the key functions of the front panel and board are normal. If the startup test function is enabled in the system configuration page, then it will implement startup test when the power is on. It will return to the measurement display if all functions are normal.

System self-test helps check if all the functions of the front panel and board are normal.

The steps of self test:

1. Press [System] key.
2. Press the [System self test] function key to enter the system self-test display.
3. Press the corresponding number key to select the appropriate type of self-test.
4. The system then starts a self-test, and displays the current self-test content and results after which it will give the corresponding tips.
5. When the self-test ends, press [←] to return to the self-test display to re-select the self-test, or press [ESC] to cancel the self-test.

The self test is shown below

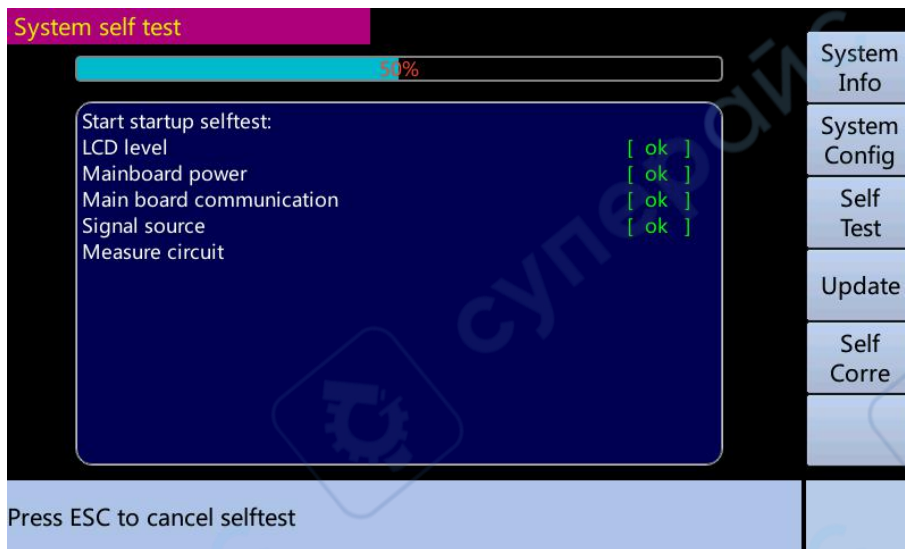

Self test completed

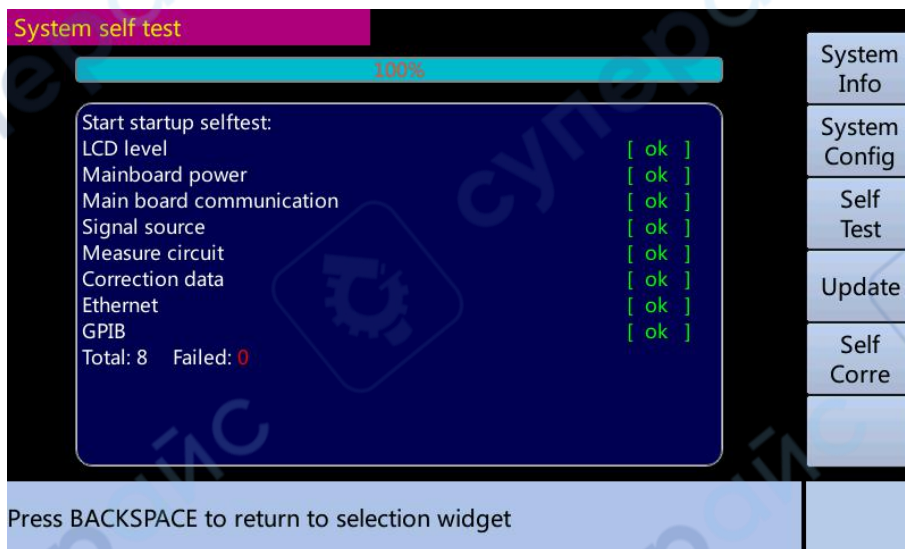

## 4.4 System update

ET35 supports system update. Update the module of the front panel, measurement motherboards, DDS, and GPIB to improve the capacity of the instrument.

The steps of system update

1. Put the system upgrade file ET35.Vx.xx.xxxx.xxx.upt into the file folder with the root directory /updatefile in the U-disc.
2. Insert U disk into the U disk interface of ET35
3. Press the [System] key
4. Press the [System update] to enter the system update page
5. Press the [Enter] key to start the update
6. After the update is completed, restart the instrument

As shown below

Updating starts

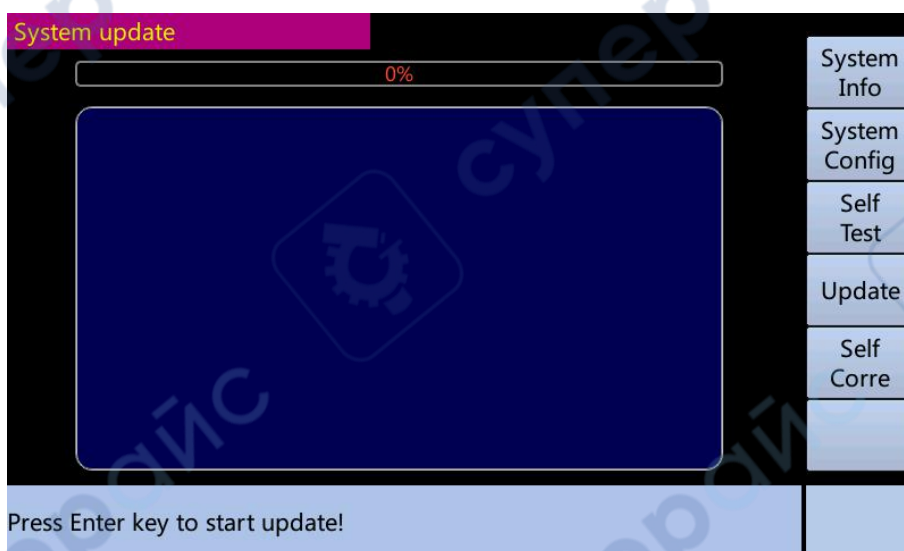

### Updating

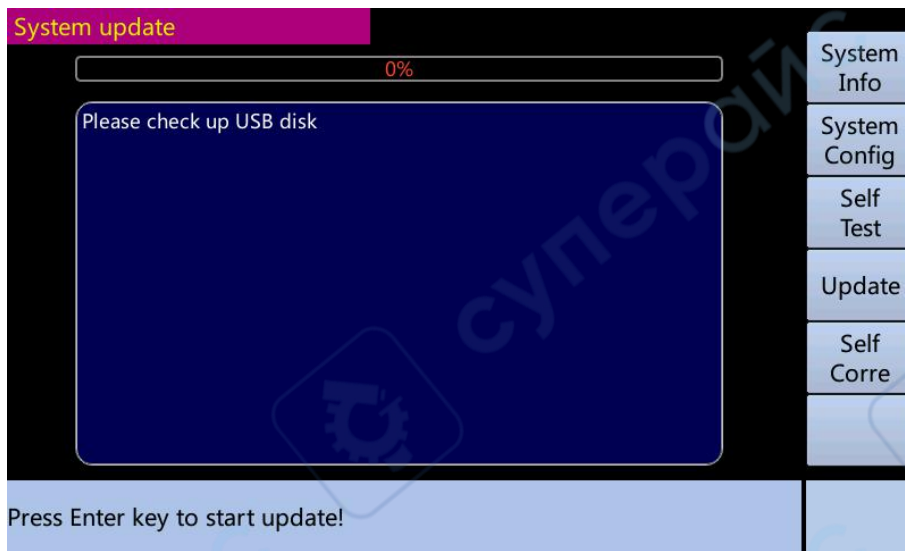

### Update completed

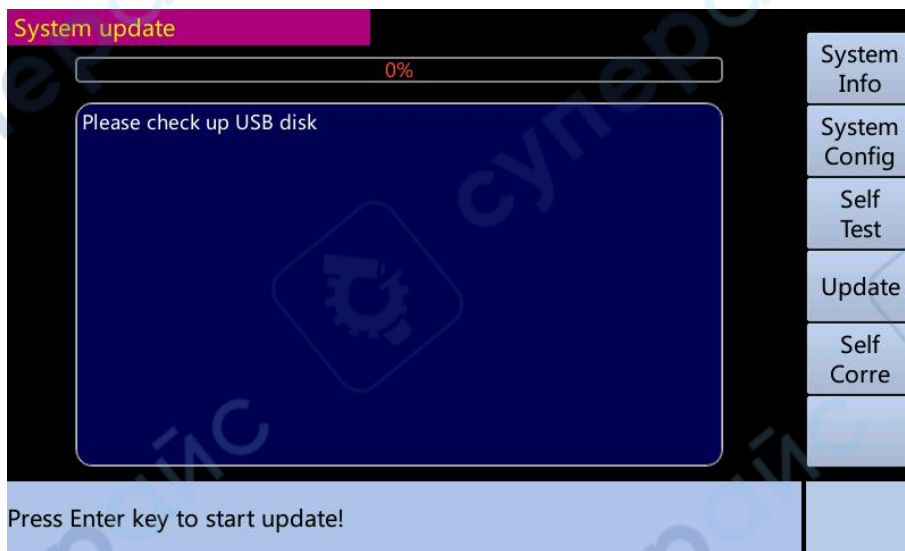

## 4.5 Self correction

ET35 supports Self correction. The measurement errors of the instrument are corrected with the Self correction function so as to enhance the accuracy of the instrument.

The steps of Self correction:

1. Press the [System] key.
2. Press the [Self corre] function key to enter the Self correction page.
3. Press the [Enter] key key to start the system self correction.

As shown below

Self correction starts

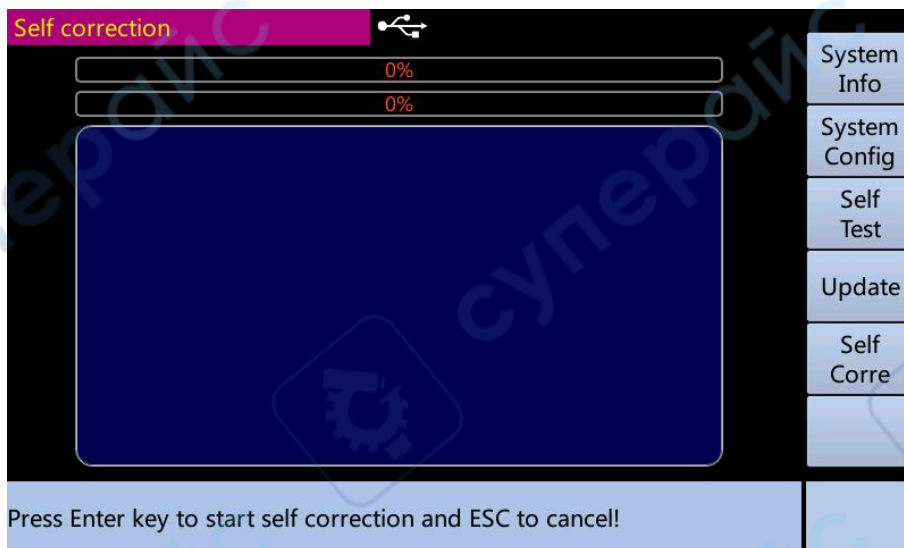

Self correcting

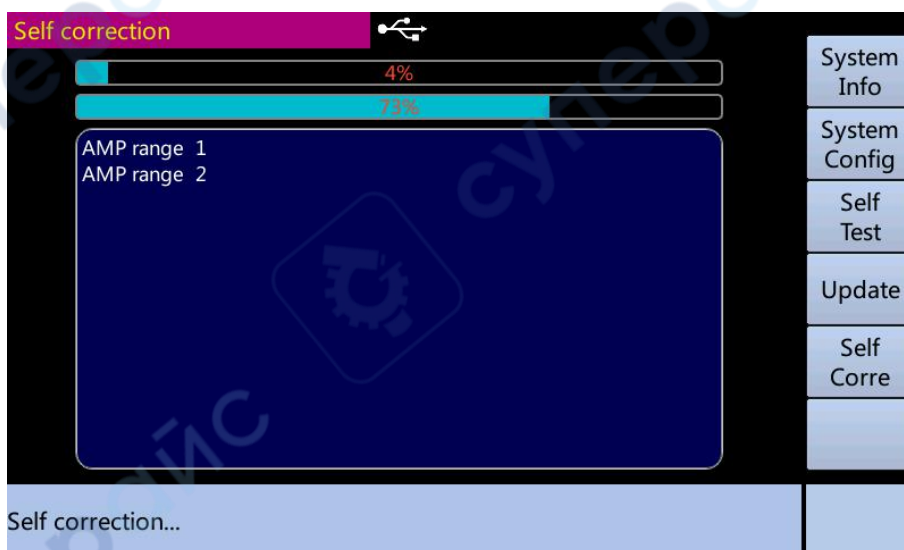

Self correction completed

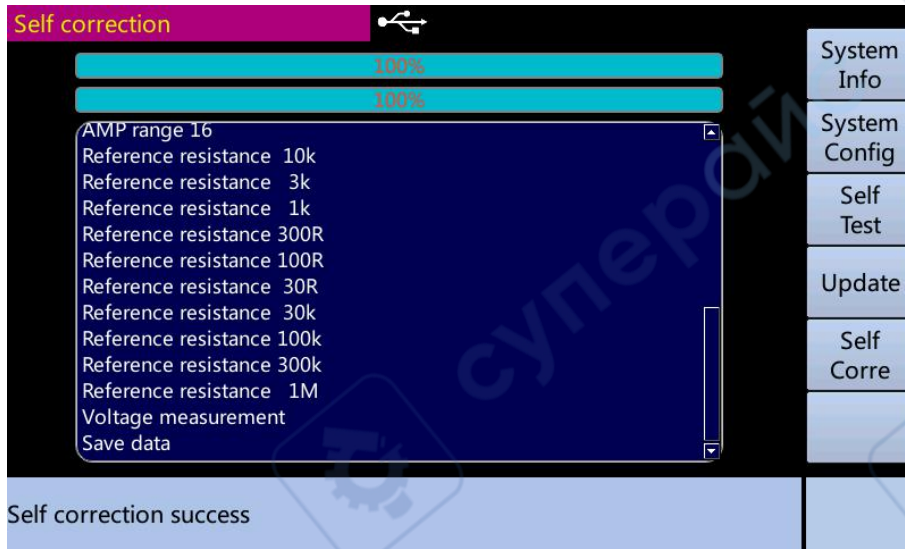

## V. Save / call

By the save / recall function, the user can not only save the configuration and measurement results to the internal memory of ET35 or external USB memory, but can recall them from the internal memory of ET35 or external USB memory.

Methods of saving and the purposes

Methods of saving		Callable	Purposes
Type	File format		
Configuring saved (internal memory)	.cfg	Yes	Save the configuration of ET35 to the internal memory
Configuring saved (USB memory)	.cfg	No	Save the configuration of ET35 to the USB memory
Data saved (USB memory)	CSV format (.csv)	No	Save the measurement results to the USB memory
Screen saved (USB memory)	GIFformat (.png)	No	Save the snapshot of the screen to the USB memory

File folder/ file structure on the USB memory

To save the information to the USB memory, the predefined plan will be used to organize the file folder and files on the memory

File folder	Maximum number of files	Description
data	999	Including the measurement result such as .csv files
pic	999	Including the snapshots of the screen such as .gif files
cfg	999	Including the configuration status of the instrument

Notes to USB Memory

The following matters should be paid attention to when ET35 is used with the USB memory:

- Use the USB memory with interface USB2.0
- Use the USB memory with mass storage capacity which complies with FAT16 or FAT32 standard, and format it with the FAT16 or FAT32 format standard
- Use ET35 dedicated USB memory. Otherwise, the data previously saved in USB memory may be erased
- If the file cannot be saved to or recalled from USB memory, other USB memories can be used

The save display is shown below

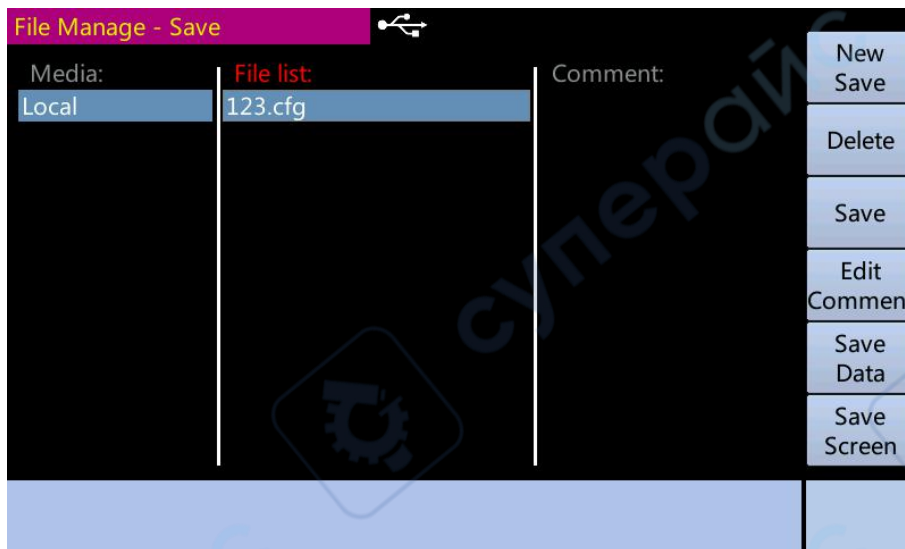

The recall display is shown below

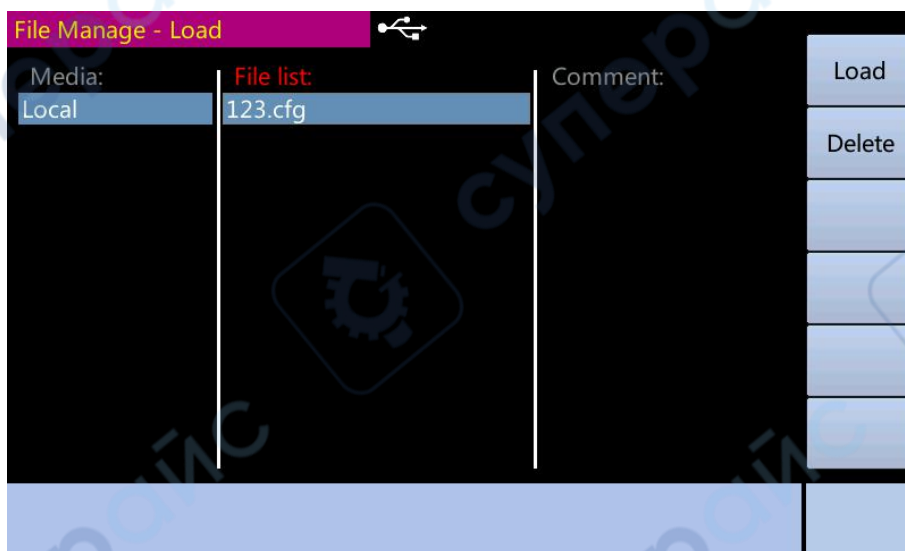

## Saving the configuration of the instrument to the internal memory

The steps of saving the configuration of the instrument to an existing file in the internal memory:

1. Press the [Save] key.
2. Press the up and down arrow keys to select the target file.
3. Press the [Save] function key to save or press [Edit] to edit comments, and then press the [Enter] key to save.
4. Prompt success.

The steps of saving the configuration to a new file in the internal memory:

1. Press the [Save] key.
2. Press the [New file] function key.
3. Enter the file name and press the [Enter] key to confirm the save.
4. Press the [Edit] to edit comments and then press the [Enter] key to confirm.
5. Prompt success.

## **Saving the configuration of the instrument to the USB memory**

The steps of saving the configuration of the instrument to an existing file on the USB memory:

1. Press the [Save] key.
2. Press [-] key to select the option to switch to the media (the word media will appear highlighted in red).
3. Press the down arrow to select USB media, and press [->] to return the file list option.
3. Press the up and down arrow keys to select the target file.
4. Press the [Enter] key to save or press [Edit] to edit the comment and press [Enter] to save.
5. Prompt success.

The steps of saving the configuration of the instrument to a new file on the USB memory

1. Press the [Save] key.
2. Press the [-] key to switch to the option of media (the media will be highlighted in red).
3. Press the down arrow to select USB media, and press [->] to return to the file list option.
4. Press the [New file] function key.
5. Enter the file name and press the Enter key to confirm the save.
6. Press [Edit] to edit the comment and press the [Enter] key to confirm.
7. Prompt success.

## **Loading the configuration file of the instrument from the internal memory**

The steps of loading the configuration file of the instrument from the internal memory:

1. Press the [Recall] key.
2. Select the up and down arrow keys to select the configuration files to be loaded.
3. Press the [Load] function key to load the configuration file.

4. Prompt success.

## **Loading the configuration file of the instrument from the USB memory**

The steps of loading the configuration file of the instrument from the USB memory:

1. Press the [Recall] key.
2. Press the [<-] key to switch to the option of media (the media will be highlighted in red).
3. Press the down arrow key to select USB media, and press [->] to return to the file list option.
4. Select the up and down arrow keys to select the configuration files to be loaded.
5. Press the [Load] function key to load the configuration file.
6. Prompt success.

## **Deleting the configuration file of the instrument from the internal memory**

The steps of deleting the configuration file of the instrument from the internal memory:

1. Press the [Save] or [Recall] key.
2. Select the profile to be deleted with the up and down arrow keys.
3. Press the [Delete] function key.
4. Prompt success.

## **Deleting the configuration file of the instrument from the USB memory**

The steps of deleting the configuration file of the instrument from the USB memory:

1. Press the [Save] or [Recall] key.
2. Press the [<-] key to switch to the option media (the media will be highlighted in red).
3. Press the down arrow key to select USB media, and press [->] to return to the file list option.
4. Select the profile to be deleted with the up and down arrow keys.
5. Press the [Delete] function key.
6. Prompt success.

## **Saving the measurement results on the USB memory**

Users can save the measurement result from ET35 as .CSV file to the USB memory. Then the users can download the saved files to the application programs on the computer.

Users can save up to 81,920 groups of measurement results at one time.

Before saving the measurement results to a USB memory, the user needs to do some preparation work to start the measurement, so that the data buffer contains the required data.

#### Format of measurement results

Data A and Data B in the measurement result file vary depending on whether the “valid digit” setting is on.

Comparator	Format of result
Off	<Data A>, <Data B>, <Status>
On	<Data A>, <Data B>, <Status>, <BIN No.>

<Data A> and <Data B> adopt the scientific notation with the precision of six digits after the decimal point

Status uses one of the following status values to represent the state of the measurement results:

0 Measurement completed successfully.

+1 Overload.

+3 Signal beyond the permitted limit of the signal source detected.

+4 Automatic level control functions fail.

0 OUT\_OF\_BINS

+1~+9 BIN 1~BIN 9

+10 AUX\_BIN

BIN No ( IN/OUT ) represents the bin classification result in the measurement as shown below:

0 OUT\_OF\_BINS

+1~+9 BIN 1~BIN 9

+10 AUX\_BIN

The steps of saving the measurement results on the USB memory:

1. Insert the USB memory into the front USB port.
2. Press the [Save] key.
3. Press the [Save Data] function key.
4. Press the [Start recording] function key to enter the result into the data buffer memory.
5. Start measurement.
6. Press the [Save and stop] function key to stop the recording and save the results to a USB memory.
7. Prompt success.

## **Saving the snapshots of the screen on the USB memory**

Users can save the snapshots of the screen from ET35 as .png file to the USB memory. Then the users can download the saved files to the application programs on the computer.

The steps of saving the snapshots of the screen on the USB memory:

1. Display the screen to be saved.
2. Insert the USB memory device into the front USB port.
3. Press the [Save] key.
4. Press the [Save Screen] function key.
5. Prompt success.

## VI. Technical indicators and performance test

### 6.1 Technical indicators

The difference between the technical indicators of all types of the ET35 series.

Model	ET3510	ET3505	ET3503	ET3502	ET3501
Test signal frequency range	10Hz-1MHz	10Hz-500kHz	10Hz-300kHz	10Hz-200kHz	10Hz-100kHz
Frequency resolution、accuracy	Resolution:1mHz, Accuracy:0.01%				
Test parameters	Cp-D, Cp-Q, Cp-G, Cp-Rp, Cs-D, Cs-Q, Cs-Rs, Lp-D, Lp-Q, Lp-G, Lp-Rp, Ls-D, Ls-Q, Ls-Rs, Rs-Xs, $ Z -\theta_r$ , $ Z -\theta_d$ , $ Y -\theta_r$ , $ Y -\theta_d$ , G-B				
Measuring display speed	Fast:50times/s (20ms), Medium:10times/s (100ms), Slow:1.25times/s (800ms)				
Custom measuring speed	Between 0.5times/s~200times/s, Can be set				
LCR parameter range	Cp、Cs: 0.001000pF~99.9999F Lp、Ls: 0.001000nH~99.9999kH Rp、Rs、 $ Z $ 、Xs: 0.001000m $\Omega$ ~999.999M $\Omega$ G、B、 $ Y $ : 0.001000 $\mu$ S~999.999kS $\theta_r$ : $\pm 0.000001\text{rad}$ ~ $3.14159\text{rad}$ $\theta_d$ : $\pm 0.000001\text{deg}$ ~ $179.9999\text{deg}$ D: $\pm 0.000001$ ~ $9.99999$ Q: $\pm 0.001$ ~ $99999.9$				
Test signal voltage range	0~2Vrms				
Voltage resolution、accuracy	Resolution:1mV, accuracy:5%+5mV				
Test signal current range	100 $\mu$ Arms~20mArms				
Current resolution、accuracy	Resolution:10 $\mu$ A, accuracy:5%+50 $\mu$ A				
DC bias voltage source	Internal: -2V~+2V voltage bias, -20mA~+20mA current bias External: -60V~+60V voltage bias				
Internal resistance of signal source	30 Ohm or 100 Ohm, selectable				
Basic accuracy	0.05%				
Display resolution	6 1/2 digit				

Comparator	9 groups of qualified setting, one group of unqualified setting, one group of auxiliary setting
Triggered mode	Internal, External, manual, bus
Mathematical operations	Delta (absolute value), Delta% (percentage), Direct reading
Calibration function	Self-calibration, open circuit, short circuit, load, 100 groups of customised frequency point
List scanning	10-point list scanning testing
Storage device	Internal/USB storage device
Interface	GPIB、LAN、RS232、USB Host、USB Device、Handler

## 6.1.1 Measurement function

ET35 series digital electrical bridge supports the following measurement functions:

Cp-D, Cp-Q, Cp-G, Cp-Rp,

Cs-D, Cs-Q, Cs-Rs,

Lp-D, Lp-Q, Lp-G, Lp-Rp,

Ls-D, Ls-Q, Ls-Rs,

Rs-Xs,

$|Z|-\theta_r$ ,  $|Z|-\theta_d$ ,

$|Y|-\theta_r$ ,  $|Y|-\theta_d$ ,

G-B.

## 6.1.2 Test signal

### (1) Test frequency

Test frequency	10Hz-1MHz(ET3510) 10Hz-500kHz(ET3505) 10Hz-300kHz(ET3503) 10Hz-200kHz(ET3502) 10Hz-100kHz(ET3501)
Resolution	1mHz
Accuracy	0.01%

### (2) Test level

Voltage

Rated value	Range	10mVrms~2Vrms
	Resolution	1mVrms

	Accuracy	$\pm(5\%+5\text{mVrms})$
Constant value	Range	10mVrms~1Vrms
	Resolution	1mVrms
	Accuracy	$\pm(2\%+2\text{mVrms})$

## Current

Rated value	Range	100 $\mu$ Arms~20mArms
	Resolution	10 $\mu$ Arms
	Accuracy	$\pm(5\%+50\mu\text{Arms})$
Constant value	Range	100 $\mu$ Arms~10mArms
	Resolution	10 $\mu$ Arms
	Accuracy	$\pm(2\%+20\mu\text{Arms})$

## (3) Bias voltage

Internal	Range	-2V~2V
	Resolution	1mV
	Accuracy	$\pm(2\%+5\text{mV})$
External	Range	-60V~60V
	Resolution	Depending on external input
	Accuracy	Depending on external input

## (4) Level monitoring

Level monitoring includes three items:

VAC: the actual voltage between both ends of the DUT

IAC: actual current through the DUT

EBIAS: external bias voltage applied (only displayed in the external bias mode)

VAC	Range	0.0001V~2.000V
	Resolution	Four digits and a half
	Accuracy	$\pm 5\%$
IAC	Range	0.0001nA~30.00mA
	Resolution	Four digits and a half
	Accuracy	$\pm 5\%$
EBIAS	Range	$\pm 0\text{V}\sim 60.00\text{V}$
	Resolution	0.01V

	Accuracy	$\pm (5\%+3V)$
--	----------	----------------

**(5) Output resistance**30 $\Omega$ , 100 $\Omega$  optional**6.1.3 Measurement time**

Fast, medium, slow, custom.

Slow: 800ms.

Medium: 100ms.

Fast: 20ms for ET3502, ET3503, ET3505, ET3510; 50ms for ET3501.

Custom: 5ms to 2s for ET3502, ET3503, ET3505, ET3510; 20ms to 2s for ET3501.

The measurement time must be an integer multiple of the measurement signal cycle, so the actual measurement time is related to the frequency of the measurement signal. The actual measurement time is calculated with the formula:

$$t_{real} = N.T$$

N is the number of the measurement signal cycles contained in the set measurement time (N is 1 when it is actually less than 1), T is a measurement signal cycle.

Mode of measurement time	Frequency					
	10Hz	100Hz	1kHz	10kHz	100kHz	1MHz
Slow	800ms	800ms	800ms	800ms	800ms	800ms
Medium	100ms	100ms	100ms	100ms	100ms	100ms
Fast	100ms	50ms	50ms	50ms	50ms	50ms
Fast*	100ms	20ms	20ms	20ms	20ms	20ms

Note: fast indicates the measurement time of ET3502, ET3503, ET3505, and ET3510; fast \* the measurement time of ET3501.

The actual custom measurement time of ET3502, ET3503, ET3505, and ET3510 is:

Frequency	10Hz	100Hz	1kHz	10kHz	100kHz	1MHz
Upper limit	2000ms	2000ms	2000ms	2000ms	2000ms	2000ms
Lower limit	100ms	10ms	5ms	5ms	5ms	5ms

The actual custom measurement time of ET3501 is:

Frequency	10Hz	100Hz	1kHz	10kHz	100kHz	1MHz
Upper limit	2000ms	2000ms	2000ms	2000ms	2000ms	2000ms

Lower limit	100ms	20ms	20ms	20ms	20ms	20ms
-------------	-------	------	------	------	------	------

### 6.1.4 Measurement display range

Parameter	Measurement display range
Cp, Cs	0.001000pF~99.9999F
Lp, Ls	0.001000nH~99.9999kH
Rp, Rs,  Z , Xs	0.001000mΩ~999.999MΩ
G, B,  Y	0.001000μS~999.999kS
θr	±0.000001rad~3.14159rad
θd	±0.000001deg~179.9999deg
D	±0.000001~9.99999
Q	±0.001~99999.9

## 6.1.5 Measurement accuracy

Measurement accuracy includes the errors in measurement stability, temperature coefficient, linearity, and repeatability measurement.

The test of measurement accuracy of the instrument shall be conducted under the following conditions:

- preheating time: ≥30 minutes.
- correctly conduct the clearing of open / short circuit correction after preheating
- DC bias is turned off.
- the instrument works within the range of "AUTO" to select the correct measurement range.

**Accuracy of |Z|, |Y|, L, C, R, X, G and B (the accuracy of L, C, X and B is applied when  $D_x \leq 0.1$ , and the accuracy of R and G is applied when  $Q_x \leq 0.1$ )**

The relative accuracy  $A_e$  is

$$A_e = \pm A_c + (A_b + 100 * K_z + K_l) * K_t[\%]$$

$A_c$  correction accuracy

$A_b$  basic accuracy

$K_z$  impedance scaling factor

$K_l$  cable length factor

$K_t$  temperature factor

### Accuracy of D

The accuracy of D— $D_e$  is

When  $D_x \leq 0.1$ :

$$D_e = \pm A_e / 100$$

$D_x$  D measured

$A_e$  the relative accuracy of |Z|, |Y|, L, C, R, X, G, and B

When  $D_x > 0.1$ : (1 +  $D_x$ ) multiplied by  $D_e$

### The accuracy of Q (when $Q * D_e < 1$ )

The accuracy of Q— $Q_e$  is:

$$Q_e = \pm \frac{Q_x^2 * D_e}{1 \pm Q_x * D_e}$$

$Q_x$  Q measured

$D_e$  relative accuracy of D

### Accuracy of $\theta$

The accuracy of  $\theta$ — $\theta_e$  is

$$\theta e = \pm \frac{180 * Ae}{100\pi} [\text{deg}]$$

Ae the relative accuracy of | Z |, | Y |, L, C, R, X, G, and B

**Accuracy of Rp (when Dx≤0.1)**

The accuracy of Rp—Rpe is:

$$Rpe = \pm \frac{Rpx * De}{Dx \mp De} [\Omega]$$

Rpe relative accuracy of Rp

Rpx Rp (Ω) measured

Dx D measured

De relative accuracy of D

**Accuracy of Rs (when Dx≤0.1)**

The accuracy of Rs—Rse is:

$$Rse = \pm Xx * De [\Omega]$$

$$Xx = 2\pi fLx$$

Rse relative accuracy of Rs

Dx D measured

Xx X (Ω) measured

De relative accuracy of D

f test frequency (Hz)

Cx C (F) measured

Lx L (H) measured

**Basic accuracy**

The basic accuracy of the instrument is 0.05; with the changes of the test frequency and impedance of DUT, the basic accuracy will decrease. The basic accuracy and scope of application are shown below.

**Fast**

Test frequency(Hz )	Range of impedance				
	Smaller than 1Ω	1Ω to 10Ω	10Ω to 100kΩ	100kΩ to 1MΩ	Larger than 1MΩ
10 to 30	0.6	0.3	0.3	0.4	1
30 to 10k	0.6	0.2	0.1	0.2	0.2
10k to 30k	1	0.2	0.1	0.3	1
30k to 100k	2	0.6	0.3	0.6	2

100k to 300k	4	1	0.4	2	3
--------------	---	---	-----	---	---

**Slow, medisum**

Test frequency (Hz)	Range of impedance				
	Smaller than 1Ω	1Ω to 10Ω	10Ω to 100kΩ	100kΩ to 1MΩ	Larger than 1MΩ
10 to 30	0.3	0.15	0.15	0.2	0.5
30 to 10k	0.3	0.1	0.05	0.1	0.3
10k to 100k	0.5	0.1	0.05	0.15	0.5
100k to 300k	1	0.3	0.15	0.3	1
300k to 1M	2	0.5	0.2	1	3

When the test level is smaller than 1.5V and larger than 0.5V, see the table above for the basic accuracy; in other circumstances, it must be multiplied by the level correction factor. See the figures below for the level correction factor.

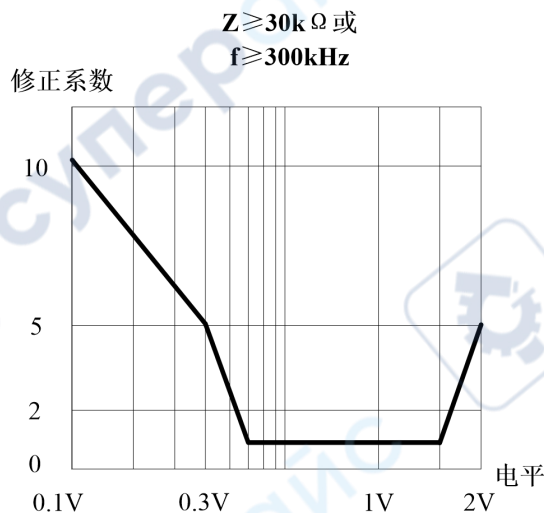
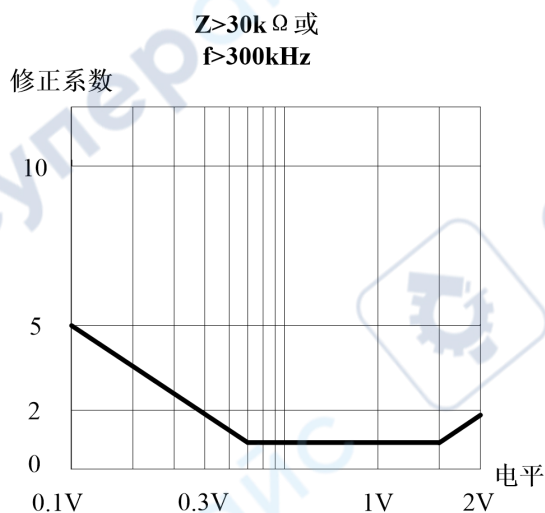

**Accuracy factor**

This section contains all accuracy correction factors: impedance scaling factor Kz, temperature factor Kc, correction factor Kf, cable length factor Kl.

Frequency/Hz	Kz (Zm < 500Ω)	Kz (Zm ≥ 500Ω)
Smaller than 100	$(\frac{1 \cdot 10^{-3}}{ Z_m })(1 + \frac{200}{V_s})(1 + \sqrt{\frac{100}{fm}})$	$ Z_m  (1 \cdot 10^{-9})(1 + \frac{70}{V_s})(1 + \sqrt{\frac{100}{fm}})$
100 To 100k	$(\frac{1 \cdot 10^{-3}}{ Z_m })(1 + \frac{200}{V_s})$	$ Z_m  (5 \cdot 10^{-9})(1 + \frac{70}{V_s})$

Larger than 100k	$\left(\frac{1 \cdot 10^{-3}}{ Z_m }\right) \left(2 + \frac{200}{V_s}\right)$	$ Z_m  (1 \cdot 10^{-8}) \left(1 + \frac{70}{V_s}\right)$
---------------------	---	---

Note:  $f_m$  in the table represents the test signal frequency (unit: Hz),  $Z_m$  is the impedance (unit:  $\Omega$ ),  $V_s$  is the test level (unit: mV)

#### Temperature factor $K_c$

$$K_c = 0.25 * (T - 20) \quad (\text{when } K_c < 1, K_c = 1)$$

T is the room temperature

#### Correction factor $K_f$

Measurement range	Frequency/Hz			
	10 to 100	100 to 100k	100k to 300k	300k to 1M
10k $\Omega$	0	0	0.01	0.01
3k $\Omega$ 、30k $\Omega$	0.01	0.00	0.02	0.02
1k $\Omega$ 、100k $\Omega$	0.02	0.01	0.03	0.03
300 $\Omega$ 、300k $\Omega$	0.03	0.02	0.04	0.04
30 $\Omega$ 、100 $\Omega$	0.04	0.03	0.05	0.05

#### Cable length factor $K_l$

0 meter	1 meter	2 meters	4 meters
$5 \cdot 10^{-4} * (1 + 0.05f_m)$	0	$5 \cdot 10^{-4} * (1 + 0.05f_m)$	$1 \cdot 10^{-3} * (1 + 0.05f_m)$

Note:  $f_m$  in the table is the test signal frequency (unit: kHz)

When the test level is 1V, the measurement accuracy using the Kelvin test fixture is as follows:

ET35 Series Digital Bridges (LCR) Operating Instructions

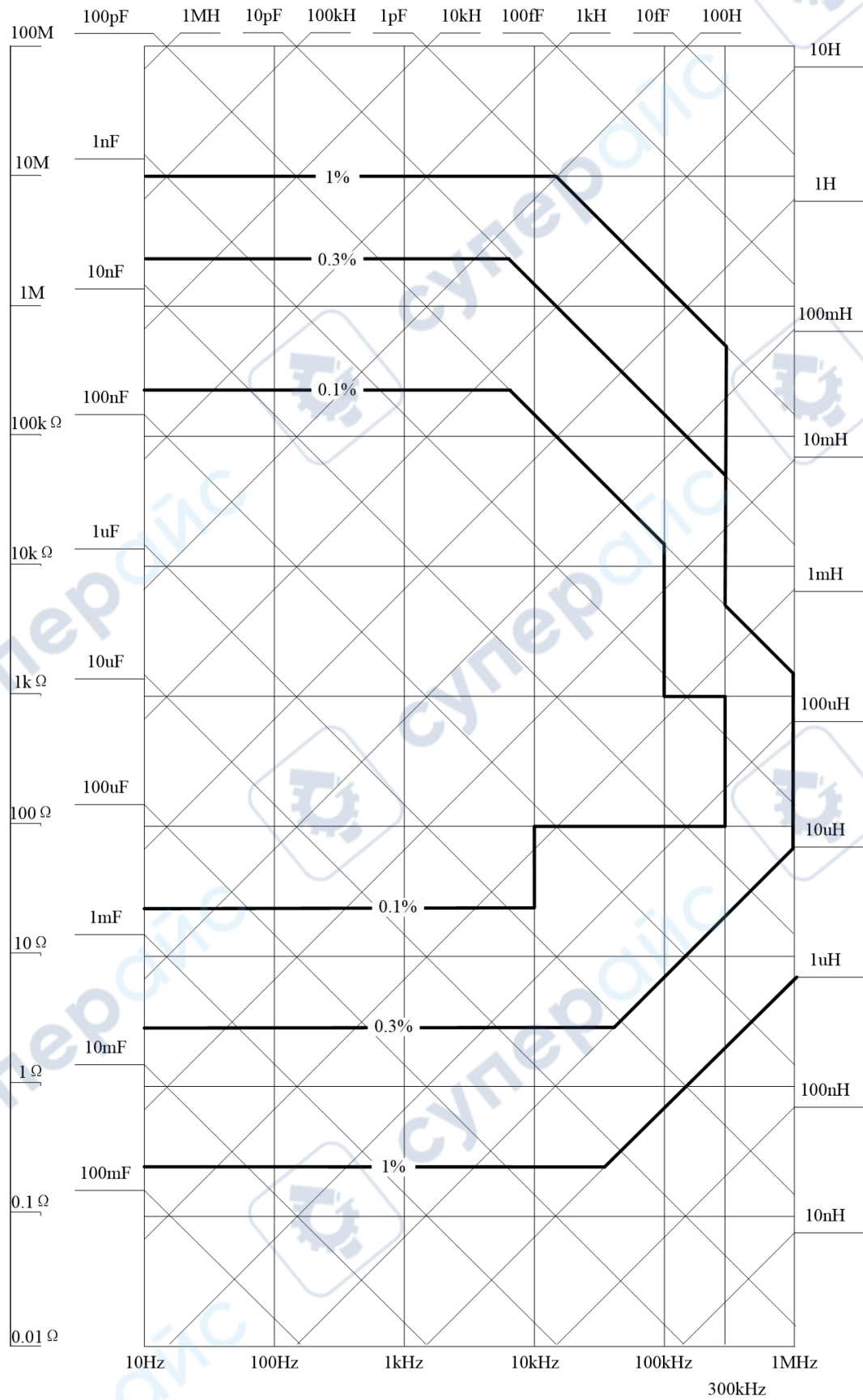

### 6.1.6 Correction function

ET35 Series digital bridge provides three types of correction: open circuit correction, short circuit correction and load correction.

Type of correction	Description
Open circuit correction	Compensate errors caused by stray admittance of the test fixture
Short circuit correction	Compensate errors caused by residual impedance of the test fixture
Load correction	Compensate errors between the actual measurement and standard value under the conditions required by the users

### 6.1.7 List sweep

#### (1) Points

A total of 100 sweep points

#### (2) Primary parameters

Test frequency, test voltage signal, test signal current, DC bias signal

#### (3) Triggering mode

Sequential mode

Once triggered, the device will be swept at all sweep points. /EOM/INDEX at the HANDLER interface will output for one time

Stepping mode

Once triggered, the device will be swept at the next point. /EOM/INDEX at the HANDLER interface will output for one time at each point, but the result from the List sweep comparator function will be provided after the last output of /EOM.

#### (4) List sweep comparator function

The comparator function allows the user to set a pair of lower and upper limits for each measurement point.

Users can make the following selections: determine through the first sweep parameter / not used for each limit.

### 6.1.8 Comparator function

#### (1) Bin classification

The primary parameter can be classified into 9 BIN, OUT\_OF\_BINS, and AUX\_BIN. The sequential mode or tolerance mode can be selected as the mode of classification.

## (2) Limit setup

You can set absolute value, deviation value and percentage deviation value.

## (3) Bin Count

From 0 to 999999.

## 6.1.9 Auxiliary function of measurement

### (1) Data buffering function

20k sets of measurement data

### (2) Save / Recall

The user can write 10 setting conditions into the built-in non-volatile memory, or read 10 setting conditions from the built-in non-volatile memory.

The user can write 10 setting conditions into the built-in USB memory, or read 10 setting conditions from the built-in USB memory.

The user can write the setting conditions into register 10 in the USB memory to implement the automatic recall function.

### (3) key lock function

Local mode can lock the keys on the front panel; press this key in the remote mode to exit the remote mode.

### (4) GPIB

24-pin D-Sub port (D-24 type), and the female connector is compatible with IEEE488.1,2 SCPI.

### (5) USB host port

Universal Serial Bus socket, A type (4 contact position, contact position 1 is on the left side of the user); the female connector is only connected to a USB storage device. The maximum current consumption is less than 200mA.

### (6) USB interface port

Universal Serial Bus socket, small sized B type (4 contact positions); consistent with USBTMC-USB488 and USB 2.0, and the female connector is used for connecting an external controller.

### (7) LAN

100BaseT Ethernet, 8 pins.

### (8) RS232C

DB9 female socket; Baud rate of the serial port (1200,2400,4800,9600,19200,38400,57600,115200) can be set; 8 data bits, 1 stopping bit, no parity bit.

## 6.2 Components

### 6.2.1 Standard accessories

- Three-core power cord
- 4-terminals of kelvin testing cable
- Lead-type kelvin testing fixture( only ET3510, 3505, 3503, three types is standard)
- Gilded short circuit bar

### 6.2.2 Optional accessories

- GPIB cable
- RS232 serial port line
- USB cable
- 2m/4m test cable
- SMD components t testing fixture
- LCR testing pen/4-lines SMT components testing fixture
- Kelvin testing fixture

## 6.3 General technical requirements

### 6.3.1 Power supply

- Voltage: 220V.AC $\pm$ 10%,OR 110V.AC (optional)
- Power frequency: 45Hz ~ 55Hz
- Power consumption:  $\cong$  20W

### 6.3.2 Operating environment

- Temperature: 0°C ~ 40°C
- Humidity: 15-85%
- Altitude: 0 m to 2k meters

### 6.3.3 Storage environment

- Temperature: 0°C ~ 40°C

- Humidity: 15-85%
- Altitude: 0 m to 2k meters

### 6.3.4 External dimensions

- 330mm\*285mm\*136mm (L \* W \* H)

### 6.3.5 Display

- 7 inch TFT LCD screen with a resolution of 800 \* 480

## 6.4 Performance test

The following content describes the test method of the technical specifications in this section.

### 6.4.1 Test conditions

- maintaining the temperature to  $20 \pm 2^{\circ}\text{C}$
- maintaining the humidity to  $50 \pm 20\%$
- preheat the instrument for 30 minutes before testing

### 6.4.2 Test tools

No.		Notes
1	Standard resistor (10 $\Omega$ , 100 $\Omega$ , 1k $\Omega$ , 10k $\Omega$ , 100k $\Omega$ )	Accuracy $\leq 0.02\%$
2	Standard capacitor (100pF, 1000pF, 0.01 $\mu\text{F}$ , 0.1 $\mu\text{F}$ , 1 $\mu\text{F}$ )	Accuracy $\leq 0.02\%$
3	Standard inductor (0.1mH, 1mH, 0.01H, 0.1H, 1H)	Accuracy $\leq 0.02\%$
4	Leaded measurement fixture with cable	ET35 standard configuration
5	6½-digit multimeter	With frequency meter

### 6.4.3 Test items

Frequency accuracy

Level output, measurement accuracy

Internal bias voltage accuracy

Resistance measuring accuracy

Capacitance measuring accuracy

Inductance measurement accuracy

## 6.4.4 Steps of measurement

### Frequency accuracy

Test point: 10Hz, 100Hz, 1kHz, 10kHz, 50kHz

1. Mount the test fixture on the output port of ET35, clamp the two probes of the multimeter with its two clips;
2. The six and a half digits are set to FRENQ mode;
3. Operating ET35: the output voltage is 1V, internal bias, the bias voltage is 0V, internal trigger, and slow speed;
4. According to the requirements for test point, set the **frequency** options, observe the six and a half digit measurement results, and record them in the column of **measurement results**;
5. Repeat step 4 until the test on all points is completed;
6. Compare to see if the actual accuracy meets the requirement.

### Level output, measurement accuracy

Test point: 10mV, 50mV, 100mV, 500mV, 1V

1. Mount the test fixture on the output port of ET35, clamp the two probes of the multimeter with its two clips;
  2. The six and a half digits are set to ACV mode;
  3. Operating ET35: the frequency is 1kHz, internal bias, the bias voltage is 0V, internal trigger, and slow speed;
  4. According to the requirements for test point, set the **level** options, observe the display of the multimeter and the VAC at the lower part of the screen of ET35 and record then in **measurement results and display results**;
- Repeat step 4 until the test on all points is completed;
5. Compare to see if the actual accuracy meets the requirement.

### Internal bias voltage accuracy

Test point: 0V, 0.5V, -0.5V, 2V, -2V

1. Mount the test fixture on the output port of ET35, clamp the two probes of the multimeter with its two clips;
2. The six and a half digits are set to DCV mode;
3. Operating ET35: the frequency is 100Hz, the level 10mV, the range 30Ω, internal bias, internal trigger, and slow speed;
4. According to the requirements for test point, set the **bias voltage** options, observe the the display of the multimeter, and record them in the column of **measurement results**;

5. Repeat step 4 until the test on all points is completed;
6. Compare to see if the actual accuracy meets the requirement.

#### **Resistance accuracy measurement**

Test point: 10 $\Omega$ , 100 $\Omega$ , 1k $\Omega$ , 10k $\Omega$ , 100k $\Omega$

Measuring frequency: 1kHz

1. Mount the test fixture on the output port of ET35;
2. Conduct the open circuit and short circuit corrections before the measurement;
3. Operating ET35: the level is 1V, internal bias, the bias voltage is 0V, internal trigger, slow speed, automatic range, and the function Rs-Xs;
4. According to the requirements for test point, connect the corresponding resistor;
5. Adjust the frequency and measure the data recorded;
6. Repeat step 4 and 5 until the test is completed;
7. Compare to see if the actual accuracy meets the requirement.

#### **Capacitance accuracy measurement**

Test point: 100pF, 1000pF, 0.01 $\mu$ F, 0.1 $\mu$ F, 1 $\mu$ F

Test frequency: 100Hz, 1kHz, 10kHz, 100kHz

1. Mount the test fixture on the output port of ET35;
2. Conduct the open circuit and short circuit corrections before the measurement;
3. Operating ET35: the frequency is 1kHz, the level 1V, internal bias, the bias voltage is 0V, internal trigger, slow speed, automatic range, and the function Cp-D;
4. According to the requirements for test point, connect the corresponding capacitor;
5. Adjust the frequency and measure the data recorded;
6. Repeat step 4 and 5 until the test is completed;
7. Compare to see if the actual accuracy meets the requirement.

#### **Inductance measurement accuracy**

Test point: 0.1mH, 1mH, 0.01H, 0.1H, 1H

Test frequency: 100Hz, 1kHz, 10kHz, 100kHz

1. Mount the test fixture on the output port of ET35;
2. Conduct the open circuit and short circuit corrections before the measurement;
3. Operating ET35: the frequency is 1kHz, the level 1V, internal bias, the bias voltage is 0V, internal trigger, slow speed, automatic range, and the function Ls-Q;
4. According to the requirements for test point, connect the corresponding inductor;
5. Adjust the frequency and measure the data recorded;
6. Repeat step 4 and 5 until the test is completed;
7. Compare to see if the actual accuracy meets the requirement.

## VII. Instruction on the use of Handler interface

ET35 digital bridge provides the user with Handler interface, which is mainly used for the output of the sorting of the instrument. When the instrument is used in an automatic component test system, the interface provides the signal to the system and the output of the sorting results. Sorting results corresponds to the output of the comparator 10. The design of Handler interface is flexible, and the states of all output signals are defined according to the requirements for use after the use of different operating procedures.

### Technical Description

The following table shows the technical description of Handler interface of ET35

---

Output signal: negative effective, open collector output, optoelectronic isolation

Level comparison function: Qualified level, tolerance level, and failed level

List sweep comparison function: IN / OUT at each sweep point and pass / fail of the comparison results

INDEX: simulation measurement completed

EOM: primary measurement completed

Alarm: momentary power failure detection notification

Input signal: optoelectronic isolation

Keylock: front panel keypad locked

External trigger: pulse width  $\geq 1\mu\text{S}$

Instructions

Definition of signal line

HANDLER interface uses three signals: comparison output, control output and control input. The signal lines of the level comparison function and List sweep comparison function are respectively defined as different comparison output signal and control input signal. The definition of the signals of the HANDLER interface is as follows when level comparison function or List sweep comparison function is applied.

### Signal line of comparison function

The signal line of comparison function is defined as follows:

- Comparison output signal: / BIN1 - / BIN9, / AUX, / OUT, / PHI (primary parameter is too high), / PLO (the main parameter is too low), / SREJ (auxiliary parameter fails).
- Control output signals: / INDEX (simulation measurement completion signal), / EOM (compare data valid signal after the end of measurement), / ALARM (power failure signal of the instrument).
- Control input signal:

/EXT.TRIG (External trigger signal) and / Keylock (keylock).

PIN No.	Signal name	Description
1	/BIN1	Level classification result: so /BIN output is open collector output
2	/BIN2	
3	/BIN3	
4	/BIN4	
5	/BIN5	
6	/BIN6	
7	/BIN7	
8	/BIN8	
9	/BIN9	
10	/OUT	
11	/AUX	
12	/EXT.TRIG	External trigger: when the triggering mode is set to EXT.TRIG (external trigger), ET35 is triggered by the rising edge pulse signal imposed on the pin.
13		
14	/EXT.DCV2	External DC voltage 2: DC supply pin of the photocoupling signal in the instrument (/EXT.TRIG, /KeyLock, /ALARM, /INDEX, /EOM)
15		
16	NC	No connection
17		
18		
19	/PHI	Main parameter is too high: the measurement results are larger than the upper limits of BIN1 to BIN9.
20	/PLO	Main parameter is too low: the measurement results are smaller than the lower limits of BIN1 to BIN9.
21	/SREJ	Auxiliary parameter fails: the measurement results are not within the limits for auxiliary parameter.
22	NC	No connection
23		
24		
26		

25	/KEY LOCK	When the line is valid, all function keys on the front panel of ET35 are locked and do not work.
27	EXT.DCV1	External DC voltage 1: DC supply pin of the photocoupling signal in the instrument (/EXT.TRIG, /KeyLock, /ALARM, /INDEX, /EOM) .
28		
29	/ALARM	When the power failure occurs, /ALARM is valid.
30	/INDEX	When the simulation measurement is completed and the test end of ET35 can be connected to the next DUT, /INDEX signal is valid. But the comparison results are valid only when /EOM is valid.
31	/EOM	After the measurement ends: the signal is valid when the measurement data and comparison results are valid.
32 33	COM2	Reference ground used by the external power supply EXTV2
34 35 36	COM1	Reference ground used by the external power supply EXTV1

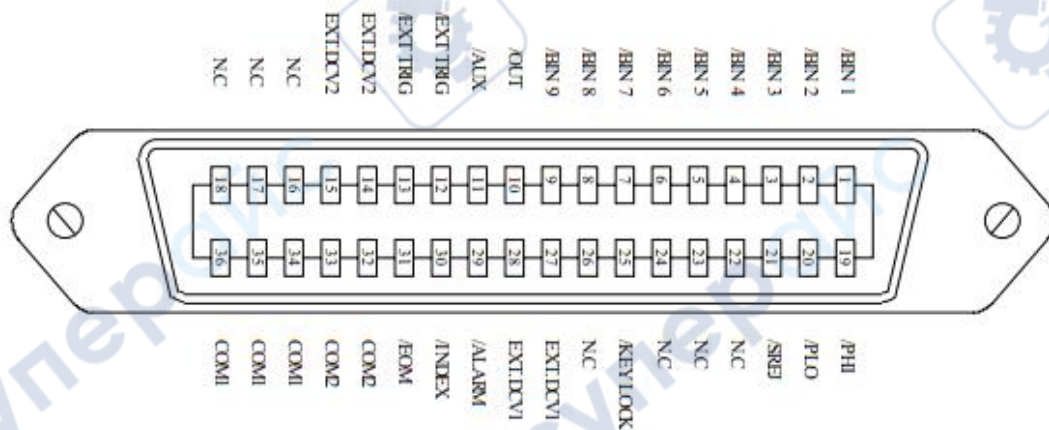

**Definition of Handler interface pins**

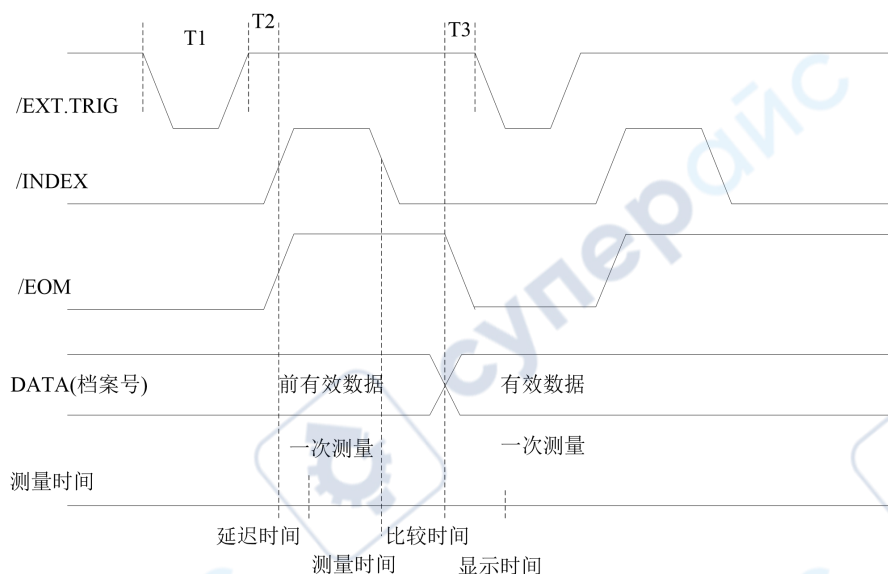

Sequence chart

Time	Minimum value	Maximum value
T1 trigger pulse	1uS	---
T2 delay time from the start of measurement	200uS	Display time <sup>3</sup> +200uS
T3 /EOM trigger latency time after output	0uS	---

Refer to the operating instruction on ET35 for measurement time

The typical comparison time is about 1ms

**Definition of the signal line of the List sweep comparator**

The definition of the List sweep comparison function signal differs from that of the level comparison function. It is defined as follows:

- Comparison output signal

/BIN 1 - /BIN 9 and /AUX respectively represents the IN/OUT test results from sweep point 1 to 10. /OUT represents whether the DUT test approves qualified / unqualified. The signals are output after the sweep cycle ends.

- Control signal

The output of /INDEX (simulation measurement ends) and /EOM (measurement cycle ends) signal differs as the Sweep mode of List sweep changes.

1. Sequential Sweep mode

/INDEX is output after the last simulation measurement of the sweep cycle is completed. When the sweep cycle is completed and all test results of the comparator are available, /EOM is output.

2. Stepping mode

/INDEX is output after the simulation measurement stepping in each sweep cycle is

completed. /EOM is output after all measurements end for each stepping in the sweep cycle.

#### Layout of List sweep comparator pins

PIN No.	Signal name	Description
1	/BIN1	Sweep point 1 exceeds the limit
2	/BIN2	Sweep point 2 exceeds the limit
3	/BIN3	Sweep point 3 exceeds the limit
4	/BIN4	Sweep point 4 exceeds the limit
5	/BIN5	Sweep point 5 exceeds the limit
6	/BIN6	Sweep point 6 exceeds the limit
7	/BIN7	Sweep point 7 exceeds the limit
8	/BIN8	Sweep point 8 exceeds the limit
9	/BIN9	Sweep point 9 exceeds the limit
10	/OUT	any sweep point exceeds the limit
11	/AUX	Sweep point 10 exceeds the limit
12	/EXT.TRIG	External trigger: when the triggering mode is set to EXT.TRIG (external trigger), ET35 is triggered by the rising edge pulse signal imposed on the pin.
13		
14	/EXT.DCV2	External DC voltage 2: DC supply pin of the photocoupling signal in the instrument (/EXT.TRIG, /KeyLock, /ALARM, /INDEX, /EOM)
15		
16	NC	No connection
17		
18		
19	/PHI	Main parameter is too high: the measurement results are larger than the upper limits of BIN1 to BIN9.
20	/PLO	Main parameter is too low: the measurement results are smaller than the lower limits of BIN1 to BIN9.
21	/SREJ	Auxiliary parameter fails: the measurement results are not within the limits for auxiliary parameter.
22	NC	No connection
23	NC	
24	NC	

26	NC	
25	/KEY LOCK	When the line is valid, all function keys on the front panel of ET35 are locked and do not work.
27	EXT.DCV1	External DC voltage 1: DC supply pin of the photocoupling signal in the instrument (/EXT.TRIG, /KeyLock, /ALARM, /INDEX, /EOM)
28		
29	/ALARM	When the power failure occurs, /ALARM is valid.
30	/INDEX	When the simulation measurement is completed and the test end of ET35 can be connected to the next DUT, /INDEX signal is valid. But the comparison results are valid only when /EOM is valid.
31	/EOM	After the measurement ends: the signal is valid when the measurement data and comparison results are valid.
32 33	COM2	Reference ground used by the external power supply EXTV2
34 35 36	COM1	Reference ground used by the external power supply EXTV1

#### Electrical characteristics

DC isolation output: Each DC output (pin 1 to 16) is isolated by the open collector optocoupler output. The output voltage of each line is set by the pull-up resistance on the HANDLER interface plate. The pull-up resistance is connected to the internal supplied voltage (+5V) or to the external supply voltage (EXTV: +5V) with the jumper.



Electrical characteristics of DC isolation output

Output signal	Rated output voltage		Maximum current	reference ground
	LOW	HIGH		
Comparison signal				internal pull-up voltage:
/BIN1 - /BIN9				ET35-ground
/AUX				
/OUT	$\cong 0.5V$	+5V~+24V	6mA	external voltage:
/PHI				COM1
/PLO				
Control signal				internal pull-up voltage:
/INDEX				ET35-ground
/EOM	$\cong 0.5V$	+5V -- +24V	5mA	external voltage:
/ALAOM				COM2

## VIII. Circuit theory and formulas

### Series / parallel circuit model

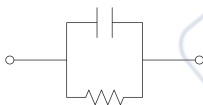
The models and formulas of six types of series and parallel equivalent circuits are shown below: capacitance, inductance and resistance. The formulas include all types of primary and secondary measurements.

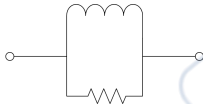
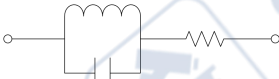
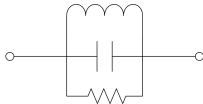
Capacitance (C)	Figure of series	Figure of parallel
		
	Formula for series	Formula for parallel
	$C_s = C_p(1 + D^2)$	$C_p = \frac{C_s}{(1 + D^2)}$
Inductance (L)	Figure of series	Figure of parallel
		
	Formula for series	Formula for parallel
	$L_s = \frac{L_p}{(1 + \frac{1}{Q^2})}$	$L_p = L_s(1 + \frac{1}{Q^2})$
Resistance (R)	Figure of series	Figure of parallel
		
	Formula for series	Formula for parallel
	$R_s = \frac{R_p}{(1 + Q^2)}$	$R_p = R_s(1 + Q^2)$

Formulas to calculate the resistance (R) and conductance (G=1/R)

Resistance measures the physical quantity of the degree of difficulty for the current to

flow through the two terminals. The conductance and resistance are reciprocal. The former measures the degree of ease for the current to flow through the two terminals.

	Resistance	Conductance
	Series resistance $R_s$	Parallel conductance $G_p$ ( $=1/R_p$ )
	Parallel resistance $R_p$	
Formula	$R = \frac{V}{I} = \frac{1}{G} = Z_s - jX$ $= Z_s - j\omega L = Z_s + \frac{j}{\omega C}$	$G_p = \frac{I}{V} = \frac{1}{R} = Y_p - jB$ $= Y_p - j\omega C = Y_p + \frac{j}{\omega L}$
	$ Z_s  = \sqrt{(R^2 + X^2)}$	$ Y_s  = \frac{GB}{\sqrt{(G^2 + B^2)}}$
	$ Z_p  = \frac{RX}{\sqrt{(R^2 + X^2)}}$	$ Y_p  = \sqrt{(G^2 + B^2)}$
	$R_s =  Z  \cos \theta$	$G_p =  Y  \cos \theta$

Formula to calculate the capacitance (C)

Capacitance measures the number of electronic charges stored between the two terminals.

Series capacitance $C_s$	Parallel capacitance $C_p$
$Z_s = R - \frac{j}{\omega C}$	$Y_p = G + j\omega C$
$Q = \frac{1}{\omega C_s R_s}$	$Q = \omega C_p R_p$
$D = \omega C_s R_s$	$D = \frac{G_p}{\omega C_p}$

Formula to calculate the reactance (X) and susceptance ( $B=1/X$ )

Reactance indicates the size of the imaginary component of the impedance (Z) caused by capacitance and inductance. Susceptance and reactance are reciprocal. The value of susceptance equals to the imaginary component of admittance (Y). The admittance and the impedance are reciprocal.

Series reactance $X_s$	Parallel susceptance $B_p$
$X = \frac{1}{B} =  Z  \sin \theta$	$B = \frac{1}{X} =  Y  \sin \theta$

$$|Z_s| = \sqrt{(R^2 + X^2)} \qquad |Y_s| = \frac{GB}{\sqrt{(G^2 + B^2)}}$$

$$|Z_p| = \frac{RX}{\sqrt{(R^2 + X^2)}} \qquad |Y_p| = \sqrt{(G^2 + B^2)}$$

$$X_s = |Z| \sin \theta \qquad B_p = |Y| \sin \theta$$

Formula to calculate the impedance (Z) and admittance (Y=1/Z)

Impedance measures the overall inhibition by the two terminals to the AC. The admittance and the impedance are reciprocal. The former measures the physical quantity of the degree of ease for AC current to flow through the two terminals.

	Impedance (Z)	admittance (Y)
Formula	$Z = \frac{E}{I} = \frac{1}{Y}$	$Y = \frac{I}{E} = \frac{1}{Z}$
	$Z_s = R + jX$	$Y_p = G + jB$
	$= R + j\omega L = R - \frac{j}{\omega C}$	$= G + j\omega C = G - \frac{j}{\omega L}$
	$ Z_s  = \sqrt{(R^2 + X^2)}$	$ Y_s  = \frac{GB}{\sqrt{(G^2 + B^2)}}$
	$ Z_p  = \frac{RX}{\sqrt{(R^2 + X^2)}}$	$ Y_p  = \sqrt{(G^2 + B^2)}$
	$R_s =  Z  \cos \theta$	$G_p =  Y  \cos \theta$
	$X_s =  Z  \sin \theta$	$B_p =  Y  \sin \theta$

Formula to calculate the quality factor (Q) and dissipation factor (D)

The quality factor and dissipation factor are reciprocal. They are used to measure the physical quantity of the energy loss rate at the measurement frequency. Low power consumption: high Q, low D; high energy consumption: low Q, high D.

Quality factor (Q)

Dissipation factor (D)

	$Q = \frac{\omega L_s}{R_s} = \frac{1}{\omega C_s R_s}$	$D = \frac{R_s}{\omega L_s} = \omega C_s R_s$
Formula	$= \frac{R_p}{\omega L_p} = \omega C_p R_p$	$= \frac{G_p}{\omega C_p} = \omega L_p G_p$
	$= \frac{1}{\tan(90 - \theta)^\circ} = \frac{1}{D}$	$= \tan(90 - \theta)^\circ = \frac{1}{Q}$

Formula to calculate the phase angle ( $\theta$ )

Phase angle ( $\varphi$ ) refers to the phase of measured impedance (Z), admittance (Y), quality factor (Q) and dissipation factor (D).

Phase angle ( $\theta$ )

$Z_s = R + jX$	$Y_p = G + jB$
$= R + j\omega L = R - \frac{j}{\omega C}$	$= G + j\omega C = G - \frac{j}{\omega L}$
$Q = \frac{1}{\tan(90 - \theta)^\circ} = \frac{1}{D}$	$D = \tan(90 - \theta)^\circ = \frac{1}{Q}$
$R_s =  Z  \cos \theta$	$G_p =  Y  \cos \theta$
$X_s =  Z  \sin \theta$	$B_p =  Y  \sin \theta$

### Principles and formulas for open and short circuit correction

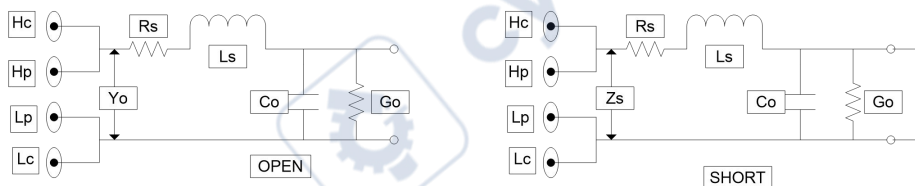
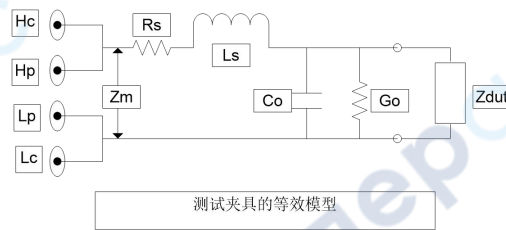

Open circuit measurement: because  $R_s + j\omega L_s \ll \frac{1}{G_o + j\omega C_o}$  so

$$Y_o = G_o + j\omega C_o$$

Short circuit measurement:  $Z_s = R_s + j\omega L_s$

Correction model is as follows

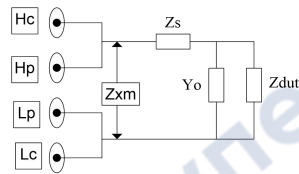

$$\text{Correction formula: } Z_{dut} = \frac{Z_{xm} - Z_s}{1 - (Z_{xm} - Z_s)Y_o}$$

Dut: impedance of DUT

Zxm: impedance value measured by the instrument

Yo: stray capacitance admittance

Zs: impedance value of the remaining impedance

## **IX. Notes and warranty**

### **9.1 Packaging**

The measuring instrument with its accessories, components, instruction, and production qualification certification should be placed in the plastic bag and stored in the solid box against dust, vibration and moisture.

### **9.2 Transport**

Handle the measuring instrument with care during transport. Keep it away from moisture and rain.

### **9.3 Storage**

The measuring instrument should be stored in a ventilated room with a temperature of 5°C ~ 40°C and a relative humidity of 15% to 85%. There should be no harmful impurities in the air to corrode the instrument.

### **9.4 Warranty**

The maintenance of the instrument should be conducted qualified by technicians; please do not replace the internal components of each instrument during maintenance; after the maintenance, the instrument needs recalibration, so as not to affect test accuracy. The user shall undertake the maintenance fees for the damage not within the scope of warranty which is caused by the arbitrary maintenance by the user or the replacement of the components.