

MINI OTDR

Manual



Version E0000

Foreword

Thank you for purchasing MINI OTDR (Optical Time Domain Reflectometer). This user's manual contains useful information about the instrument's functions and operating procedures and the handling precautions of MINI OTDR OTDR. To ensure correct use, please read this manual thoroughly before beginning operation. After reading the manual, keep it in a convenient location for quick reference whenever a question arises during operation.

Note

- The contents of this manual are subject to change without prior notice as a result of continuing improvements to the instrument's performance and functions. The figures given in this manual may differ from those that actually appear on your screen.
- Every effort has been made in the preparation of this manual to ensure the accuracy of its contents. However, should you have any questions or find any errors, please contact your nearest Company dealer.
- Copying or reproducing all or any part of the contents of this manual without Company's permission is strictly prohibited.

Trademark

- Microsoft, Windows, and Windows XP are either registered trademarks or trademarks of Microsoft Corporation in the United States and/or other countries.
- Adobe and Acrobat are trademarks of Adobe Systems Incorporated.
- For purposes of this manual, the TM and ® symbols do not accompany their respective trademark names or registered trademark names.
- Other company and product names are trademarks or registered trademarks of their respective holders

Version

Version 1.0 2012

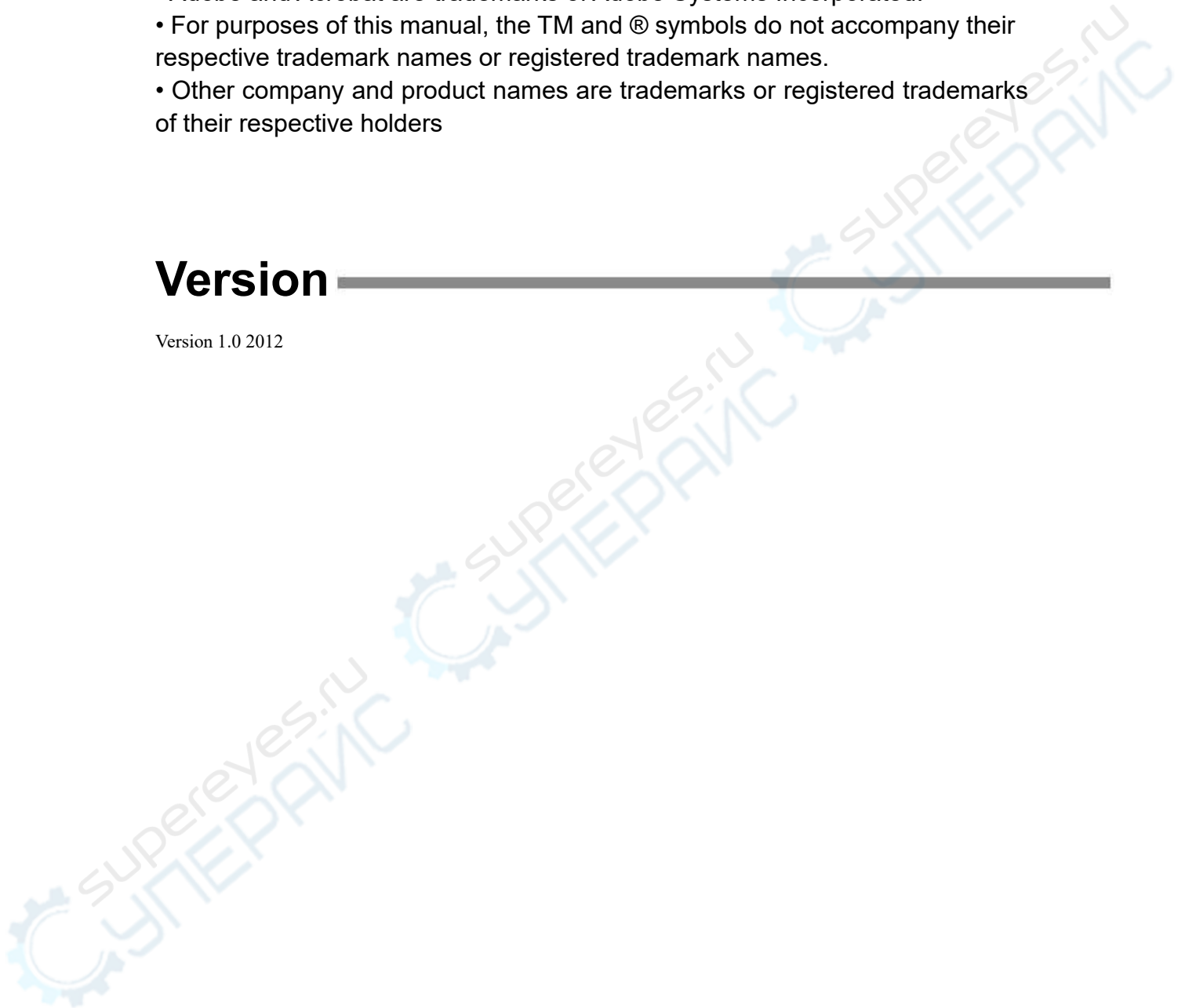

Standard Accessary

OTDR standard accessory showed in next table.

Num.	Description	Quantity
1	Power Adapter(220V 50Hz)	1
2	Power Patchcord	1
3	Data Cable	1
4	CD	1
5	Carrying Case	1
6	Securing Strip	1
7	Manual	1

Module

OTDR optional accessory showed in next table.

Num	Module	Description
1	OTDR module	Standard
2	VFL(visual fault locator) module	Optional
3	OPM(optical power meter) module	Optional

✘ All changes with standard accessory and optional accessory prices are subject to change without notice..

Safety Precautions

To use the instrument safely and effectively, be sure to observe the precautions given in the user's manual. Not complying might result in injury or death.

Warning

Use the Correct Power Supply

Before connecting the power cord, ensure that the source voltage matches the rated supply voltage of the AC adapter and that it is within the maximum rated voltage of the provided power cord.

Use the Correct Power Cord

Use only the power cord that comes with the instrument. Do not use it for other devices.

Use the Correct AC Adapter

Use only the AC adapter specified for the instrument. Do not use it for other devices.

Use Only the Designated Battery pack

Use only the battery pack specified for the instrument. Do not use it for other devices.

Use only this instrument or a charger specified by Company to charge the battery pack. If the fast charge does not finish after three hours or more, stop charging the battery pack immediately.

To prevent the possibility of electric shock and accidents, always turn OFF the power switch and remove the AC adapter power supply from the instrument when replacing the battery pack.

Do not throw the battery pack into fire or apply heat to it. This can cause dangerous explosions or spraying of the electrolytes.

Do Not Look at the Laser Light

Do not look at the laser's direct ray, reflected ray from a mirror, or indirect ray without the proper protective eyewear. In addition, avoid being exposed to the laser light. It can cause blindness or damage to the eye.

Do Not Operate in an Explosive Atmosphere

Do not use the thermocouple in a location where any flammable or explosive gas/vapor is present. Operation in such an environment constitutes a safety hazard.

Do Not Remove Covers

The covers should be removed by Company's qualified personnel only.

Opening the cover is dangerous, because some areas inside the instrument

have high voltages.

Carrying and Moving the Instrument

Remove all power cords and connection cables from the main unit before moving the instrument. When carrying the instrument, hold it firmly by the handle. Also, if storage media is inserted into the instrument, always remove the storage media before carrying or moving the instrument. Never leave the media inserted when carrying or moving. The storage media can become damaged.

Apply Correct Signals to the Optical Connectors

Do not apply light that is -10dBm or greater to the MINI OTDR optical Connectors.

Doing so may damage the MINI OTDR



Symbol

Icons on the main body or in manual



Warning: handle with care. Refer to the user's manual or service manual.

This symbol appears on dangerous locations on the instrument which require special instructions for proper handling or use. The same symbol appears in the corresponding place in manual to identify those instructions



Hazard, radiation of laser apparatus



Ni-MH

Recycle



Direct current



Stand-by (power)



Comply WEEE(Waste Electrical and Electronic Equipment) Directive (2002/96/EC)

Content

0.0 Names and Functions of Parts	11
0.1 Panel	12
0.2 Main Menu Interface	13
0.3 OTDR Module Interface	14
0.4 VFL Module Interface	16
1.0 Preparation	18
1.1 Turning on	18
1.2 Connecting the Fiber	19
2.0 Introduction of OTDR	20
2.1 Purpose of Measurement	20
2.2 Content of Measurement	21
2.3 Analyze of Curve	22
2.4 Fundamental of OTDR	24
2.5 Event Type	26
3.0 Setting Measurement Conditions	28
3.1 Setting to Auto Mode	29
3.2 Setting to Manual Mode	30
4.0 Making Measurements	32
4.1 Averaging test mode	32
4.2 Realtime test mode	33
4.2.1 Setting wavelength	34
4.2.2 Setting test range and pulse width	35
4.3 Event List	36
4.4 Distance Measurement	37
4.5 OTDR Optimizing Tool	38
4.6 Setting proper parameters	40
5.0 Expanding the Waveform and Moving the Display Area	42
5.1 Switching between Event list and display window	42
5.2 Cursor Operation	42
5.2.1 Activating Cursor	43
5.2.2 Moving Cursor	44
5.3 Curve Operation	44
5.3.1 Horizontal Zoom	44

5.3.2	Vertical Zoom.....	45
5.3.3	Horizontal Shift.....	47
5.3.4	Vertical Shift.....	48
5.4	Elaborating Event.....	49
5.5	Switching between curves.....	50
5.5.1	Removing Curve(s).....	51
5.6	Removing an event.....	52
5.7	Adding an event.....	53
6.0	File Operation.....	54
6.1	Saving Curve.....	54
6.2	Loading Curve(s).....	55
6.3	Deleting Curve(s).....	56
6.4	Copying/Moving Curve(s).....	56
6.5	File Setting.....	57
6.6	Print screen.....	58
7.0	Entering Characters.....	59
7.1	Renaming.....	59
7.2	Creating Directory.....	59
8.0	FLM Test (Optional).....	60
9.0	VFL(Visual Fault Locator) Module.....	62
10.0	OPM(Optical Power Meter Module)(Optional).....	63
11.0	Software Update.....	64
12.0	Background Information on Measurements.....	65
12.1	Viewing the Optical Pulse Measurement Waveform.....	65
12.2	Terminology.....	66
13.0	Maintenance.....	67
13.1	Notice.....	67
13.2	Cleaning Tools.....	67
13.3	Cleaning of Optical Port.....	68
13.4	Calibration.....	68
14.0	Diagnosis Center.....	69
14.1	FAQ.....	70
14.2	Help information.....	71

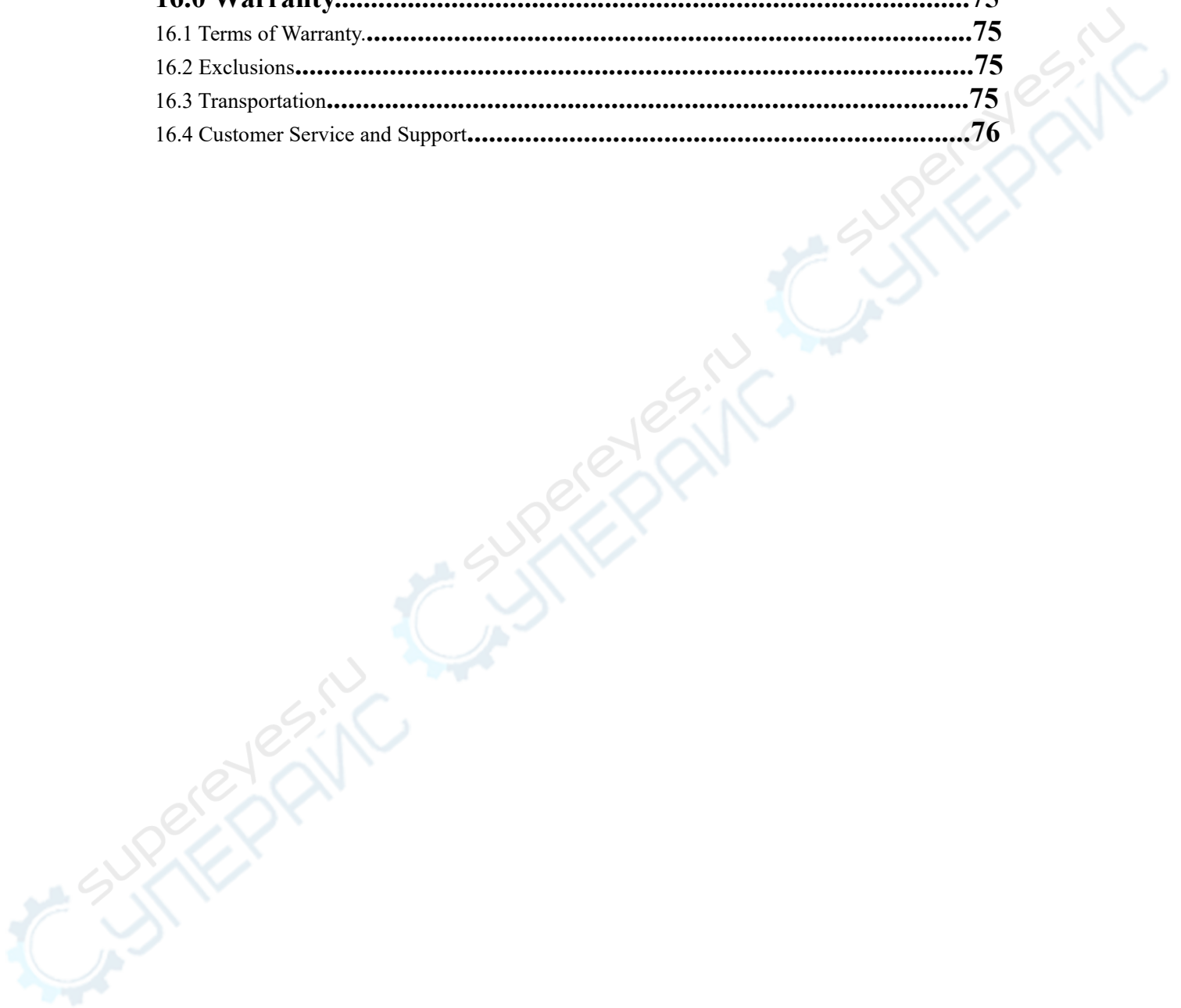

15.0 Specification	72
15.1 Physical Parameter.....	72
15.2 Test Index.....	73
15.3 Dimension.....	74
16.0 Warranty	75
16.1 Terms of Warranty.....	75
16.2 Exclusions.....	75
16.3 Transportation.....	75
16.4 Customer Service and Support.....	76

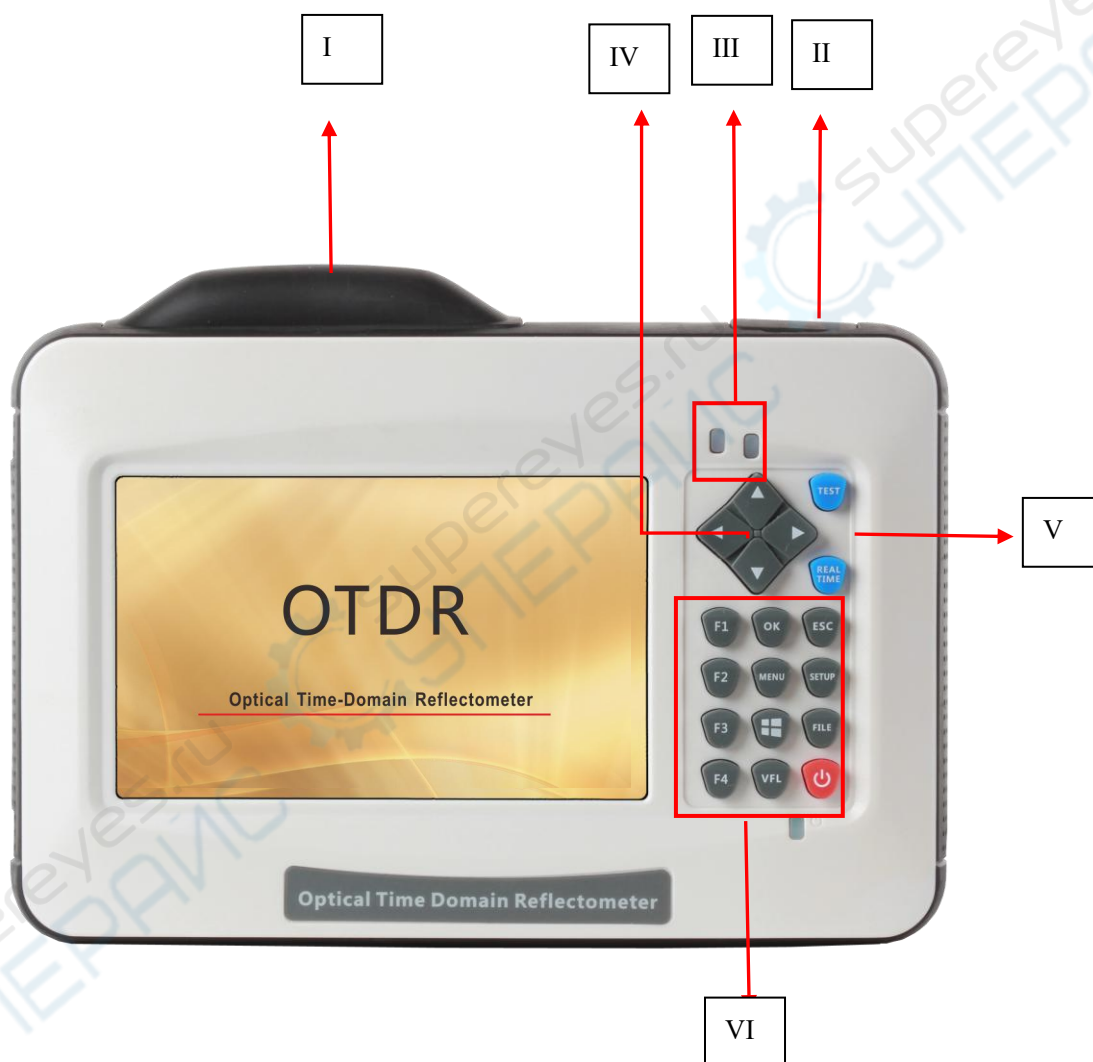

0.0 Names and Functions of Parts

0.1 Panel



Num	Name	Description
I	Port 1	Including OTDR Test port (FC/UPC), Visual Fault locator port(optional)×1、 Power Meter port(optional) ×1 , touch pen×1 and USB A type×2
II	Port 2	Including micro-USB×1 and charging port
III	Indicator	Indicate test and power state
IV	Direction Buttons	Move cursor, menu or files
V	Test button	Averaging Test (TEST) and Realtime Test (REALTIME) button
VI	Button area	<p>F1 ~ F4 : Select relative tag menu</p> <p>OK : Confirm setting or enter menu</p> <p>ESC : Cancel setting or enter menu</p> <p>MENU : Back to main menu</p> <p>SETUP : Set test parameters</p> <p>FILE : File manager</p> <p>VFL : visual fault locator menu</p> <p> : Printscreen</p> <p> : Power switch</p>

0.2

Main Menu Interface

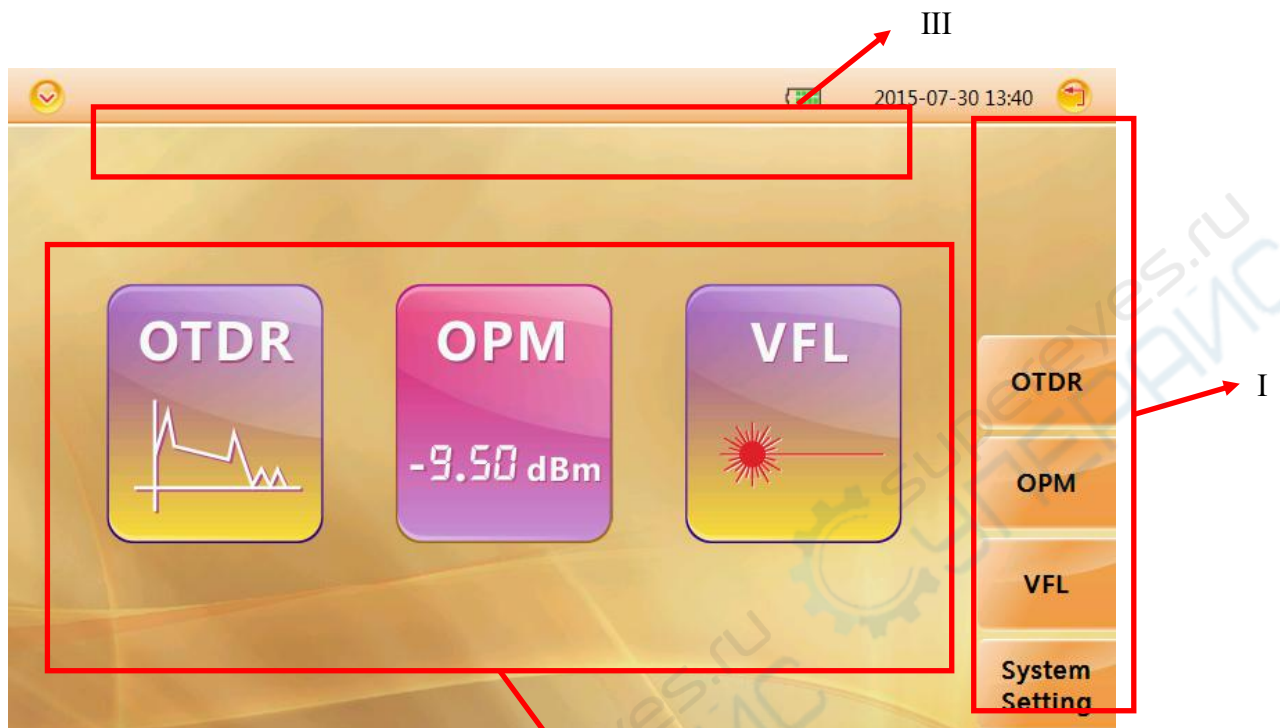

Num	Function	Description
I	Side menu	Enter relevant interface
II	Function Modules Area	Enter relevant module
III	Basic State Information Area	Display information of date ,time and power

0.3

OTDR Module Interface

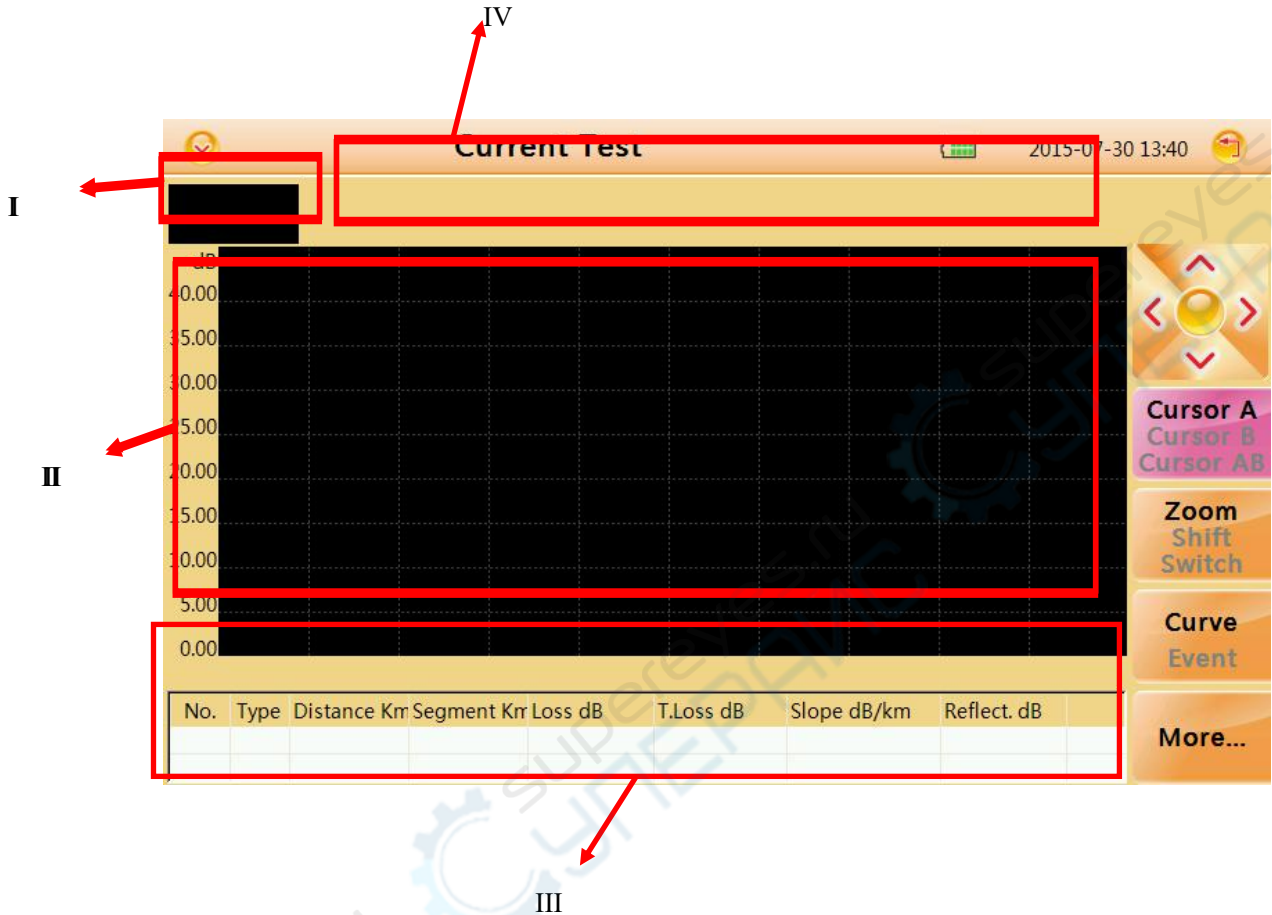

Num	Function	Description
I	Thumbnail of current curve	For user's reference to the integrated curve
II	Curve display and operating area	Display events and curves
III	Event list	Display event information

	area	including:"Type","distance(Km)","Loss(dB)","T.Loss(dB)","Slope(dB/km)" and "Reflection(dB)"
IV	Test condition information area	Display condition information of test including"PW"(Pulse width), "WL"(wavelength),resolution of X axis and Y axis(dB/div),distance,averaging and total loss from cursor A to cursor B.

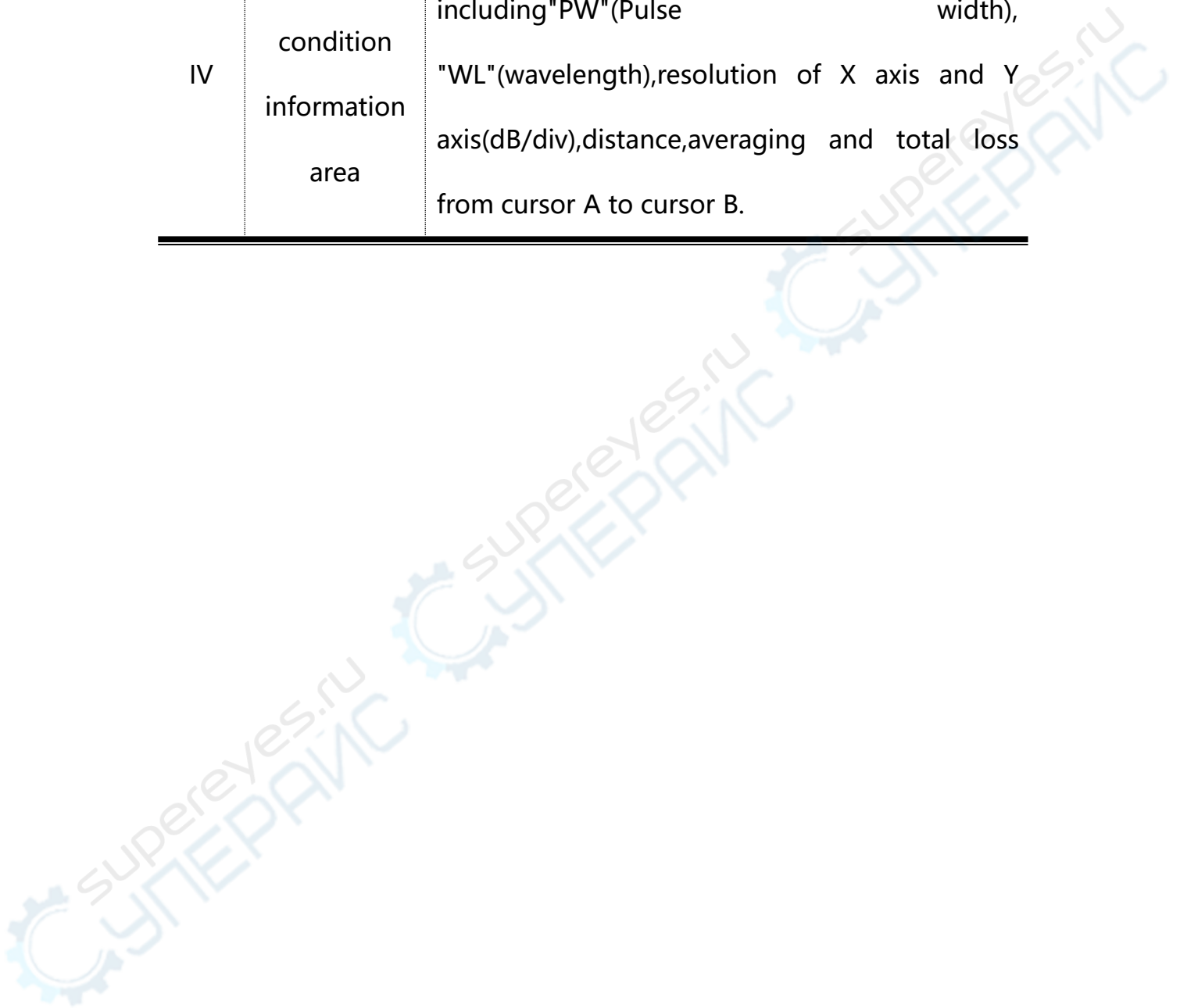

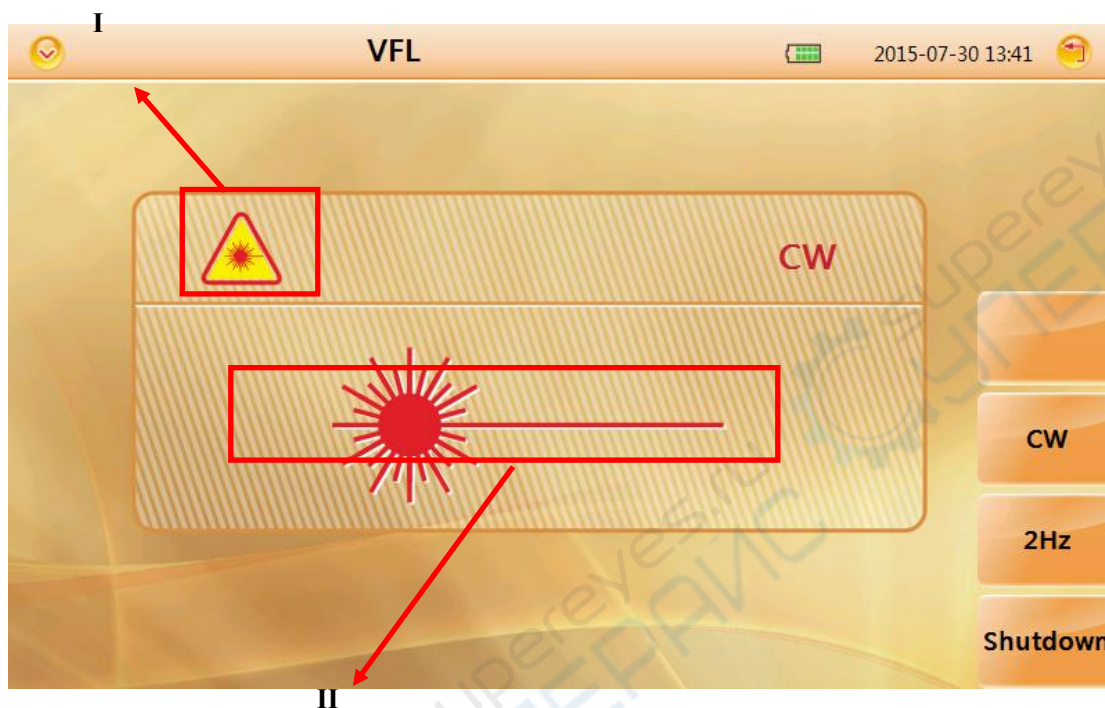

Num.	Function
I	VFL mode indicator
II	Launching state indicator

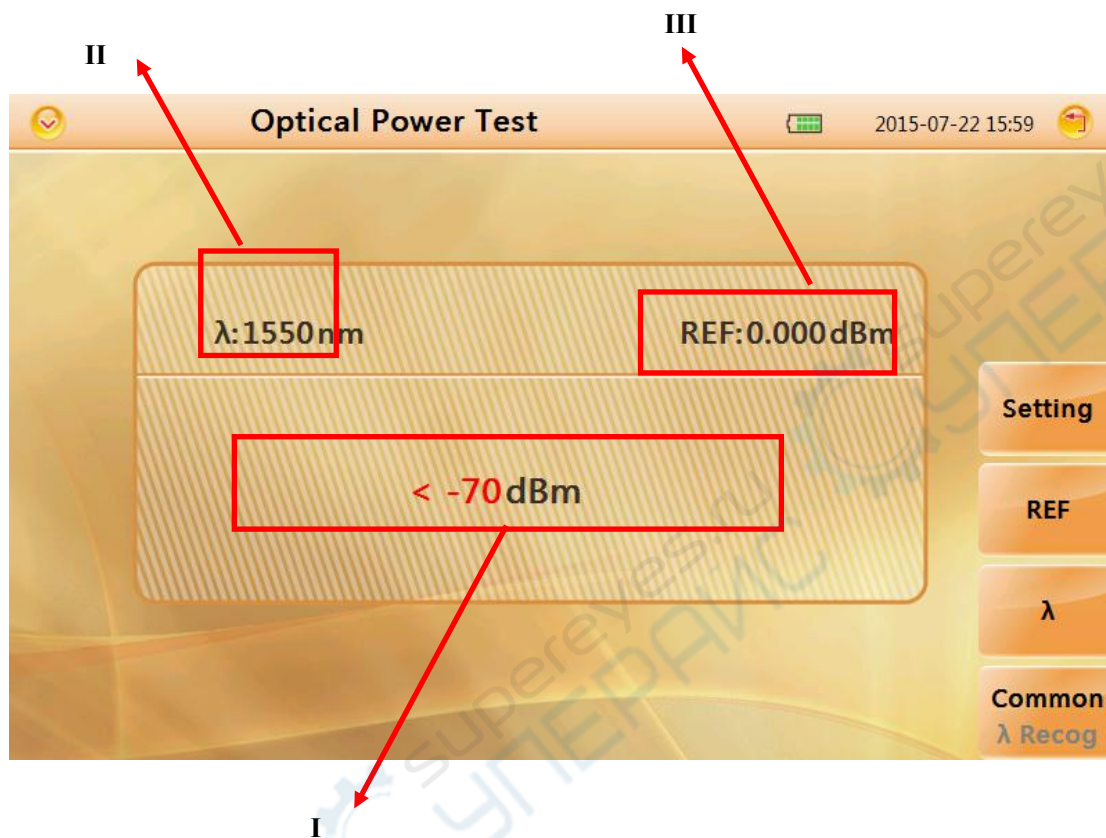

Num.	Function
I	Power value display
II	Wavelength channel
III	Reference value

1.0

Preparation

1.1

Turning on

Press power button(>2s) to turn on OTDR, power state indicator turns green .when power is low some warning information will display on the screen.

Power state indicator

Green light: Working state or fully charged

Red light: Charging state

Launching state indicator

Green light: Proceed realtime test

Red light: Proceed averaging test

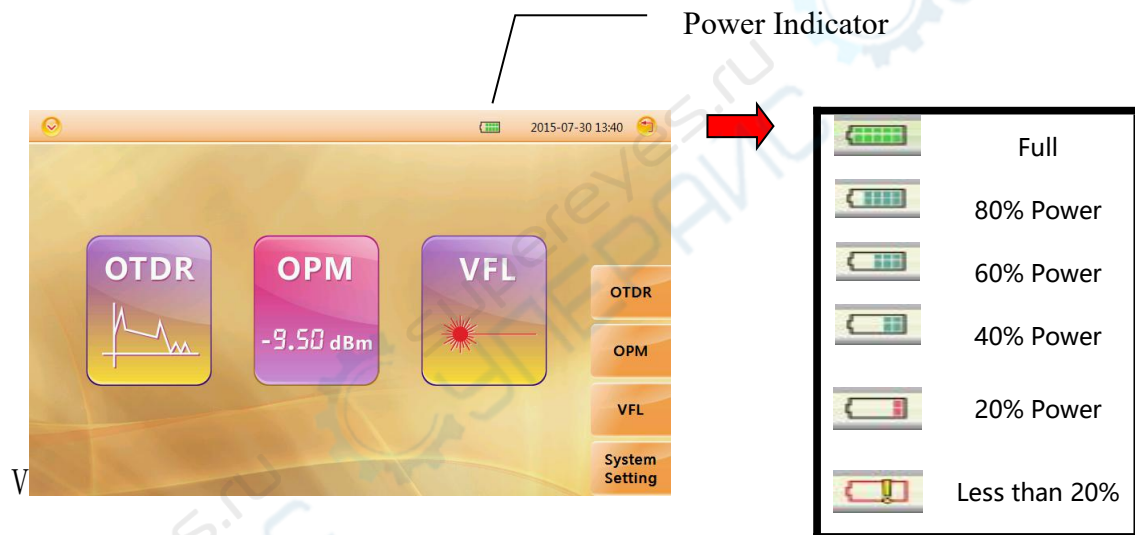

Caution

- In case of low power, special icon will appear, and after that for a while MINI OTDR will turn off automatically.
- If it has not been used for an extended period of time, MINI OTDR will turn off immediately after turned on to protect the internal battery ,please connect the AC adapter adapter.
- Proper charging temperature is: -10~50°C ,high charging temperature may shorten battery life.
- Charging time is about 5 hours with power on, about 3 hours with power off.
- Don't charge battery more than 8 hours.

1.2

Connecting the Fiber

Before connect fiber to MINI OTDR, clean fiber end first ,the dust which on the end of connector may damage the optical port or reduce test quality.

Procedure :

1. Put connector against the cleaner.
2. press the handle of cleaner.
3. Rub each other carefully to clean the contaminant.
4. Repeat procedure 1 and 3.
5. Open the protecting cover of optical port.
6. Insect connector into optical port carefully.

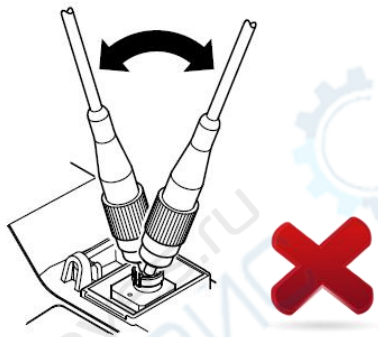
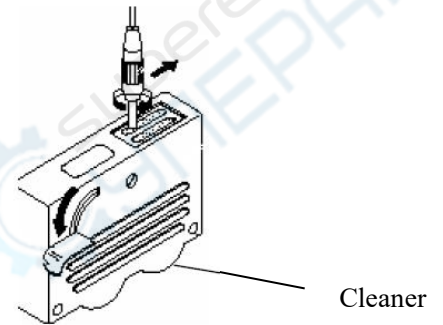

Caution

Insect connector carefully into optical port , unproper operation may cause the damage of optical port.



Warning

Before connection make sure that there is no optical signal exist inside the fiber,any signal which is larger than -30dBm will disturb the sampling of OTDR,even cause permanent damage of sensor.

2.0 Introduction of OTDR

2.1 Purpose of Measurement

OTDR shows the back-scatter light power of the optical signal relative to the distance. With this information, the OTDR could measure a series of important information of an optical fiber such as the quality of the line, distance of the line and etc.

2.2 Content of Measurement

- Event position----- a broken point or the end of the tested fiber
- Optical attenuation coefficient of a optical fiber
- Single event loss, such as the loss of a connection or a macro bending. Or the loss of a end-to-end line on the tested optical fiber

2.3 Analyze of Curve

OTDR can auto analyze a tested trace, the position process shows below:

- Get the reflection events generated by connectors or mechanical splicer.
- Non-reflection events(usually it is splicing points or macro bending).
- End: the first point which the loss of it is over the threshold would be scanned as the end of a trace.
- Events list: event type, loss, reflection and distance.

Normal Curve

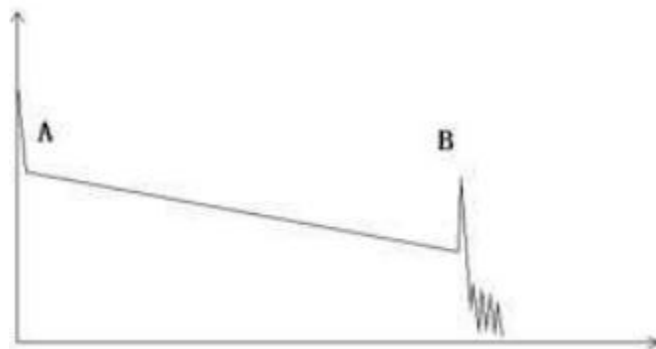

A normal trace shows as above, the A mark is a start-peak and the B mark is a end-reflection-peak. The tested trace is oblique, the total loss will become bigger with the increasing of the fiber length. The total loss(dB) divides total length is the average loss(dB/km) of a fiber.

Curve with Jumper Connected



If there is additional reflection peak in a tested trace, this may be caused by a connection point or some other reasons. Anyway, appearance of the reflection peak shows that the two connecting surfaces of the connection are smooth. The smoother the connection surfaces are, the higher the reflection peak is.

For an instance, if a broken optical line is under test, the OTDR trace will show a broken point. After a maintenance of this line, use the OTDR test it again, we may see a reflection peak replacing the broken point on the OTDR trace, this shows the maintenance is done.

Curve with Broken Point



If the tested trace is just like the figure shows above, this might be caused by several reasons like: a bad connection between the connector and the launching port, the optical pulse cannot be launched into the optical fiber or a short distance broken point of the tested fiber from the initial connection and the preset testing distance and pulse width is larger.

To fix this problem, we should:

1. Check the connection of the connector and the launching point
2. Reset the test parameters, decrease the preset distance and the pulse width.

If the problem still exists, we could estimate:

1. The connector of the test fiber is broken or polluted.
2. The launching port on the OTDR is broken or polluted.
3. The distance of the broken point of the from the initial connection is too close.

Curve with Non-reflective Event



There is a common phenomenon that an obvious step is on the middle of a tested trace, it often caused by a fiber bending, fiber knot, being pressed by something heavy or a fuse splicing point. The step means a bigger loss of a fiber, it is also called event point. If the direction of it is downward, it could be called non-reflection event. If the direction is upward, we can call it reflection event.

Sometimes, the loss value could be a negative value, it does not means the loss does not exist. It is common phenomenon called pseudo gain, it is by a connection of two fibers with different back scatter coefficient, the scatter coefficient of the back fiber is large than the front one's. In addition, the different refract ratio also can cause the phenomenon. To avoid it, we could test a fiber bi-directionally.

Abnormal Condition



The situation that there is no reflection peak at the end of a trace shows above should be paid attention on. If the distance of the tested fiber is available and the distance shown on OTDR is not equal to the original distance, this shows that the fiber might be broken down or twisted and the bending radius of it is over limited. The distance shown on OTDR is the position of the fault point.

This phenomenon is often used in maintenance. If a fiber is uncertain, we can bend a fiber and make sure the bending radius is over limited, then use real time testing function of the OTDR to confirm the fiber.

Distance is Too long



This situation often happened in a long distance testing, caused by under-range dynamic range of the OTDR that the energy of it can not support a long distance transmission or caused by a under-range preset testing range of distance or pulse width corresponding to the actual fiber length.

To avoid this situation, adjust the testing distance and the pulse bigger and extend the sampling time.

2.4 Fundamental of OTDR

OTDR—Optical Time Domain Reflector is a high precision optical testing meter that use the theory of Rayleigh scattering and Fresnel reflection. It is widely used in the maintenance, construction and monitoring of an optical line. All the important parameters like fiber length, optical loss, connection loss, broken or twisted point and etc. of a fiber can be shown on the OTDR. When the a light transmits along a fiber, it would be scattered to various directions caused by the difference of come properties of the transmission medium, this phenomenon called Rayleigh scattering. During the scattering process, some of the light will be scattered along the absolutely converse direction, this phenomenon is called Rayleigh back-scattering. It provides some details about the fiber length. The parameters about fiber length can be got by calculation with the parameter of time(This is the derivation of TD in OTDR—Time Domain).

These back-scattering signals shows the loss level of a fiber and through these information, OTDR can generates a backward oblique trace which reflects several important attributes of a optical fiber. When the light, transmitting downward along the fiber, meet a different density medium, a part of the light will be reflected, this phenomenon is called Fresnel reflection. There are many reasons can cause the changing of the medium density like a little slot at the splicing point, a broken of fiber or etc. This phenomenon is usually used to locate the discontinuous point. Compare to the Rayleigh scattering, the consuming amount of the light in Fresnel reflection is much more then it is in Rayleigh scattering. The power of Fresnel reflection is tens of thousands times to the back-scattering's. The reflection level depends on the changing grade of refraction ratio.

Formula of the distance: $\text{distance} = (c/n) \times (t/2)$

Here: **c** is the light speed traveled in vacuum($2.998 \times 10^8 \text{m/s}$)

t is the delay between launching pulse and receiving pulse

n is the refraction ratio of the testing fiber(specified by manufacturer)

When display the whole trace, each point of the trace represents the average value of several sampling points. By zoom in and zoom out function, the value of each sampling point can be got.

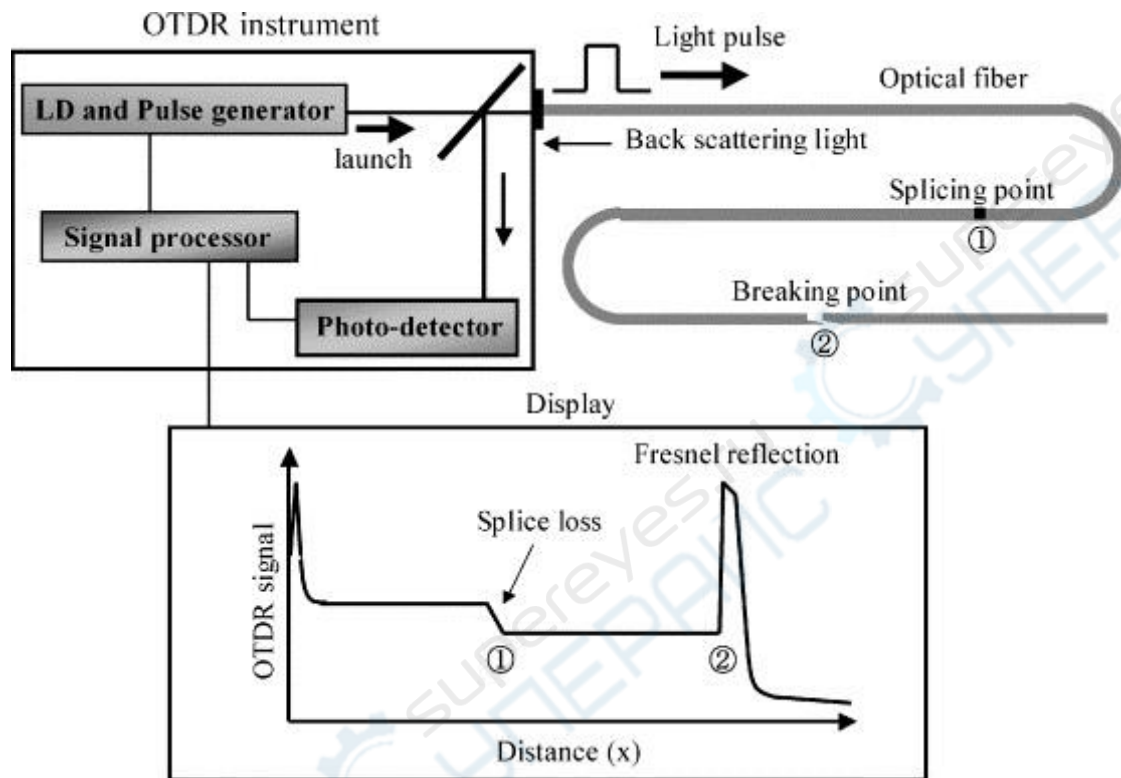

Working Principle of OTDR

2.5

Event Type

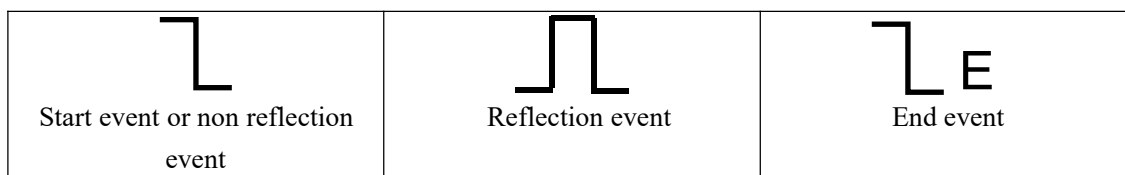

Types of event

The events on trace are all the points that the value of power loss fluctuates abnormally. It usually contains various types of connection and bending, crack, broken and etc. The event points marked on trace with special marks are the abnormal points in a fiber that cause the excursion of a normal trace.

The events can be divided into Reflection-event and Non-reflection-event

Start event

The Start-Event on a OTDR trace is the initial point. Under the default setup, Start-Event is located on the first event(usually it is an connection between the OTDR launching port and the connector of a fiber) of a fiber. It is a Reflection-event.

End event\

The End-Event on a OTDR trace is the end point of a fiber. Under the default setup, End-Event is located on the last event(usually it is an end face or a broken down point of a fiber). Usually, it is a Reflection-event.

Reflection-event

The phenomenon on a trace that some power of the optical pulse is reflected called a reflection event. Reflection-event is displayed as a peak signal on a trace.

Non-reflection-event

The phenomenon on a trace that there exists some abnormal loss in a optical line, but no reflection occurred is called a Non-reflection-event. It is displayed as a drop with no peak on a trace.

Event detection

OTDR launches a bunch of optical pulse into a under-test fiber, receives the returned optical signal and starts calculating the distance

from a event. The more the distance from the event is, the longer the returning time is cost. According to the receiving time,distance can be calculated. By detecting the trace generated by the returned optical signal, the attributes of the fiber itself, the connector of the fiber, adaptor in the fiber and splicing point in the fiber can be confirmed.



3.0 Setting Measurement Conditions

Press **【SETUP】** button on the panel to enter test setting interface

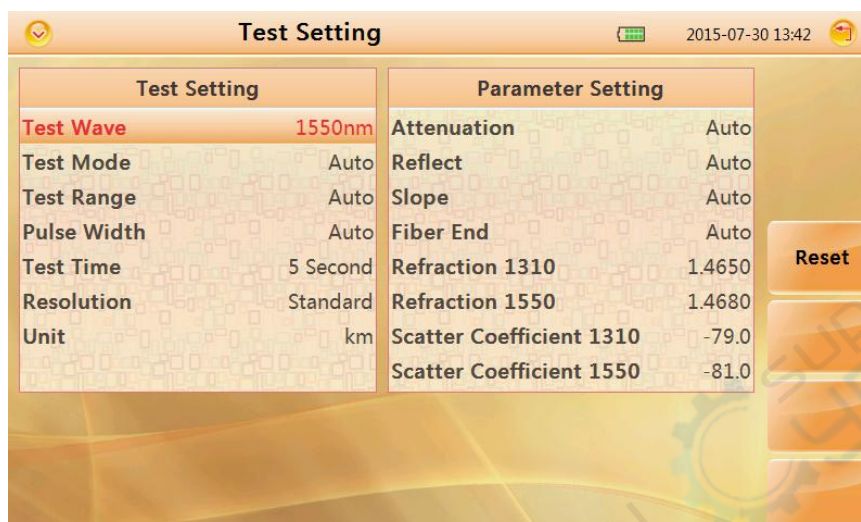

The meaning of items indicated in the following table:

Test Wave	Test Wavelength of OTDR, including 1310nm,1550nm and 1310nm&1550nm 3 kinds of mode
Test Mode	Auto Mode: MINI OTDR will set best parameters for current test Manual Mode: set parameters manually
Test Time	Under averaging test mode(TEST),longer test time has better SNR (Signal Noise Ratio) but takes more time .
Test Range	Test distance of OTDR .adjust only in manual mode,in auto mode this item set as "Auto"
Pulse Width	Wider pulse has stronger backward signal, OTDR has longer detecting distance but wide pulse width will cause the saturation of backward signal, make blind area bigger.so the selection of pulse width has close relationship with the length of fiber. Long fiber has wide pulse width.. pulse width could only modified in "Manual"mode.
Resolution	Sampling resolution of test high resolution has more sample point and high precision,but take more memory space
Unit	Unit of test result,including km/kfeet/miles

3.1 Setting to Auto Mode

In Auto mode, you could just proceed test by setting proper wavelength.

Procedure:

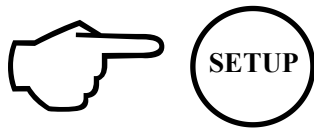

1. Press **【 SETUP 】** button to enter "Test Setting" interface

2. Set "Auto" mode

3. Set test wave

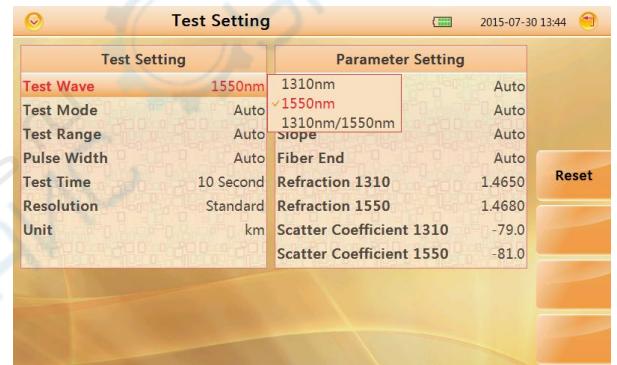
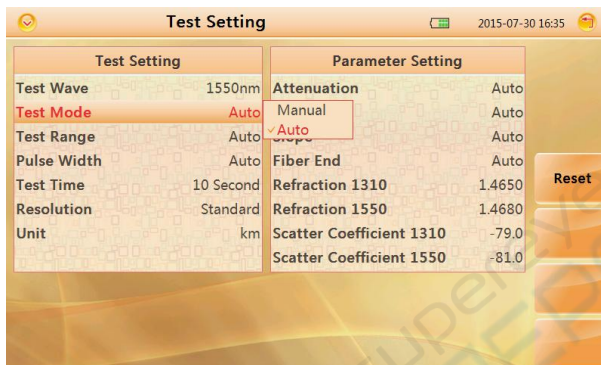

Caution

Auto test mode is not suitable to proceed Blind area test, user should enter "Manual" mode and choose "Blind area test" to proceed blind area test.

3.2

Setting to Manual Mode

In manual mode, user could set proper range and pulse width manually.

Procedure:



1. Press **【 SETUP 】** button to enter "Test Setting" interface

2. Set "Manual" mode

3. Set test wave

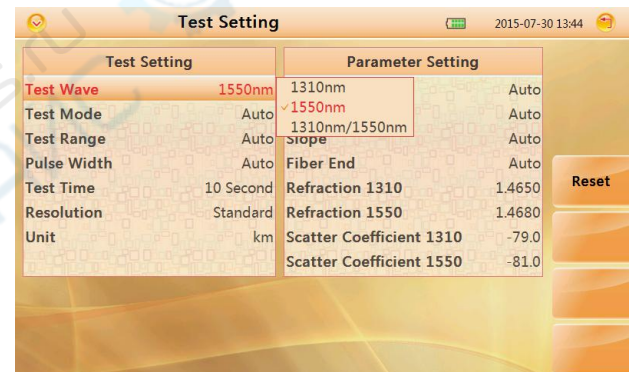
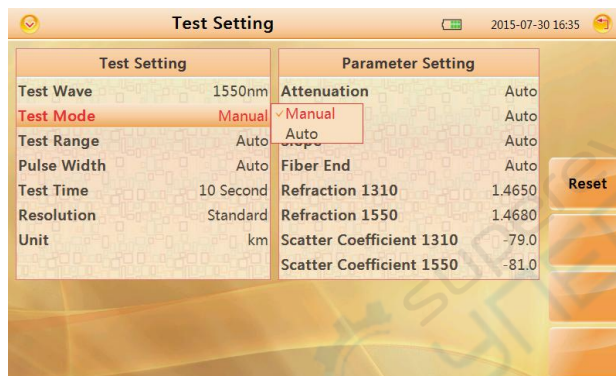

4. Set range and pulse width

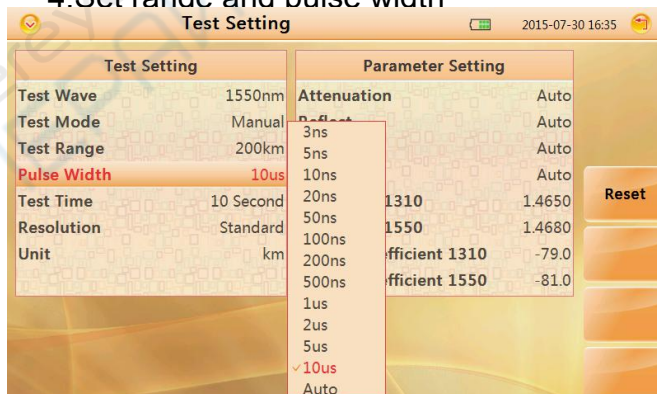

Caution

- When "Pulse width" set to "Auto", test will choose proper pulse width automatically
- When "Test Range" set to "Auto", test will choose proper range automatically
- Once you set the "Test range", "Pulse width" item will adjust automatically you could also adjust manually

Proper relationship between Range and pulse width(PW) (For user's reference only.):

MR \ PW	100m	500m	2km	5km	10km	20km	40km	80km	120km	160km	240km
3ns	✓	✓	△	△	△	△	△	△	△	△	△
5ns	✓	✓	✓	△	△	△	△	△	△	△	△
10ns	△	✓	✓	✓	△	△	△	△	△	△	△
20ns	△	✓	✓	✓	✓	△	△	△	△	△	△
50ns	△	△	✓	✓	✓	✓	△	△	△	△	△
100ns	△	△	△	✓	✓	✓	△	△	△	△	△
200ns	△	△	△	△	△	✓	✓	△	△	△	△
500ns	△	△	△	△	△	△	✓	✓	△	△	△
1us	△	△	△	△	△	△	✓	✓	✓	△	△
2us	△	△	△	△	△	△	△	✓	✓	✓	△
5us	△	△	△	△	△	△	△	✓	✓	✓	✓
10us	△	△	△	△	△	△	△	△	✓	✓	✓
20us	△	△	△	△	△	△	△	△	△	△	✓

4.0 Making Measurements

MINI OTDR has two test modes: averaging test mode and realtime test mode.

4.1 Averaging test mode

Averaging test mode can calculate the data of curve over a period of time and display as a averaging one ,test time could set "Test Time" in "Test Setting".

Press **【TEST】** button on the control panel, test state indicator turns red,enter averaging test interface.

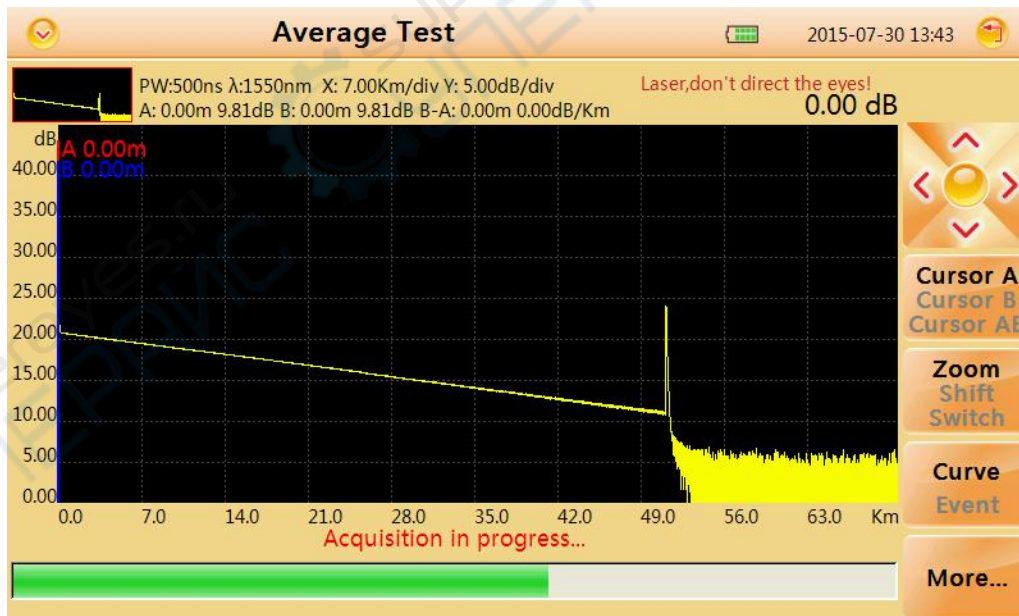
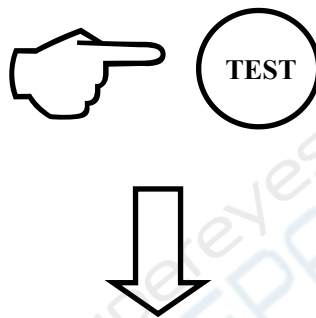

Averaging test interface

4.2 Realtime Test Mode

Realtime test mode could check network , adjust test range and pulse width in real-time.

Press **【 REALTIME 】** button on control panel, test state indicator turns green,enter realtime test interface.

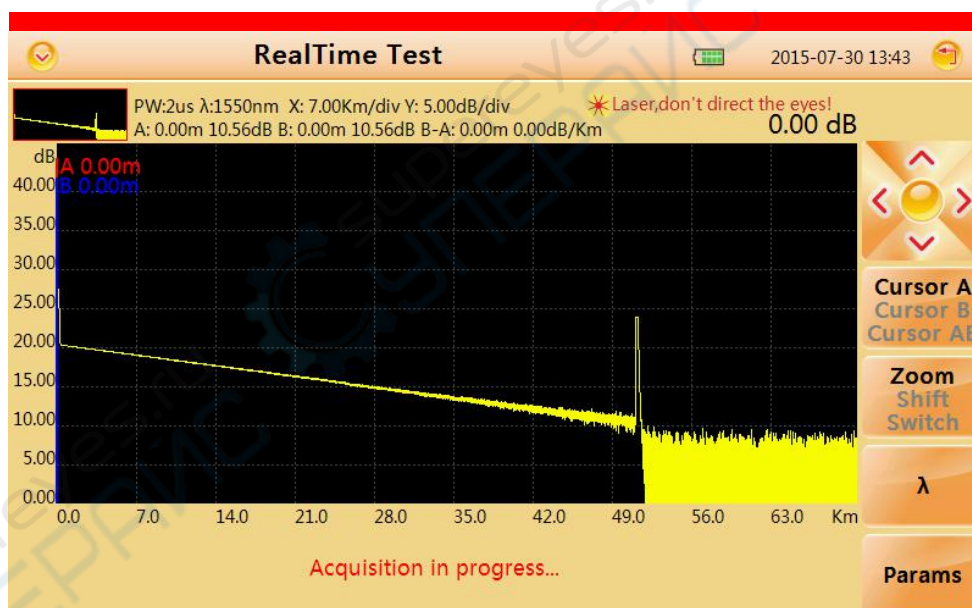
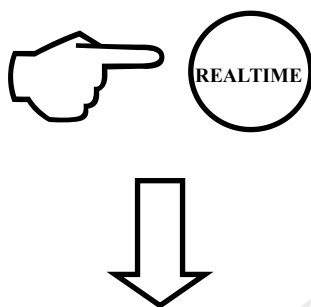

Realtime test interface

4.2.1 Setting Wavelength

Procedure :

1. Select wavelength (WL) tag to set wavelength(1310nm or 1550nm).
2. Confirm by **【OK】** button.

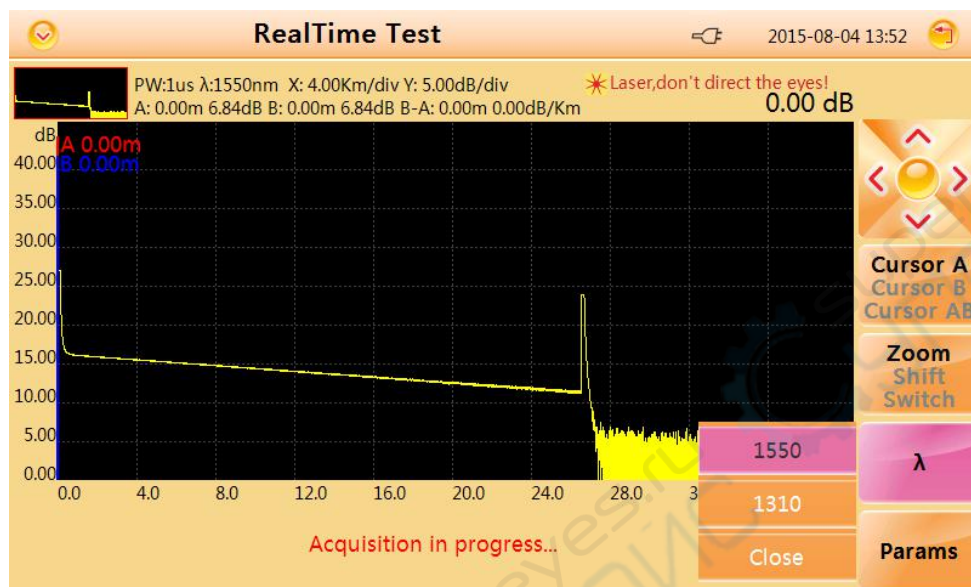

4.4.2 Setting Test Range and Pulse Width

Procedure :

1. Select tag "Params" to set Test range(range) and Pulse width(PW).
3. Confirm by **【OK】** .



4.3 Event List

After test, event list will appear immediately at the bottom of the window, user could get detail information about this test from the list.

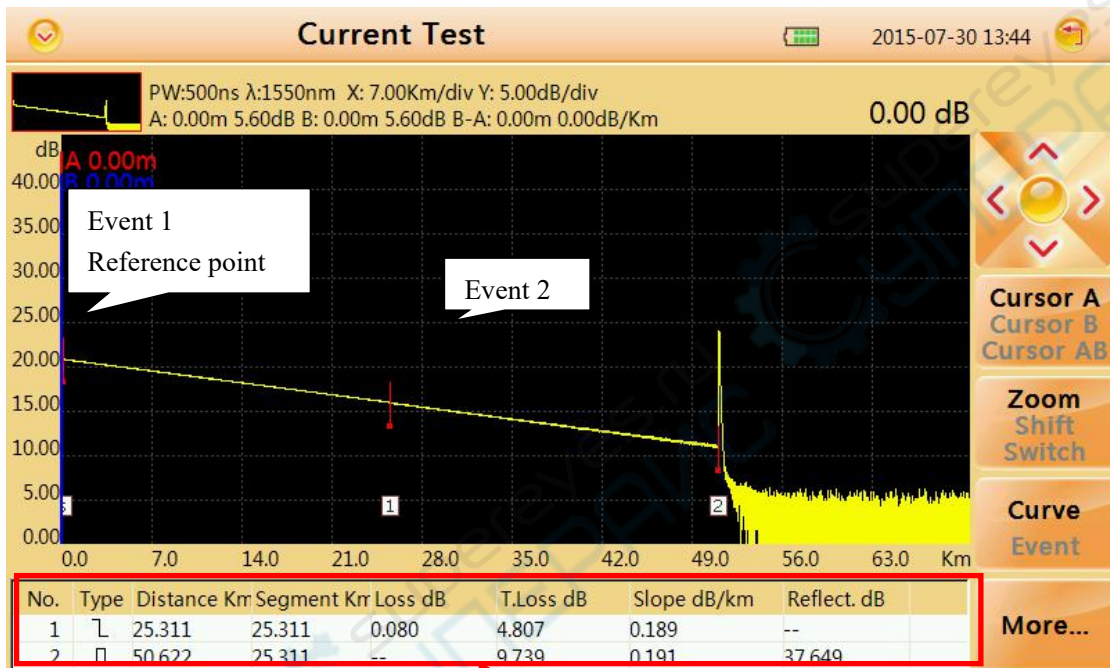

Event List

Description of items showed in chart below:

Num	Item	Description
I	Type	Type of event (Attenuation events , Reflection events and End event)
II	Distance	Distance from start point to event
III	Section	Distance from this event to last event.
IV	Loss	Loss of this event(dB)

V	T. Loss	Total loss from start event to this event(dB)
VI	Slope dB/km	Ratio of event loss value (dB) (from this event to last event)to distance (km) (distance from this event to last event)
VII	Reflect.dB	Return loss of this event(dB)

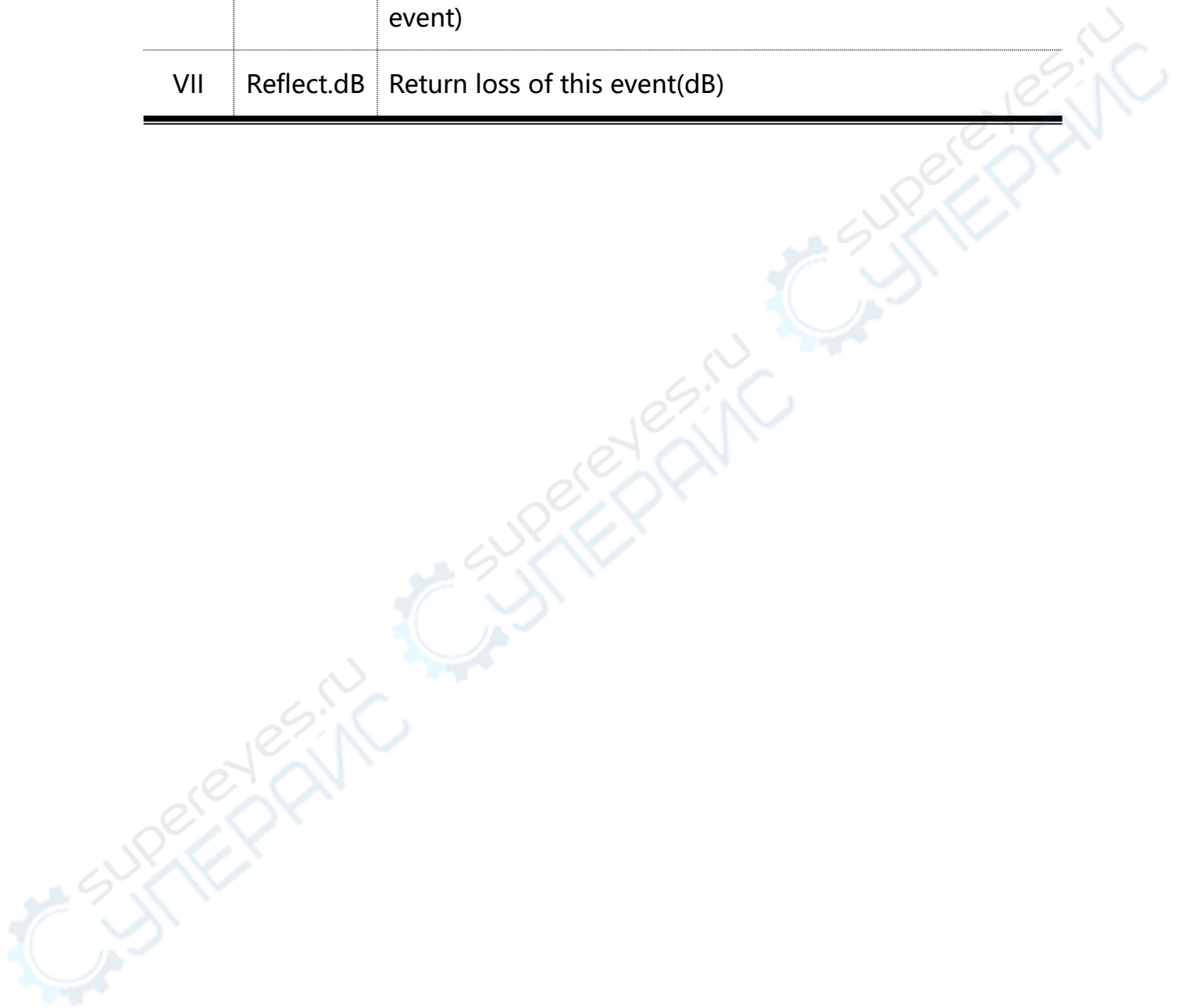

4.4 Distance Measurement

Measure the distance from one point to another.

Procedure :

1. Press **【F1】** button to active cursor function.
2. control **【◀】**、**【▶】** to move cursor A or B.
【◀◀】: move left **【▶▶】**: move right
3. Get information by following the guide below:

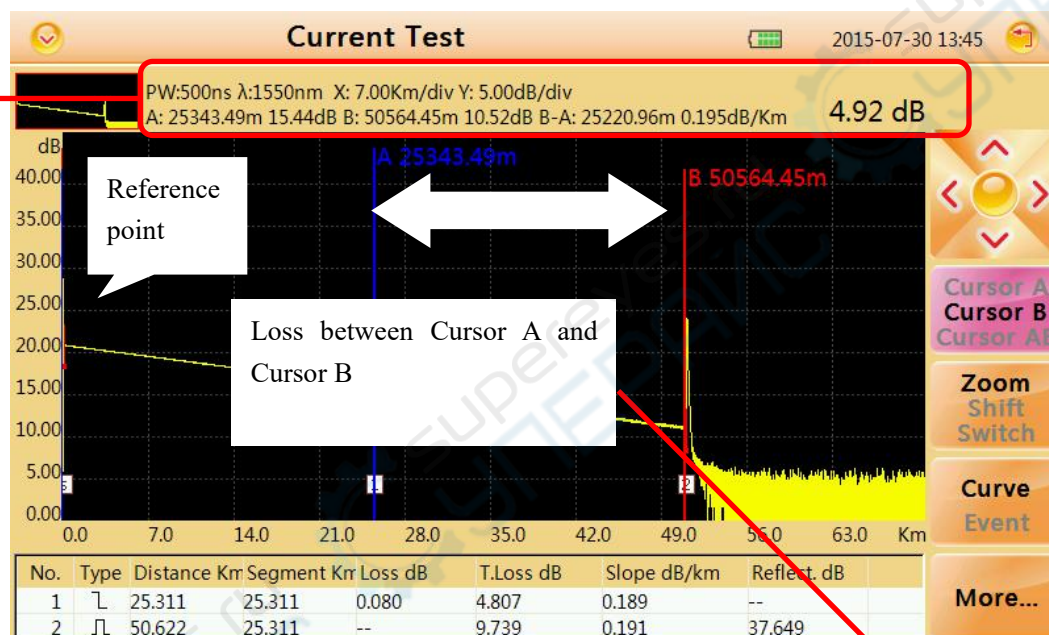

current pulse width and wavelength

Resolution of X axis and Y axis

PW:500ns λ:1550nm X: 7.00Km/div Y: 5.00dB/div

A: 25343.49m 15.44dB B: 50564.45m 10.52dB B-A: 25220.96m 0.195dB/Km

4.92 dB

Indicate distance of cursor A and cursor B which relative to the reference point(start event), relative distance(km) and loss(dB) between cursor A and cursor B.

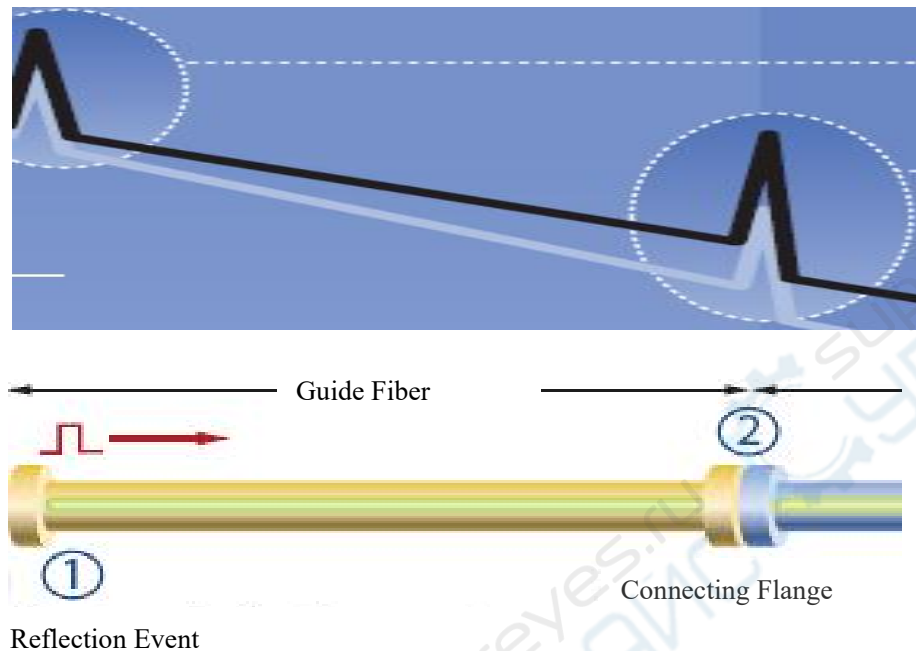

1. Guide fiber

Use an guide fiber to figure out the character of connector. By adding this fiber we could move the first connector out of the blind area. In the same way we could use this way to figure out the character of last connector.

2. About guide fiber

Proper length of Guide fiber is 100~1000m, it depends on the blind area of OTDR. In theory, minimum length of guide fiber should be two times longer than attenuation blind area , but it should be longer in practice.

At the first time using OTDR, if user choose some testing parameter which is not suitable to the real condition may cause the bad result. User should take Testing range,pulse width and wavelength into consideration.

Setting proper testing range

Testing range means maximum display range.This parameter will indicate how long will OTDR display on its screen.this range must longer than testing fiber,Usually we choose range which is 20% longer than testing fiber.Take note that testing range should not has large difference with testing fiber,Otherwise it will affect the effective resolution and overlarge testing range will result in the generation of huge and useless data(see Figure 1).

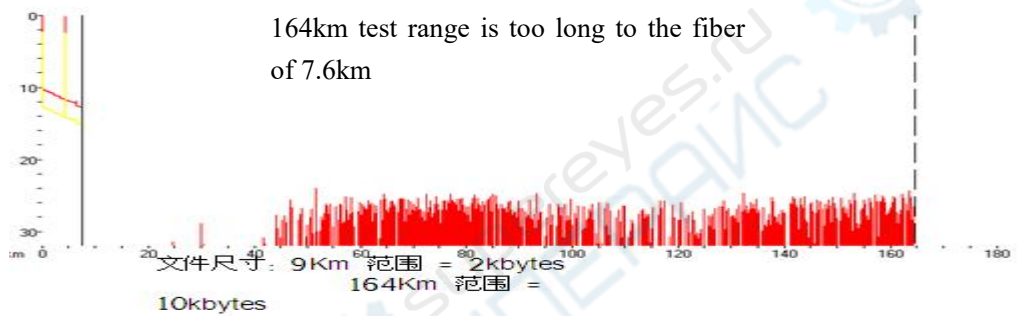

Figure 1

Setting proper pulse width

Pulse width and blind area, dynamic range are directly related to the maximum length ,in below picture, use ten different pulse width to test one testing fiber.the smallest pulse width result in the smallest blind area and the most terrible noise. The longest pulse width result in the smoothest curve and almost 1km blind area(see Figure 2).

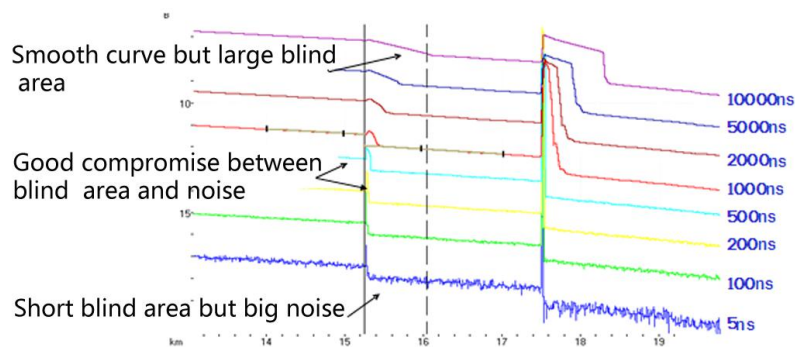

Figure 2

It is obviously at the top of testing fiber influence on Pulse width , in below chart,we cant detect the first connecting point locate in the 540m by large pulse width.(see Figure 3)

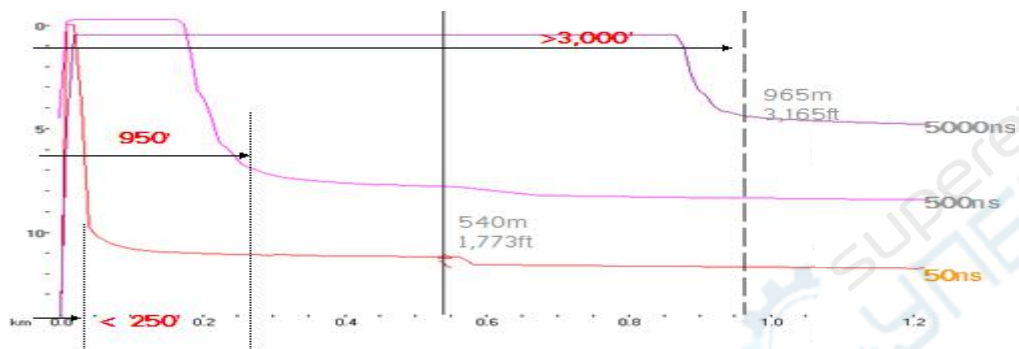

Figure 3

Dynamic range decided by Pulse width, larger pulse width will spend more optical power, but it reach further.(see Figure 4)

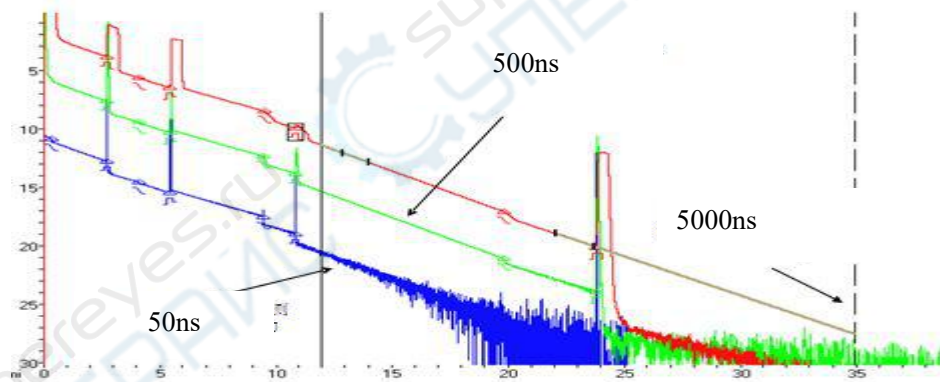

Figure 4

Setting proper wavelength

Proceed test with same fiber but different wavelength we will get different result. Longer the testing wavelength is, more sensitive of the bending, in below chart ,first splicing point has bending problem, splicing loss value under 1550nm is bigger than that under 1310nm. the other points are similar with 1310nm and 1550nm. This phenomenon indicate that this fiber is just bended at the first point. If it's possible please always compare the point state under 1310nm and 1550nm and judge whether it's bended or squashed.(see Figure 5)

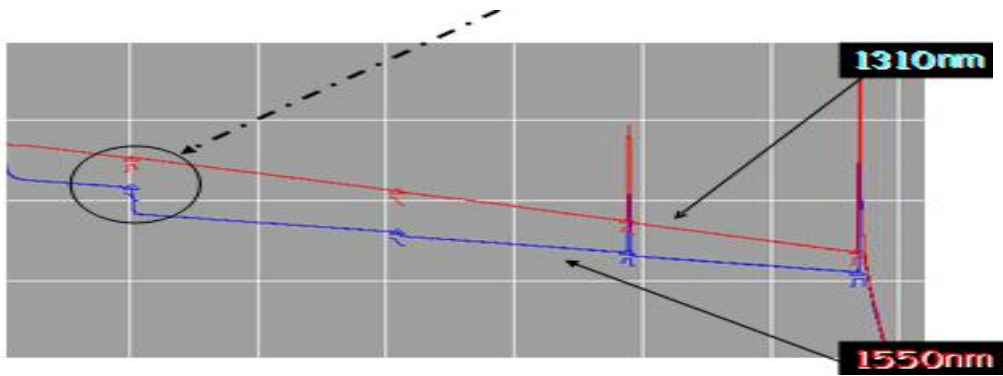

Figure 5

Set proper test time

In averaging mode, long testing time could reduce noise during the data sampling and Improve precision to get better and smoother curve(see Figure 6).

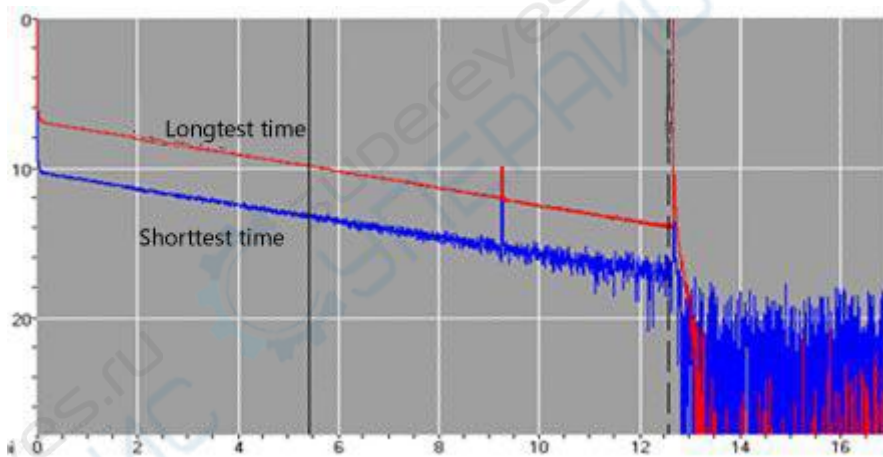

Figure 6

5.0 Expanding the Waveform and Moving the Display Area

Area

5.1 Switching between Event List and Display Window

In "current test" interface, press **[F4]** button to switch between "Curve" and "Event", expand each section after switch, this function could also switch between cursor ("Curve") and selection tag ("Event").

Procedure:

In test interface,

1. Press **[F3]** button to switch from curve to event windows
2. Control **[▶]**、**[◀]** or **[▲]**、**[▼]** button to move selection tag.

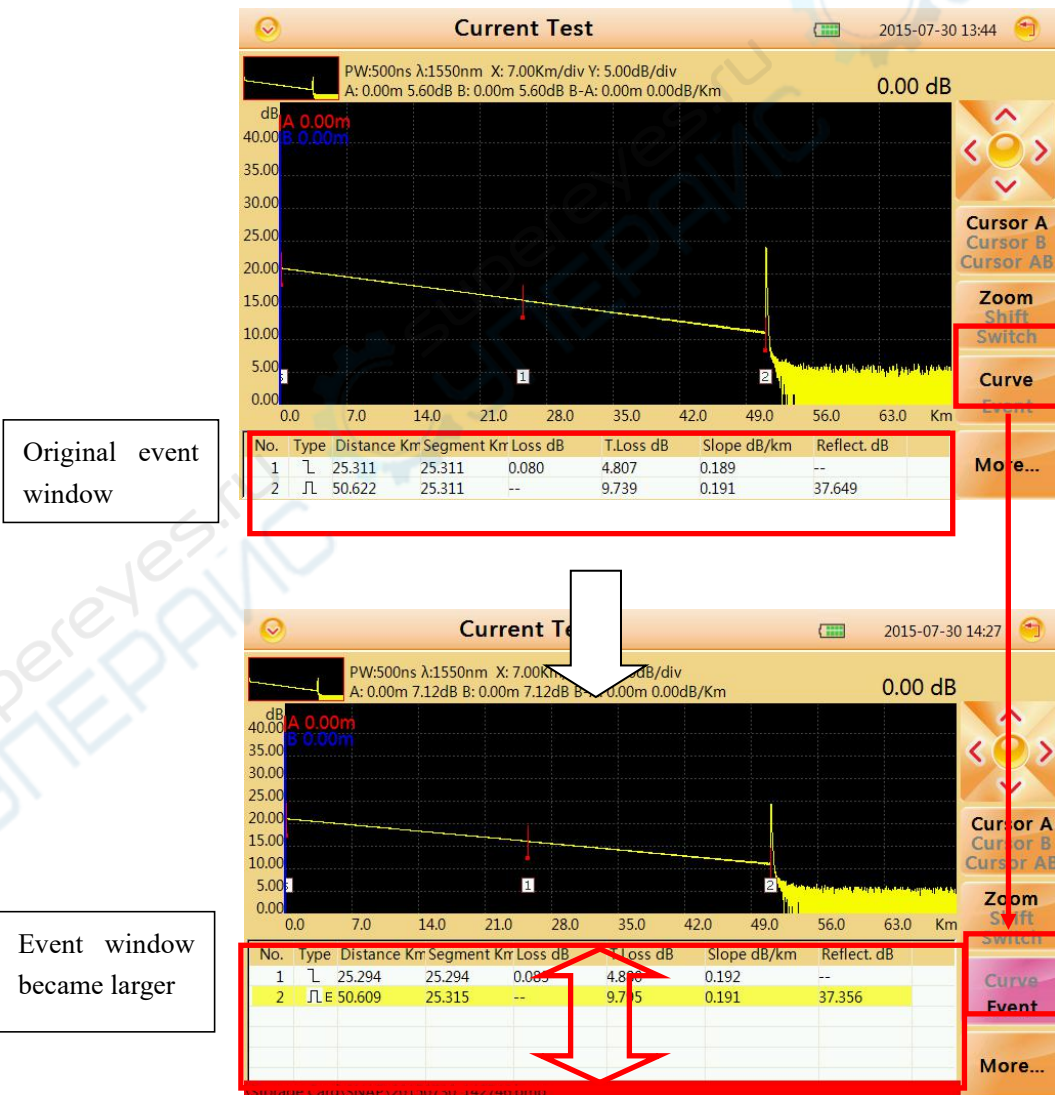

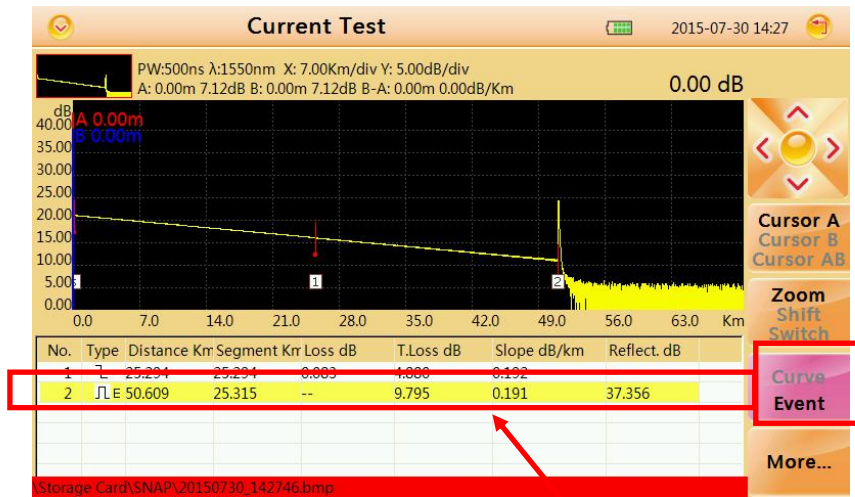

Switch to "Event",
move selection tag to
choose event.

Every time move selection bar to an event in event list, cursor will move synchronously to relevant event on curve. User could use "Zoom", "Move", "Switch" function to adjust curve to a better position, for more information please read next sections.

The chart below describe the items in event list:

Num.	Item	Description
I	Type	Type of event (attenuation event, Reflection event or end event)
II	Distance	The distance from start event to this event (Km).
III	Segment	The distance from this event to last event (Km)
IV	Loss	Loss of this event (dB)
V	T.Loss	The loss from start point to this event (dB).
VI	Slope	Ratio of loss (from last event to this event) to distance (from last event to this event)
VII	Reflect	Return loss of this event

5.2 Cursor Operation

5.2.1 Activating Cursor

In "Current Test" interface, press **【F1】** button, "cursor" tag turns yellow, means it has been activated.

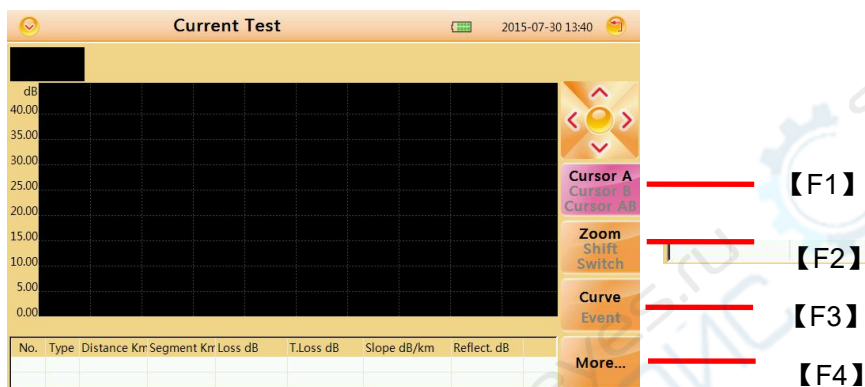

5.2.2 Moving Cursor

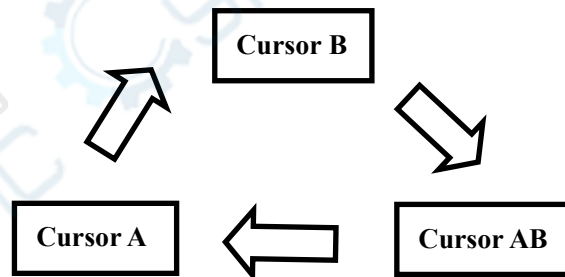

Sequence of cursor switching

Set proper cursor, press **【◀】**、**【▶】** button to move current cursor, long press to move cursor faster.

5.3 Curve Operation

5.3.1 Horizontal Zoom

Procedure:

In "Current Test" interface,

1. Press **【F1】** button to activate "Zoom" function.
2. Control **【▶】**、**【◀】** button to zoom in or zoom out curve.
【▶】: Zoom in curve **【◀】**: Zoom out curve
3. Press **【OK】** button to reset curve

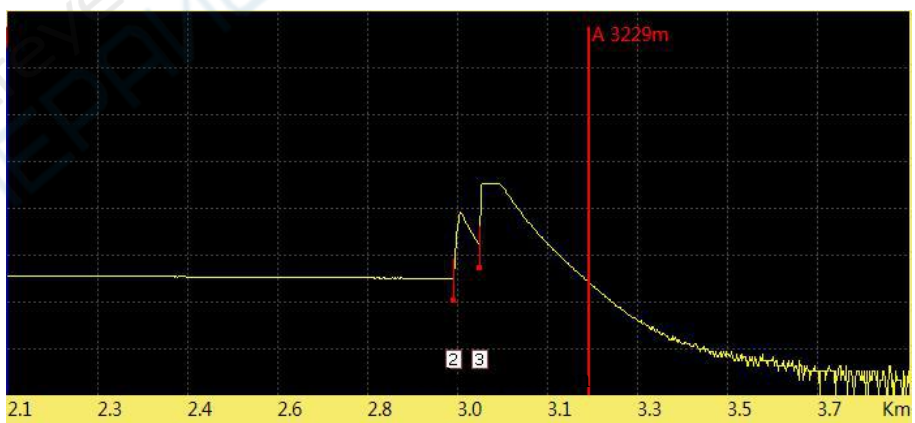
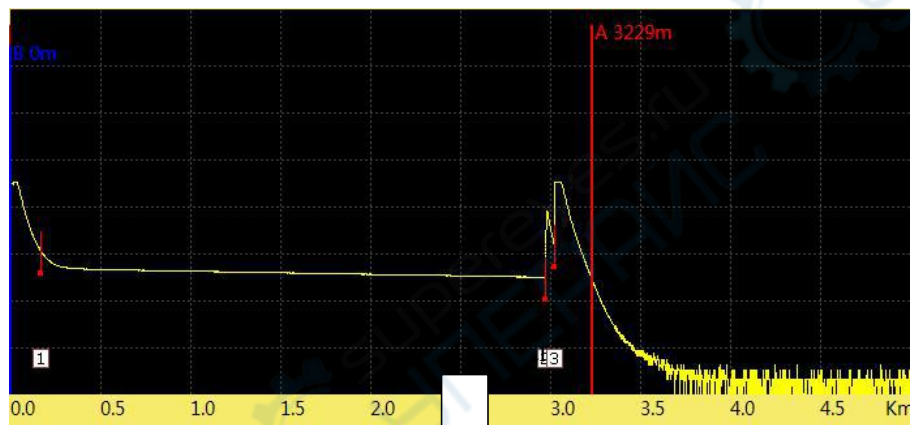

5.3.2

Vertical Zoom

Procedure:

In "Current Test" interface,

1. Press **【F2】** button, activate "Zoom" function.

2. Control **【▶】**、**【◀】** button to zoom in or zoom out curve.

【▶】: zoom out **【◀】**: zoom in

2. Press **【OK】** button to reset curve.

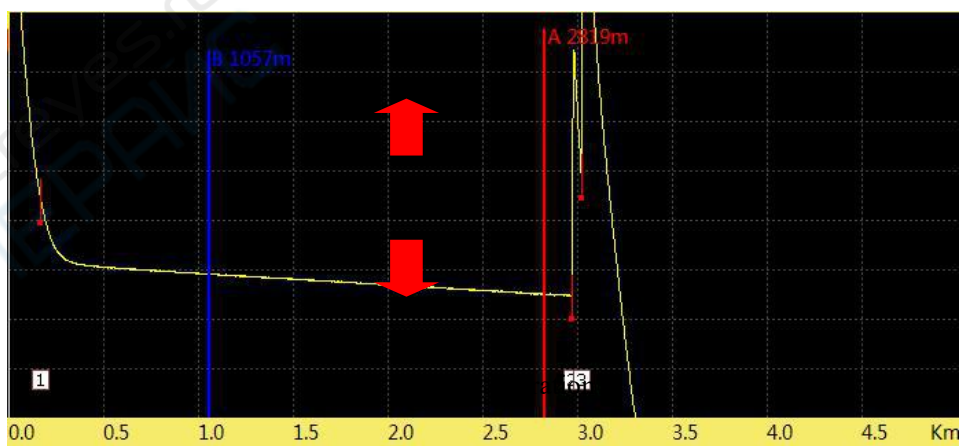
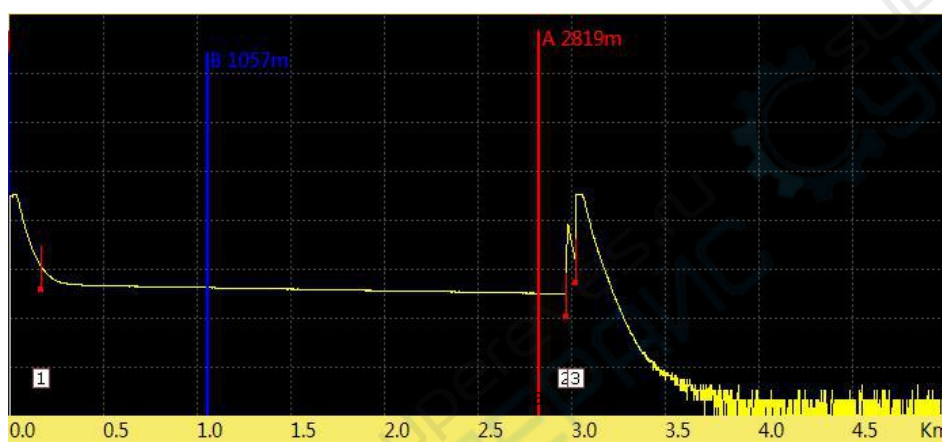

5.3.3

Horizontal Shift

Procedure:

In "Current Test" interface,

1. press **【F2】** button, activate "shift" function.
2. Control **【▶】**、**【◀】** button to move right or left.
【▶】: move right **【◀】**: move left
3. Press **【OK】** button to reset curve.



original

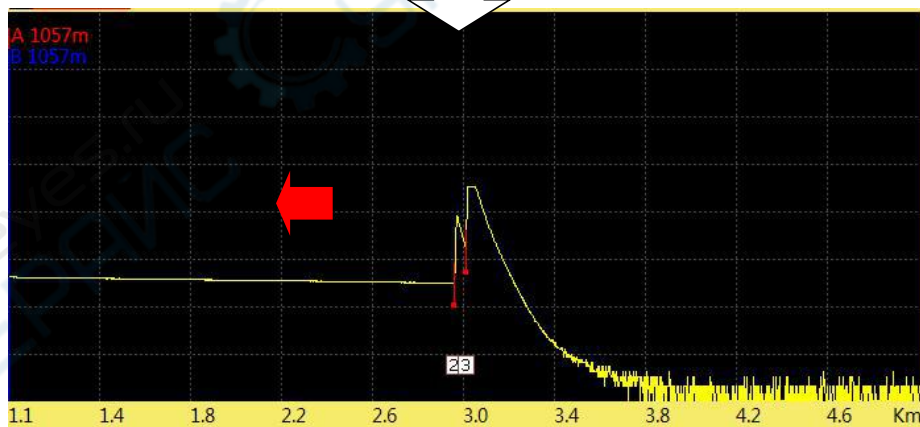

After operation

5.3.4

Vertical Shift

Procedure :

In "Current Test"interface,

1. Press **【F2】** to activate "shift"function.
2. Control **【▲】**、**【▼】** button to move up or down.

【▲】 :move up、**【▼】** :move down

3. Press **【OK】** button to reset curve.

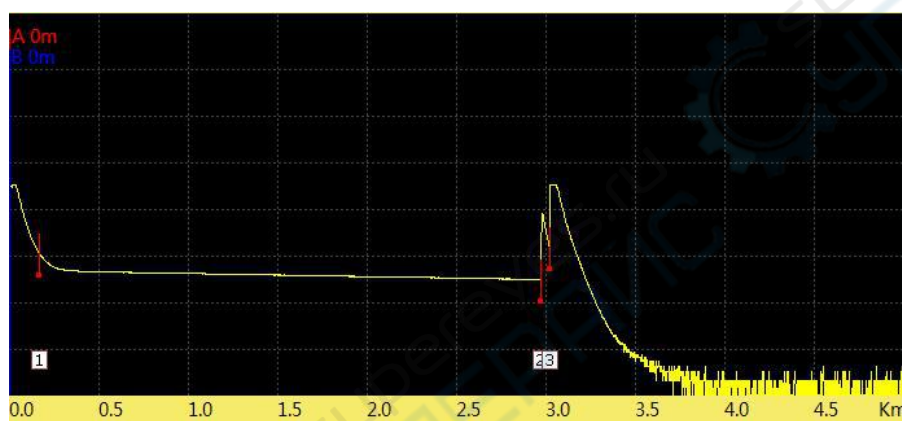

Original

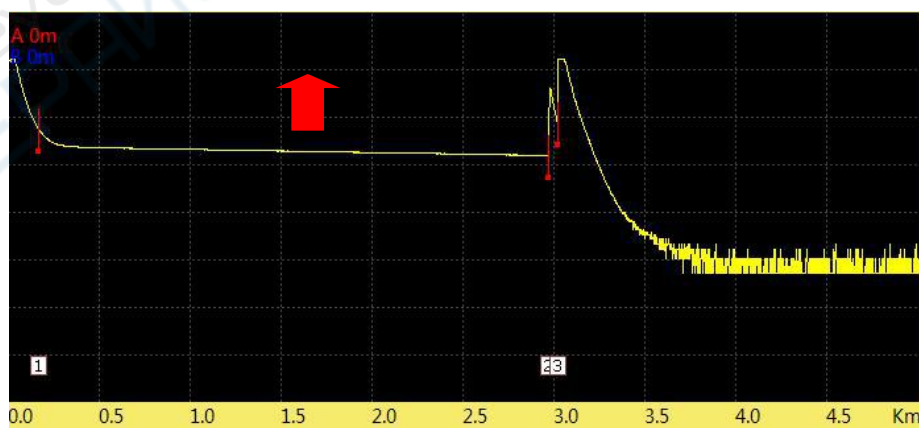
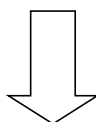

After operation

5.4 Elaborating Event

This section we will introduce how to elaborate an event on curve, example as event 2 in below curve.

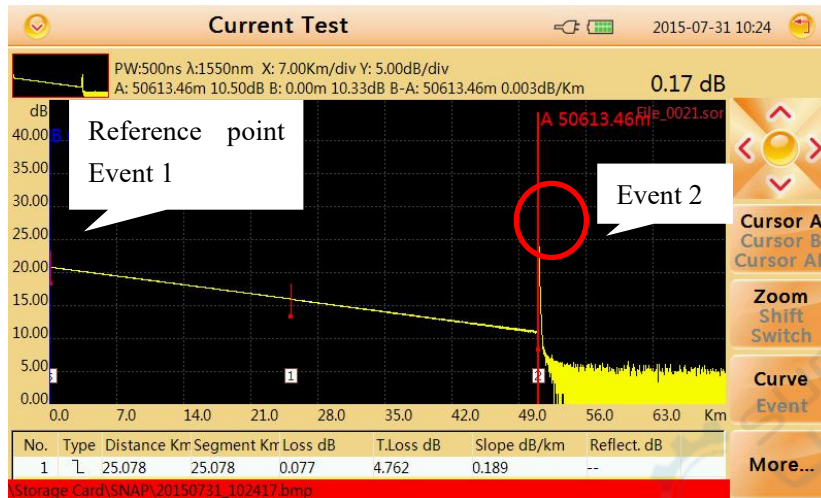

Procedure :

In "Current Test" interface,

1. Press **【F1】** button to activate cursor function.
2. control **【◀】**、**【▶】** to move cursor(A or B) left or right.
3. Move to event 2.
4. Press **【F2】** button to active Zoom function.
5. Control **【▶】** button to zoom out event(cursor as the center).
6. Press **【F2】** button to activate"shift" function.
7. Control**【▲】**、**【▼】**、**【◀】**、**【▶】**button to adjust to a proper position.



5.5 Switching between Curves

This function could be used to switch between several curves, current curve displayed in yellow.

Procedure :

In "Current Test" interface,

1. Press **【F2】** button, active "switch" function.
2. Control **【▲】**、**【▼】** button to switch between curves.
【▲】: switch to above curve **【▼】**: switch to below curve
3. Press **【OK】** button to reset all curves.

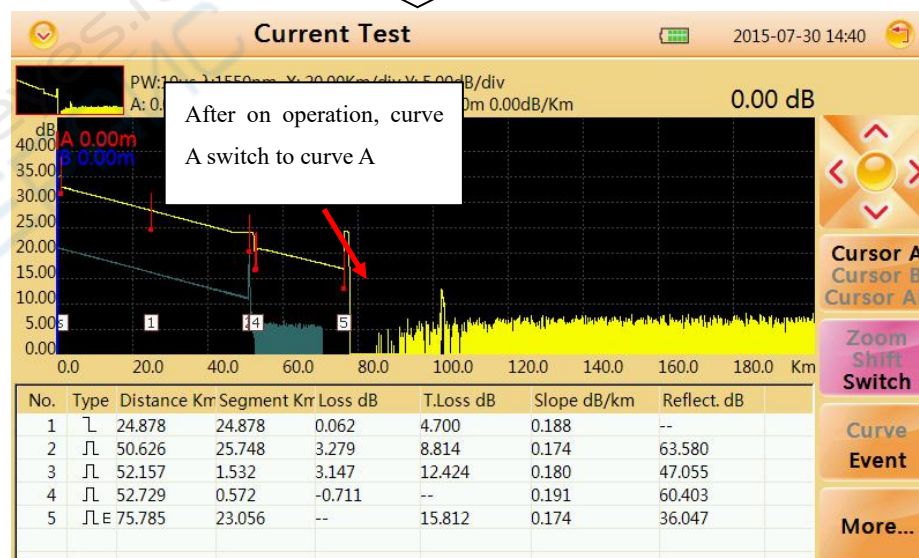
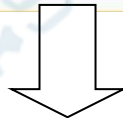
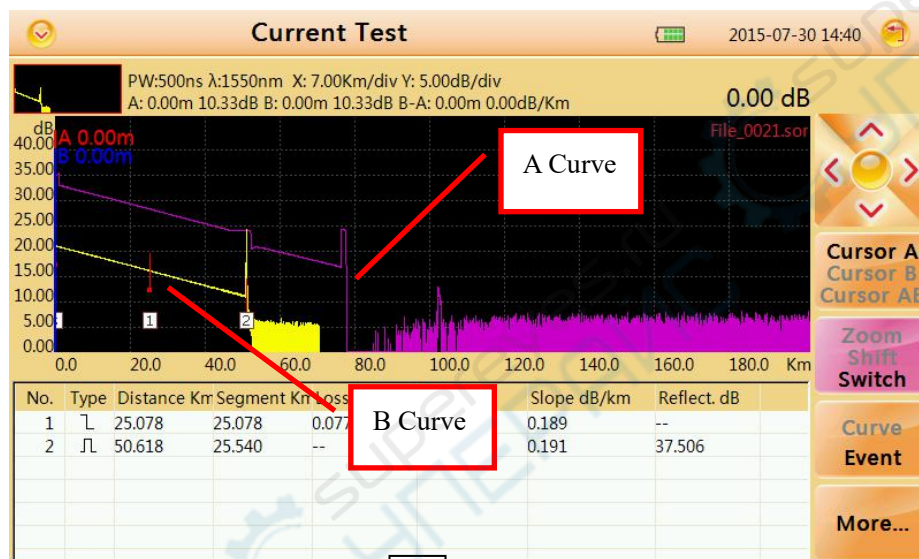

Caution

Display maximum 8 curves at one time, if load more than 8 curves, last curve will recover the former one, please refer 6.2 "Load Curve" for learning how to load curve(s).

5.5.1 Removing Curve(s)

User could remove one or several curves.

Press **【F4】** "More..."tag menu:

- **Remove Current Trace** Remove the Curve which has been selected.
- **Remove Other Trace** Remove the Curve(s) which has not been selected.
- **Remove All** Remove all the Curves.

5.6 Removing an Event

Procedure:

In current Test interface,

1. Press **【F1】** button to activate tag , move cursor to the target event.

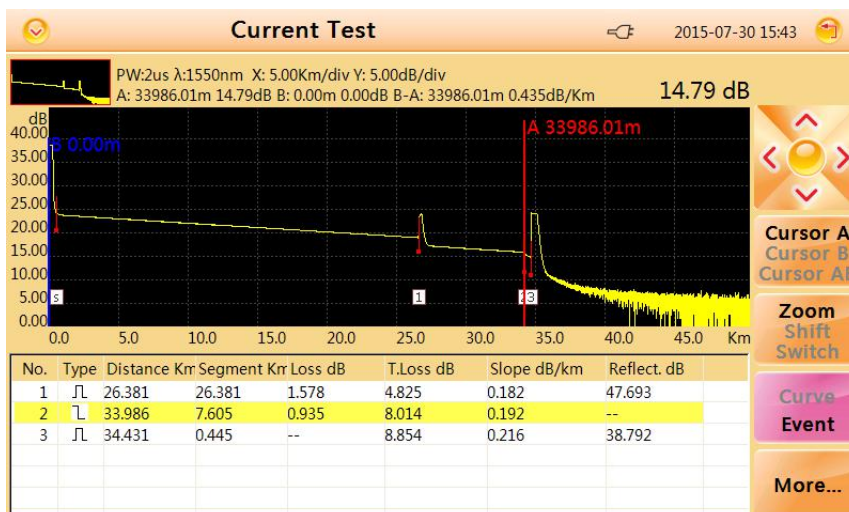

2. Press **【F4】** button to select "More..."tag

3. Press **【F2】** "Remove Event"tag to remove event.

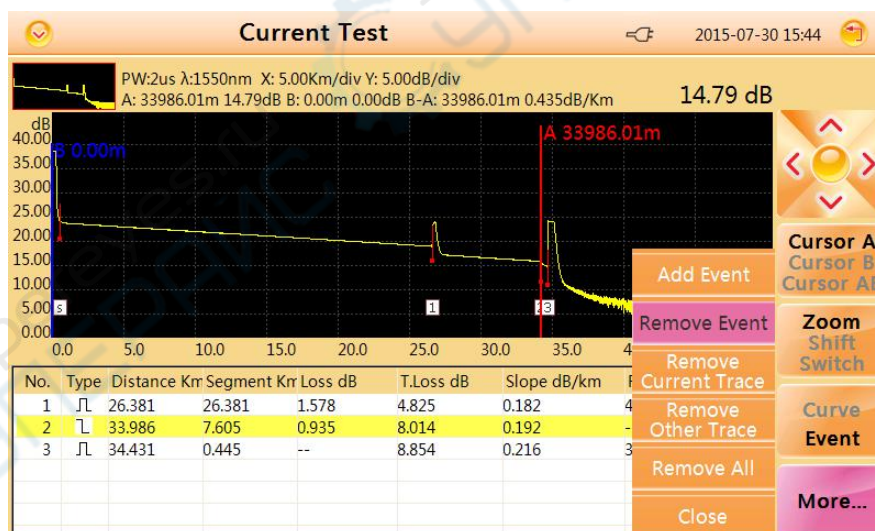

5.7

Adding an Event

Procedures:

In current Test interface,

1. Press **[F1]** to activate cursor function move to target event.

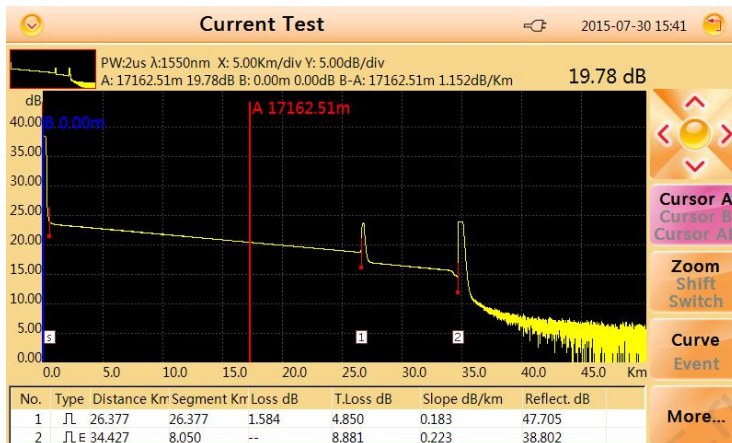

2. Press **[F4]** button to select "More..." tag
3. Press **[F3]** to add event.

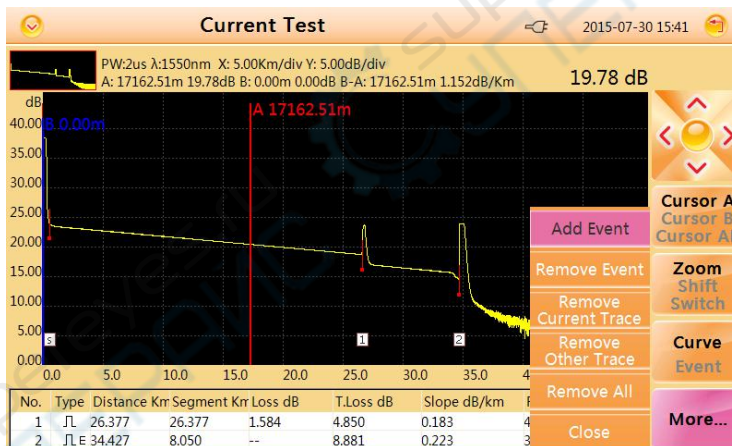

Caution

Event addition may not operate successfully for too close to another event, user could move cursor a bit away from near event and have another try.

6.0

File Operation

In "Current Test" interface Save the current curve ,press **【FILE】** button on the board ,open "File Operation"interface,showed as follow:

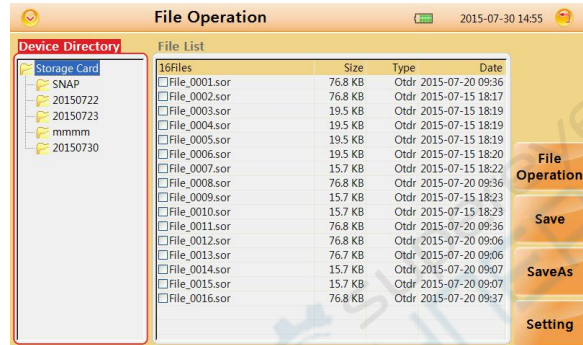

"File Operation" interface

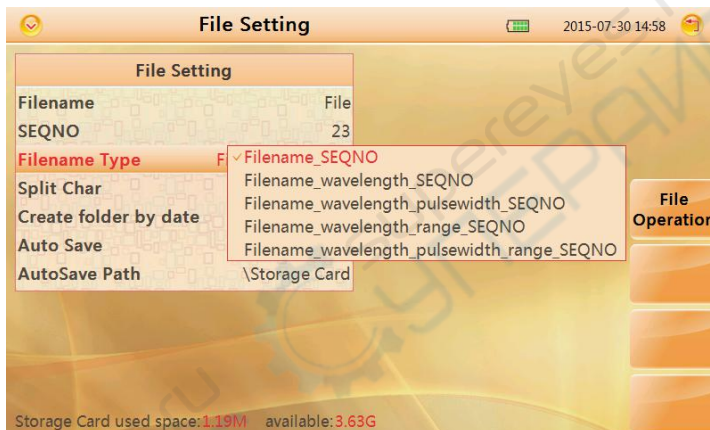

File Setting



6.1

Saving Curve

Procedure:

In "Device Directory" window,

1. press **【▲】**、**【▼】** to choose file and subfile then press **【OK】** .
2. Press **【F1】** button to enter "File Operation"interface ,user can change way of saving,decide way of naming and check memory state.
3. Press **【F2】** "Save" tag to save current curve as default name(set in "Filename Type"under "File Setting"interface).
4. If user want to change a name before saving , press **【F3】** "Save As"tag to input your ideal name(refer section7.0"Entering Characters" to learn how to

input characters) and confirm by **【OK】** button.

6.2 Loading Curve(s)

Procedure:

In "Device Directory" window,

1. Press **【▲】**、**【▼】** to choose relative file and subfile press **【OK】** .
2. Press **【▶】** switch to "File list" window.
3. Control **【▲】**、**【▼】** button to to select relevant file curve file(s),press **【OK】** button to select the relevant file(s).
4. Press **【F1】** , select "Load" tag to load curve(s).

6.3 Deleting Curve(s)

Procedure:

In "File Operation" interface,

1. Select the curve file(s) which you want to remove.
2. press **【F1】** "file operation" select "delete" sub menu to delete curve file(s).

6.4 Copying/Moving Curve(s)

Procedure:

In "File Operation" interface,

1. Select the curve file which you want to remove.
2. Press **【F1】** "File operation" select "Cut" or "Copy".to move or copy curve file(s).
3. Choose the target folder, press **【F1】** "File Operation".
4. Select "Paste" tag to finish this operation.

6.5 File Setting

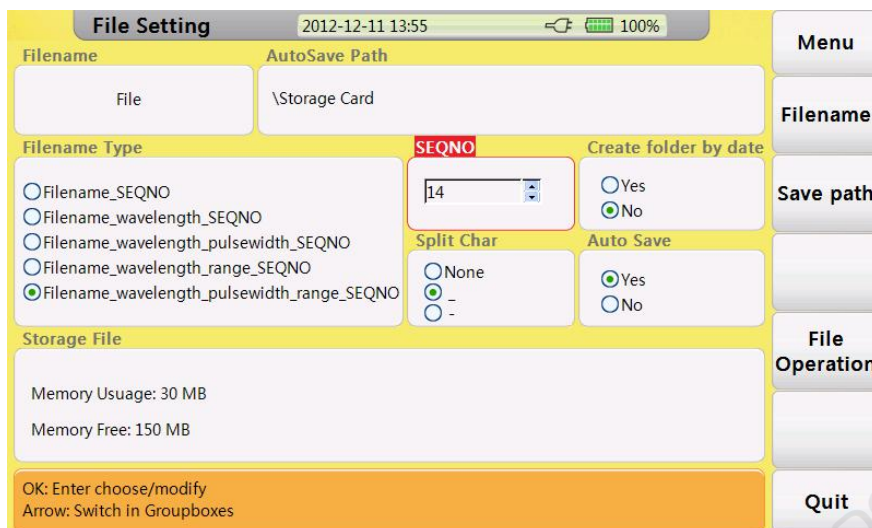

"File Setting " interface

Tags:

Item	Description
Menu	Back to main menu
Filename	Modify prefix of file name
Save Path	Modify the save path of files
File Operation	Back to "File Operation" interface
Quit	Quit current interface

Items:

Item	Description
Filename	Prefix of file name , modify by "Filename"tag menu
AutoSave Path	Save path of auto save
Filename Type	Naming way of files after auto save
SEQNO	Sequence number of next test,and auto increment

	after each test
Create folder by date	Set create folder by today's date and save files separately into them
Split char	Set the type of separator
Auto save	Set Auto save

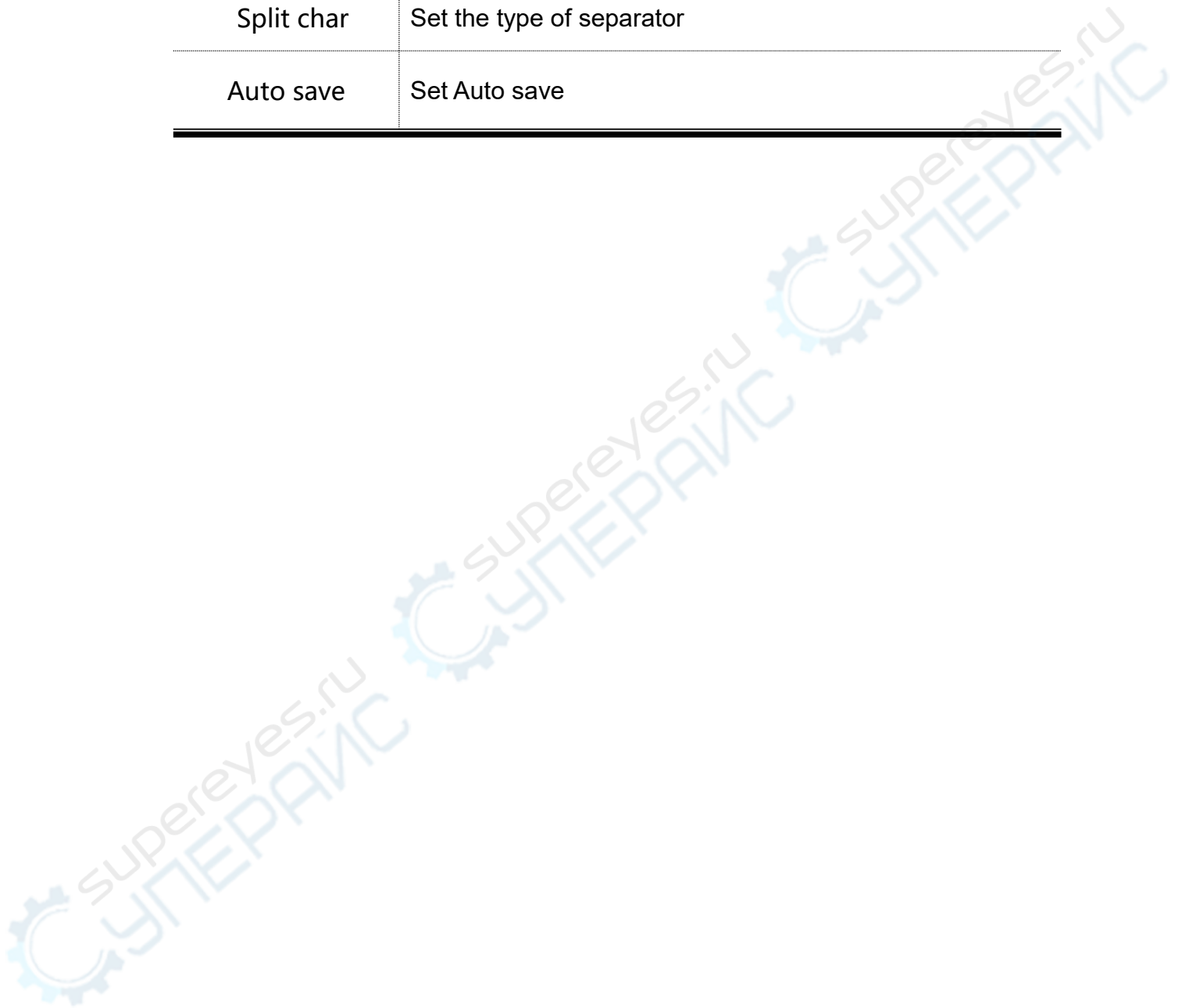

6.6 Print Screen

MINI OTDR could capture current screen and save as ".BMP"format file.

Procedure:

Press  button to capture.

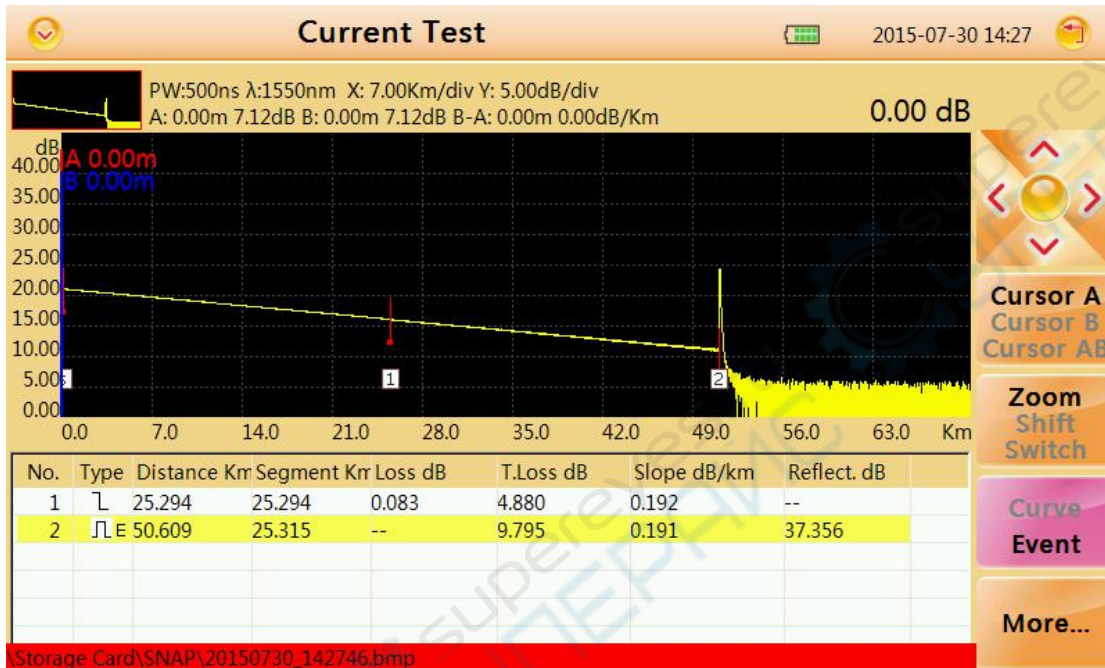

Save Path

User could check captured screen in "File Operation"by pushing **FILE** button.

Caution

User could change save path under "File Setting".

7.0

Entering Characters

You can enter file names and comments from the character input screen shown below when saving the measured waveforms.

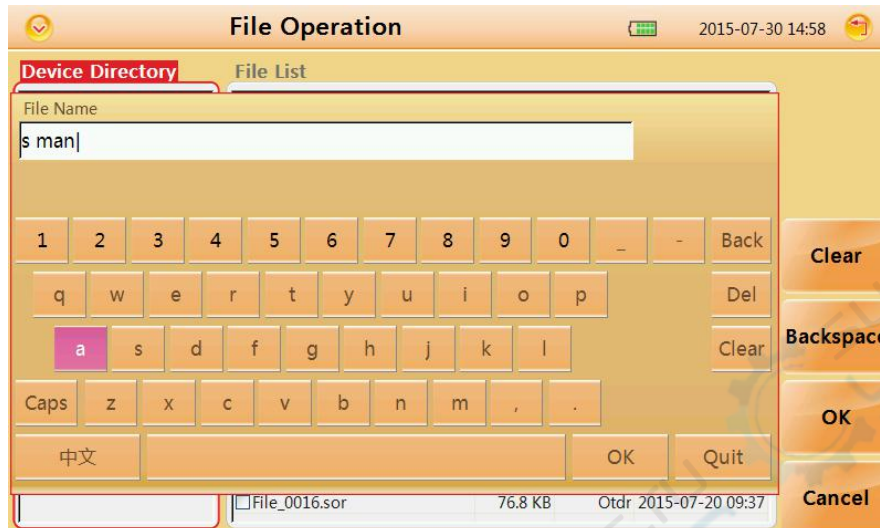

7.1 Renaming

Next guide will teach you how to change the name of file:

Procedure :

In "File Operation" interface

1. Select your target file
2. Press **【F1】** "File Operation", select "Rename"
3. Input name
4. confirm by "OK"

7.2 Creating Directory

Before create a folder system will inquire you to input a name:

Procedure :

In "File Operation" interface

4. Select your target folder or root directory
5. Press **【F1】** "File Operation", select "Create Directory"
6. Input name and confirm by "OK" on visual keyboard

8.0 FLM Test

FLM Test (Fiber Link Measurement), also known as "Optical Eye", uses multiple pulse width acquisitions and advanced algorithms to quickly characterize the fiber under test and display the optical events applying intuitive symbols.

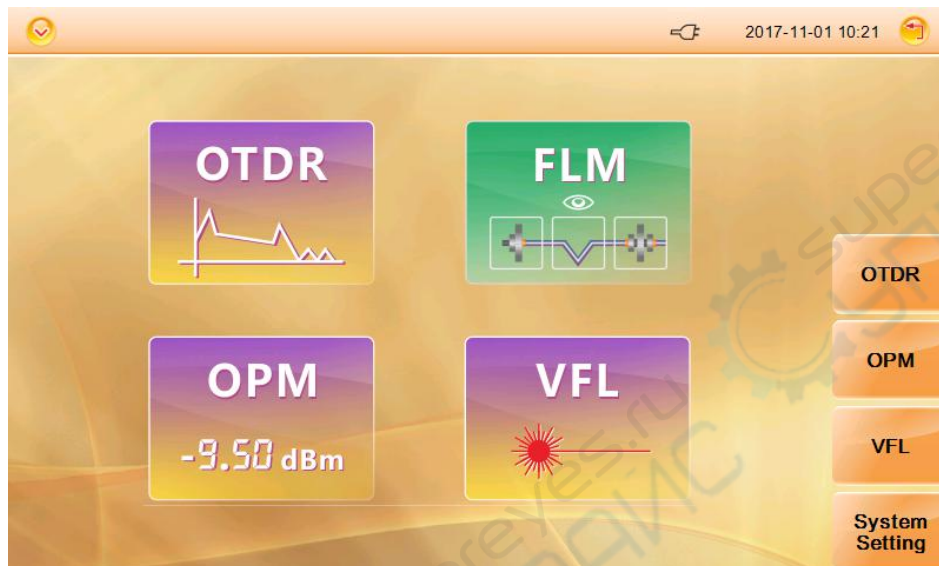

Select "FLM" module and press **【OK】** to enter FLM interface as below:

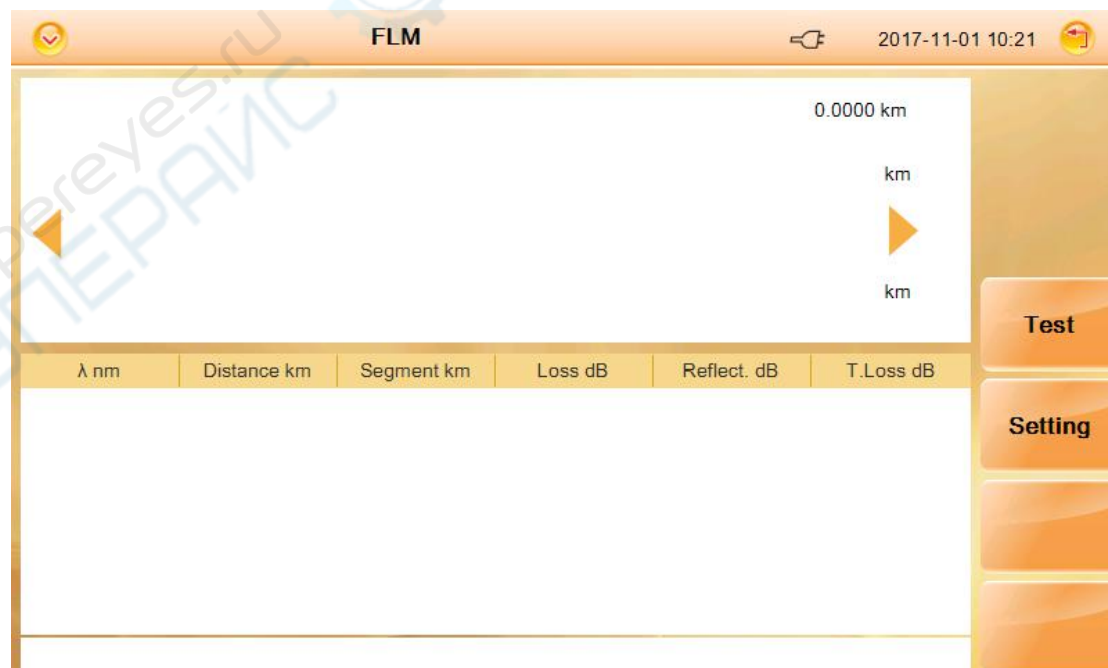

Press **【F2】** "Setting" to enter the setup interface.

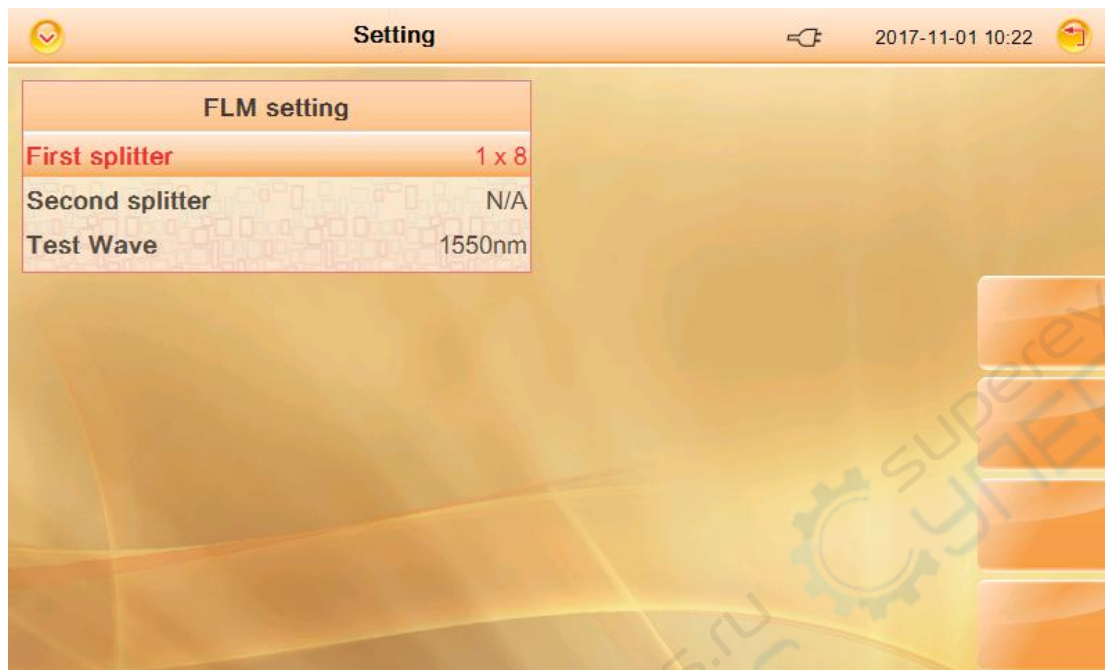

Press **【▲】** or **【▼】** to set "First splitter", "Second splitter" or "Test wavelength" option according to the actual condition of your fiber under test.

After setup is finished, press **【ESC】** back to test interface and press **【F1】** to start the FLM test.

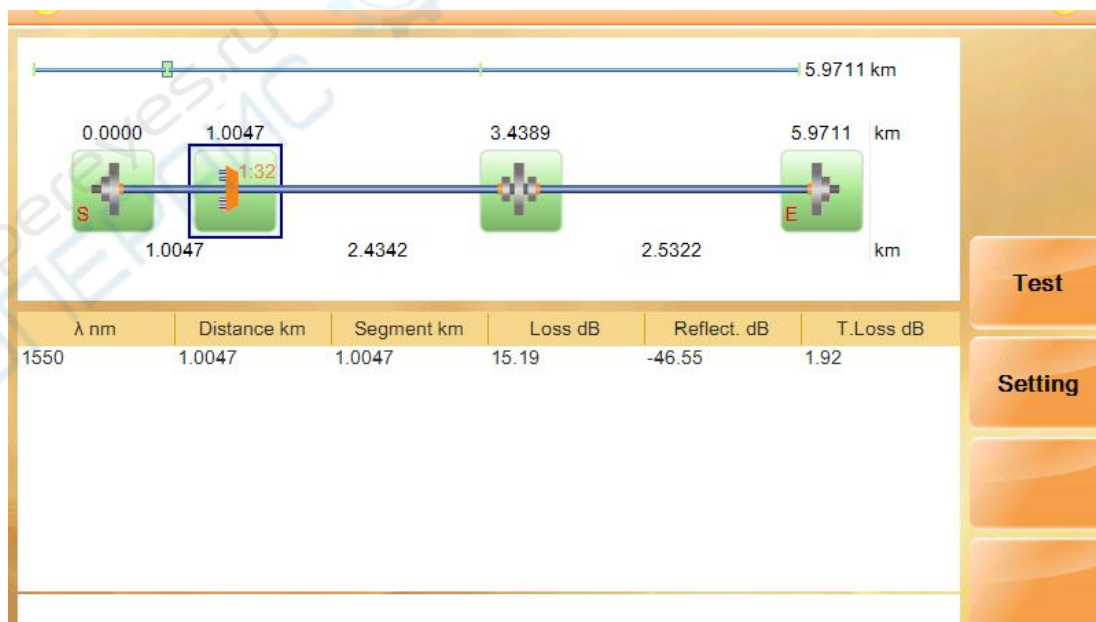

Press **【◀】** or **【▶】** to check detailed information of each event.

9.0 VFL(Visual Fault Locator) Module

MINI OTDR equipped with VFL module(650nm) to simply detect broken point of optical network

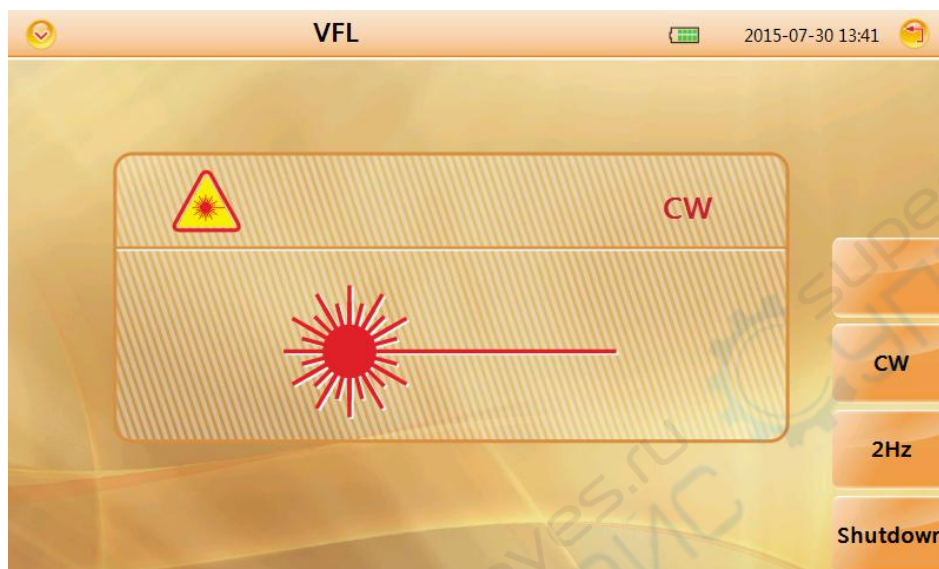

VFL interface

VFL module has two modes:

CW

Launching continuous wave (650nm)

2Hz

Launching 2Hz modulated wave (650nm)

Press "Quit" to quit VFL interface



Warning

Don't direct the optical port to human eyes !

10.0 Optical Power Meter Module (Optional)

OPM Module is used to quick get the power of terminal port.at site

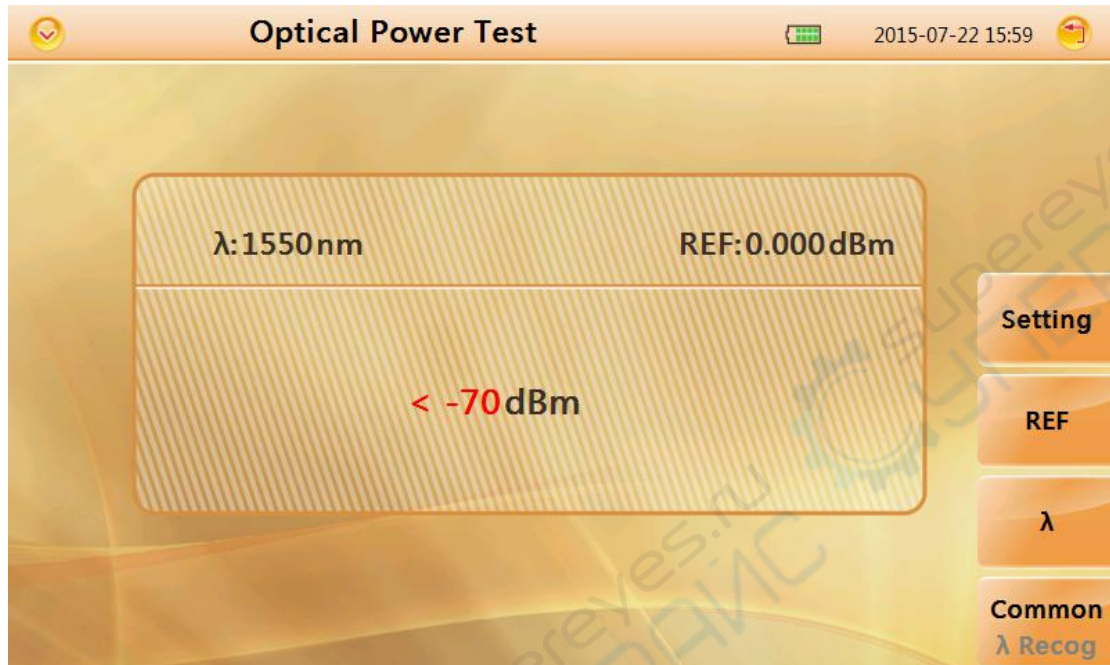

OPM interface

Setting

Set offset value and display precision

REF

Press "REF" to set current power value as reference value

λ

Switch wavelength

Common/ λ Recog

switch between common mode and wavelength detection mode

✘ Wavelength will not change automatically in common mode

11.0 Software Update

MINI OTDR could proceed update by one U disk(with patch storage in root directory).

Procedure:

1. Download patch from PC and storage into U disk(✗ **must storage in root directory**).
2. Insert U disk into USB port.
3. Turn on MINI OTDR, press **【F5】** to enter system setting,press **【F2】** to proceed upgrades.



Upgrades interface1

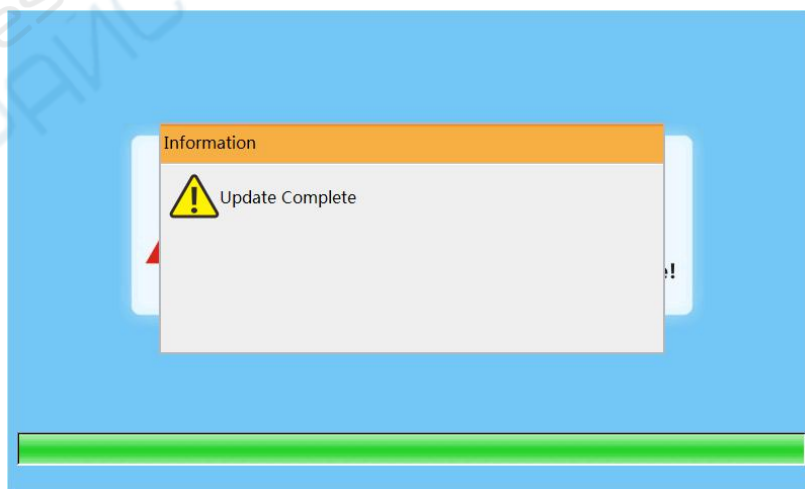

Upgrades interface2

12.0 Background Information on Measurements

12.1 Viewing the Optical Pulse Measurement Waveform

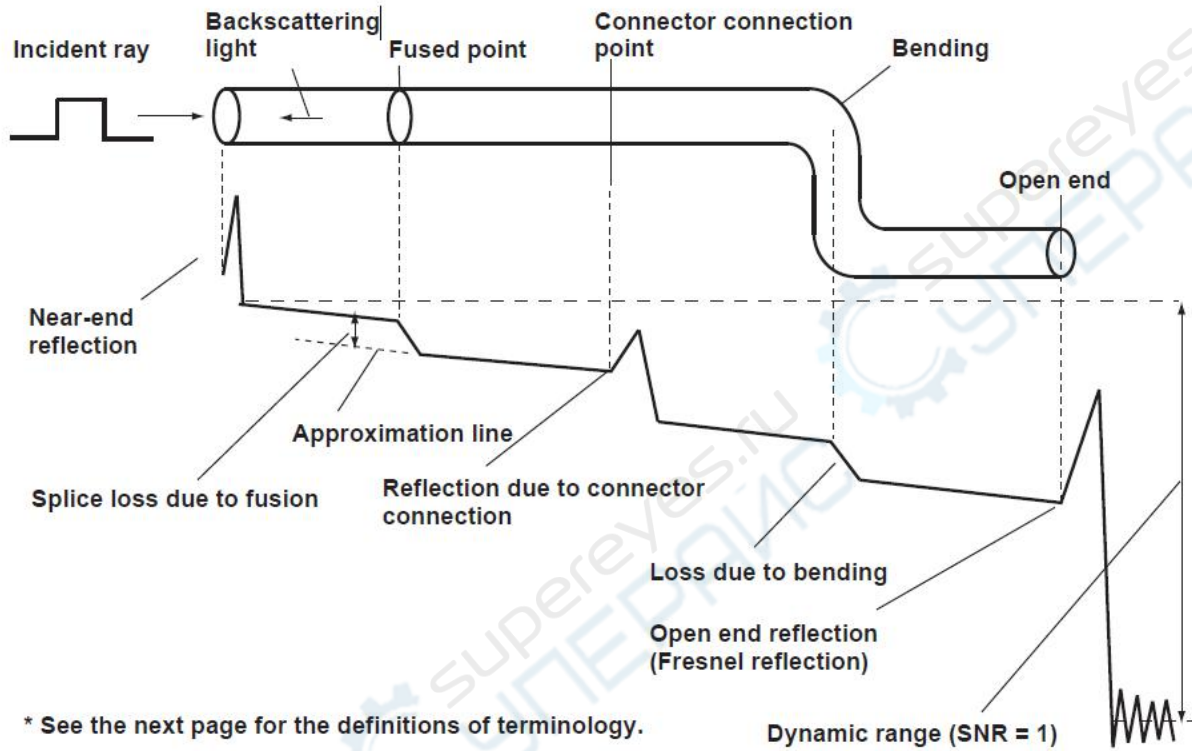

Near-end reflection

A reflection occurs in the gap between the OTDR and the connector for the optical fiber cable. Losses and reflections of the connection points cannot be detected in the section in which this reflection is detected. This section is called a dead zone.

Backscattering light

When light propagates through the optical fiber cable, a phenomenon called Rayleigh Scattering occurs due to the nonuniformity of the density or constituents of materials smaller than the wavelength unit. The scattered light that is transmitted opposite to the direction of propagation is called backscattering light.

Splice loss due to fusion

A splice loss occurs at the fused section mainly due to axis offset and angle offset.

Reflection due to connector connection

Unlike the fused section, a slight gap occurs in the connection section of connectors. Because the group refraction index changes in this gap, a reflection occurs causing a loss.

Fresnel reflection at the far end of the optical fiber cable

Fresnel reflection occurs at the location where the optical fiber cable is broken or a location where the group refraction index changes such as the far end of the cable (glass and air) when light enters the cable. If the end face of the optical fiber cable is vertical, approximately 3.4 % (−14.7 dB) of the incident light power is reflected.

Dynamic range

Dynamic range refers to the difference between the backscattering light level at the near end and the noise (RMS = 1).

Dead zone

The locations where measurements cannot be made due to the effects of Fresnel reflection, connection point of connectors, etc.

13.0 Maintenance

13.1 Notice

MINI OTDR Use rechargeable Li-ion battery.

Pay attention to the following :

- Keep OTDR dry and clean store at room temperature(15°C~30°C).
- Charge it monthly if you don't use it for a long time(more than one month).
- keep Optical port clean by alcohol soaked cotton and recover dust cap after use..
- Clean optical port and connector at fixed period .

Follow the principles below before cleaning:

- Shut off before cleaning.
- Any operations contrary to the instructions may result in dangerous laser injuries.
- Disable laser launching before cleaning.
- When the instrument is in operation, please always avoid looking directly into optic output. Although laser radiation is invisible, it may do serious injury to eyesight,
- Be cautious of electric shock and make sure AC power is disconnected from the instrument before cleaning. Always use dry or moist soft cloth to clean the outside of the instrument, and never touch inside.
- Don't proceed any modification on OTDR.
- For maintenance, please always operated by qualified worker.

13.2 Cleaning Tools

1. Optic fiber cleaner (for cleaning of optic connectors)
2. Optic fiber cleaning rod (for cleaning of optic outputs)
3. Optic fiber cleaning tissue (for cleaning optic interfaces)
4. Isopropyl alcohol
5. Cotton ball
6. Paper tissue
7. Cleaning brush
8. Compressed

13.3 Cleaning of Optical Port

Procedure:

1. Screw down the cap
2. Pull out ceramic core by fingers
3. Clean port carefully
4. Recover ceramic core
5. Screw on the cap

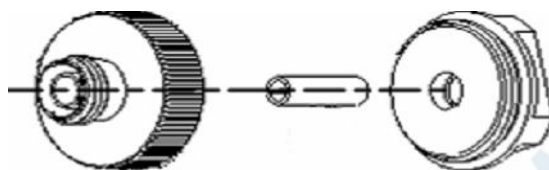

Structure of optical port

Caution

Be careful, don't use tools like plier, it may cause permanent damage to optical port

13.4 Calibration

We suggest to calibrate MINI OTDR twice a year, for more information please contact us

14.0 Diagnosis Center

14.1 FAQ

Fault	Reason	Solution
Can't turn on	<ol style="list-style-type: none"> 1.Holding time on power button is not enough(>2s). 2.Run out of power / battery has broken. 3.No battery. 4.Too cold there. 	<ol style="list-style-type: none"> 1. Long press on ON/OFF key. 2.Connect external power/ Replace a new battery. 3.Install battery. 4.Change another environment.
Display shows nearly nothing after turned on	<ol style="list-style-type: none"> 1.Brightness need to be adjusted. 2.Connection between display and motherboard is not good. 	<ol style="list-style-type: none"> 1.Adjust brightness. 2.Open and reconnect.
Battery does not work properly	<ol style="list-style-type: none"> 1.Temperature is too high. 2.Connection is not proper. 3.Battery is nearly broken. 	<ol style="list-style-type: none"> 1.Try to decrease temperature. 2.Reconnect battery. 3.Replace a new one.
Power state indicator turns yellow	Battery has broken	Replace a new one
Measuring graphic only has front end reflection	<ol style="list-style-type: none"> 1.Connector loose,polluted, damaged or unmatched. 2.Locating pin has broken. 	<ol style="list-style-type: none"> 1.Clean and reconnect. 2.Change a new adapter.
No response		Restart

Find Ghost	<p>1. Often happened in large plus width, long range and short link condition.</p> <p>2. Common ghost caused by continuous reflection of connector.</p>	<p>1. Use proper measuring range and pulse width setting.</p> <p>2. Reconnect fault point of Reflection event, reduce reflection strength.</p>
------------	---	--

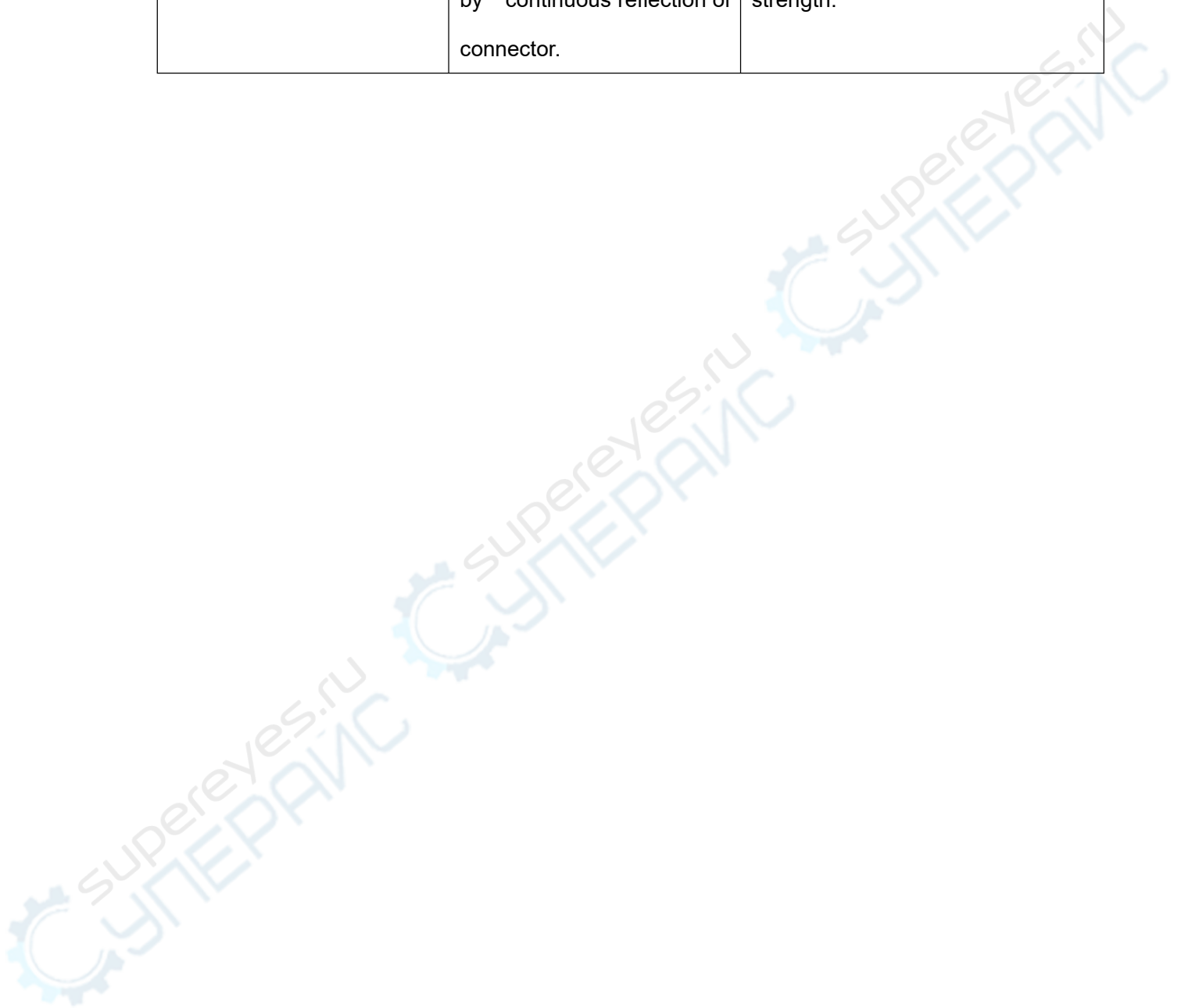

MINI OTDR has an build-in manual with essential information

Procedure :

Turn on OTDR

1.Press **【F4】** enter system setting , press **【F4】** to read manual

Control **【▲】【▼】** button to flip over

2.Press **【Esc】** to quit

15.0 Specification

15.1 Physical Parameter

Display	5 inch TFT-LCD (touch screen)
Battery	7.4V/3300mAh lithium battery (with air traffic certification) , Continuously test: 6 hours(back light off)③, Charging time: 3.5hours
Data Storage	20000 groups of curve
Interface	3×USB port (USB A Type×2, Micro-USB×1)
Working Temp	-10°C~+50°C
Storage Temp	-20°C~+70°C
Humidity	≤95%(non-condensation)
Dimension	195×140.5×46mm / 0.9kg(battery included)
Accessories	Main unit, 12V power adapter, Lithium battery, FC adapter, USB cord, User guide, CD disk, carrying case, safe belt

15.2 Test Index

Type	Testing wavelength	Dynamic range①	Event/Attenuation dead-zone②
FHO2000-D26	1310/1550nm	26/24dB	1/6m
FHO2000-D35		35/33dB	
Pulse width	3ns, 5ns, 10ns, 20ns, 50ns, 100ns, 200ns, 500ns, 1μs, 2μs, 5μs, 10μs, 20μs(only for D35)		
Testing distance	100m, 500m, 2km, 5km, 10km, 20km, 40km, 80km, 120km, 160km, 240km		
Sampling resolution	Minimum 5cm		
Sampling point	Maximum 128,000 points		
Linearity	≤0.05dB/dB		
scale indication	X axis: 4~70m/div, Y axis:0.09~5dB/div		
Loss threshold	0.01dB		
Loss resolution	0.001dB		
Distance resolution	0.01m		
Distance accuracy	±(1m+measuring distance×3×10 ⁻⁵ +sampling resolution)(excluding IOR uncertainty)		
Refractivity Setting	1.2000~1.5999, 0.0001 step		

VFL Module(Optional)

Wavelength	650nm
Power	10mw,CLASSIII B
Range	12km

Connector	FC/UPC
Launching Mode	CW/2Hz

OPM Module(Optional)

Wavelength Range	800~1700nm
Calibrated Wavelength	850/1300/1310/1490/1550/1625/1650nm
Test Range	-60~+5dBm
Resolution	0.01dB
Accuracy	$\pm 0.35\text{dB} \pm 1\text{nW}$
Modulation identification	270/1k/2k Hz, $P_i \geq -40\text{dBm}$

Notes:

1 Dynamic range is measured with maximum pulse width, averaging time is 3 minutes ,SNR=1; The level difference between the RMS noise level and the level where near end back-scattering occurs.

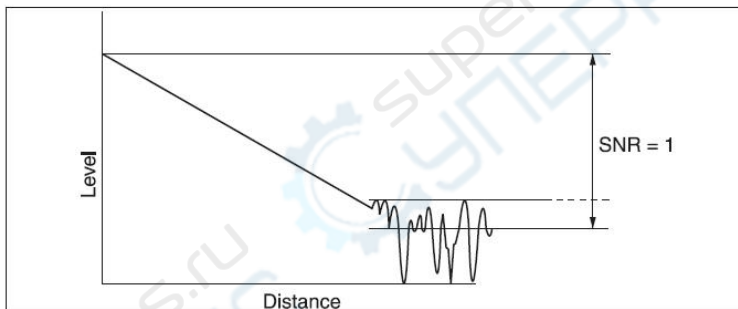

2 Event dead zone is measured with pulse width of 3ns;attenuation dead zone is measured with pulse width of 5ns.

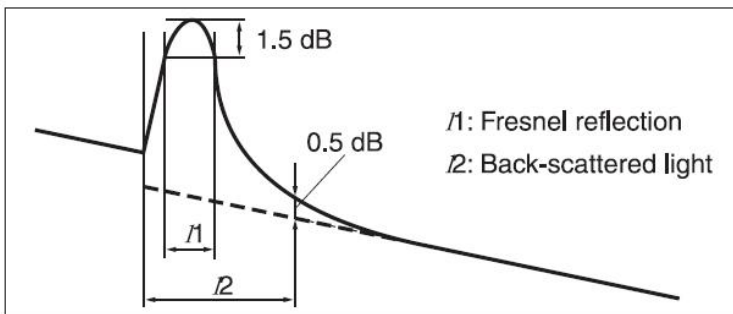

3 Typical ,back light off ,sweeping halted at 25°C,6 hours typical continuous testing.

15.3

Dimension

Unit:mm

Except where noted , tolerance
default as:±3%

(if size<10mm, tolerance:±0.3mm)

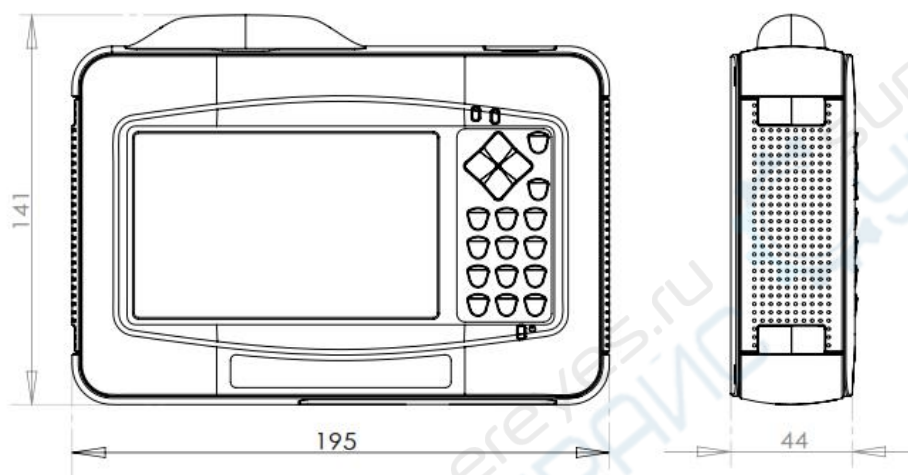

16.0 Warranty

16.1 Terms of Warranty

All Company products are warranted against defective material and workmanship for a period of time from the date of shipment to the original customer. Any product found to be defective within the warranty period would be repaired or replaced by Company free of charge. In no case will Company liabilities exceed the original purchase price of the product.

16.2 Exclusions

The warranty on your equipment shall not apply to defects resulting from the following:

- Unauthorized repair or modification
- Misuse, negligence, or accident

Company reserves the right to make changes to any of its products at any time without having to replace or change previously purchased units.

16.3 Transportation

To return instrument for reasons of yearly calibration or other, please contact us. to obtain additional information and RMA#code(Return Materials Authorization number). And describe briefly reasons for the return of the equipment, to allow us offer you more efficient service.

To return the instrument in the case of repair, calibration or other maintenance, please note the following:

- Pack the instrument with soft cushion like Polyethylene, so as to protect the shell of the instrument.
- Please use the original hard packing box. If use other packing material, please ensure at least 3 cm soft material cover around the instrument.
- Be sure to correctly fill out and return the warranty registration card, which should including following information: company name, postal address, contact, phone number, email address and problem description.
- Seal the packing box with exclusive tape.
- Ship to your representative or the agent of the Company in a reliable way.

16.4 Customer Service and Support

Shanghai Grandway TelecomTech. Co., Ltd.

Address: 6F, Xin'an Building, No.99 Tian Zhou Road,
Caohejing Hi-Tech Park, Shanghai ,200233, China

Tele: +86-21-54451260/61/62

Fax: +86-21-54451266

Email: overseas@grandway.com.cn

Web: www.grandway.com.cn

-----END LINE-----

