

# FeelElec

FY6900 Series Fully Numerical Control  
Dual Channel Function/Arbitrary Waveform Generator

## User's Manual

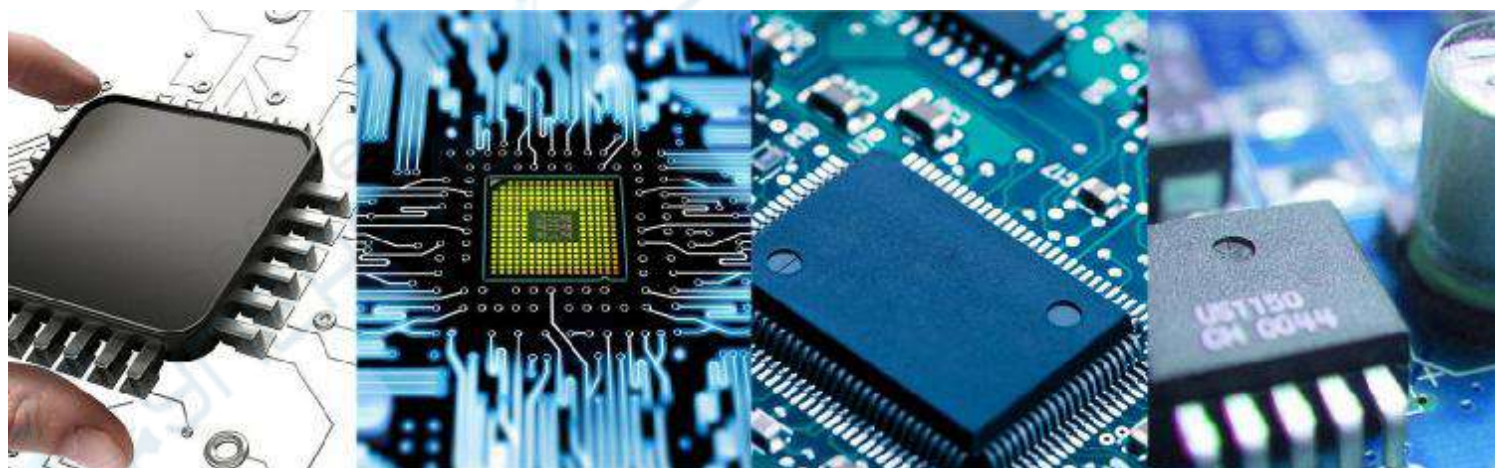

Rev1.0

May, 2019



## Guaranty and Declaration

### Copyright

© 2019 FeelElec Technology Co. Ltd. All Rights Reserved.

### Declaration

- **FeelElec** reserves the right to modify or change parts of or all the specifications and pricing policies at company's sole decision.
- Information in this publication replaces all previously corresponding material.
- **FeelElec** shall not be liable for losses caused by either incidental or consequential in connection with the furnishing, use or performance of this manual as well as any information contained.
- Any part of this document is forbidden to be copied or photocopied or rearranged without prior written approval of **FeelElec**.

### Contact Us

If you have any problem or requirement when using our products or this manual, please contact **FeelElec**.

Tel: 0086 371 68997005 E-mail: [FeelElec@126.com](mailto:FeelElec@126.com)

Website: [www.feelelec.com](http://www.feelelec.com)

## Contents

<b>Guaranty and Declaration</b> .....	1
<b>Product Introduction</b> .....	4
<b>Quick Start</b> .....	7
General Inspection.....	7
Front Panel Overview.....	8
Back Panel Overview.....	11
Power On and Inspection.....	12
User Interface.....	13
Appearance and Dimensions.....	15
<b>Front Panel Operations</b> .....	<b>16</b>
Waveform Output.....	16
Select Output Channel.....	16
Select Waveform.....	17
Set Frequency.....	18
Set Amplitude.....	19
Set Offset.....	20
Set Duty Cycle (Rectangle)&Set pulse wave pulse width (Adj-Pulse).....	21
Set Phase.....	22
Enable Output.....	23
Example: Output Sine Waveform.....	24
Burst.....	26
Modulation Function.....	26
Frequency Meter/Counter.....	28
Enable the Counter.....	28
Set the Counter.....	29
Sweep.....	30
Sweep Object.....	30
Sweep Start Position.....	31
Sweep End Position.....	32
VCO (Voltage Control Output) Sweep.....	33
Sweep Type.....	34
Enable Sweep Function.....	35
System Configuration and Auxiliary Functions.....	36
Save and Load.....	37
Configuration.....	38
Uplink.....	39
Synchronization.....	40
<b>Troubleshooting</b> .....	<b>41</b>
<b>Technical Specification</b> .....	<b>42</b>
<b>Appendix</b> .....	<b>47</b>



## Product Introduction

This manual applies to each model of FY6900series Function/Arbitrary Waveform Signal Generator. The last three characters of the model indicate the up limit output of Sine Wave (MHz). For example, the “**60M**” of the Model Number “**FY6900-60M**” indicates the Sine wave maximum output frequency is up to 60MHz.

FY6900series Dual-channel Function / Arbitrary waveform generator is a set of Function Signal Generator, Arbitrary Waveform Generator, Pulse Generator, Analog / Digital modulator, VCO, Sweep, Counters and Frequency Meter and other functions in a high Performance, cost-effective, multi-function signal generator. Abundant shortcut keys and graphical user interface simplifies every operation. Users do not have to spend a lot of time to learn and familiar with the operation of the instrument, you can be skilled use. For education, research and development, production, testing, maintenance and other industries to provide a new choice.

The instrument adopt the Direct Digital Synthesizer (DDS) technology and provide stable, precise, pure and low distortion signals. Surface mounting technology improves interference immunity and operational life span. Can output up to 97 groups of functions / arbitrary waveform, contains 33 groups of preset waveforms and 64 groups of user-defined waveforms. Preset waveforms: Sine, Square, Rectangle (Duty Cycle adjustable), Pulse (Pulse width and cycle time can be set accurately), Triangle/Ramp, CMOS(0~12V), Four channels TTL, Exponential Rise, Exponential Fall, Noise, ECG, DC etc.

## Main Features:

- u Adopt the Direct Digital Synthesizer (DDS) technology and provide stable, precise, pure and low distortion signals.
- u 2.4 inch TFT Color LCD with 320×240 resolution, displaying parameters and graphics of the two channels at the same time.
- u The instrument uses 14-bit high-speed D/A converter chip (5Vpp output quantization error is less than 1mV), 250MSa/s sample rate, 14bits vertical resolution.
- u Can output up to 97 groups of functions / arbitrary waveform, contains 33 groups of preset waveforms and 64 groups of user-defined waveforms. Preset waveforms: Sine, Square (Duty Cycle adjustable), Pulse (Pulse width and cycle time can be set accurately), Triangle/Ramp, CMOS(0~12V), Four channels TTL, Exponential Rise, Exponential Fall, Noise, ECG, DC etc.
- u Enable to store 64 arbitrary waveform data files, each one of waveform storage depth 8192 points \* 14bits;
- u Various modulation types: AM, FM, PM, ASK, FSK and PSK modulations.
- u Sweep Function: It can sweep 4 properties of signals including frequency, amplitude, offset and duty cycle; It has Linear and Logarithm two sweep types; 0.01S~999.99S sweep time; Up, Down and roundtrip sweep directions.
- u VCO Function (Voltage Control Output): Can be achieved by an external input signal: voltage controlling frequency, voltage controlling amplitude, voltage controlling offset, voltage controlling duty cycle and PWM modulations.
- u Burst Output Function: There has Manual Trigger, internal CH2 Trigger, and External Trigger for your options. It can output 1~1048575 pulse trains.
- u 100M Frequency meter function: It can measure frequency, period, pulse width and duty cycle. Max. frequency workable is 100MHz and Min. frequency workable is 0.01 Hz.
- u Counter Function: It has 2 coupling measure modes including DC coupling and AC coupling. This design can solve inaccuracy problem of AC coupling.
- u Standard dual full functional channels which are equivalent to two independent generators.
- u Channel SYNC Function: Support waveform copy and state copy between channels.
- u Support two or more signal generators connected to achieve multi-channel output, the maximum support 16-channel synchronous output, the phase between each channel can be adjusted.

## FeelElec

---

- u Precisely adjust the phases of the two channels, Precision can be  $0.01^\circ$  .
- u Minimum amplitude resolution can be up to 1 mV. Amplitude range is 0~20Vpp.
- u Duty-cycle of each channel can be adjusted independently 0.01%-99.99%, the adjusting resolution is 0.01%.
- u -12V~+12V DC Offset function. Resolution 0.001V.
- u Save function: It can save 20 sets user-set parameters and can be loaded at any time.
- u Communicating function: All functions can be controlled by PC program and the communication protocol is open for secondary development.
- u Output short-circuit protection: All channels can work more than 60 seconds when the load is short-circuited.
- u Provide powerful waveform editing PC software. Users can download arbitrary waveform to this instrument after edit through PC program which is included in user CD.
- u Adopt ABS plastic shell with table type design. Use 100-240V (AC) wide range voltage power supply.
- u Can choose our FYA2000S series or FPA1000 series power amplifier to output 20W~100W signal in DC-10MHz width without any distortion.



## Quick Start

### General Inspection

Please follow the items below when you receive a new FY6900series Function/Arbitrary Waveform Generator.

#### 1. Inspect the shipping container for damage

Keep the damaged shipping container or cushioning material until the contents of the shipment have been checked for completeness and the instrument has passed both electrical and mechanical tests. The consigner or carrier shall be liable for the damage to instrument resulting from shipment.

#### 2. Inspect the instrument

In case of any damage, or defect, or failure, notify your **FeelElec** sales representative.

#### 3. Check the accessories



Please check the accessories according to the Appendix C ( packing lists). If the accessories are incomplete or damaged, please contact your **FeelElec** sales representative.



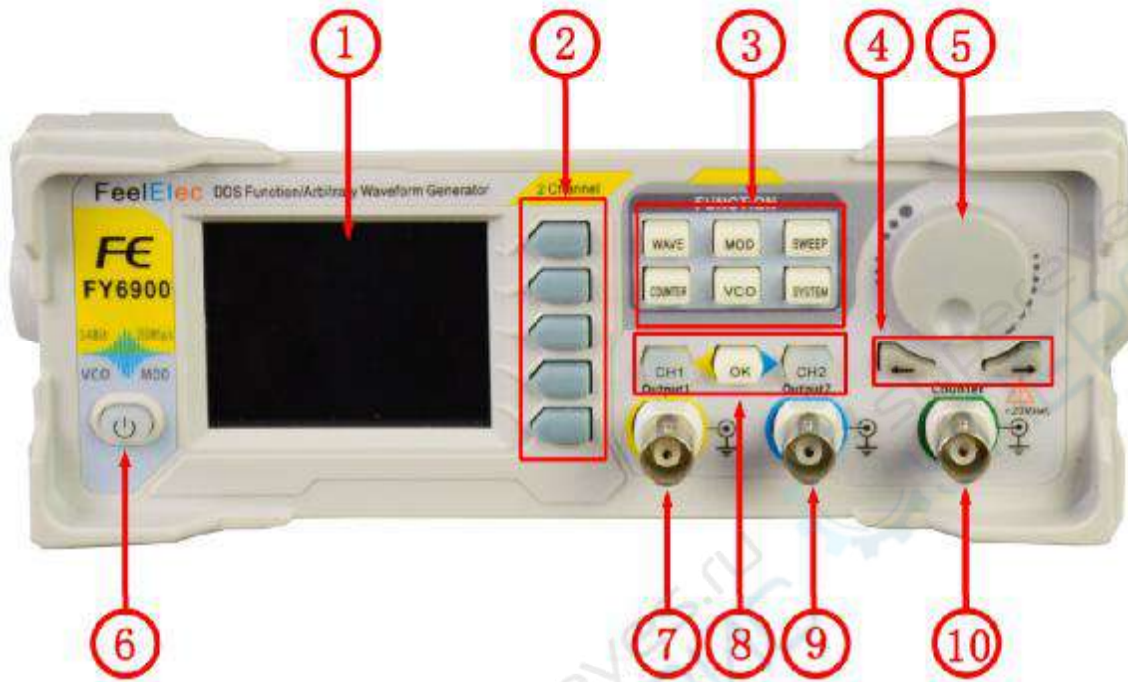

## Front Panel Overview

The front panel is divided into several function areas for easy operation.

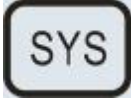

Front Panel

Item	Function	Description
1	LCD	2.4 inch TFT (320×240) color LCD. Operation instruction please check chapter “User Interface” .
2	Manu Buttons	F1~F5 buttons are matched with Manu displayed on the LCD. Press corresponding button to activate submenu represented
3	Function Buttons Area	 — Press this buttons to switch waveforms among Sine, Square,Rectangle, Triangle and so on.
		 — Press this button to switch between frequency meter and counter to measure frequency, period, duty cycle and pulse width of external signal output. — Both DC and AC are workable. — Gate Time can be 1S, 10S or 100S. — Dual channels output and measurement function can work together at same time.
		 — Can sweep Sine, Square, Arbitrary and so on.

		<ul style="list-style-type: none"> <li>— Can sweep frequency, amplitude, offset and phase.</li> <li>— 2 sweep types: Linear, Logarithm.</li> <li>— VCO voltage controls parameters of signal output available (for example: voltage controlled oscillator).</li> </ul>
		 <ul style="list-style-type: none"> <li>— Auxiliary functions and system configuration setting.</li> <li>— Can save 20 sets waveform parameters including frequency, amplitude, offset, phase and so on.</li> <li>— System Language has English and Chinese for user' s option.</li> <li>— Buzzer can be turned on/off in this manu.</li> <li>— Set multimachine uplink.</li> <li>— Switch Master-Slave status</li> <li>— Set default status of dual channels at start-up.</li> </ul>
		 <ul style="list-style-type: none"> <li>— Trigger and modulation function button</li> <li>— Set definite amount of pulse string to output.</li> <li>— Set modulation mode: ASK, FSK, PSK</li> </ul>
		 <ul style="list-style-type: none"> <li>— VCO function can be set</li> <li>— Frequency, Amplitude, Bias and Duty of VCO Voltage Control Signal Generator</li> <li>— Output function of various parameters such as VCO.</li> </ul>
4	Arrows	 Press Arrow buttons to select figure which you want to edit when setting values of each parameter.
5	ADJ Knob	<p>Press the knob as confirmation (OK button).</p> <ul style="list-style-type: none"> <li>— Rotate the ADJ Knob to increase or reduce the current value indicated by the cursor.</li> <li>— Frequency unit can be changed by Press ADJ Knob under Frequency value setting status.</li> <li>— Press ADJ Knob to Start/Stop sweep under Sweep interface.</li> </ul>
6	Power Button	<p>The power indicator keeps illuminating when power on.</p> <p>Press the power button and the indicator change to notifylight status and the signal output terminates.</p>
7	CH1 channel output connector	<p>CH1 connector, output impedance is 50 Ω .</p> <p>When CH1 channel activates (indicator illuminates), CH1 outputs signal with parameters set.</p>
8	Output Channels	 <p>Control CH1 output. Press it to switch to CH1 parameter setting interface.</p> <ul style="list-style-type: none"> <li>— Press it to turn on CH1 output with current configuration. The indicator will illuminate.</li> <li>— Press it again to turn off CH1 output and the indicator will extinguish.</li> </ul>

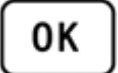
		 <p>Control CH2 output. Press it to switch to CH2 parameter setting interface.</p> <ul style="list-style-type: none"> <li>— Press it to turn on CH2 output with current configuration. The indicator will illuminate.</li> <li>— Press it again to turn off CH2 output and the indicator will extinguish.</li> </ul>
		 <ul style="list-style-type: none"> <li>— Confirm key</li> <li>— When editing the frequency parameters, the unit of frequency can be changed by pressing the knob down.</li> <li>— When scanning the interface, press down the knob to start/stop the scanning state.</li> </ul>
9	CH2 channel output connector	<p>CH2 connector, output impedance is 50 Ω .</p> <p>When CH2 channel activates (indicator illuminates), CH2 outputs signal with parameters set.</p>
10	AC coupling measuring terminal	<p>BNC connector, input impedance 100Ω. For inputting signal of meter or counter.</p>

## Back Panel Overview

The back panel of FY6900 is as picture 1-2 below. 4 BNC terminals on the left are DC coupling measuring terminals Trig/FSK/ASK/PSK IN, external sweep input VCO IN, Synchronization output connector SYNC OUT, and Synchronization input connector SYNC IN. Then follows TTL output terminal, USB terminal, power switch and power input socket.



### 1. BNC connector

Trig/FSK/ASK/PSK IN: DC coupling measuring terminal and ASK/PSK/FSK modulation trigger input terminal.

VCO IN: External signal sweep input terminal can realize voltage controlling frequency, voltage controlling amplitude, voltage controlling offset, voltage controlling duty cycle and so on. Frequency of external signal input should be lower than 500 Hz.

SYNC OUT: Synchronization signal output terminal.

SYNC IN: Synchronization signal input terminal.

### 2. TTL signal output

Frequency of Port A is same with frequency of CH1 output. Frequency of Port B is same with frequency of Port A but with reverse phase ( $180^\circ$ ).

Frequency of Port C is same with frequency of CH2. Frequency of Port D is same with Port C but with reverse phase ( $180^\circ$ ).

### 3. USB Device interface

It's for communication with PC (This is a USB-TTL serial port and driver is needed). Can programming by host computer.

### 4. Power switch and Power input socket(voltage range AC100V-AC240V).



#### Warning

To avoid instrument damage, voltage of signal input from EXT.IN CANNOT exceed  $\pm 20\text{Vac} + \text{dc}$ . Voltage of signal input from Trig/FSK/ASK/PSK IN CANNOT exceed DC5V.



#### Note

To ensure the normal work, please use 100-240V AC power supply.

## Power On and Inspection

### Connect to Power

Please connect the generator to AC power supply using the Power cable supplied in the accessories. The power supply use 100-240V AC power. The power of this instrument is less than 5W.

### Power On

Turn on the power switch after the power cord is connected. The generator will execute self-inspection. The LCD will show welcome interface after the inspection is over. If the generator cannot work normally, please check the Chapter “Troubleshooting” for solution.

### Set the System Language

FY6900series Function/Arbitrary Waveform Generator supports Chinese and English system languages. You can press **SYS**→**CONF** to switch the system language.



## User Interface

The user interface of FY6900 provides four types of display modes: Dual Channels Parameters (default), Single Channel Extension, Auxiliary Functions and System Interface.

### Dual Channels Parameters (default)

The upper half of LCD displays the channel selected currently and the parameters can be set. Press **CH1** or **CH2** to change current channel selected.

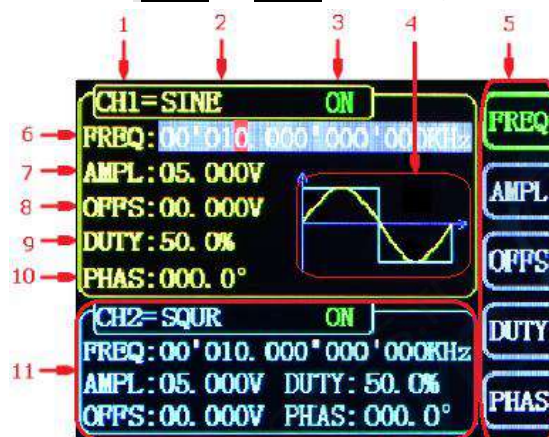

1-4 User Interface (CH1 selected)

Item	Description
1	Current channel selected. Display current channel selected for operation.
2	Current waveform selected. Display the name of current waveform selected. For example, “CH1=Sine” means current waveform selected of CH1 is Sine Wave. It can be changed by press <b>WAVE</b> button. Meanwhile, waveform can be changed quickly by rotating ADJ Knob when waveform switch function is activated.
3	Output status of current channel. Display On/Off status of current channel. It can be switched by Press <b>CH1</b> or <b>CH2</b> .
4	Waveform Display diagram of current waveform (Including Arbitrary) . Yellow indicates CH1 and blue indicates CH2.
5	Manu Bar Display current operable options .

6	Frequency	Display frequency value of current channel. Press <b>FREQ</b> button to highlight it and use ADJ Knob and Arrows to change the value.
7	Amplitude	Display amplitude value of current channel. Press <b>AMPL</b> button to highlight it and use ADJ Knob and Arrows to change the value.
8	Offset	Display DC Offset value of current channel. Press <b>OFFS</b> button to highlight it and use ADJ Knob and Arrows to change the value.
9	Duty Cycle	Display Duty Cycle value of current channel. Press <b>DUTY</b> button to highlight it and use ADJ Knob and Arrows to change the value.
10	Phase	Display Phase value of current channel. Press <b>PHAS</b> to highlight it and use ADJ Knob and Arrows to change the value.
11	Parameters of the channel unselected.	Display parameters of the channel unselected including frequency, amplitude, offset, phase, duty cycle and output status. These Parameters cannot be changed directly in this interface. If you need to change them, Please switch the channel to be selected.

---



## Appearance and Dimensions



## Front Panel Operations

### Waveform Output

FY6900series can output waveforms (Sine, Square, Triangle/Ramp, Pulse and Noise etc.) from one of the channels separately or from the two channels at the same time. At start-up, the dual channels are configured to output a sine waveform with 10kHz frequency and 5Vpp amplitude by default. Two channels use default setting saved at Position 1 when power on. Users can configure the instrument to output various waveforms.

### Select Output Channel

**CH1** and **CH2** buttons are used to change current channel selected. At start-up, CH1 is displayed on the top with yellow color and CH2 is displayed on the bottom with blue color. Press **CH1** or **CH2** to select channel needed. When selecting CH2 as output channel, CH2 parameters displays on the top for configuration.

**KEY POINT:**

CH1 and CH2 can not be selected at the same time. Users can first select CH1 and then select CH2 after configuring the waveform and parameters of CH1. If you need to change the parameters of two channel at same time, please refer to Chapter “**Synchronization**”.

## Select Waveform

FY6900 can output Function/Arbitrary Waveform including:

- I Sine
- I Square
- I Rectangle
- I Triangle/Ramp
- I Rise Sawtooth
- I Fall Sawtooth
- I Lorenz Pulse
- I Multitone
- I Noise
- I Electrocardiogram (ECG)
- I Trapezoidal Pulse
- I Sinc Pulse
- I Narrow Pulse
- I Gauss White Noise
- I Step Triangle
- I Positive Step
- I Inverse Step
- I Positive Exponent
- I Inverse Exponent
- I Positive Falling Exponent
- I Inverse Falling Exponent
- I Positive Logarithm
- I Inverse Logarithm
- I Positive Falling Logarithm
- I Inverse Falling Logarithm
- I Linear FM
- I AM
- I FM
- I Positive Half Wave
- I Negative Half Wave
- I Positive Half Wave
- Rectification
- I Negative Half Wave
- Rectification
- I User-defined waveform

Press **WAVE** to change waveform selected. Or rotate ADJ Knob under waveform switching status to change waveform. The waveform diagram displays on the screen. Pressing the knob can change to arbitrary waveform directly when choosing waveform. At start-up Sine is selected by default. (Users can also configure start-up waveform. Please check Chapter “Save and Load”).

Waveforms		Sine	Square	Rectangle	Triangle	Sawtooth	Arbitrary
Function Name		SINE	SQUR	Rectangle	TRGL	Ramp	Arb
<b>Parameters</b>	Frequency	✓	✓	✓	✓	✓	✓
	Amplitude	✓	✓	✓	✓	✓	✓
	Offset	✓	✓	✓	✓	✓	✓
	Phase	✓	✓	✓	✓	✓	✓
	Duty Cycle			✓			

Note: Arbitrary waveforms can be edited and downloaded from PC software provided by **FeelElec**. The relevant software and driver can be downloaded from our website: [www.feelelec.com](http://www.feelelec.com) .

### Set Frequency

Frequency is one of the most important parameters of waveforms. For different instrument models and waveforms, the setting ranges of frequency are different. For detailed information, please refer to “**Frequency**” in “**Specifications**”. The default frequency is 10kHz.

Press **FREQ** button to highlight value of Frequency. Then use Arrow buttons and ADJ Knob to set the value. Press Arrows button to move the cursor and rotate ADJ Knob to set the value.

Under setting frequency status, press ADJ Knob to change frequency units among MHz, KHz, Hz, mHz,  $\mu$ Hz.

## Set Amplitude

The amplitude setting range is limited by the “Attenuation” and “Frequency” settings. Please refer to “**Output Characteristics**” in “**Specifications**”. The default value is 5Vpp.

Press **AMPL** button to highlight amplitude value. Then use Arrows button and ADJ Knob to set the value. Press Arrows button to move the cursor and rotate ADJ Knob to set the value.

### Key Points:

1. What's the difference of amplitude in Vpp and the corresponding value in Vrms?

Answer:

Vpp is the unit for signal peak-peak value and Vrms is the unit for signal effective value. The default unit is Vpp.

### Note:

For different waveforms, the relation between Vpp and Vrms is different. The relation of the two units is as shown in the figure below (take sine waveform as an example).

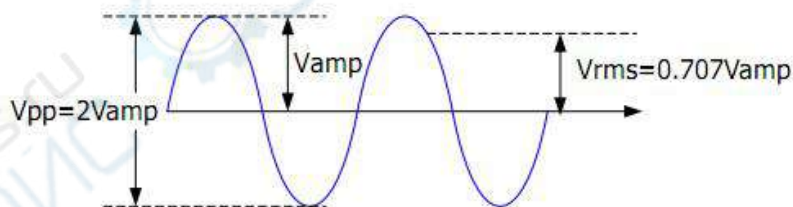

According to the figure above, the conversion relation between Vpp and Vrms fulfills the following equation:

$$V_{pp} = 2\sqrt{2} V_{rms}$$

For example, if the current amplitude is 5Vpp, For sine waveform, the converted value is 1.768Vrms.

### Set Offset

Press **OFFS** button to highlight offset value. Then use Arrows button and ADJ Knob to set the value. Press Arrows button to move the cursor and rotate ADJ Knob to set the value.

The offset accuracy is 1mV. i.e. 0.001V.

When frequency output is lower than 20MHz, the offset can be adjusted during -12V~+12V.

When frequency output is higher than 20MHz, the offset can be adjusted during -2.5V~+2.5V.

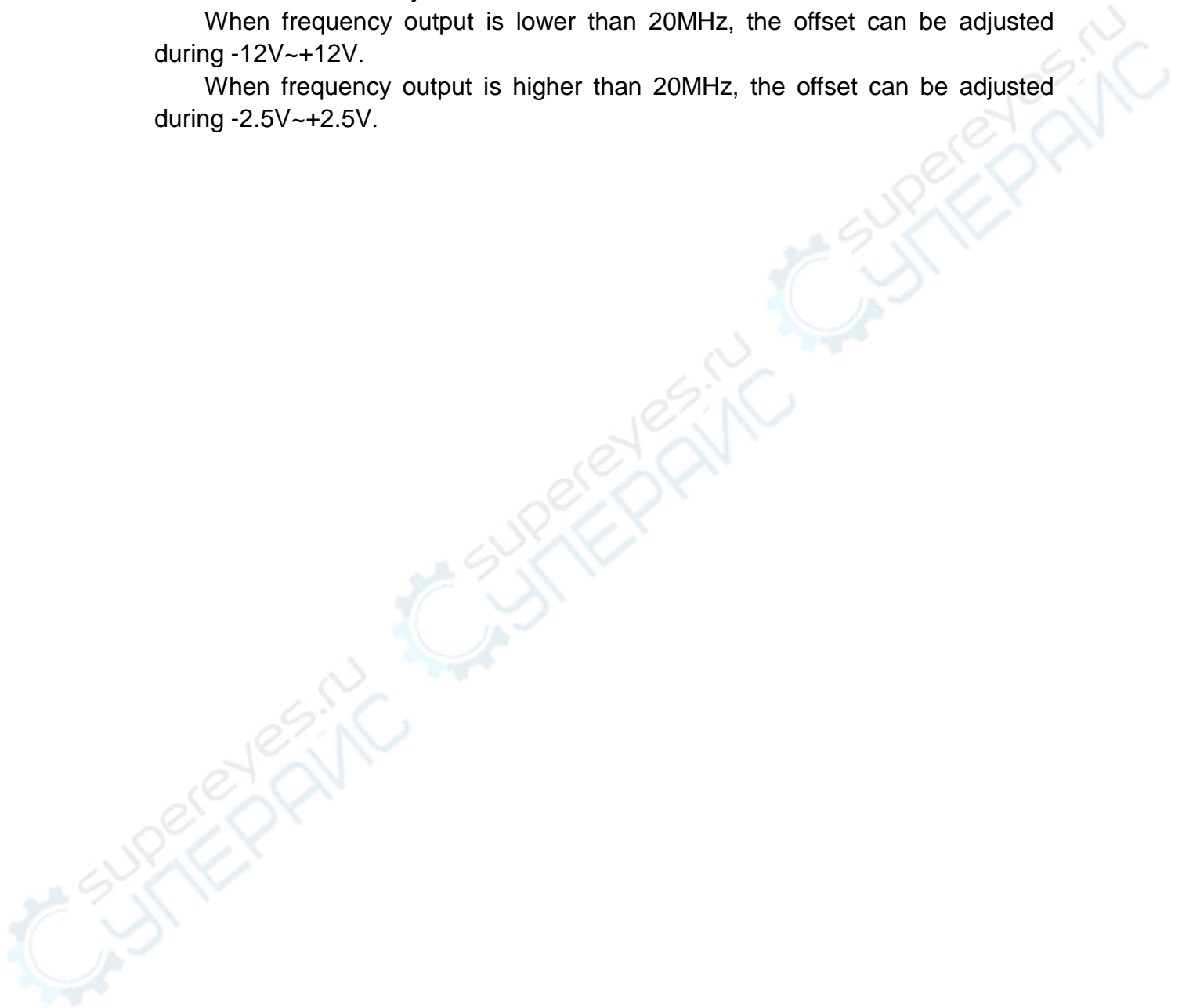

## Set Duty Cycle (Rectangle)

Duty cycle is defined as the percentage that the high level takes up in the whole period (as shown in the figure below). This parameter is only available when Rectangle is selected.

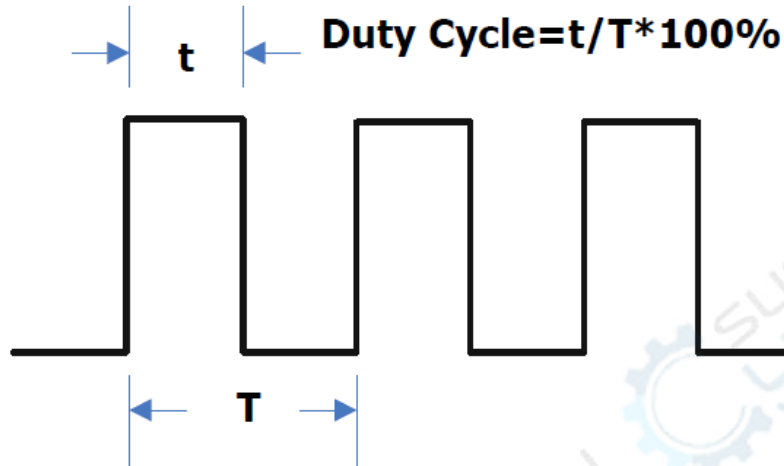

The setting range of duty cycle is limited by the “FREQ” setting. Please refer to “**Waveform Characteristics**” in “**Specifications**”. The default value is 50%.

1. Press **DUTY** button to highlight duty cycle value. Then use Arrows button and ADJ Knob to set the value. Press Arrows button to move the cursor and rotate ADJ Knob to set the value.

- I The setting range of duty cycle is 0.1%-99.9%;
- I Press ADJ Knob under duty cycle setting status will initial the value to 50%.

## Set pulse wave pulse width ( ‘Adj-Pulse’ wave)

Adjustable pulse wave refers to the square wave that can hold the fixed pulse width at any frequency, that is, the pulse width set by the user does not change with the frequency.

Pulse width setting method: in the adjustable pulse wave is selected, press **PULS** button key to adjust the pulse wave pulse width time (Unit ns).The pulse width can be set by the arrow button and the knob. Use the arrow button to move the cursor to select the bit you want to edit, and then turn the knob to modify the value. (Note: Do not set the length of the positive pulse width greater than or equal to the cycle time of the output waveform).

### Set Phase

The setting range of phase is from  $0^{\circ}$  to  $359.9^{\circ}$ . The phase resolution is  $0.1^{\circ}$ . The default phase value is  $0^{\circ}$

The start phase displayed on the screen is the default value or the phase previously set.

Then press **PHAS** button to highlight phase value. Then use Arrows button and ADJ Knob to set the value. Press Arrows button to move the cursor and rotate ADJ Knob to set the value.





## Enable Output

After configuring the parameters of the waveform selected, waveform output could be enabled.

At start-up output of CH1 and CH2 are both turned on as default. At this time indicator lights of dual channels illuminate.

The default status can be modified. Press **【SYS】** button and then press **【MORE】** button to set the output status of dual channels.

For CH1 there are two status:

- 1) Generator is in parameter setting status and current channel selected is CH1, then press **CH1** to switch between output ON/OFF.
- 2) Generator is in other working status or current channel selected is not CH1, then press **CH1** to make CH1 as channel selected and press **CH1** again to switch between output ON/OFF.

For CH2 there are two status:

- 3) Generator is in parameter setting status and current channel selected is CH2, then press **CH2** to switch between output ON/OFF.
- 4) Generator is in other working status or current channel selected is not CH2, then press **CH2** to make CH2 as channel selected and press **CH2** again to switch between output ON/OFF.

### Example: Output Sine Waveform

This section mainly introduces how to output a sine waveform (Frequency: 20kHz, Amplitude:2.5Vpp, DC Offset: 1.6VDC, Start Phase: 90.9°) from the [CH1] channel.

1. Select output channel

Press **CH1** to select CH1. Now all characters and border of the channel is displayed in yellow.

2. Select the Sine

Press **WAVE** button to select Sine. Then the diagram of Sine displays on the screen.

3. Set the frequency

Press **FREQ** button to highlight the frequency value. Press Arrow buttons to move the cursor to the position "2" below. Then rotate the ADJ Knob to get "2".

**FREQ: 00'020.000'000'000kHz**

4. Set the Amplitude

Press **AMPL** to highlight the amplitude value. Press Arrow buttons to move the cursor and rotate the ADJ Knob to get the figures below.

**AMPL: 02.500V**

5. Set Offset

Press **OFFS** to highlight the offset value. Press Arrow buttons to move the cursor and rotate the ADJ Knob to get the figures below.

**OFFS: 01.600V**

6. Set Phase

Press **▼** button to page down and press **PHAS** button to highlight phase value. Then Press Arrow buttons to move the cursor and rotate the ADJ Knob to get the figures below.

**PHAS: 090.9°**

7. Enable the output

Press **CH1** button to turn CH1 output on. The [CH1] connector outputs the configured waveform.

8. Observe the output waveform

Connect the [CH1] connector to the oscilloscope with BNC cable. The waveform is as shown below.

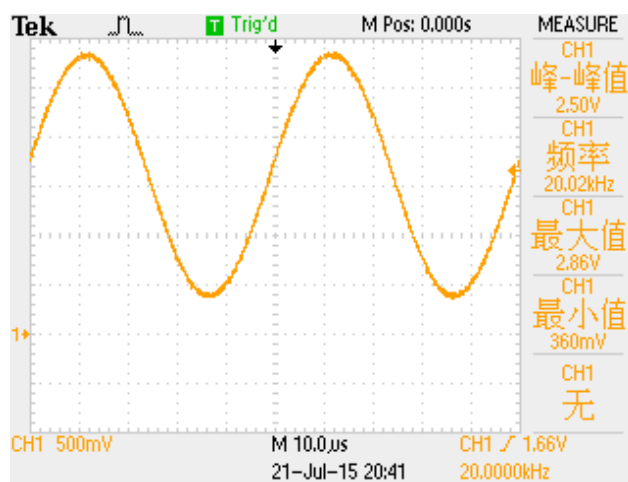

supereyes.ru  
 СУПЕРАЙС

## Burst

FY6900 can output waveform with specified number of cycles (called Burst) from the CH1 channel. FY6900 supports control of burst output by CH2 (internal), manual or external trigger source; The signal generator can generate burst using Sine wave, Square wave, Ramp wave, Pulse, Noise wave or arbitrary waveform (except DC).

### Enable Burst Function

Press the front panel **MOD** button, then press **MODE** button to enter burst function. The instrument supports [CH2], [Ext. AC], [Ext. DC] and [manual] four trigger output modes, which can be selected by the corresponding button. When the burst function is enabled, press the **PARA** button to set the burst output pulse number. Use arrow buttons and ADJ Knob to set the numbers from 1 to 1048575. Then the generator will output burst waveform according to current configuration.

- I CH2 Trigger: CH1 will generate a burst when CH2 generates a pulse.
- I Ext. AC: CH1 will generate a burst when [Input] connector was inputted a pulse.
- I Ext. DC: CH1 will generate a burst when [Trig IN] connector was inputted a pulse.
- I MANU Trigger: User can trigger a burst by pressing ADJ Knob (OK button).



Press the [WAVE] button to change the current burst output signal waveform.  
Press the [FREQ] button to change the current burst output signal frequency.  
Press the [AMPL] button to change the current burst output signal amplitude.

## Modulation Function

Press the **MOD** button to enter the modulation function interface. Press [MODE] soft key, you can choose different modulation types.



Modulation Type	AM, FM, PM, ASK, FSK, PSK
Carrier Waveform	Sine, Square, Triangle, Ramp, Arbitrary waveform (Except DC)
<b>AM</b>	
Source	Internal (CH2) / External (VCO IN Port)
Modulating Waveform	Sine, Square, Triangle, Ramp, Arbitrary waveform
Depth	0% to 120%
Modulating Frequency	Internal : 1μHz~1MHz; External: 1μHz~2KHz;
<b>FM</b>	
Source	Internal (CH2) / External (VCO IN Port)
Modulating Waveform	Sine, Square, Triangle, Ramp, Arbitrary waveform
Modulating Frequency	Internal : 1μHz~1MHz; External: 1μHz~2KHz;
<b>PM</b>	
Source	Internal (CH2) / External (VCO IN Port)
Modulating Waveform	Sine, Square, Triangle, Ramp, Arbitrary waveform
Phase Deviation	0° to 360°
Modulating Frequency	Internal : 1μHz~1MHz; External: 1μHz~2KHz;
<b>ASK</b>	
Source	Internal (CH2), External (ASK IN Port), Manual
Modulating Waveform	Square with 50% duty cycle.
Key Frequency	1μHz~10MHz
<b>FSK</b>	
Source	Internal (CH2), External (FSK IN Port), Manual
Modulating Waveform	Square with 50% duty cycle.
Key Frequency	1μHz~10MHz
<b>PSK</b>	
Source	Internal (CH2), External (PSK IN Port), Manual
Modulating Waveform	Square with 50% duty cycle.
Key Frequency	1μHz~10MHz

## Frequency Meter/Counter

FY6900 provides a counter which can measure various parameters of external input signal such as frequency, period, duty cycle, positive pulse width and negative pulse width. Dual channels output can work together with counter.

### Enable the Counter

Press **MEAS** button of the front panel to enable the counter and measurement Manu. External signal for measurement can be inputted by Input connector(AC coupling) or Trig IN(DC coupling). The result will be displayed on the screen in real time. The lowest frequency workable is 0.01 Hz. (GATE TIME:100S)。

Press **COUN** button to enter external pulse counter function. At this time **COUN** button is turned into **FREQ** button. Repeat pressing this button to switch between **FREQ** and **COUN**.



2-1 Frequency Meter/Counter Interface

When the Frequency Meter/Counter is turned on, press **STOP** button to pause and press **ZERO** button to reset.

#### Key Point:

Amplitude of signal inputted should be bigger than 1.5V. Maximum safe voltage inputted from Input and Trig IN is 5V. The Uplink function need to be turned off when using Counter/Meter.

## Set the Counter

### Gate Time

Press **GATE** button to select gate time. The default is “1S”. It’s better to use “10S” or “100S” as gate time for low frequency signal.

Gate Time	Frequency Resolution
1S	1Hz
10S	0.1Hz
100S	0.01Hz

### Coupling

Set the coupling mode of the input signal to “AC” or “DC” and the default is “AC”.

When the AC coupling mode is selected, signal should be inputted from Input terminal.

When the DC coupling mode is selected, signal should be inputted from Trig IN terminal.

### Sweep

Press **SWEEP** button of front panel to enable sweep function. FY6900 can output sweep from CH1. In sweep mode, the generator outputs signal variably from the start frequency to stop frequency within the specified sweep time. It can generate sweep output for Sine, Square, Triangle/Ramp and arbitrary waveform.



2-2 Sweep setting interface

### Sweep Object

FY6900 can output sweep from CH1. The sweep objects include frequency, amplitude, offset, duty cycle. It can be selected by pressing **OBJE** button.

- I In Frequency Sweep Mode, the generator will output signal variably from start frequency to end frequency within the specified sweep time.
- I In Amplitude Sweep Mode, the generator will output signal variably from start amplitude to end amplitude within the specified sweep time.
- I In Offset Sweep Mode, the generator will output signal variably from start offset to end offset within the specified sweep time.
- I In Duty Cycle Sweep Mode, the generator will output signal variably from start duty cycle to end duty cycle within the specified sweep time.



## Sweep Start Position

When Sweep function is enabled. Sweep start position need to be set according to sweep objects.

- I Frequency Sweep: Press **STAR** button to highlight start frequency parameter. Press the Arrow buttons and rotate the ADJ Knob to set the specified value. For example:

**START: 00'010.000'000'000kHz**

- I Amplitude Sweep: Press **STAR** button to highlight start amplitude parameter. Press the Arrow buttons and rotate the ADJ Knob to set the specified value. For example:

**START: 10.00V**

- I Offset Sweep: Press **STAR** button to highlight start offset parameter. Press the Arrow buttons and rotate the ADJ Knob to set the specified value. For example:

**START: 00.00V**

- I Duty Cycle Sweep: Press **STAR** button to highlight start duty cycle parameter. Press the Arrow buttons and rotate the ADJ Knob to set the specified value. For example:

**START: 50.0%**

## Sweep End Position

When Sweep function is enabled. Sweep end position need to be set according to sweep objects.

- I Frequency Sweep: Press **END** button to highlight end frequency parameter. Press the Arrow buttons and rotate the ADJ Knob to set the specified value. For example:

**END: 00'020.000'000'000kHz**

- I Amplitude Sweep: Press **END** button to highlight end amplitude parameter. Press the Arrow buttons and rotate the ADJ Knob to set the specified value. For example:

**END: 20.00V**

- I Offset Sweep: Press **END** button to highlight end offset parameter. Press the Arrow buttons and rotate the ADJ Knob to set the specified value. For example:

**END: 10.00V**

- I Duty Cycle Sweep: Press **END** button to highlight end duty cycle parameter. Press the Arrow buttons and rotate the ADJ Knob to set the specified value. For example:

**END: 80.0%**

## Sweep Time

When Sweep function is enabled, press **SOUR** button to select it and press it again to change between **TIME** and external sweep (VCO Sweep). Press the Arrow buttons and rotate the ADJ Knob to set the specified value of sweep time. The default is "10S". The work range is 10mS~999.99S. For Example:

**SOUR: TIME 999.99S**

## VCO (Voltage Control Output) Sweep

Function instruction: External voltage can control signal output by External Sweep (VCO) function. It can realize voltage controlling frequency (VCF), voltage controlling amplitude (VCA), voltage controlling offset, voltage controlling duty cycle and so on.

Operation method: Press **[SWEEP]** button to enter sweep function interface. Then press **[F4 SOUR]** button to switch the source to VCO IN. After Sweep Object, Start, End and Sweep Mode being set, connect the external signal from VCO IN terminal on the back panel. Then press the ADJ knob (OK button) to enable VCO sweep function. Press ADJ knob (OK button) again to disable it.

Note: Signal input for External Sweep (VCO) need to be input from VCO IN port of back panel. Its frequency need to be less than 500 Hz and its voltage amplitude need to be among 0~5V.

## Sweep Type

FY6900 provides Linear, Logarithm sweep types. The default is Linear sweep. The sweep type can be switched by pressing “MODE” button.

### Linear Sweep

In linear sweep type, the signal parameter varies linearly. For example, in the frequency sweep the output frequency of the instrument varies linearly in the way of “Changing several Hertz per second”. The variation is controlled by “Start Frequency”, “End Frequency” and “Sweep Time”.

The step value of linear sweep object is computed by the generator, the formula is as follows:

$$\text{Step value} = (\text{End value} - \text{Start value}) / (\text{Sweep time} * 100)$$

### Logarithm Sweep

In linear sweep type, the signal parameter varies logarithmically.

For example, in the frequency sweep the output frequency changes in the way of “octave per second” or “decade per second”. The variation is controlled by “Start Frequency”, “End Frequency” and “Sweep Time”.

When Logarithm Sweep is enabled, users can set the following parameters: Start Frequency ( $F_{start}$ ), Stop Frequency ( $F_{end}$ ) and Sweep Time ( $T_{sweep}$ ).

The function prototype of Logarithm Sweep:

$$F_{current} = P^T$$

$F_{current}$  is the instantaneous frequency of the current output. P and T could be expressed as shown below by the above-mentioned parameters:

$$P = 10^{\lg(F_{stop}/F_{end})/T_{sweep}}$$

$$T = t + \lg(F_{start}) / \lg(P)$$

Wherein,  $t$  is the time from the start of the sweep and its range is from 0 to  $T_{sweep}$ .

## Enable Sweep Function

Press **SWEEP** button of front panel to enable sweep function. Then press ADJ Knob to start sweep process. Press ADJ Knob again to stop sweep.

### Start value and End value

Start value and stop value are the upper and lower limits of sweep for specified parameter. sweep. The generator always sweeps from the start value to the end value and then returns back to the start value and continues indefinitely.

For example, in Frequency Sweep function:

- I Start Frequency < End Frequency: the generator sweeps from low frequency to high frequency.
- I Start Frequency > End Frequency: the generator sweeps from high frequency to low frequency.
- I Start Frequency = Stop Frequency: the generator outputs with a fixed frequency.

When Sweep function is enabled, press **STAR** button to highlight start value. Use arrow buttons and ADJ Knob to set the specified value. Different frequency sweep corresponds to different start frequency and end frequency range.

Sine: 100mHz to 25MHz~60MHZ (Varies according to different model)  
Square: 100mHz to 25MHz  
Ramp: 100mHz to 10MHz  
Arbitrary: 100mHz to 10MHz

The generator will restart sweep (according to the current new configuration) from the specified “start frequency” after start or end frequency is changed.

## System Configuration and Auxiliary Functions

Press **SYS** button of front panel to enter System interface. The interface displays the instrument parameter storage [SAVE] , parameter loading [LOAD] , configuration [CONF] and other functional [MORE] information.

SAVE: To save current parameters of waveform to save positions (20 sets).

LOAD: To load parameters to current working status from save positions.

CONF: To set system language, turn on/off Buzzer and Uplink mode.

MORE: To set default output status of dual channels.

### CH1 BOOT: ON

The default CH1 channel is on to turn on the output state, can press the [ F1 ] button to set the default output status of the CH1 channel.

### CH2 BOOT: ON

The default CH2 channel is on to turn on the output state, can press the [ F2 ] button to set the default output status of the CH2 channel.

## Save and Load

Press **SAVE** button in System interface to save parameters of current waveform to specified position. Press **LOAD** button to load parameters of waveforms previously set to current system status.

Select **S xx** on the right to save current parameters to corresponding position.

Select **L xx** on the right to load parameters from corresponding position to current system status.

- I FY6900 provides 20 positions for saving.
- I The generator will load default parameters from Position 01 automatically after start-up.

## Configuration

Press **SYS** button to enter system interface. Then press **CONF** button to enter system configuration interface. Press corresponding buttons to select system work mode.

- I Press **中文** button to select Chinese as system language.
- I Press **Eng** button to select English as system language.
- I Press **BUZZ** button to turn on/off buzzer. On is the default.
- I Press **M/S** button to set uplink mode: Master/Slave. Master is the default.
- I Press **UPLI** button to turn on/off uplink function. Off is the default.





## Uplink

FY6900 supports multi-machine uplink, which can provide users more channels for output. In uplink network, only one master machine can exist. Others must be set as slave machine. The setting method is as follows:

- I Select on FY6900 as master machine. Press **SYS** -> **CONF** -> **M/S**, to set the UPLINK MODE to be "Master". Press **UPLI**, to set the UPLINK to be "ON".
- I Set all other machines to be slave machines. Press **SYS** -> **CONF** -> **M/S**, to set the UPLINK MODE to be "Slave". Press **UPLI**, to set the UPLINK to be "ON". Repeat this step to set all slave machines.
- I Connect all FY6900 in parallel by SYNC connector.
- I The uplink machines cannot exceed 8 because the driving ability.

When the setting above has been finished, all machines in network will work synchronously according to the start phase of master machine. When outputting signal with same frequency, multi channels output can be executed with phase adjustable.

### Synchronization

Press the [SYNC] button to enter the synchronization function setting interface. Press corresponding buttons on the right to highlight or cancel selecting status.

When the synchronization of corresponding parameters are activated, the corresponding parameters of CH2 will vary according to variation of CH1 automatically. The parameters workable for synchronization include waveform, frequency, amplitude, offset, and duty cycle, which can be set separately.

When **WAVE** is highlighted, the waveform of CH2 will vary according to variation of CH1.

When **FREQ** is highlighted, the frequency of CH2 will vary according to variation of CH1.

When **AMPL** is highlighted, the amplitude of CH2 will vary according to variation of CH1.

When **OFFS** is highlighted, the offset of CH2 will vary according to variation of CH1.

When **DUTY** is highlighted, the duty cycle of CH2 will vary according to variation of CH1.

## Troubleshooting

This chapter lists the commonly encountered failures of FY6900 and their solutions. When you encounter these problems, please solve them following the corresponding steps below. If the problem remains still, please contact **FeelElec** and provide the device information (Press **SYS** to get it).

Failure Phenomena	Solutions
The screen of the generator is still dark (no display) after switch on.	<ol style="list-style-type: none"> <li>1) Check whether the power is correctly connected.</li> <li>2) Check whether the power switch has been pulled in place.</li> <li>3) Restart the instrument after finishing the above inspections.</li> <li>4) If it still does not work correctly, please contact <b>FeelElec</b>.</li> </ol>
CH2 is locked.	<ol style="list-style-type: none"> <li>1) Check that the signal generator is operating in synchronous state. Press the <b>SYNC</b> button to enter the synchronization settings interface to cancel all synchronization parameters.</li> <li>2) If the problem is still, please restart the generator.</li> </ol>
Set correctly, but no waveform output	<ol style="list-style-type: none"> <li>1) Check whether the BNC cable is connected tightly with CH1 or CH2 connector.</li> <li>2) Check whether the BNC cable has internal damage.</li> <li>3) Check whether the BNC cable is connected tightly with the test instrument.</li> <li>4) Check whether the indicators of CH1 or CH2 is turned on. If not press corresponding button to turn it on.</li> <li>5) If the problem is still, please contact <b>FeelElec</b>.</li> </ol>

## Technical Specification

Unless specified, all specifications can be guaranteed if the following two conditions are met.

- I The generator has passed self-inspection.
- I The generator has been working continuously for at least 30 minutes under the specified temperature (18°C~28°C).

All the specifications are guaranteed unless those marked with “typical”

Frequency				
Model	FY6900-20M	FY6900-30M	FY6900-50M	FY6900-60M
Sine	0~20MHz	0~30MHz	0~50MHz	0~60MHz
Square	0~15MHz	0~25MHz	0~25MHz	0~25MHz
Ramp, Triangle	0~10MHz	0~10MHz	0~10MHz	0~10MHz
Pulse	0~10MHz	0~10MHz	0~10MHz	0~10MHz
TTL/CMOS	0~10MHz	0~10MHz	0~10MHz	0~10MHz
Arbitrary Waveform	0~10MHz	0~10MHz	0~10MHz	0~10MHz
Minimum pulse width	20ns(All models of pulse wave minimum width can reach 20ns)			
Min. Resolution on all frequency range	1μHz (Min. resolution can reach 1μHz on all frequency range to ensure adjusting accuracy under high frequency. For example, it can output 10.000000000001MHz signal).			
Accuracy	±20ppm			
Stability	±1ppm/ 3hours			
Waveform Characteristics				
Waveforms	Sine, Square, Rectangle (Duty Cycle adjustable), Pulse (Pulse width and cycle time can be set accurately), Triangle/Ramp, Sawtooth Wave, CMOS, Four channels TTL, DC, Half wave, Full wave, Positive Step, Inverse Step, Positive Exponent, Inverse Exponent, Lorenz Pulse, Multitone, Noise, ECG, Trapezoidal Pulse, Sinc Pulse, Narrow Pulse, Gauss White Noise, AM, FM, and other 64 sets customer-defined waveform.			
Non-Volatile Storage	Can store 64 user-defined arbitrary waveforms, (8K 14bits) * 64			
Waveform Length	8192 points * 14bits			
Sampling Rate	250MSa/s			
Vertical Resolution	14 bits			
Sine	Harmonic Suppression	≥50dBc(<1MHz); ≥45dBc(1MHz~20MHz);		
	Total Harmonic Distortion	<0.5% (20Hz~20kHz,0dBm)		

Rectangle	Rise/Fall Time	≤7ns (VPP<5V)
	Overshoot	≤5%
	Duty Cycle	0.01%~99.99% (Resolution 0.01%)
Sawtooth wave	Linearity	>99% (0.01Hz~10kHz)

### Output characteristics

Amplitude (VPP)	Frequency≤5MHz: 1mVpp~24Vpp; 5MHz<Frequency≤10MHz: 1mVpp~20Vpp; 10MHz<Frequency≤20MHz: 1mVpp~10Vpp; Frequency>20MHz: 1mVpp~5Vpp;
Resolution	1mV
Amplitude Stability	±0.5%/ 5 Hours
Amplitude flatness	±2.5%(<10MHz);±5%(>10MHz);

### Waveform Output

Impedance	50Ω±10% (Typical)
Protection	All channels can work more than 60 seconds when the load is short-circuited.

### DC Offset

Offset Range	Frequency≤20MHz: ±12V; Frequency>20MHz: ±2.5V;
Offset Resolution	1mV

### Phase Feature

Phase range	0~359.99°
Phase resolution	0.01°

### TTL Output

TTL Level Amplitude	>3Vpp
Fan-out	>8 TTL LOAD
Rise/Fall Time	≤10ns

### CMOS Output

Low Electric Level	<0.3V
High Electric Level	1V~12V
Rise/Fall Time	≤18ns

### External Measurement

Function	Frequency, Period, Positive/Negative Pulse Width, Duty Cycle	
Input Voltage Range	1Vpp~20Vpp	
Frequency Meter	Resolution	0.01Hz (Gate Time = 100S)
	Range	0.01Hz~100MHz

	Sensitivity	Gate Time 3 grades (1S, 10S, 100S) adjustable	
Counter	Range	0-4294967295	
	Coupling	DC, AC	
	Working Mode	Manual	
Period	Measurement Range	5ns ~ 20s	DC coupling measurement
Pulse Width	Measurement Range	0ns ~ 20s	
	Resolution	5ns	
Duty Cycle	Range (Display)	0% ~ 100%	

## Sweep

Carrier Waveform	Sine, Square, Ramp, Arbitrary (except DC)		
Sweep Type	Linear or Logarithm		
Sweep Direction	Up, Down and roundtrip sweep directions;		
Sweep Objects	Frequency, Amplitude, Offset, Duty Cycle		
Sweep Time	0.01S~999.99S/Step		
Setting range	Starting position and Finishing position can be set arbitrarily.		
Sweep Range	Decided by Parameters setting.		

## VCO (Voltage Control Output)

Modulation signal range to input	0~5V		
VCO signal frequency range	0-2000Hz		
VCO control object	voltage controlling frequency (VCF), voltage controlling amplitude (VCA), voltage controlling offset, voltage controlling duty cycle.		
VCO special function	Can Amplitude Modulate (AM) or Frequency Modulate (FM) by external analog signal.		

## Modulation

Modulation Type	AM, FM, PM, ASK, FSK, PSK		
Carrier Waveform	Sine, Square, Triangle, Ramp, Arbitrary waveform (Except DC)		

### AM

Source	Internal (CH2) / External (VCO IN Port)		
Modulating Waveform	Sine, Square, Triangle, Ramp, Arbitrary waveform		
Depth	0% to 120%		
Modulating Frequency	Internal : 1μHz~1MHz; External: 1μHz~2KHz;		

### FM

Source	Internal (CH2) / External (VCO IN Port)		
Modulating Waveform	Sine, Square, Triangle, Ramp, Arbitrary waveform		
Modulating Frequency	Internal : 1μHz~1MHz; External: 1μHz~2KHz;		

### PM

Source	Internal (CH2) / External (VCO IN Port)
Modulating Waveform	Sine, Square, Triangle, Ramp, Arbitrary waveform
Phase Deviation	0° to 360°
Modulating Frequency	Internal : 1μHz~1MHz; External: 1μHz~2KHz;

**ASK**

Source	Internal (CH2), External (ASK IN Port), Manual
Modulating Waveform	Square with 50% duty cycle.
Key Frequency	1μHz~10MHz

**FSK**

Source	Internal (CH2), External (FSK IN Port), Manual
Modulating Waveform	Square with 50% duty cycle.
Key Frequency	1μHz~10MHz

**PSK**

Source	Internal (CH2), External (PSK IN Port), Manual
Modulating Waveform	Square with 50% duty cycle.
Key Frequency	1μHz~10MHz

**Burst Function**

Carrier Waveform	Sine, Square, Ramp, Arbitrary (except DC)
Burst Count	1~1048575
Trigger Source	Manual, Internal, External (AC/DC)

**General Specifications**

Display	Type	2.4 inch, TFT Color Display.
Save & Load	Amount	20
	Position	01 to 20 (01 for start default value)
Interface	Type	USB to Serial interface
	Protocol	Command line mode, providing communication protocols.
	Communicating Speed	9600bps (Industrial standard)
Power	Voltage Range	AC100V~240V
Technic	SMD, LSI, Reliable and durable	
Buzzer	Can be turned on/off by setting.	
Operation	Buttons and knob continuously.	
Environment	Temp.: 0~40°C, Humidity: < 80%	
Size	200mm * 190mm * 90mm (L * W * H)	
Weight	850g	
Package Size	25cm * 21cm * 10cm (L * W * H)	
Package Weight	0.98kg(Main engine, accessories and packing materials)	





## Appendix

### Appendix A: Safety Notes

1. Before using this instrument, please check if the power supply is normal, to ensure the normal use and personal safety.
2. This instrument must be used in the technical index range.
3. Please do not change the instrument circuit arbitrarily, so as to avoid damaging equipment or endangering the safety.

### Appendix B: Warning and personal injury

Do not apply the product in the safety protection device or emergency stop device, or any other applications that the product failure could result in personal injury, unless there is special purpose or use authorization. Before the installation and use, each parameter of the technical indexes in this manual should be referred to. If this suggestion is not obeyed, death or serious personal injury could be caused. In this condition the company will not be responsible for any compensation of personal injury or death, and all the company managers and employees and auxiliary agents, distributors, other personnel concerned will be released from any claim (including all the costs, expenses, attorney fees etc.) that may result in.

### Appendix C: Accessories and Options

	Description	Quantity
<b>Model</b>	FY6900 Series DDS Signal Generator	1
<b>Standard Accessories</b>	Power Cable	1
	USB Data Cable	1
	BNC-Clip Cable	2
	BNC-BNC Cable	1
	Warranty Card	1
<b>Options</b>	<a href="#">FYA2000 Series Amplifier</a>	
	<a href="#">FPA1000 Series Amplifier</a>	

**Note:** Options can be ordered from local **FeelElec** distributors.

### Appendix D: Warranty

**FeelElec** warrants that its products mainframe and accessories will be free from defects in materials and workmanship within the warranty period. If a product is proven to be defective within the respective period, **FeelElec** guarantees the free replacement or repair of products which are approved defective. This product enjoy 1 year warranty since its delivery. Damages caused by misuse, vandalism, improper maintenance or force majeure are not covered by the warranty. Any disassembly or amendment without permission will be deemed giving up warranty rights consciously.