

Digital Earth Resistance Tester 4300

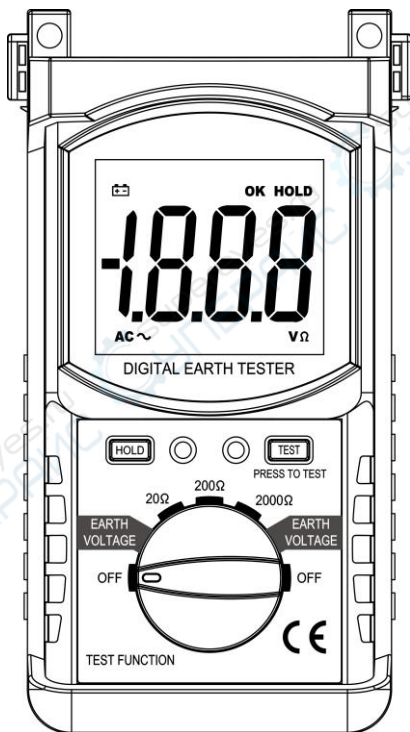

Table of contents

1.General Introduction.....	1
2.Safety Rules.....	1/2
3.Performance Features.....	2
4.Technical Indicators.....	2/3
5.Operation Diagram.....	3/4
6.Operation Instruction.....	4/7
7.Battery replacement.....	8
8.Maintenance.....	8
9.Accessories.....	8

1. General Introduction

This Digital Earth Resistance Tester is a new generation tester for electrician practice which is developed by our company in recent years. The circuit, structure and technique of traditional earth resistance tester have been improved and the new design is both fine-looking and practical. This one has more complete functions, higher accuracy, more convenient and reliable for operation and more suitable for outdoor use with dust and wet proof structure. It can test earth resistance of various earth systems including power systems, electric equipment, lightning conductors as well as resistance value of low resistance conductor and AC voltage test.

2. Safety Rules

- (1) Please read this manual carefully before use.
- (2) It should not be used before placing the back cover back to avoid risk of electric shock.
- (3) Please do not touch lead terminal and circuit under test to avoid electric shock.
- (4) Please make sure the range select switch setting within the proper range before test.
- (5) Make sure the couple plug of lead inserted in the terminal tightly.
- (6) When the tester is wet, do not use it or replace battery.
- (7) Please do not turn the switch during test.
- (8) Please do not test in flammable places since sparkles may cause explosion.
- (9) Please stop use when metal is exposed due to breakage of casing or testing wire. Make sure the isolation skin of testing wire is intact before use.
- (10) Please make sure the testing wire has been removed from testing terminal and the range select switch is on off position before replacing battery
- (11) Please make sure the range select switch is on off position after use.

- (12) Be extremely careful not to get electric shock as a maximum voltage of 50V is present between terminals (E-C and E-P) during measurement.
- (13) Do not apply voltage greater than 200V between terminals E-P.
- (14) Do not use this instrument to check an earth of a commercial power supply or for voltage measurement when making simplified measurement using an earth of a commercial power supply.
- (15) "1" shows overrange. Select the higher range and re-test.
- (16) Replace battery when "BAT" shown on tester or the battery indicator light is off to ensure testing accuracy. Please remove the battery if not use it for long time.

3. Performance Features

- (1) Measuring range of earth resistance: 0-2000 Ω .
- (2) Measuring range of earth voltage: 0-200V.
- (3) 3 1/2 digit LCD display for more direct and convenient reading.
- (4) Size of LCD: 68×55mm (Height of character is 35mm).
- (5) Response time: Measure earth resistance, about 5 seconds. Measure earth voltage, about 2 seconds.
- (6) Withstand voltage: AC 1500V, 1 minute between circuit and outer casing.
- (7) Overload protection : On earth voltage, can withstand 300V AC (1 minute). On earth resistance, can withstand 200V AC (10 seconds).
- (8) Power supply: 1.5V × 6 R6P AA SUM-3 batteries.
- (9) Dimensions: 218×122×75mm.
- (10) Weight: about 900g (contain battery).
- (11) Working environment:

Working temperature: 0°C ~ 40°C, relative humidity < 80%

Storage temperature: -10°C ~ 50°C, relative humidity < 85%

Ensure accurate temperature: 23°C ± 5°C relative, humidity < 75%

4. Technical Indicators

Earth resistance

Range	accuracy	resolution
20 Ω	$\pm(2\% \text{ rdg} + 0.1\Omega)$	0.01 Ω
200 Ω	$\pm(2\% \text{ rdg} + 3\text{dgt})$	0.1 Ω
2000 Ω		1 Ω

Earth voltage

Range	accuracy	resolution
200V	$\pm(1.0\% \text{ rdg} + 4\text{dgt})$	0.1V

5. Operation Diagram

- ① “C(H)” port (current pole)
- ② “E” port (earth electrode)
- ③ “P(S)” port (electric potential pole)
- ④ LCD display
- ⑤ Earth resistance test indicator light
- ⑥ **TEST** key: Earth resistance testing button
- ⑦ **CDS** sensor: The CDS sensor can reaction to the ambient brightness range, then automatically control the LCD backlight to lighten or go out.
- ⑧ **HOLD** key: Press the “**HOLD**” key to lock display value, and the “**HOLD**” sign will appear on the display, press it again to exit.
- ⑨ Function switch

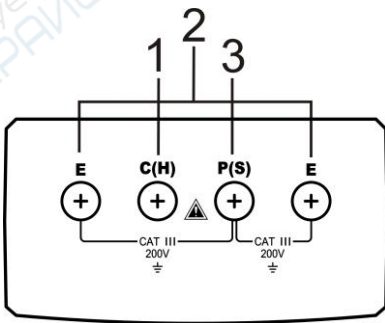

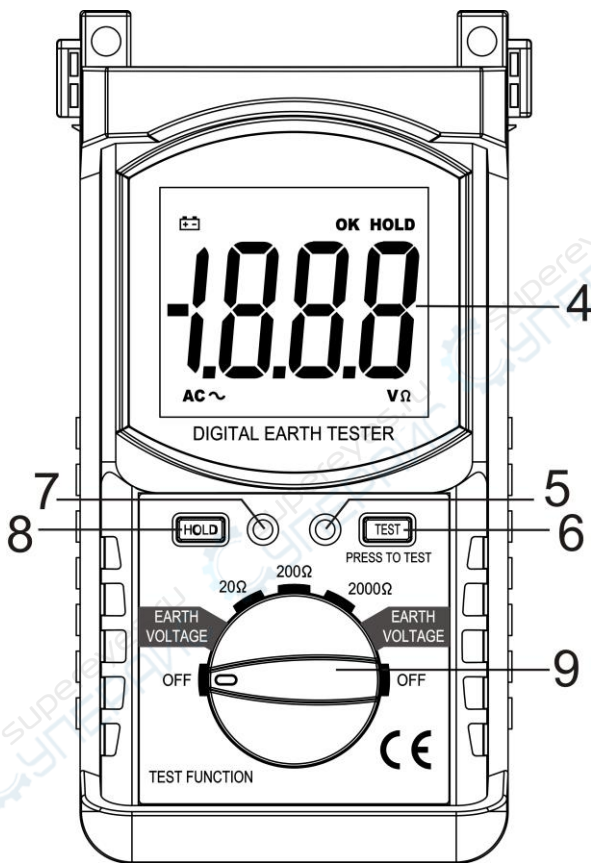

6. Operation Instruction

(1) Battery Voltage Check

If a battery symbol “” shows, do not proceed with testing.

Risk: ⚠ maximum 50V voltage may be generated between E-C or E-P terminals when testing earth resistance!

Please do not touch testing lead to avoid electric shock.

Please make sure testing wire plug insert in testing terminal thoroughly before testing since loose connection may cause error in testing result.

(2) Test Leads Connection (Precise measurement)

Stick the attached auxiliary earth spikes in line and connect the test leads as shown below.

Punch assistant earth bar P(S) and C(H) in earth 5 to 10 meters distant from tested earth substance, Connect green wire to terminal E, yellow wire to terminal P(S) and red wire to terminal C(H).

Note: Please place assistant earth bar in land with high water content. You need add water in dry land, sand land or land containing crushed stones to maintain humidity of inserting position of earth bar.

Lie earth bar flat and add water when meeting cement ground and cover wet towel, etc on earth bar before testing.

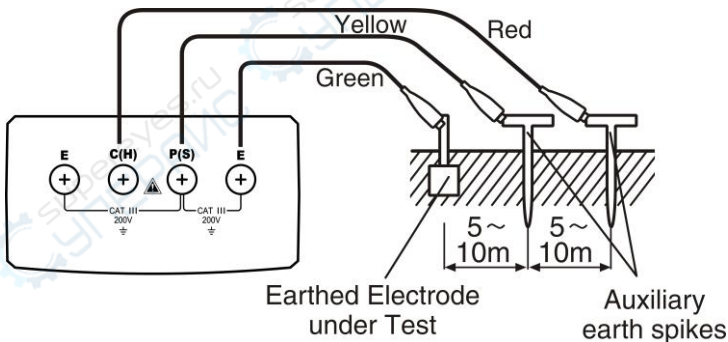

E: Connects earth electrode port

P(S): Connects electric potential pole port

C(H): Connects current pole port

(3) Earth Voltage Measurement

Set the range switch to **EARTH VOLTAGE** position and make sure that the indicated value is 10V or less.

If the earth voltage is higher, it may result in excessive errors in earth resistance measurement.

At this point, one can break the power supply of tested earth electrode equipment to lower earth voltage and then measure the value.

(4) Checking of Auxiliary Earth Spikes Connection

(Check Function of Auxiliary Earth Resistance)

Set the range switch to $2000\ \Omega$ position and press the “**TEST**” button. If the auxiliary earth resistance is too high, the “. . .” blinks.

Reduce the resistance by rechecking the connection, changing the site to stick earth spikes, or pouring water over the spikes.

(5) Measurement (Precise Measurement)

Set the range switch to the desired position, press the “**TEST**” button.

First please press “**TEST**” beginning from $2000\ \Omega$. If the show value is too small, switch to $200\ \Omega$ or $20\ \Omega$ and the show value here is namely the tested earth resistance value.

Note: Make sure connecting wires separated during wire connecting since testing when testing leads wind about with each other may encounter mutual inductance to affect reading. The assistant earth resistance value may be too big and error may occur be too big and error may occur to show value. Make sure assistant earth bar P(S) and C(H) into wet land and complete contact of connecting parts.

(6) Measurement (Simplified measurement)

When auxiliary earth spikes can not be stuck, an approximate earth resistance can be obtained by two-wire system designed to make measurement using an existing earth electrode.

Make sure to use the specified simplified measurement probe.

① Connecting testing wires.

Please connect simple testing wires according as shown below.

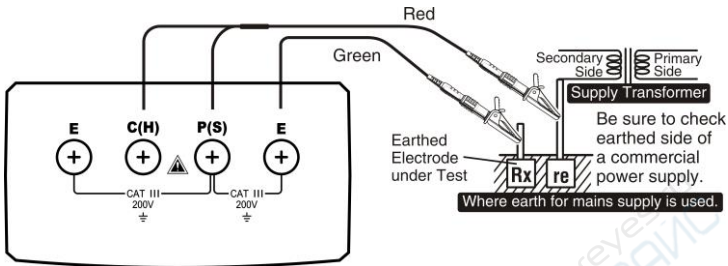

Risk: Be careful of electric shock when using commercial electric system earth method for test.

Please do not use this tester to measure supply voltage.

② Earth voltage measurement

Set the range switch to **EARTH VOLTAGE** position and make sure that the indicated value is 10V or less.

If the earth voltage is higher, it may result in excessive errors in earth resistance measurement.

At this point, one can break the power supply of tested earth electrode equipment to lower earth voltage and then measure the value.

③ Measuring earth resistance

Set the range switch to the desired position and press the “**TEST**” button. First please press “**TEST**” beginning from 2000 Ω. If the show value is too small, switch to 200Ω or 20Ω and the show value here is namely the tested earth resistance value.

Note: When measuring current is about 2mA, even the residual current circuit breaker can not take effect.

Calculate the real earth resistance value R_x by equation below:

$$R_x = R_e - r_e$$

R_x : True Earth resistance

R_e : Indicated Value

r_e : Earth Resistance of earth Electrode

7. Battery replacement

- (1) When the battery voltage drop below proper operation range, the “” symbol will appear on the LCD display and the battery need to be changed.
- (2) Before changing the battery, set the range switch to “OFF” position.
- (3) Open the cover of the battery cabinet by a screwdriver.
- (4) Replace the old battery with the same type battery.
- (5) Close the battery cabinet cover and fasten the screw.

Caution: Dispose the used batteries according to the rules, which are defined by each community.

8. Maintenance

This is a precise instrument and needs careful maintenance.

- (1) Don't open the back lid at will. Don't use it if the back lid is not fixed.
- (2) Put it in a place dry and airy if the meter will be left unused for a long time.
- (3) Don't change the inner circuit at will or the meter may be out of use. If there is any problem, contact with us please.

9. Accessories

- (1) Assistant earth bar: 2 bars
- (2) Testing wire: 1 set
(including red testing wire 15 meters each, yellow testing wire 10 meters each and green testing wire 5 meters each)
- (3) Simple testing wire: 1 set
(including red testing wire 1.6 meters each and green testing wire 1.6 meters each)
- (4) 1.5V (R6P AA) battery: 6 pieces
- (5) User's manual: 1 piece



1141 Budapest, Fogarasi út 77. 1095 Budapest, Mester utca 34.
Tel.: *220-7940, 220-7814, 220-7959, Tel.: *218-5542, 215-9771, 215-7550,
220-8881, 364-3428 Fax: 220-7940 216-7017, 216-7018 Fax: 218-5542
Mobil: 30 531-5454, 30 939-9989 Mobil: 30 940-1970, 20 949-2688

E-mail: delton@delton.hu Web: www.delton.hu

www.holdpeak.hu