



MCR-9000 Series

Precision Impedance Analyzer

User Manual



Version	1.321
Firmware Ver	19.1101
Date	2020/5/29

Copyright and Trademark

Do not attempt to reproduce any part of this publication or transmit it by any form or method, whether through electronic, mechanical, copying, recording or other means, without the prior written permission of MATRIX Co., Ltd. We shall neither be subjected to any responsibilities or obligations for the information contained in this Manual nor do bear damage responsibility resulting from the use of the information contained herein.

All brands and trademark are the properties of MATRIX Co., Ltd.

MATRIX Co., Ltd. and its affiliates shall not be liable for the damage, losses or costs incurred due to the accidental use, misuse or abuse by the product buyer or the third party; or the unauthorized modification, repairs or change of the product; or the failure in following the operation and maintenance instructions established by MATRIX.

The content and the product specifications shall be subject to change without further notice.

2020 @ MATRIX Corporation. All rights reserved.

INDEX

1. Safety Specification.....	2
2. Preface.....	4
2.1 Introduction.....	4
2.2 Key Feature.....	4
2.3 Specification.....	5
3. Description of Installation.....	7
3.1 Package & Equipment.....	7
3.2 Description of function keys on front panel.....	8
3.3 Description of function keys on back panel.....	9
3.4 Hardware Installation.....	10
3.4.1 GPIB Connecting.....	10
3.4.2 RS232 Connecting.....	11
3.4.3 Handler Interface.....	12
3.4.4 Fixture Connecting.....	14
3.4.5 LAN Port.....	15
3.4.6 Power Cord Connecting.....	16
4. Basic Measuring.....	17
4.1 Meter Mode.....	17
4.2 FREQ(Frequency).....	17
4.3 LEVEL.....	17
4.4 RANGE AC.....	17
4.5 SPEED.....	17
4.6 BIAS.....	18
4.7 RANGE DC.....	18
4.8 TRIG.....	18
4.9 COMP.....	18
4.10 Parameters.....	19
4.11 MEASURER MODE SETUP.....	20
4.11.1 TRIGGER DELAY.....	20
4.11.2 AC/DC DELAY.....	20
4.11.3 AVERAGE.....	20
4.11.4 DISPLAY Vm/Im.....	20
4.11.5 BEEP WHEN.....	21
4.11.6 STATISTICS.....	21
4.11.7 FONT SIZE.....	21

4.12	TRIGGER MODE	22
4.13	LEVEL/RO/ALC	22
4.13.1	RO (Output Impedance)	22
4.13.2	ALC (Auto Level Control)	23
4.14	SET ϵ_r	24
4.15	Dielectric Coefficient Measurement Method	24
4.16	SET μ_r	25
4.17	Magnetic Permeability Coefficient Measurement Method	25
4.18	COMP (Comparison)	26
4.18.1	COMPARATOR SETUP	26
4.18.2	COMP (Comparator) MODE & DISP (Display) Mode	27
4.18.3	UPPER	28
4.18.4	LOWER	28
4.19	BIN SETUP	28
4.19.1	PARAMETER and BIN NUMBER	28
4.19.2	BIN METHOD	29
4.20	FILE	31
4.20.1	RECAL	31
4.20.2	NEW	31
4.20.3	SAVE AS	31
4.20.4	DELETE	31
4.20.5	USB FILE	32
4.20.6	COPY>USB	32
5.	LIST TEST	33
5.1	LIST SET	33
5.2	LIST MODE SETUP	34
5.2.1	TRIGGER MODE	34
5.2.2	TRIGGER DELAY	34
5.2.3	Automatic trigger determination point mode	34
5.2.4	OUTPUT IMPEDANCE	35
5.2.5	ALC	35
5.2.6	BEEP WHEN	35
5.2.7	RANGE HOLD	35
5.2.8	FAIL RESET	35
5.2.9	STATISTICS	36
5.2.10	TERMINATED AT NG STEP	36

5.2.11	PRESET	36
5.3	CORR.(LIST CORRECTION)	36
6.	SWEEP	37
6.1	SWEEP MODE SETUP	37
6.1.1	SWEEP DELAY	38
6.1.2	OUTPUT IMPEDANCE	38
6.1.3	KEEP PREVIOUS TRACE	39
6.1.4	TRACE A/B COLOR	39
6.1.5	PRESET	39
6.1.6	CURSOR	40
6.1.7	AUTO FIT	40
6.1.8	TYPE	40
6.1.9	X-AXIS	41
6.1.10	START/STOP	41
6.1.11	LEVEL	41
6.1.12	TRIG	41
6.1.13	SPEED	42
6.1.14	FUNC	42
6.1.15	TRACE A/B PARA	42
6.1.16	TRACE A/B Y-AXIS	43
6.1.17	TRACE A/B REF	43
6.1.18	TRACE A/B POS	43
6.1.19	TRACE A/B DIV/DECADE	44
6.2	Equivalent Circuit Analysis (option)	45
7.	CORRECTION	47
7.1	Open Circuit Correction	48
7.2	Short Circuit Correction	49
7.3	HF LOAD	50
7.4	SPOT LOAD	50
7.5	CABLE LENGTH	50
7.6	FIXTURE COMPENSATION	51
7.7	Spot. No.	51
7.8	FREQUENNCY	51
7.9	LOAD FUNCTION	52
7.10	Reference	52
7.11	Load	52

8. SYSTEM CNOFIG	53
8.1 LANGUAGE	53
8.2 GPIB ADDRESS	53
8.3 RS232 BAUD RATE	53
8.4 RS232 EOI	53
8.5 LAN PORT	53
8.6 HANDLERINTERFACE	54
8.7 KEY BEEP	54
Appendix	55
 Z Accuracy Chart	55
Measurement accuracy	56
Concept of Command	58
Subsystem Command Tree	58
Data Format	59
Common Commands	60
MEASure Subsystem	64
LIST Subsystem	73
SWEep Subsystem	80
Read the measured value	88
Measurement Basics	89
Resistance (R) and Conductance (G)	90
◆ Capacitance (C)	91
Inductance (L)	92
◆ Reactance (X) and Susceptance (B)	93
◆ Impedance (Z) and Admittance (Y)	94
◆ Quality factor (Q) and Dissipation factor (D)	95
◆ Phase angle (θ)	96
Overall Impedance Measurement Theory	97
Characteristics Example	100
High and low impedance criteria	101

1. Safety Specification

This instrument is designed according to EN61010-1 Specification. The main purpose of this Specification is to ensure that the instrument will be used in the laboratory or the factory safely; it is not suitable for outdoor applications, especially the moistened or dusty locations. Abnormal use of this instrument may cause the electrocution hazard. Before using this instrument, please read the descriptions of this Specification carefully to avoid causing accident due to incorrect or unintended use.

1.1 Safety marks (the following safety marks may appear in this Manual)



Caution :

Please read the content of this Manual carefully.



High-voltage hazard symbol:

The output terminal may release lethal voltage. Please read the safety instructions described in this chapter.



Grounding:

Before working with this tester, be sure to connect this terminal with the ground to prevent from touching the housing as to cause electrocution accident due to current leakage.



Warning sign :

If the product is improperly used, it may cause adverse result to the instrument or the Test Piece. If the product is improperly used, it may cause injury or even death.

1.2 Electrocution

To prevent electrocution accident from occurring, it is suggested that the operator wear insulating rubber globes before working with the machine and then start the test-related activities.

1.3 Grounding

The back panel of the instrument is fitted with a safe ground terminal. Be sure to connect this ground terminal to the ground to prevent the operator from touching the housing as to cause the electrocution.

1.4 Power Source

The scope of power used by this instrument is 88~264Vac. To insert the power source, please check if the power to be connected is identical with the power-shifting sign indicated on the back panel. When changing the fuse, it is required to use specific type of fuse designed in same ampere to prevent the electrical wire from burning. Before making any replacement, please remove the plug to prevent danger.

1.5 Warm-up

The instrument will operate normally upon starting the power. To achieve the specified accuracy, it is suggested warming up the instrument for over 30 minutes

1.6 External control unit

This unit is able to execute the external control. For this purpose, please ensure that the operator is not touching the signal output end and the Test Piece to avoid causing hazard.

1.7 Machine failure

Stop using the instrument immediately when finding it is operating abnormally, such as significant difference is existed between the current displayed on the current meter and the design value; or the current is not supplied, but the overlapping current indicator remains illuminated continuously. In this case, please contact us or your dealer to provide technical support.

1.8 Ending the test

When not using the instrument, please shut off the Power Switch. To restart the Power Switch after being disconnected, please wait for few seconds; however, do not execute consecutive on/off action of the power.

1.9 Installation, storage

Normal operating temperature and humidity scope of the instrument is 5oC~40oC and 80% RH respectively, and the instrument may act abnormally if exceeding such range. The storage temperature and humidity scope of the instrument is -20oC~ 70oC and 80% RH respectively. To achieve correct testing and to protect safety, do not install the instrument in the environment exposing to direct sunshine or high temperature, high humidity, frequency oscillation and rich dust.

1.10 Emergency treatment

Upon the occurrence of electrocution, burning of the Test Piece or the burning of Main Unit, please disconnect the Power Switch and remove the power cord plug immediately to avoid causing a hazard.

1.11 General instructions

- Do not place any combustible or heavy object on the instrument.
- Avoid heavy impact that may damage the machine.
- When cleaning the instrument, remove the power plug first and then wipe with the soft cloth soaked with mild cleanser and fresh water.
- If the instrument presents any Tolerance sign, do not attempt to dismantle it for making repairs; instead, send the instrument to our professional maintenance personnel for solving the problem.

2. Preface

In this chapter, we briefly introduce the characters, key features and specifications of 9030 Precision Impedance Analyzer.

2.1 Introduction

The test frequency of the MCR-9000 Precision Impedance Analyzer is DC 10Hz-30MHz and the test signal is 10mV-2Vrms (min. resolution 1mV), and is suitable for the LCR and DCR testes of AC signals. The measurement in a continuously changing environment can be executed stage-by-stage with the test frequency and grade, and high-speed continuous tests can be performed under different test and mode conditions. The machine also supports LAN, USB and GPIB PC connection capabilities to improve the design and test efficiency significantly. MATRIX MCR-9000 Impedance Analyzer also provides fixtures for material dielectric permittivity measurement that allows PCB designed engineers to reduce the faulty conditions with the comprehensive information of permittivity while designing PCB layouts.

The performance, convenience and operation flexibility of the Precision Impedance Analyzer have become indispensable tools for the professional measuring technicians. In addition to providing full-range solutions for the testing equipment over the past years, MATRIX also developed the new model of "9030 Precision Impedance Analyzer" that has contributed to more perfect precision solutions for the test. Such analyzer can meet customer demands for price, speed, capacity, accuracy and multi-function by its well-based flexibility in combination and implementation. Therefore, it can be used in the testing of a variety of components such as resistor, capacitor, inductor, oscillator, sensor, time-delay wire, filter and resonator.

2.2 Key Feature

- Signal source frequency range: DC, 10Hz ~ 5/10/20/30MHz
- Signal source grade: 10mV ~ 2V / 200 μ A ~ 20mA
- Basic accuracy up to $\pm 0.08\%$
- ALC function
- Output resistance 25 Ω /100 Ω , switchable
- Wide resistance measurement range from 25 m Ω to 40 M Ω (measurement accuracy up to 10%)
- Parameters: |Z|, |Y|, θ , R, X, G, B, L, C, D, Q, DCR, ESR, Vac, Iac, Vdc, Idc, etc.
- Ultra-high measuring speed
- Open circuit/short circuit/load calibration function
- Electric meter mode, multistep list mode, scan & analyze mode
- Up to four component parameters can be selected in the electric meter mode. The inductance and DCR values can be measured and displayed simultaneously
- Auto component classification: Comparator function and Handler BIN classification function
- Up to 32 sets of multistep list programs can be stored in the permanent memory and up to 16 test steps can be arranged in each program
- Rapid automation and data access function is realizable for USB, LAN, GPIB and RS232 interfaces
- PC connection data analysis software is available optionally
- 7" 800*480 TFT LCD color screen
- Ultra-light design: 344x145x343mm, 3kg

- Ultra-low power consumption (<30W) without fans and zero noise

2.3 Specification

9030 Precision Impedance Analyzer					
Models	Frequency range	Meter mode	List mode	Sweep mode	Equivalent circuit analysis
MCR-9030	10Hz~ 30MHz	√	√	√	
MCR-9020	10Hz~ 20MHz	√	√	√	
MCR-9010	10Hz~ 10MHz	√	√	√	
MCR-9005	10Hz~ 5MHz	√	√	√	
Resolution					
	100mHz, 6-bit Frequency Input				
Accuracy					
	7 ppm±100mHz				
Basic Accuracy					
	±0.08%				
Display Range	DCR		0.00mΩto99.9999MΩ		
	Z		0.000mΩto9999.99MΩ		
	R, X		±0.000mΩto9999.99MΩ		
	Y		0.00000μSto999.999kS		
	G, B		±0.00000μSto999.999kS		
	Cs, Cp		±0.00000pFto9999.99F		
	Ls, Lp		±0.00nHto9999.99kH		
	Q		0.00to9999.99		
	D		0.00000to9999.99		
	θ _{DEG}		±0.000°to180.000°		
	θ _{RAD}		±0.00000 to 3.14159		
	Δ%		±0.000%to999.999%		

Voltage Signal Level	Range	10mV~2Vrms
	Resolution	1mV
	Accuracy	
*f : frequency [MHz]	4-Terminal test fixture	$\pm [(10 + 0.05 \times f)\% + 1 \text{ mV}]$
	Cable length > 0m	$\pm [(15 + 0.1 \times f)\% + 1 \text{ mV}]$
Current Signal Level	Range	200 μ A~ 20mA
	Resolution	10 μ A
	Accuracy	
	4-Terminal test fixture	
	at \leq 15MHz	$+ [10\% + 50 \mu\text{A}], - [(10 + 0.2 \times f^2)\% + 50 \mu\text{A}]$
at > 15MHz	$\pm [(10 + 0.3 \times f)\% + 50 \mu\text{A}]$	
Cable length > 0m		
at \leq 5MHz	$+ [10\% + 50 \mu\text{A}], - [(15 + 1.5 \times f^2)\% + 50 \mu\text{A}]$	
*f : frequency [MHz]	at > 15MHz	$\pm [(20 + 0.3 \times f)\% + 50 \mu\text{A}]$
Measurement Time	<3ms(The fastest)	
Output Resistance	25 Ω /100 Ω , switchable	
Parameter	Z 、 Y 、 θ 、X、R、G、B、L、D、Q、DCR、C、Vdc-I _{dc} 、ESR、 ϵ 、 μ	
Calibration	Open Circuit/ Short Circuit/Load Calibration	
Measurement Circuit	Series/Parallel	
Multi-steps Mode	50 setup groups (with each group containing 15 measuring steps)	
PCLINK CPK Equivalent Circuit Analysis	Option	
Flash Memory	100 LCR-measure Mode setup documents& 50 Multi-steps Mode setup	
USB Memory	LCR-measure Mode setup document、Multi-steps Mode setup document、BMP graphics、Test result data、Sweep Mode BMP graphics& result data	
Interface	I/O Interface	Handler
	USB、RS232	Parallel interface
	Serial interface	GPIB
Display	7.0" TFT, 800*480color screen	
Environment	10°C~40°C, \leq 80%RH	
Power Supply	Voltage	90~264Vac
	Frequency	47~63Hz
Power Consumption	Low power consumption: Maximum 30W (Nominal value)	
Dimension(W*H*D)	336x147x340mm	
Weight	3kg	

3. Description of Installation

Thank you for using MATRIX 9000 Precision Impedance Analyzer as your testing instrument. This Manual contains the detailed installation steps. To ensure personnel safety and to protect your equipment and data, please check if the following accessories are fully supplied before starting the installation.

3.1 Package & Equipment

Standard:

If you are missing the following standard accessories, please contact your purchase manufacturer before installation.

- 90XX Precision Impedance Analyzer x 1
- User's Guide USB memory x 1
- Power cord x 1
- MF-6019 High frequency DIP fixture x1

Optional:

- PC software
- MF-4001 (Kelvin Clip Leads with BNC Box)
- MF-3001A/B/C (BNC Test Leads)
- MF-6007 (Dielectric Material Test Fixture)
- MF-6008 (Magnetic Material Test Fixture)
- MF-6009 (Material Test Fixture)
- MF-600810 (Bottom Electrode SMD Test Fixture)
- MF-60011 (Bottom SMD Tweezers Test Leads)
- MF-60012 (Bottom SMD Test Fixture)

3.2 Description of function keys on front panel

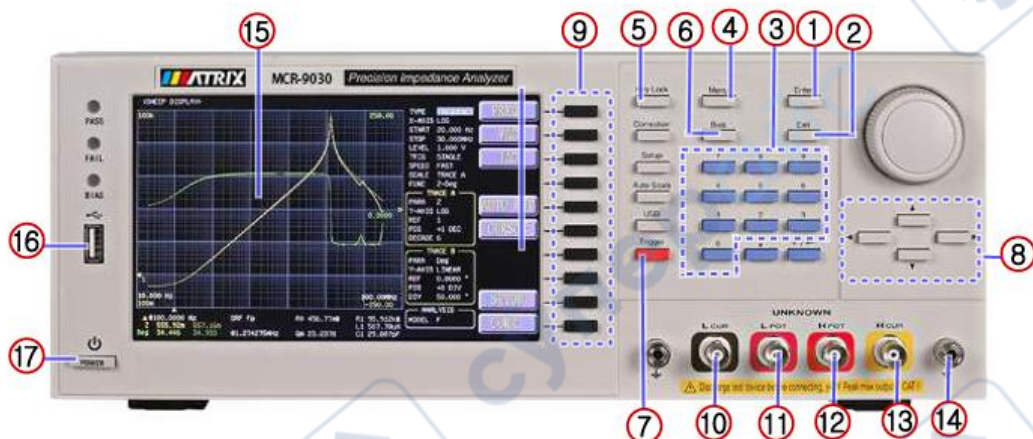

*Rear view (millimeters)

Push Key and Port	Function
1. Enter	Enter key
2. Exit	Exit key
3. Number key	Input value
4. Menu	For selecting Meter, Multi-step, Trace, Trim and System modes, etc.
5. Local	GPIB computer remote control wire. Such key will be locked to prevent from controlling the push key and the computer by both sides. To use the keypad again, press this key again.
6. Bias	For connecting the Bias unit and for executing on/off.
7. Trigger	For starting the test. When the instrument is under single-mode testing status, press "Trigger" to obtain the result of such test and the instrument will stop the testing action, waiting for next starting or other function change.
8. Direction	For selecting menu items. The "Up/Down/Left/Right" key set and control the cursor movement on the screen.
9. Function	For executing the function indicated for the position corresponding to the Function key.
10.LCUR (BNC)	BNC terminal
11.LPOT (BNC)	
12.H POT (BNC)	
13.H CUR (BNC)	
14.Ground Terminal	Grounding
15.LCD	Display
16.USB	For accessing data and image.
17.Power	Power Switch

3.3 Description of function keys on back panel

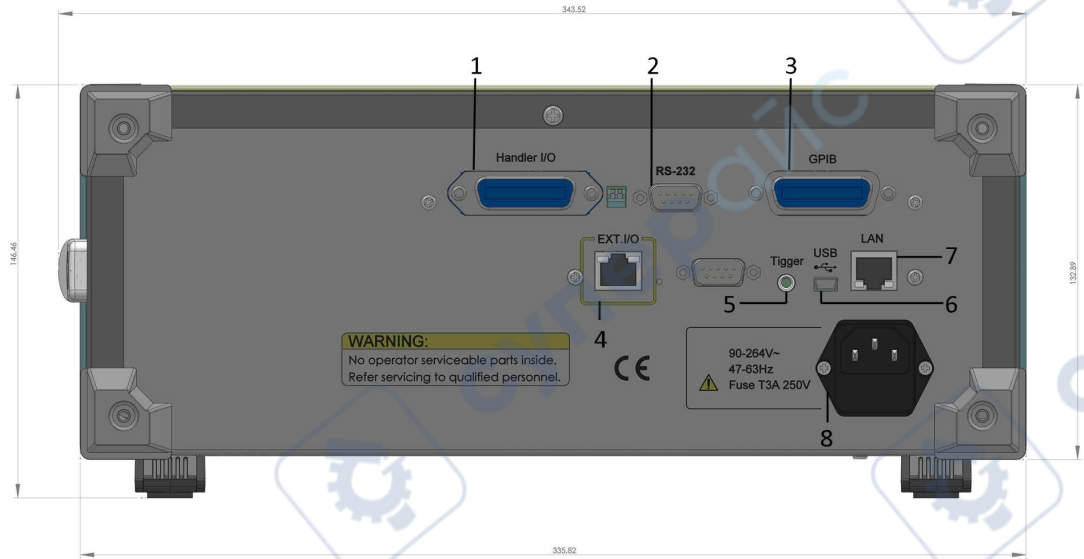

*Rear view (millimeters)

PORT	FUNCTION
1. Handler	Pass/Fail signal (see 3.4.3 Hander Interface)
2. RS232	For connecting to software port(see 3.4.2 RS232 Connecting)
3. GPIB	Remote control port: 24-pin block (see 3.4.1 GPIB Connecting)
4. EXT. I/O	For expanding Bias Input/Output port
5. Trigger	Pedal Switch port
6. USB	For software copying and upgrading
7. LAN	Network port
8. Power jack Fuseblock	AC power for 90~264V / 47~63Hz The fuse block contains input power fuse T3A/250V

3.4 Hardware Installation

3.4.1 GPIB Connecting

The computer and the measuring instrument are connected with GPIB (General-Purpose Interface Bus) cable, and the Test Piece will be tested or trimmed on the computer through GPIB.

- Definition of GPIB Pin



Pin	Definition	Pin	Definition
1	Dataline1	13	Dataline5
2	Dataline2	14	Dataline6
3	Dataline3	15	Dataline7
4	Dataline4	16	Dataline8
5	EOI	17	REN
6	DAV	18	Ground
7	NRFD	19	Ground
8	NDAC	20	Ground
9	IFC	21	Ground
10	SRQ	22	Ground
11	ATN	23	Ground
12	Shield	24	Signalground

Restrictions of GPIB:

1. At most, 15 units of equipment can be connected at the same time. The total length of connecting cable will be 20m, and the connecting cable between each equipment is 2m long.
2. Each piece of equipment will be allocated with a specific position.
3. Min. 2/3 of equipment will be operating.
4. The equipment will be connected by non-loop or parallel method.

3.4.2 RS232 Connecting

The computer and the measuring instrument are connected through RS232, and the Test Piece will be tested or trimmed on the computer through RS232.

- Definition of RS232Pin

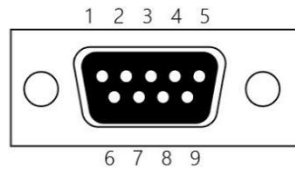

Pin	Definition	Pin	Definition
1	Non-connection	6	Non-connection
2	RXD (receiving data)	7	Non-connection
3	TXD (transmitting data)	8	Non-connection
4	Non-connection	9	Non-connection
5	GND		

3.4.3 Handler Interface

You may control the test function of your machine with an external signal through the Handler Interface and Handler I/O port in its back panel.

Please set the Handler Interface ON in SYSTEM menu to enable remote control and set the dip switch to on (both switches are pull down).

- Pins in Handler I/O port:

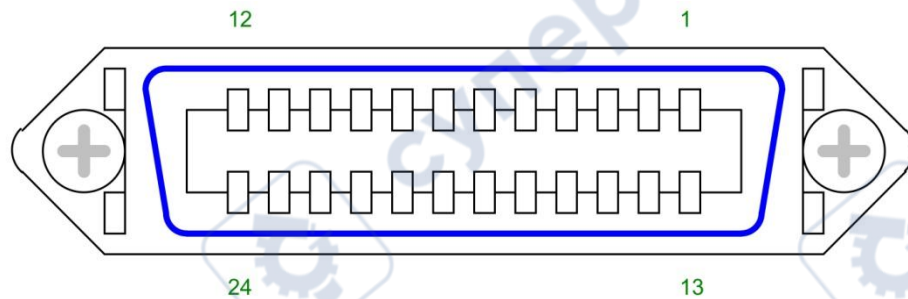

PIN #	Signal Name			Logic	Function Description
	Meter mode	List mode	Meter/List mode		
	(BIN off)		(BIN on)		
1	/EXT_TRIG			I Negative, Edge	External trigger signal, pulse width $\geq 100 \mu s$
2	/EOM			O Negative, Level	"End of all measurement" signal
3	/PASS			O Negative, Level	Pass signal of comparator
4	/FAIL			O Negative, Level	Fail signal of comparator
5	Trig Return			Signal Return	External Trigger Signal Return
6	COM			Common ground	Common ground of result signal
7	COM			Common ground	Common ground of result signal
8	--			--	
9	--			--	
10	+5V out			O DC_Power Out	+5V Supply, 100 mA max
11	--			--	
12	--			--	
13	/Ready			O Negative, Level	"Ready for trigger" signal
14	/Index			O Negative, Level	"End of analog measurement" signal
15	/PARA-1 OK	/STEP-1 OK	/BIN1	O Negative, Level	Comparator or Bin judgment result
16	/PARA-2 OK	/STEP-2 OK	/BIN2	O Negative, Level	Comparator or Bin judgment result
17	/PARA-3 OK	/STEP-3 OK	/BIN3	O Negative, Level	Comparator or Bin judgment result
18	/PARA-4 OK	/STEP-4 OK	/BIN4	O Negative, Level	Comparator or Bin judgment result
19	/PARA-1 NG	/STEP-1 NG	/BIN5	O Negative, Level	Comparator or Bin judgment result
20	/PARA-2 NG	/STEP-2 NG	/BIN6	O Negative, Level	Comparator or Bin judgment result
21	/PARA-3 NG	/STEP-3 NG	/BIN7	O Negative, Level	Comparator or Bin judgment result
22	/PARA-4 NG	/STEP-4 NG	/BIN8	O Negative, Level	Comparator or Bin judgment result
23	--	--	/BIN9	O Negative, Level	Bin judgment result
24	--	--	/BIN out	O Negative, Level	Out of BINs

- **Handler I/O timing diagram:**

{ Connections to Handler Interface Board }

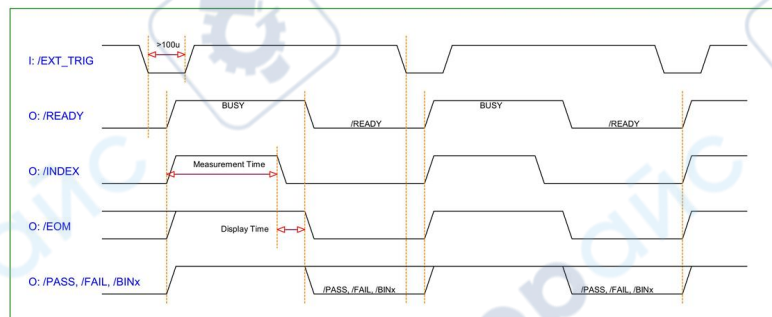
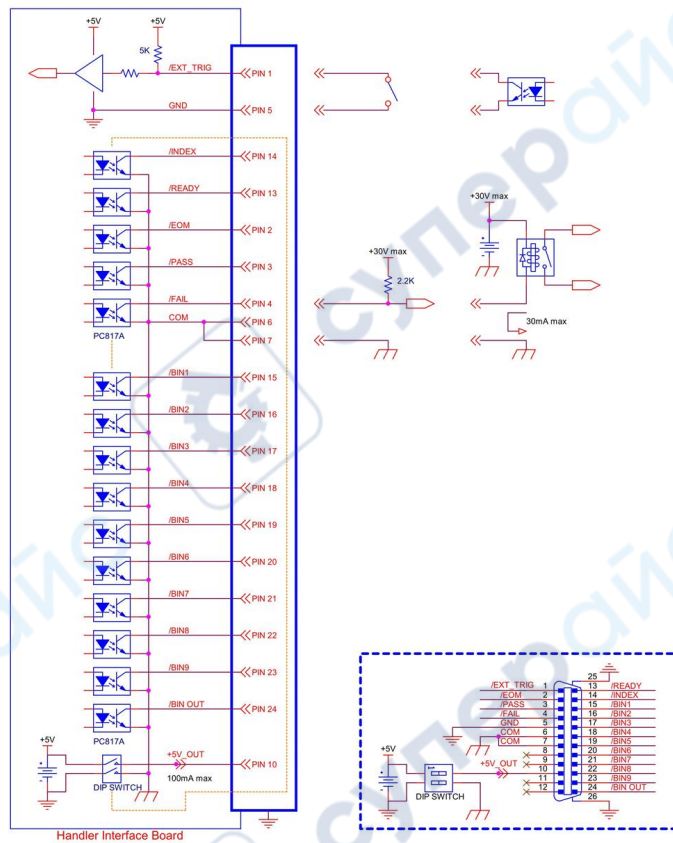

NOTE:

1. PIN1(trigger) + PIN5(gnd) Start testing after short circuit, the shorting time must be greater than 100uS.
2. The other output pins are photo coupler circuit, output signal is low level. The output is as a high resistance floating circuit when it without action.
3. /EOM and /INDEX will be clean after the /TRIGGER executed.

3.4.4 Fixture Connecting

When connecting the fixture, it is required to discharge the power of Test Piece thoroughly. Turn the latches on both sides of the fixture to left until aligning with the small protruding point on the BNC port. Push the fixture down to the end and then rotate the latch rightward for fixing the fixture. Next, execute O/C and S/C trimming (See [7. Correction](#)) and load the measured Test Piece in-between both locking plates on the fixture. Then fasten the screws to secure the Test Piece and the measuring process can be started.

3.4.5 LAN Port

The instrument will be connected to the LAN (Local Area Network) ports.

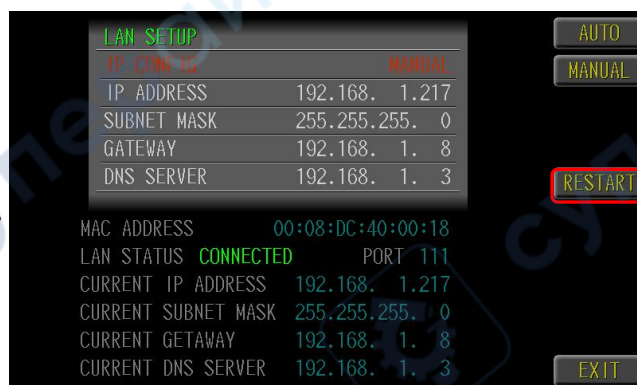
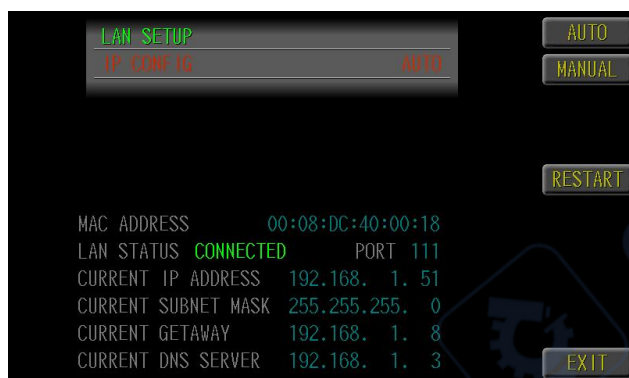

Can be selected as **Auto** or **Manual** settings and IP configuration

MAC ADDRESS: Sets the MAC address

LAN STATUS: Displays the current network connection status

PORT: Fixed as 111

CURRENT IP ADDRESS: The IP address of the instrument.

CURRENT SUBNET MASK: Sets the network subnet mask.

CURRENT GETAWAY: Sets the gateway

CURRENT DNS SERVER: Sets the DNS.

Manual requires entering of network

3.4.6 Power Cord Connecting

Connect the power cord to the power jack of the instrument. Turn on the Power Switch, and the instrument is ready for use.



Warning:

Before servicing the instrument, be sure to remove the power cord from the instrument. In addition, do not remove the plug when the hand is moistened as it may cause electrocution due to incorrect treatment. If the power cord or the power plug is damaged or loosened, it may cause the current leakage, burning, shorting or electrocution hazard.

4. Basic Measuring

4.1 Meter Mode

Press “Menu” key and then select “Meter” Mode for accessing the Meter Mode page.

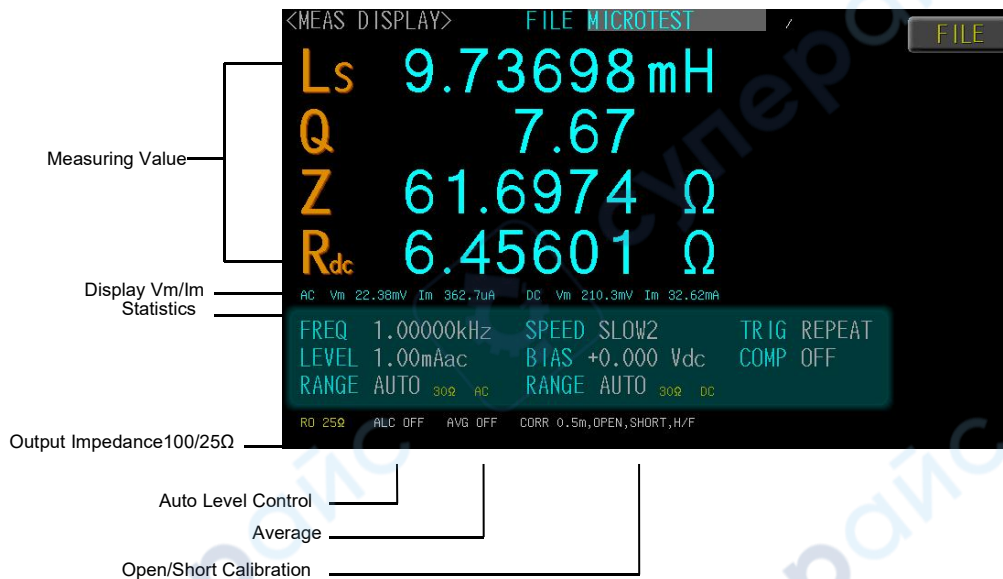

4.2 FREQ(Frequency)

The frequency range is 10Hz~30MHz, and the resolution is set at 6 digits. Press Input Digit key and then<Enter> to confirm the value or use the function key $\uparrow\uparrow\uparrow, \uparrow\uparrow, \uparrow, \downarrow, \downarrow\downarrow, \downarrow\downarrow\downarrow$ to adjust the frequency value by rough or minor adjusting method.

4.3 LEVEL

Select<Level> with<Direction> key. Press Input Digit key and then <Enter> to confirm the value for setting the signal level. The voltage range is 10mV~2Vrms, and the current range is 200 μ A~20mArms.

4.4 RANGE AC

Select<Range>with<Direction>key. It is preset as<Auto>. The measuring range belongs to internal parameter, which will be based to search the bay according to the measuring items. The range recommends setting as<Auto>in order to obtain better measuring accuracy. The range actually measured will be displayed at the lower-left corner of LCD panel. Further, there are also <1-30 Ω all frequency>, <2-300 Ω frequency below 1.2 MHz>, <3-3K Ω frequency below 120 KHz> and<4-30K Ω frequency below 12 KHz> ranges for option. Faster measuring speed can be achieved when setting at “Range Hold”.

4.5 SPEED

Select <SPEED> with <Direction> key. The <MAX.>, <FAST>, <MED.>, <SLOW> and <SLOW2> options are provided for the user to select according to their actual need.

4.6 BIAS

In setting the dc bias voltage, voltage range is $\pm 12\text{VDC}$, choose $\uparrow\uparrow, \uparrow, \downarrow, \downarrow\downarrow$. Adjust it or click the number key (when input is above the instrument voltage range will be displayed outside range)

4.7 RANGE DC

Select <Range> with <Direction> key. It is preset as <Auto>. The measuring range belongs to internal parameter, which will be based to search the bay according to the measuring items. The range recommends setting as <Auto> in order to obtain better measuring accuracy. The range actually measured will be displayed at the lower-left corner of LCD panel. Further, there are also <1-30 Ω all frequency>, <2-300 Ω frequency below 1.2 MHz>, <3-3K Ω frequency below 120 KHz> and <4-30K Ω frequency below 12 KHz> ranges for option. Faster measuring speed can be achieved when setting at "Range Hold".

4.8 TRIG

Use the <Up/Down> directional buttons to select. The options include <REPEAT> and <SINGLE>.

4.9 COMP

Use the <Up/Down> directional buttons to select. The options include <Compare category>.

4.10 Parameters

Press <Menu> key to select <Meter> mode and then move the cursor to the left side for setting the parameters to be measured.



Parameters	Definition
RDC	DC Resistance
Ls	Equivalent Series Inductance
Lp	Equivalent Parallel Inductance
Cs	Equivalent Series Capacitance
Cp	Equivalent Parallel Capacitance
Q	Quality Factor, (Q = 1/D)
D	Dissipation Factor, Loss coefficient (tanδ)
Rs	Equivalent Series Resistance (ESR)
Rp	Equivalent Parallel Resistance
Z	Absolute value of impedance
θ _{deg}	Phase angle of impedance(degree)
θ _{rad}	Phase angle of impedance(radian)
R	Resistance
X	Reactance
Y	Absolute value of admittance
G	Conductivity
B	Susceptance
ε _r	Relative Permittivity, Dielectric constant
μ _r	Relative Permeability

NOTE: When selecting parameter ε or μ, it is required to set ε_r and μ_r (see 4.10 SET ε_r and 4.11 SET μ_r)

4.11 MEASURER MODE SETUP

Press the **Setup** button on the instrument panel to enter the <MEASURE MODE SETUP> screen and perform measurement settings.

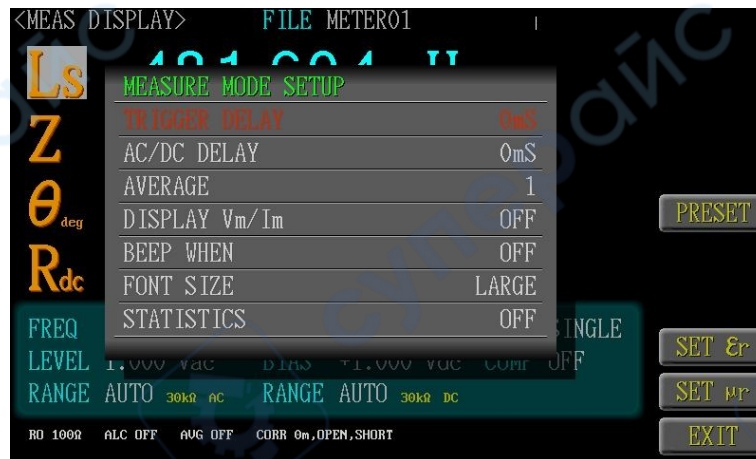
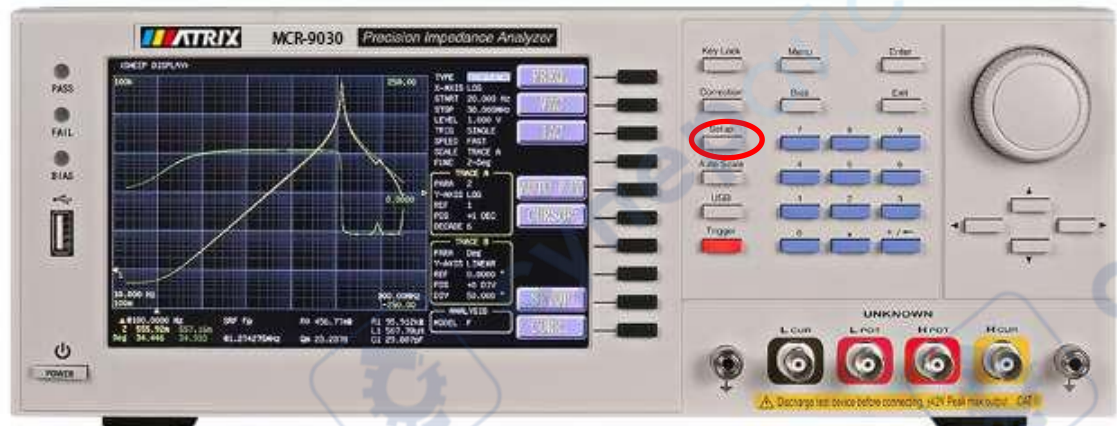

4.11.1 TRIGGER DELAY

Set the trigger delay time, and such function is normally used by the automated equipment.

NOTE:

The trigger delay time is set as 0-5000mS. If exceeding the high limit value, it will be adjusted back to 5000mS by the system automatically.

4.11.2 AC/DC DELAY

If AC parameter and RDC are included in the measuring, it can set the delay time between AC/DC measuring. This function is also suitable for when the measuring value of the Test Piece between AC/DC is instable.

4.11.3 AVERAGE

If the measuring value is instable, the average measuring count can be set within 1-64 times. The higher the average count, the steady the measuring value; on the contrary, the slower the measuring speed.

4.11.4 DISPLAY Vm/Im

It is preset as <No>. To display Vm/Im, then select <Yes> and the page will display the Vm/Im value of AC and DC. It recommend setting as <No> because it will affect the measuring speed.

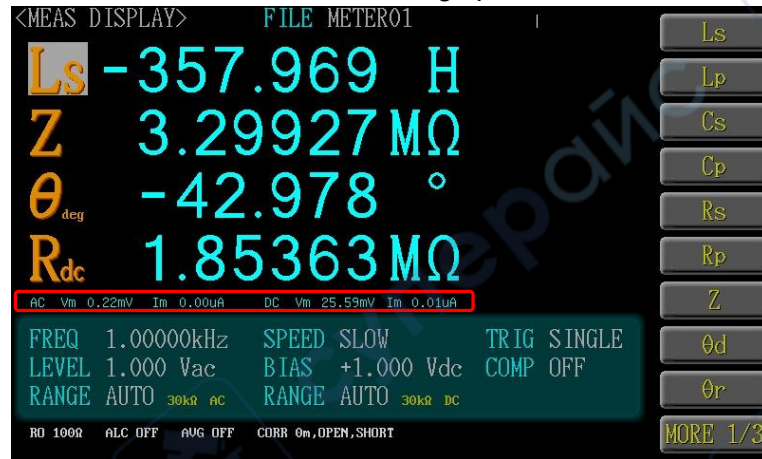

4.11.5 BEEP WHEN

It is preset as <OFF>. The <FAIL> option means that the fail beep will sound if the test result is judged as <FAIL>. The <PASS> option means that the pass beep will sound if the test result is judged as <PASS>.

4.11.6 STATISTICS

The default value is <Off>, option <ON> displays the statistics, option <CLEAR> clears the current statistics and option <PRESET> restores default factory settings.

4.11.7 FONT SIZE

It is preset as <LARGE>. Select <LARGE> or <SMALL> to change the font of the page.

4.12 TRIGGER MODE

Under the Meter Mode page, select <TRIG> with <Direction> key. It is preset as <REPEAT>, and the instrument will execute the measuring continuously. If selecting <SINGLE> option, then it must be activated by pressing <Trigger> key. The measuring will be repeated with each pressing of <Trigger> key.



4.13 LEVEL/RO/ALC

Under the Meter Mode page, select <LEVEL> with <Direction> key. Press Input Digit key and then <Enter> to confirm the value or use the function key ↑, ↓ to adjust the Level value. The AC voltage range is 10mV~2Vrms, and the current range is 200μA~20mArms. The ADC voltage range is 10mV~1Vrms, and the current range is 200μA~40mArms

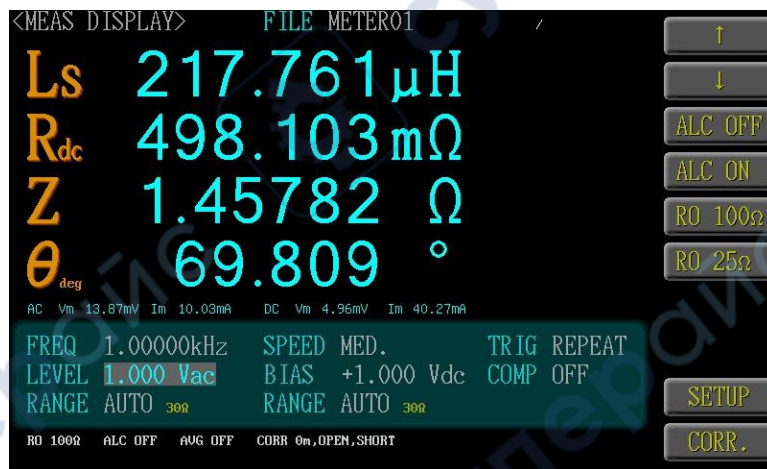

4.13.1 RO (Output Impedance)

The <100Ω> or <25Ω> can be selected according to the user's demand. The varied signal source output impedance will lead to the varied current or the difference of measuring value. If selecting <25Ω>, then the AC voltage range change to 10mV~1Vrms, and the current range is 200μA~40mArms.

4.13.2 ALC (Auto Level Control)



Display ALC ON

Display ALC Fail

It is preset as <ALC OFF>. If selecting <ALC ON>, it ensures that the voltage applied to both ends of Test Piece or the current flowing through the Test Piece will be consistent with the parameter set value. If selecting <ALC ON>, because the instrument needs to calculate the voltage and the current for adjusting the output, it will increase the time required for the measuring. If the Auto Level Control cannot achieve the range to be set, the page will display < ALC unable to regulate> message, and it recommend setting as <ALC OFF> because it will affect the measuring speed.

4.14 SET ϵ_r

Selected <SETUP> function key then selected <SET ϵ_r > function key to access the <DIELECTRIC CONSTANT SETUP> page for setting up ϵ_r .



4.15 Dielectric Coefficient Measurement Method

The <Contact> or <Non-contact> can be selected according to the tested material. If selecting the <Contact> measuring method, the user needs to set up the <DIAMETER> of polarity plate for the fixture and the <THICKNESS> of the tested material and <fixture correction coefficient>.

If selecting the <Non-contact> measuring method, the user needs to set up the <THICKNESS> of the tested material as well as the <GAP> between the polarity plate of the fixture and the <EMPTY CAPACITANCE> and <fixture correction coefficient>.

Fixture correction coefficient: This is the compensation parameter used for fixture Fx-0000c7 or Fx-000c20.



4.16 SET μ_r

Selected <SETUP> function key then selected <SET μ_r > function key to access the <PERMEABILITY SETUP> page.

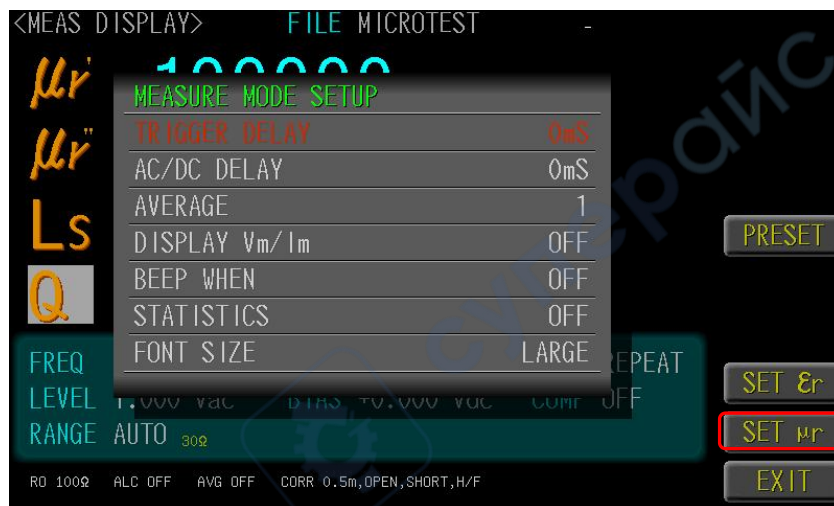

4.17 Magnetic Permeability Coefficient Measurement Method

For setting up the <HEIGHT>, <INNER DIAMETER> and <OUTER DIAMETER> of the tested material and <fixture correction coefficient>.

Fixture correction coefficient: This is the compensation parameter used for fixture Fx-0000C8.



4.18 COMP (Comparison)

Under the Meter Mode page, select <COMP> with <Direction> key to access the comparison setup page. It is preset as “No”. When selecting “Yes”, the high/low limit range must be set for using as the measuring setup of the production line or the automated process.



4.18.1 COMPARATOR SETUP

Preset a reference value and upper and lower limit values as the comparative reference, and display a comparative result as green font (measured value is between UPPER and LOWER), red font (measured value exceed UPPER and LOWER).

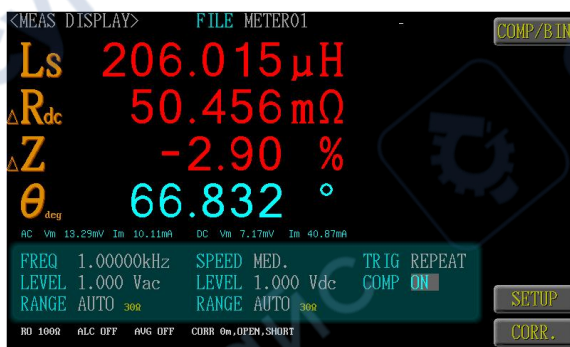

4.18.2 COMP (Comparator) MODE & DISP (Display) Mode

- ABS

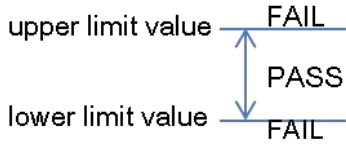
<p>Set absolute values for the upper limit and lower limit values of the measurement parameters. The measurement values displayed are the same of the measurement parameters.</p>

- Δ Abs

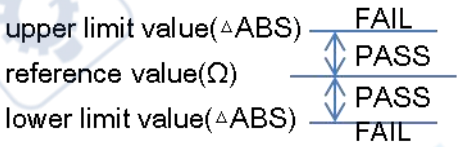
<p>Enter reference values and then set absolute values corresponding to the reference values as the upper limit and lower limit values. The measurement values displayed are displayed in deviations (ΔAbs) from the reference value. The following equation is used to calculate the comparison UPPER/LOWER value</p> <p>ΔAbs =</p> <p>The following equation is used to display ΔAbs mode</p> <p>ΔAbs =</p>

- Δ %

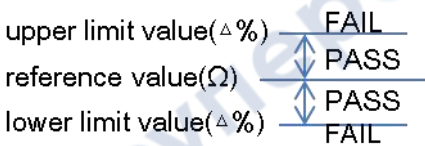
<p>Enter reference values and then set percentages corresponding to the reference values as the upper limit and lower limit values. The measurement values displayed are displayed in deviations (Δ%) from the reference value. The following equation is used to calculate and display Δ%</p> <p>Δ% =</p>

4.18.3 UPPER

The nominal value is used for executing the addition of Hi Limit.

4.18.4 LOWER

The nominal value is used for executing the subtraction of Lo Limit. If selecting “ Δ Abs” or “ $\Delta\%$ ”, then the user needs to key in the negative mark before inputting the digits for the negative tolerance.

4.19 BIN SETUP

Select <Bin> for setting the bin conditions of each parameter, including Bin class 2~9. The Bin Method comprises sequence, error, random, equalization; whereas, the Value Mode comprises the Measuring Value, Tolerance value and Tolerance %.

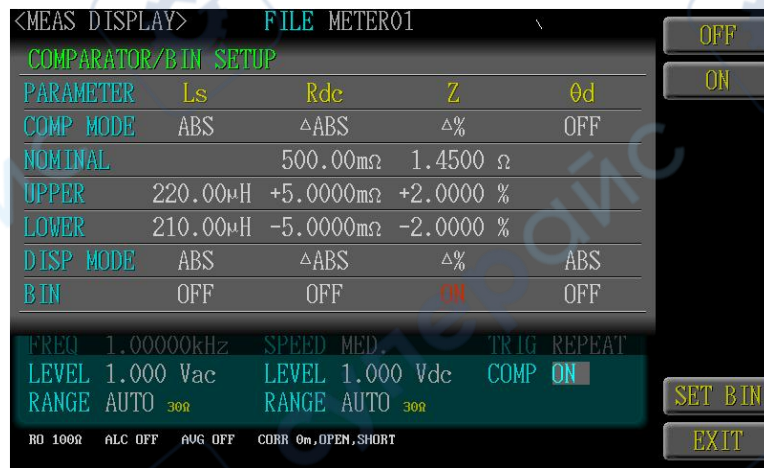

4.19.1 PARAMETER and BIN NUMBER

Select the parameter and display up to 9 classifications of judgment results.

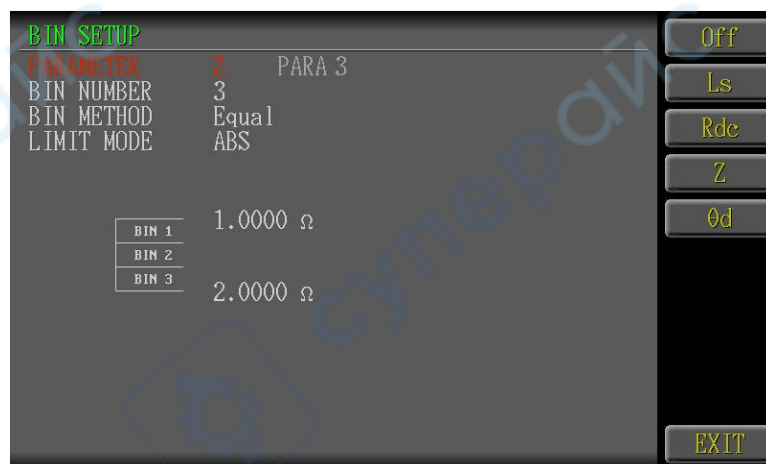

4.19.2 BIN METHOD

Equal: Set the upper and lower limit values for parameter, the Equal mode averages each the comparison values automatically. The Limit mode can select <ABS>, < Δ Abs> and < Δ %>.

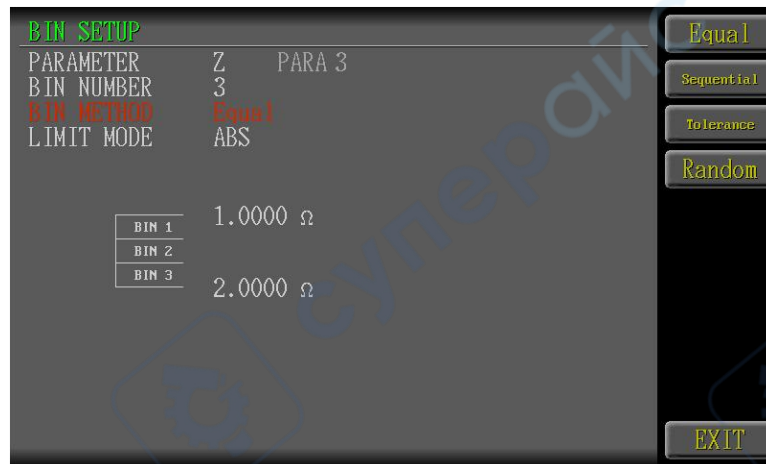

Sequential: The Sequential mode specifies comparison limits as the absolute measurement value. The Limit mode can select <ABS>, < Δ Abs> and < Δ %>.

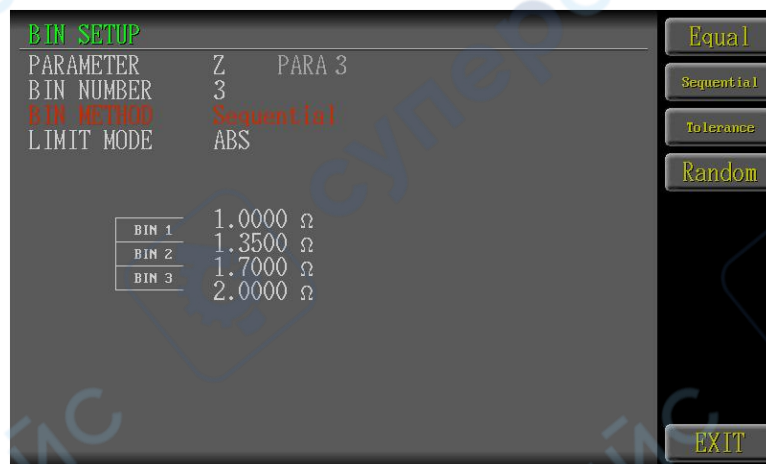

Tolerance: The tolerance mode specifies comparison limits by the deviation from the nominal value. The Limit mode can select < Δ Abs> and < Δ %>.

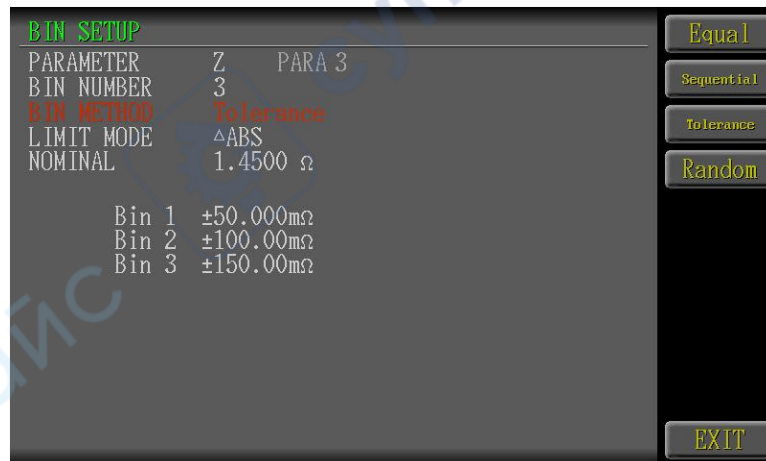

Random: Set the upper and lower limit values for each bin. The Limit mode can select <ABS>, < Δ Abs> and < Δ %>.



9030 uses three methods for specifying parameter limits as follows:

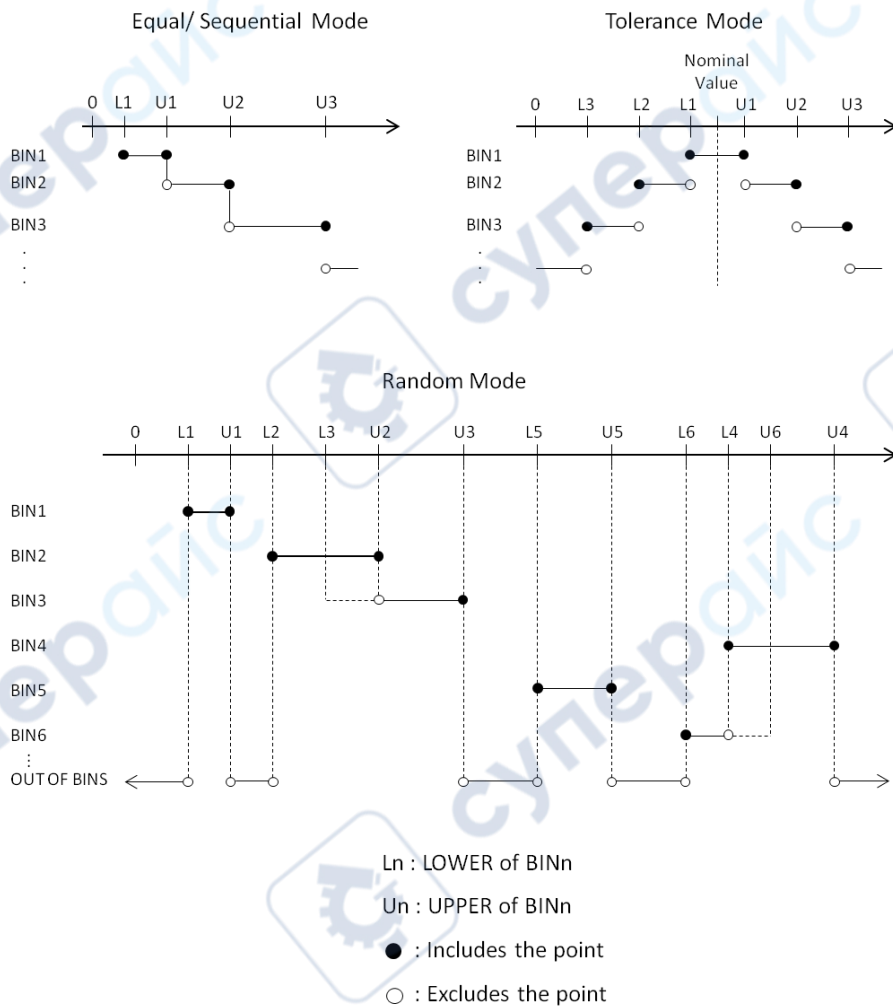

4.20 FILE

The parameter can be saved in the flash Memory of the instrument. The Meter Mode allows the user to access 100 setup groups, and the Multi-step List Test Mode allows the user to access 50 setup groups (with each group containing 15 measuring steps).

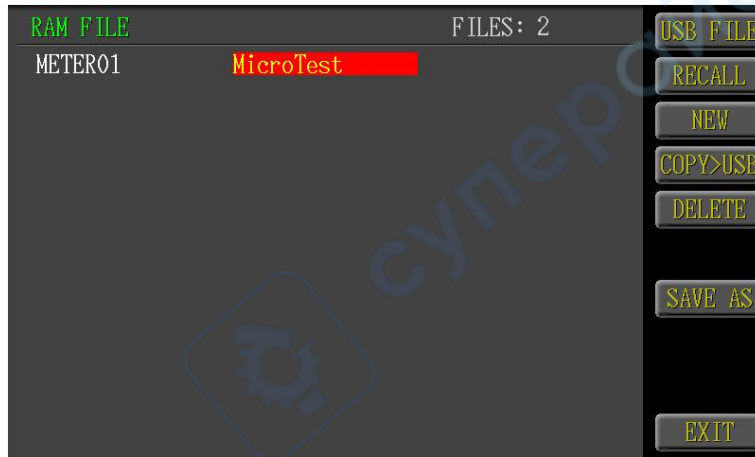

4.20.1 RECAL

After selecting the file to be opened with <Direction> key, click <Open> function key and you can enter the file.

4.20.2 NEW

Select <New> function key and the user can set up an empty file. After setting the file name, press <OK> and return to the Main Page for proceeding with the parameter setup.

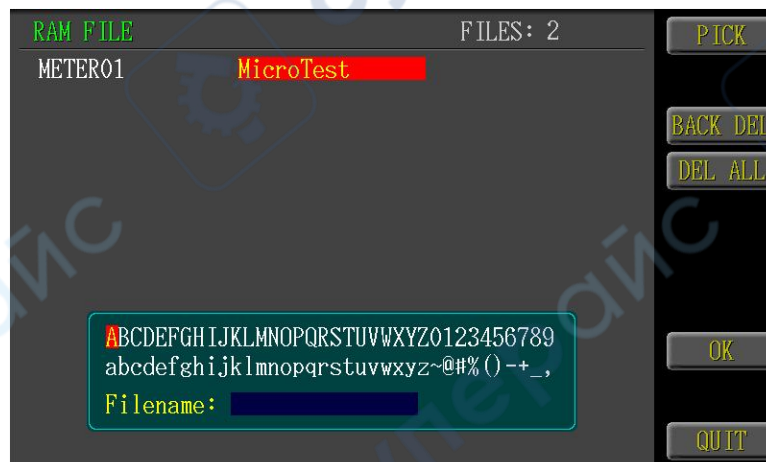

4.20.3 SAVE AS

After setting the parameter, select <Save As> function key and set the file name. Next, press <OK> and the parameter setup can be saved in the new file.

4.20.4 DELETE

Select <DELETE> function key to delete the file, the file which is being used cannot delete.

4.20.5 USB FILE

Insert the USB flash drive into the USB port on the front panel of the instrument, Select<USB FILE> function key to access the USB IA9030 folder.

4.20.6 COPY>USB

Insert the USB flash drive into the USB port on the front panel of the instrument, Select<COPY>USB> to copy 9030 local file to USB flash drive.

NOTE:

1. The METER mode setting file is saved to USB flash drive root IA9030-->METER.
2. The Multi-steps mode setting file is saved to USB flash drive root IA9030-->LIST.
3. It can only use <SAVE SCREEN>to save the METER mode and the Multi-steps mode's test result as BMP (graphics) file, the .bmp file is saved to USB flash drive root IA9030-->SCREEN.
4. The SWEEP mode measurement data and screen graphics is save to USB flash drive root-->SWEEP

5. LIST TEST

Press <Menu> key and select <LIST SET> for executing the multi-step setup. The measurement frequency or measurement signal level differs for each panel allows you to simply evaluate the characteristics of the DUT. Such function can be used in the production line or the automation test and, at most, 15 testing steps can be set.

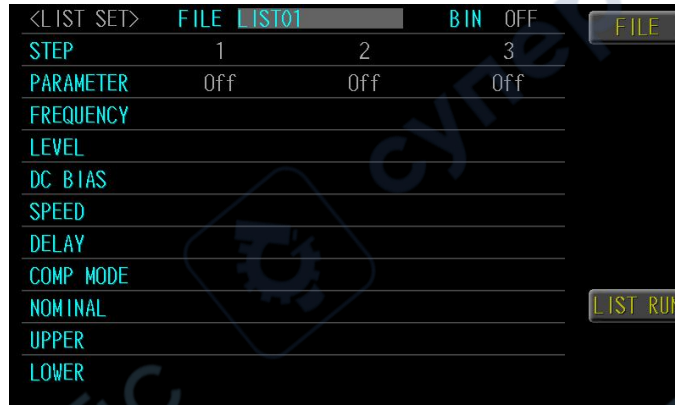

<LIST SET>	FILE	LIST01	BIN	OFF
STEP	1	2	3	
PARAMETER	Off	Off	Off	
FREQUENCY				
LEVEL				
DC BIAS				
SPEED				
DELAY				
COMP MODE				
NOMINAL				
UPPER				
LOWER				

5.1 LIST SET

Select <LIST SET> function key. Press left/right <Direction> key to select Step 1~15 STEP, and press up/down <Direction> key to select PARAMETER, FREQUENCY, LEVEL, DC BIAS, SPEED, DELAY, COMP MODE, NOMINAL, UPPER and LOWER. After being set, select <List Run> key to access multi-step testing page.

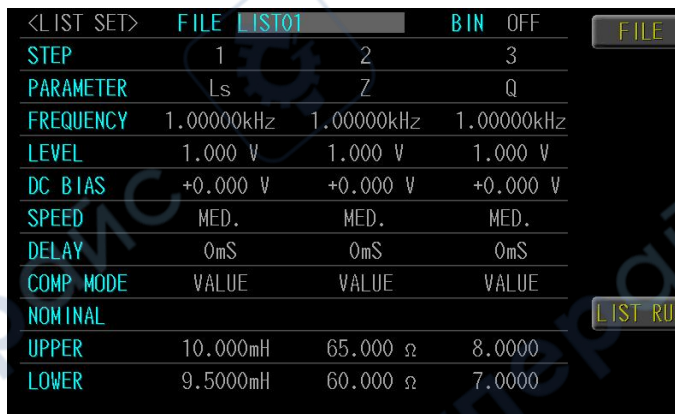

<LIST SET>	FILE	LIST01	BIN	OFF
STEP	1	2	3	
PARAMETER	Ls	Z	Q	
FREQUENCY	1.00000kHz	1.00000kHz	1.00000kHz	
LEVEL	1.000 V	1.000 V	1.000 V	
DC BIAS	+0.000 V	+0.000 V	+0.000 V	
SPEED	MED.	MED.	MED.	
DELAY	0mS	0mS	0mS	
COMP MODE	VALUE	VALUE	VALUE	
NOMINAL				
UPPER	10.000mH	65.000 Ω	8.0000	
LOWER	9.5000mH	60.000 Ω	7.0000	

5.2 LIST MODE SETUP

Under the <LIST SET> or <LIST RUN> page, selected <SETUP> function key and you can access the <LIST MODE SETUP> page for executing the measuring setup.

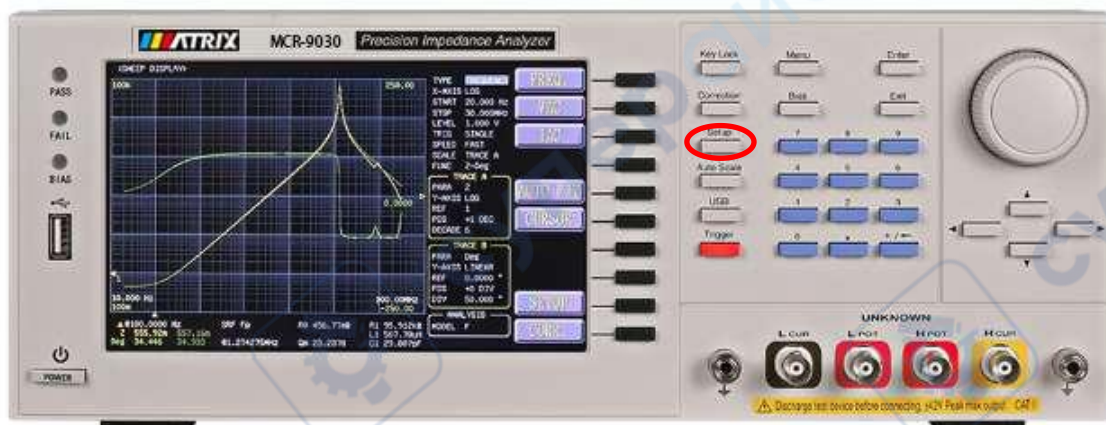

<LIST SET> FILE LIST01		BIN	OFF	REPEAT
STEP	LIST MODE SETUP		3	SINGLE
PARAME	TRIGGER MODE	SINGLE	Q	AUTO
FREQUE	TRIGGER DELAY	0mS	000kHz	PRESET
LEVEL	AUTO TRIG THRESHOLD		000 V	
DC BIA	OUTPUT IMPEDANCE	100Ω	000 V	
SPEED	ALC	OFF	ED.	
DELAY	BEEP WHEN	OFF	0mS	
COMP M	RANGE HOLD	OFF	VALUE	
NOMINA	FAIL RETEST	OFF		
UPPER	STATISTICS	OFF	0000	
LOWER	TERMINATED AT NG STEP	OFF	0000	EXIT

5.2.1 TRIGGER MODE

It <REPEAT><SINGLE><AUTO> three different types of trigger can be set. Selecting <REPEAT> option, the instrument will execute the measuring continuously. Selecting <SINGLE> option, it must be activated by pressing <Trigger> key (signal), the measuring will be repeated with each pressing of <Trigger> key (signal). Selecting <AUTO> option, the measuring will start automatically, when the DUT measuring circuit connects incorrect.

5.2.2 TRIGGER DELAY

Set the trigger delay time, and such function is normally used by the automated equipment.

NOTE: The trigger delay time is set as 0-5000mS. If exceeding the high limit value, it will be adjusted back to 5000mS by the system automatically.

5.2.3 Automatic trigger determination point mode

Sets the trigger mode as automatic detection; the automatic trigger determination can be set from 0.01uA ~ 20000.00uA as the trigger determination point.

When the value is greater than the determination point, it means that the DUT has been connected; when the value is less than the determination point, it means that the DUT has been disconnected.

5.2.4 OUTPUT IMPEDANCE

The <100Ω> or <25Ω> can be selected according to the user's demand. The varied signal source output impedance will lead to the varied current or the difference of measuring value. If selecting <25Ω>, then the AC voltage range change to 10mV~1Vrms, and the current range is 200μA~40mA_{rms}.

5.2.5 ALC

It is preset as <ALC OFF>. If selecting <ALC ON>, it ensures that the voltage applied to both ends of Test Piece or the current flowing through the Test Piece will be consistent with the parameter set value. If selecting <ALC ON>, because the instrument needs to calculate the voltage and the current for adjusting the output, it will increase the time required for the measuring. If the Auto Level Control cannot achieve the range to be set, the page will display <ALC FAIL> at the lower-right corner of panel, and it recommend setting as <ALC OFF> because it will affect the measuring speed.



5.2.6 BEEP WHEN

It is preset as <OFF>. The <FAIL> option means that the fail beep will sound if the test result is judged as <FAIL>. The <PASS> option means that the pass beep will sound if the test result is judged as <PASS>.

5.2.7 RANGE HOLD

It is preset as <ON>. If selecting <ON>, the measuring range is hold at the range, which is used by the first time measuring. If selecting <OFF>, the most suitable test range is set automatically. Faster measuring speed can be achieved when setting at <ON>.

5.2.8 FAIL RETSET

It is preset as <OFF>. It retest continuously until the test result is pass, when the test result is fail. If selecting <OFF>, it doesn't execute this

function. If selecting <STEP 1>, only the first step is going to retest. If selecting <ALL>, no matter which step occur fail result, the fail step is going to retest until the result become pass.

5.2.9 STATISTICS

Whether to enable the result statistics function located at the bottom-right corner; <Clear> will reset all PASS and FAIL statistics and continuing keeping statistics all over again.

5.2.10 TERMINATED AT NG STEP

When TERMINATED AT NG STEP is set as <ON>, the test will be terminated when any NG is detected during testing.

5.2.11 PRESET

It resets the LIST file as a new List file, all of the steps are deleted. <TRIGGER MODE:SINGLE>;<TRIGGER DELAY:0mS>;<OUTPUT IMPEDANCE:100>;<ALC:OFF>;<BEEP WHEN:OFF>;<RANGE HOLD:ON>;<FAIL RETEST:OFF>;<STATISTICS:OFF>.

5.3 CORR.(LIST CORRECTION)

Under the LIST SET or LIST RUN page, list correction and meter correction are not the synchronize function. It suggests doing List Correction when starting multi-step testing at the first time or changing any List setup value.

6. SWEEP

Press <Menu> key and select <Sweep> Mode for entering the Sweep Mode page. The Sweep Mode displays the component characteristics by visual method and the user can select voltage, current and frequency sweeping for using as the horizontal coordinates. If the sweeping result exceeds the vertical range, then the instrument will adjust the scale automatically; further, more suitable measuring can be achieved with the use of the cursor.

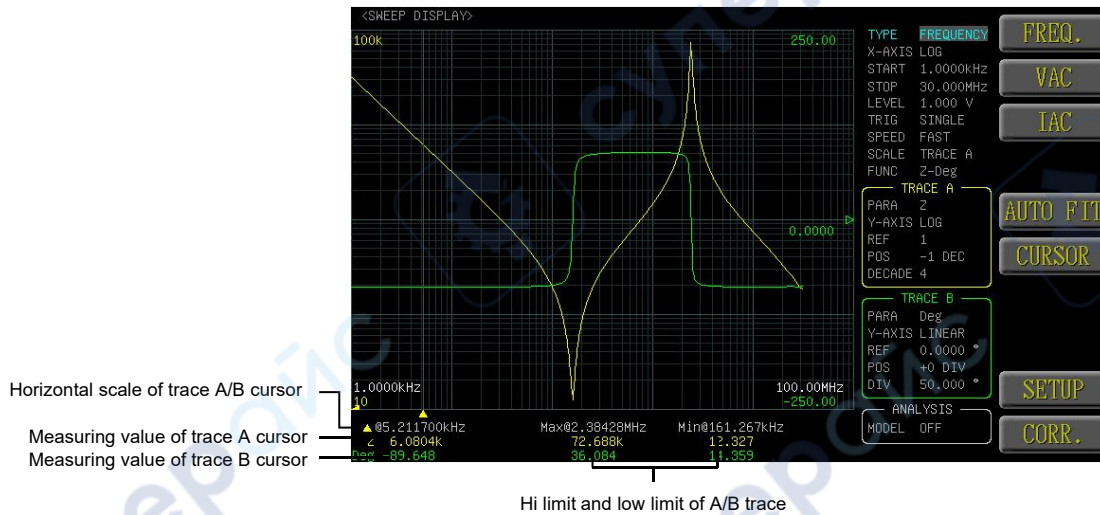

6.1 SWEEP MODE SETUP

Under the Sweep mode page, select <SETUP> function key for accessing the SWEEP MODE SETUP page.

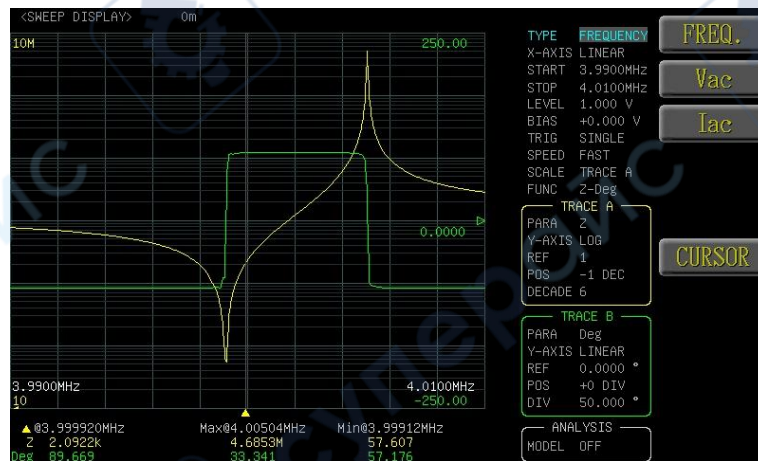

6.1.1 SWEEP DELAY

The delay time between each sweeping point can be set according to the user's need. When set at Sweep Delay Mode, it will affect the entire measuring time.

NOTE: The trigger delay time is set as 0-5000mS. If exceeding the high limit value, it will be adjusted back to 5000mS by the system automatically.

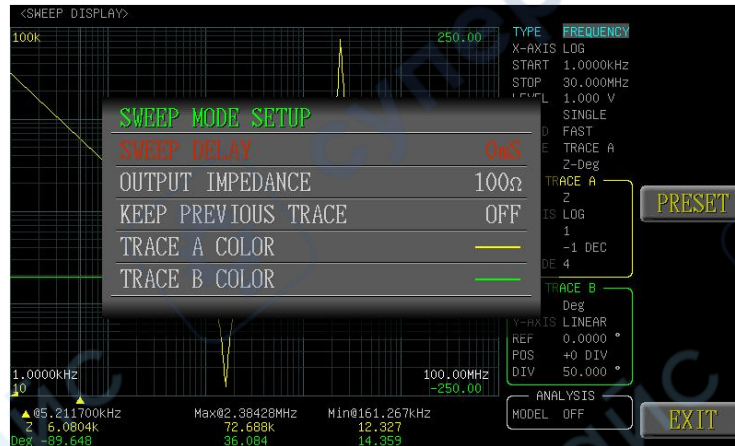

6.1.2 OUTPUT IMPEDANCE

The <100Ω> or <25Ω> can be selected according to the user's demand. The varied signal source output impedance will lead to the varied current or the difference of measuring value. If selecting <25Ω>, then the AC voltage range change to 10mV~1Vrms, and the current range is 200μA~40mArms.

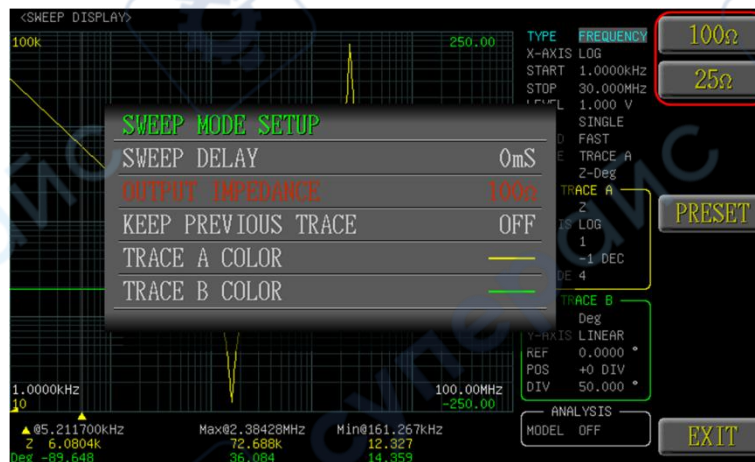

6.1.3 KEEP PREVIOUS TRACE

When <KEEP PREVIOUS TRACE> is selected <ON>, the graph drawn for the last sweeping remains and is overwritten with a brighter graph for the most recent measurement results.

When <KEEP PREVIOUS TRACE> is selected <OFF>, the graph drawn for the last measurement is deleted and a graph for the most recent sweeping results is drawn.

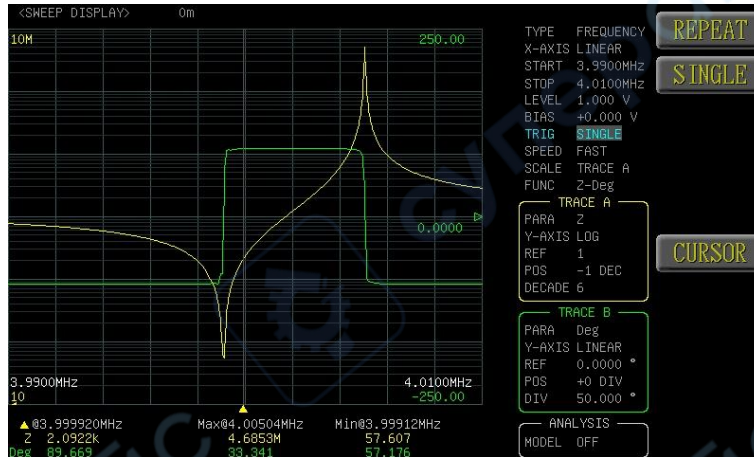

6.1.4 TRACE A/B COLOR

Use the <COLOR -> and <COLOR +>function key to set the color of trace A/B.

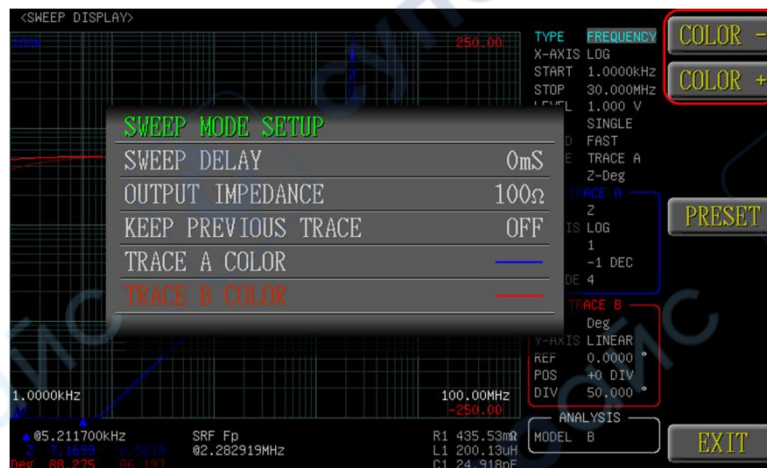

6.1.5 PRESET

It resets the Sweep mode setup. <TYPE-FREQUENCY>; <XAXIS-LOG>; <START-20Hz>; <STOP-3/5/10/20/30MHz>; <LEVEL-1V>; <TRIG-SINGLE>; <SPEED-FAST>; <SCALE-TRACE A>; <FUNC-Z-DEG>; <SWEEP DELAY-0mS>; <OUTPUT IMPENANCE-100Ω>; <KEEP PREVIOUS TRACE-OFF>; <TRACE A COLOR-yellow>; <TRACE B COLOR-green>.

6.1.6 CURSOR

The <CURSOR> function can easily find the maximum value, minimum value, and self-resonant frequency parallel/serial, then the searching result will be displayed at the lower-middle of LCD panel.

<TrA MAX: traceA's maximum value>, <TrA MIN: traceA's minimum value>, <TrB MAX: traceB's maximum value>, <TrB MIN: traceB's minimum value>, <SRF fs: self-resonant frequency serial>, <SRF fp: self-resonant frequency parallel>

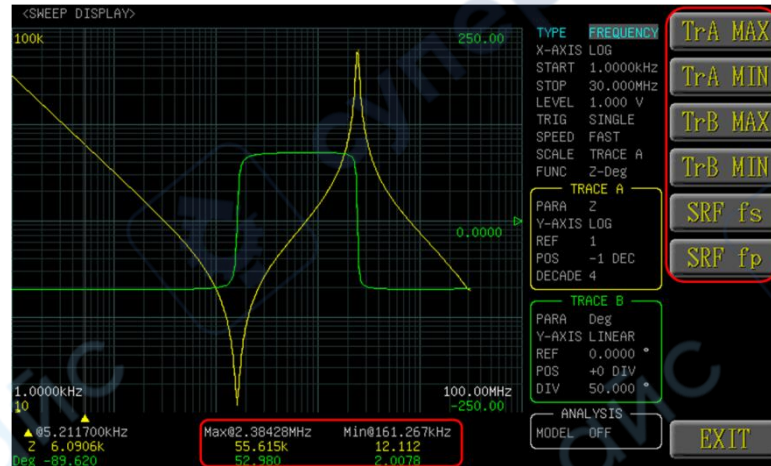

6.1.7 AUTO FIT

If the sweeping result exceeds the vertical range, then press <AUTO FIT> key to adjust the sweeping graph automatically.

6.1.8 TYPE

It is preset as <FREQUENCY>. Use <Direction> key and the user can switch to <VAC: Voltage> or <IAC: Current>.

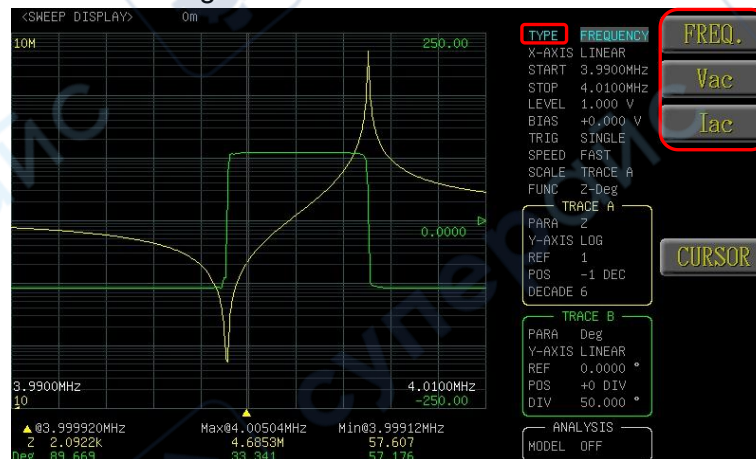

6.1.9 X-AXIS

The <X-AXIS> can be set as <LINEAR> or <LOG>. The Linear Mode is divided into 250 equal portions with starting and ending values, and the Log Mode changes along with the set value.

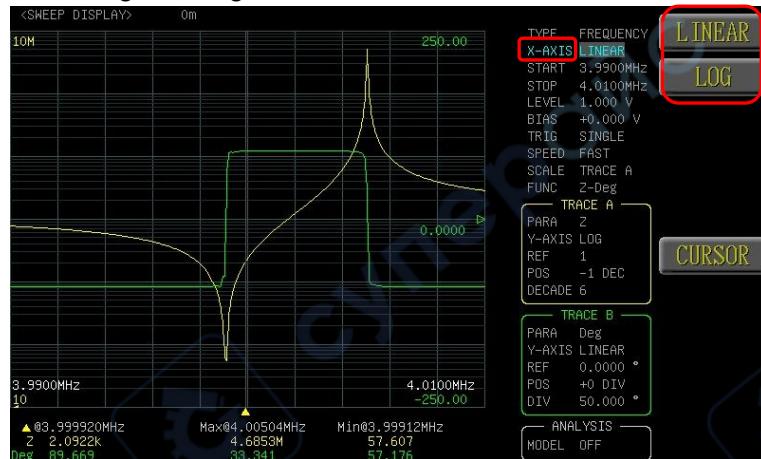

6.1.10 START/STOP

<START>Use the numeric keypad to set the starting value of the sweep.

<STOP>Use the numeric keypad to set the ending value of the sweep.

6.1.11 LEVEL

Under the frequency sweep type, it can set the measurement voltage or measurement current.

Under the voltage/current sweep type, it can set the measurement frequency.

6.1.12 TRIG

It <REPEAT><SINGLE> two different types of trigger can be set. Selecting <REPEAT> option, sweeping can be repeated unlimited time after you press <Trigger> key (signal). Selecting <SINGLE> option, it must be activated by pressing <Trigger> key (signal), the sweeping will be repeated with each pressing of <Trigger> key (signal).

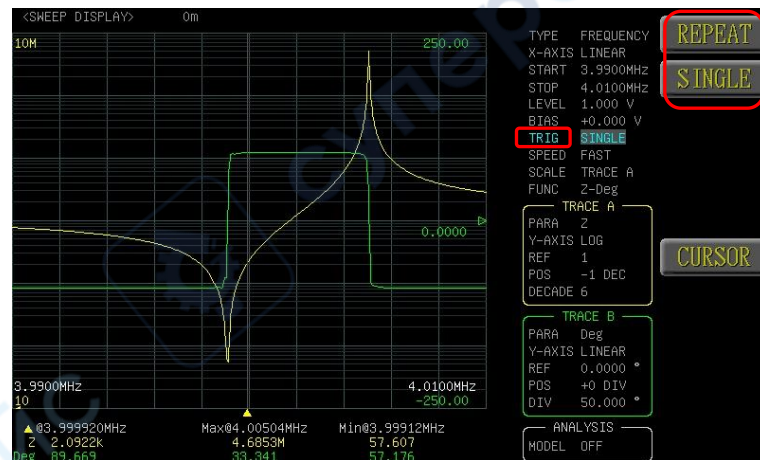

6.1.13 SPEED

The sweep speed is available in "Fast", "Medium" and "Slow" for option.

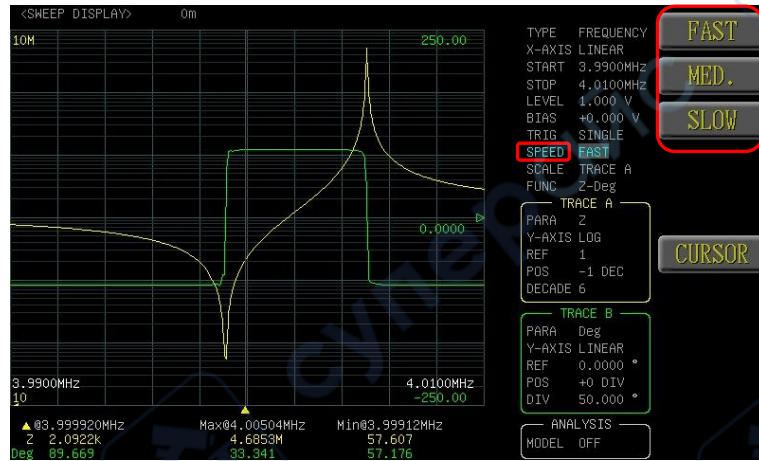

6.1.14 FUNC

It can select default common parameter sets.

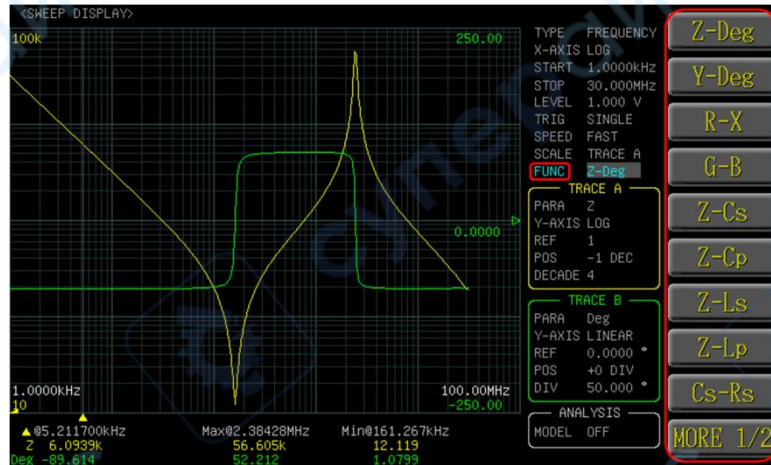

6.1.15 TRACE A/B PARA

It sets the parameters to be analyzed

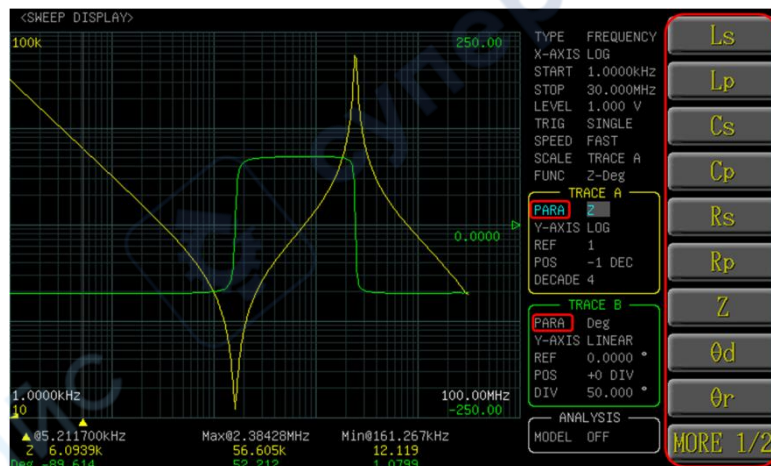

6.1.16 TRACE A/B Y-AXIS

The Y-AXIS can be set as "Linear" or "Log."



6.1.17 TRACE A/B REF

When <Y-AXIS> is selected <LINEAR> type, it can change values of the reference line by using numeric keypad.

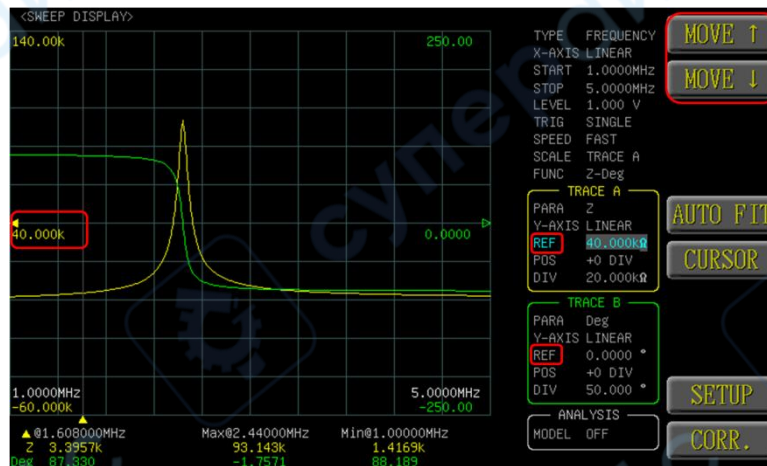

6.1.18 TRACE A/B POS

Moving trace A/B up or down by using <move↑> and <move↓>.



6.1.19 TRACE A/B DIV/DECADE

Adjusting trace A/B's amplitude size by using <ZOOM-> and <ZOOM+>. When <LINEAR> type is selected at Y-AXIS, <DIV> is set. When <LOG> type is selected at Y-AXIS, <DECADE> is set.

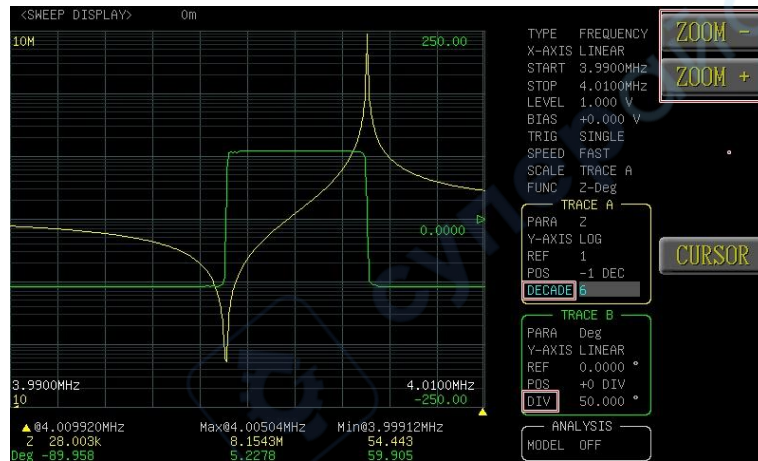

6.2 Equivalent Circuit Analysis (option)

The equivalent circuit analysis function estimates equivalent circuit constants based on measurement results. The 9030 can estimate 3-element model and 4-element model. By using the simulation function, you can display frequency characteristic ideal values using estimation results or user-configured constants.



self-resonant frequency

equivalent circuit values

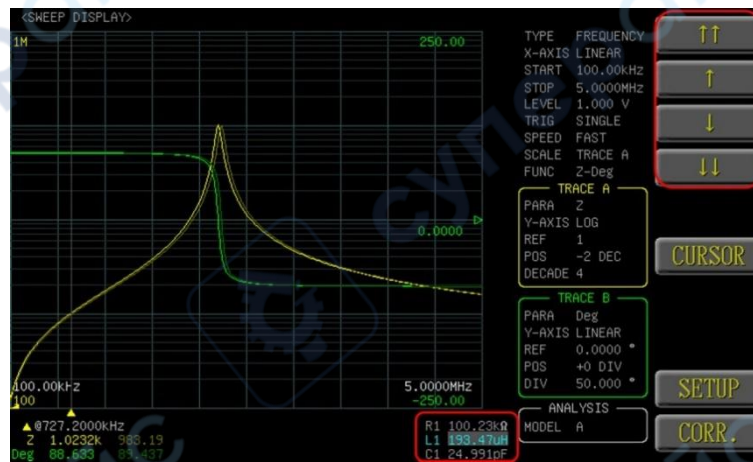

Use <mode-> and <mode+> function key to set the equivalent circuit type. Move the cursor to the equivalent circuit values; you can enter the desired value with numeric keypad or use <↑↑>, <↑>, <↓> and <↓↓> to do the fine adjustment, then you can simulate the equivalent circuit.

Equivalent Circuit Model	Typical Frequency Characteristics	Dut Example
<p>A</p>		<p>Inductor: Inductor with high core loss and low ESR</p>

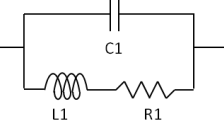
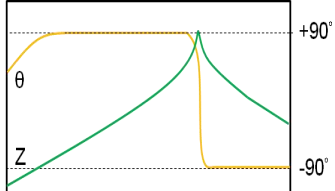
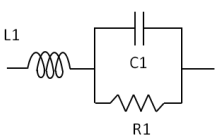
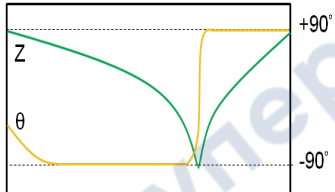
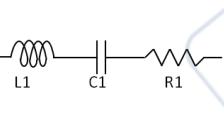
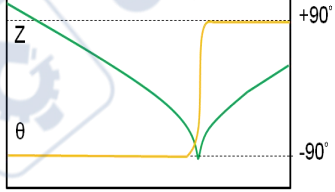
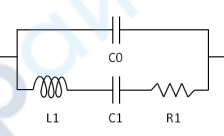
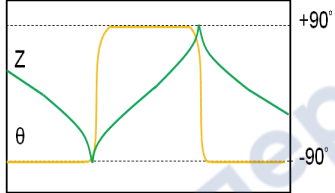
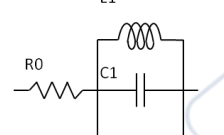
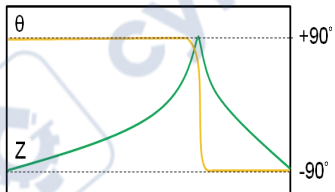
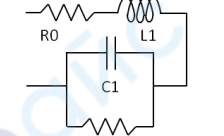
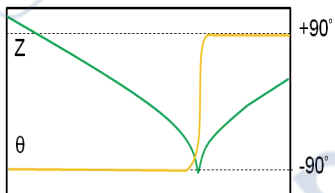
B			<p>Inductor: Inductor with comparatively high ESR</p> <p>Resistor: Resistor with low resistance value and significant wiring inductance effect</p>
C			<p>Capacitor: Capacitor with significant leak resistance effect</p> <p>Resistor: Resistor with high resistance value and significant stray capacitance effect</p>
D			<p>Capacitor: Typical capacitor</p>
E			<p>Piezoelectric element Resonator</p>
F			<p>Inductor with high ESR</p>
G			<p>Capacitor with high ESR</p>

*Typical frequency characteristics graphs

For models A, B, C, D, F and G, the horizontal axis is logarithmic, the vertical axis (Z) is logarithmic, and θ is linear.

For model E, the horizontal axis is linear or logarithmic, the vertical axis (Z) is logarithmic and θ is linear.

7. CORRECTION

Press the <Menu> key and select <CORR.> function key for accessing the CORRECTION page. Before each measuring, the user needs to calibrate (balance) the fixture or the test cable in order to eliminate the stray capacitance and the series impedance that may be produced by the fixture or the test cable. It is especially suitable for the application when using the machine in a new environment or using (replacing) new fixture. For details of fixture connection method, please refer to [3.4.4 Fixture Connecting](#).

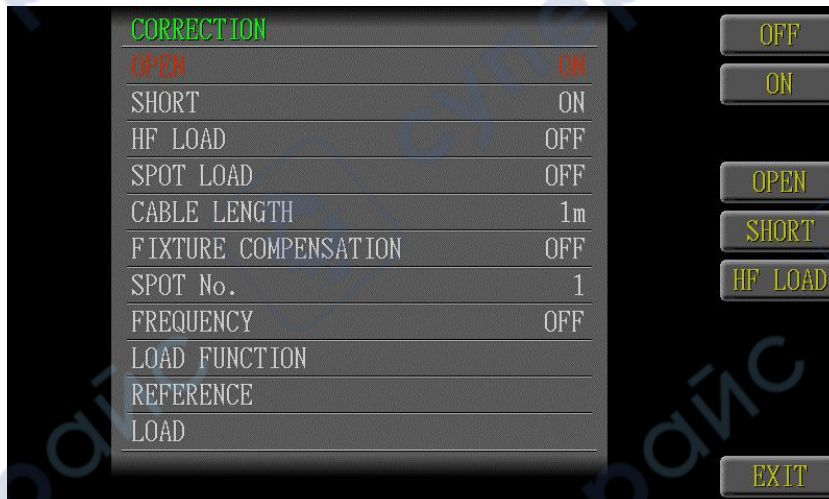

7.1 Open Circuit Correction

In CORRECTION page, use <OFF><ON> function key to open the open circuit correction, and use <Open> function key to do the open circuit correction. Before starting the open circuit correction, do not load the Test Piece to avoid correction failure. If the correction fails or the figure is incorrect, the page will display the correction failure message; if successful, it will return to the CORRECTION page automatically.

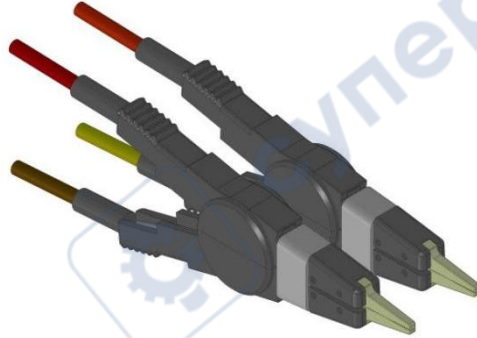

Test Cable Open Circuit Correction Method

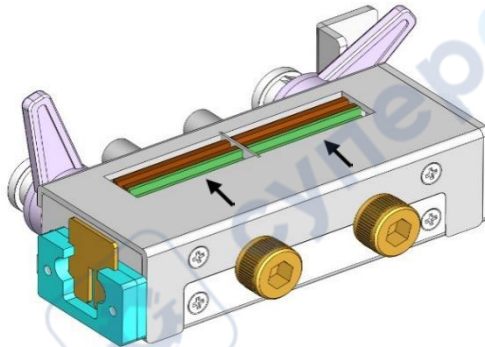

Fixture Open Circuit Correction Method (be sure to lock the reed tightly)

NOTE:

The open circuit correction is quite sensitive to noise - both noise originating externally and induced noise. Therefore, if open circuit correction fails, you should check the following points before starting the correction process again:

- Check that the test fixture or the test cables are properly connected.
- Check that nothing is connected to the test fixture or the test cables. (Open circuit correction cannot be performed while any test piece is connected to the test fixture or the test cables.)
- Check the test leads are arranged as closely as possible to their configuration in which measurement will be performed.
- During the correction process, be sure not to disturb the fixture and the test cables or to move your hand near them.

7.2 Short Circuit Correction

In CORRECTION page, <OFF><ON> function key to open the short circuit correction, and use <Short> function key to do the short circuit correction. Before starting the short circuit correction, please insert the shorting plate into the fixture for executing the short circuit correction. If the correction fails or the figure is incorrect, the page will display the calibration failure message; if successful, it will return to the CORRECTION page automatically.

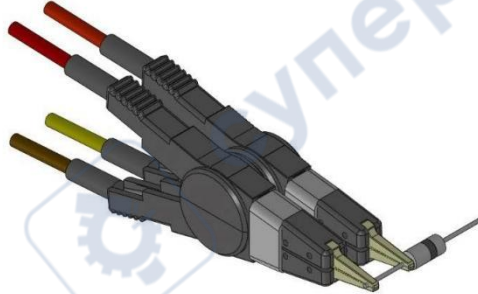

Test Cable Short Circuit Method

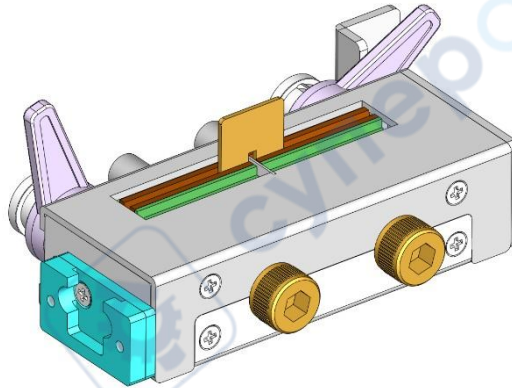

Fixture Short Circuit Method (lock the reed tightly after inserting the shoring bar)

NOTE:

If short circuit correction fails, you should check the following points before starting the correction process again:

- Check that the test fixture or the test cables are properly connected.
- Check that the test fixture or the test cables are properly shorted together with the shoring bar. (Short circuit correction cannot be performed while any test piece is connected to the test fixture or the test cables.)
- Check the test leads are arranged as closely as possible to their configuration in which measurement will be performed.
- During the correction process, be sure not to disturb the fixture and the test cables or to move your hand near them.

7.3 HF LOAD

When the measured frequency exceeded 1MHZ, execution of high frequency load correction is recommended.

Connect the FX-000C19 fixture to the instrument, place the STD-LOAD high frequency correction disk and clamp it tightly in place, and then press high frequency correction.

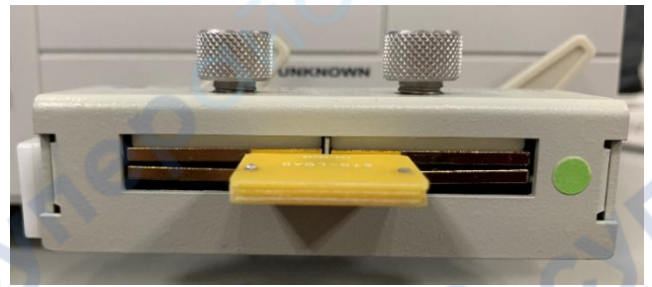
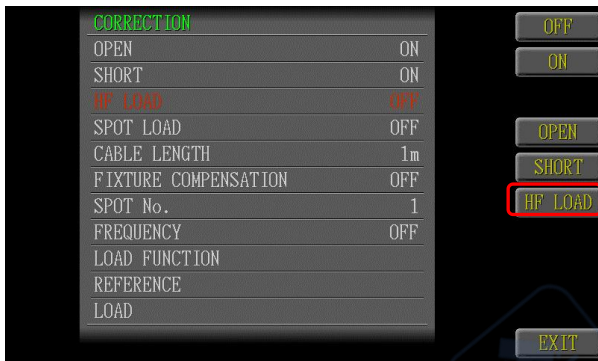

7.4 SPOT LOAD

The fixed frequency point, frequency, load correction parameter and standard reference value can only be set when fixed frequency load correction is set as <ON>.



7.5 CABLE LENGTH

Choose the length of the testing wire. There are 0, 0.5, 1, and 2 meters. Four types of length can be chosen.

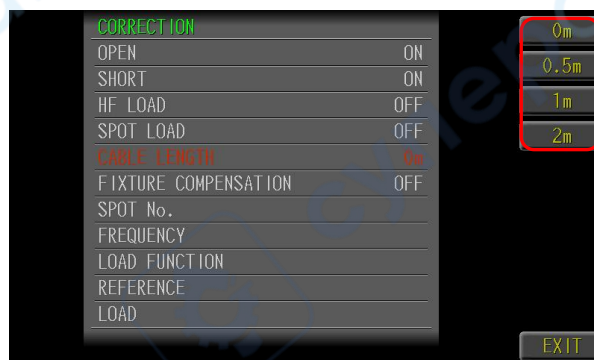

7.6 FIXTURE COMPENSATION

Choose the fixture model. There are <F42001>, <FX-000C20>, <FX-000C19>, <FX-000C12>, <FX-000C10>, <FX-000C8>, <FX-000C7>, and <FX-000C6>.

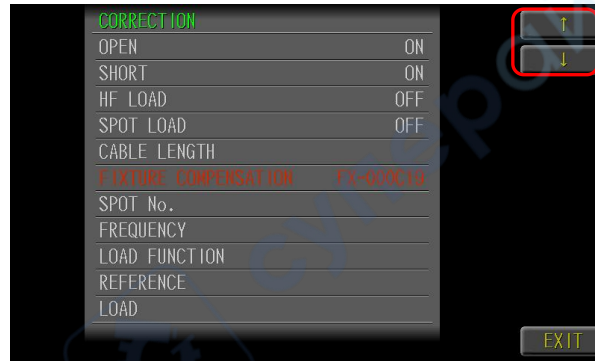

7.7 Spot. No.

Set the fixed frequency point; the range is from 1~16.

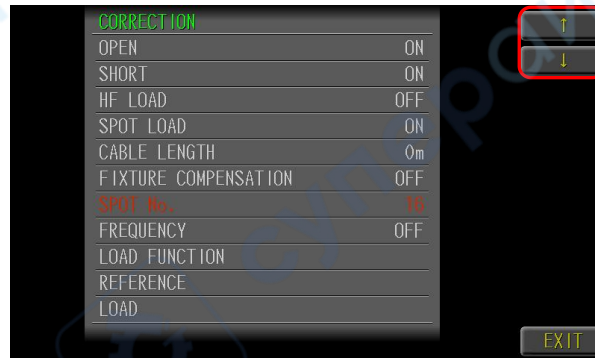

7.8 FREQUENCY

Choose the frequency value

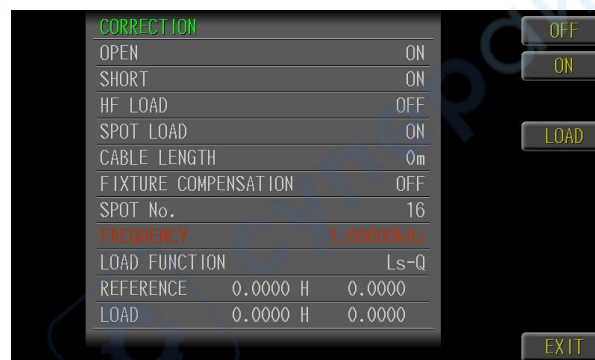

7.9 LOAD FUNCTION

Click the \uparrow / \downarrow swap the primary and secondary parameters.
 (EX:<G-B>, <R-X>, <CP-RP>, <CP-D>, <CS-RS>, <CS-D>, <LP-RP>, <LP-Q>, <LS-RS>, <LS-Q>, <Y-Deg>, <Z-Deg>.)

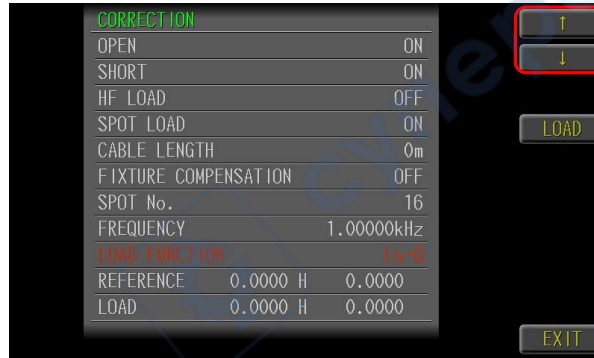

7.10 Reference

Insert the known values with measurements as reference values



7.11 Load

It is the value that is measured in the beginning to correct the result value.



8. SYSTEM CNOFIG

Press <Menu> key and then select <SYSTEM> mode for accessing the SYSTEM CONFIG page. The 9030 Precision Impedance Analyzer supports 3 language interfaces, <English>, <Traditional Chinese> and <Simplified Chinese>. The language can be preset with the function key.

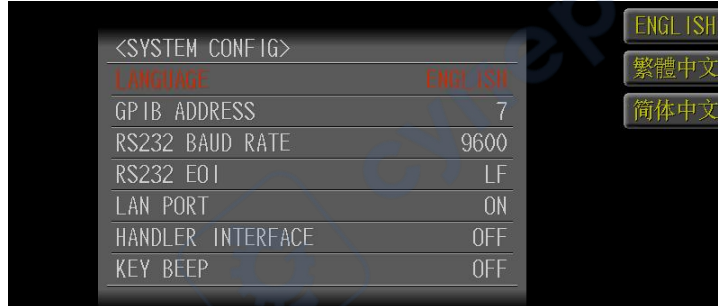

NOTE: The “Specific Term” or “Font” factors must still be expressed in “English”.

8.1 LANGUAGE

Under SYSTEM CONFIG page, select <LANGUAGE> and use <English>, <Traditional Chinese> and <Simplified Chinese> function key to set the language interface.

8.2 GPIB ADDRESS

Under SYSTEM CONFIG page, select <GPIB ADDRESS> and set the GPIB Address within the range of 1~30 with the numeric keypad.

8.3 RS232 BAUD RATE

Under SYSTEM CONFIG page, select <RS232 BAUD RATE> and use <14400>, <19200>, <38400>, <56000> and <115200> function key to set the RS232 Baud Rate.

8.4 RS232 EOI

Under SYSTEM CONFIG page, select <RS232 EOI> and use <LF>, <CR> and <LF+CR> function key to set the RS232 End Of Identify.

8.5 LAN PORT

Selecting <LAN PORT> from the system setting screen also allows selecting of ON or OFF. The LAN setting may be set as manual or automatic, allowing users to control the instrument using LAN functions.

8.6 HANDLERINTERFACE

Under SYSTEM CONFIG page, select <HANDLER INTERFACE>, use <ON><OFF> function key and open the remote I/O control program for the user to monitor the signal input and PASS/FAIL output result by controlling the instrument remotely.

8.7 KEY BEEP

Under SYSTEM CONFIG page, select <KEY BEEP> and use <ON><OFF> function key to set the beep sound when key pressed.

Appendix

|Z| Accuracy Chart

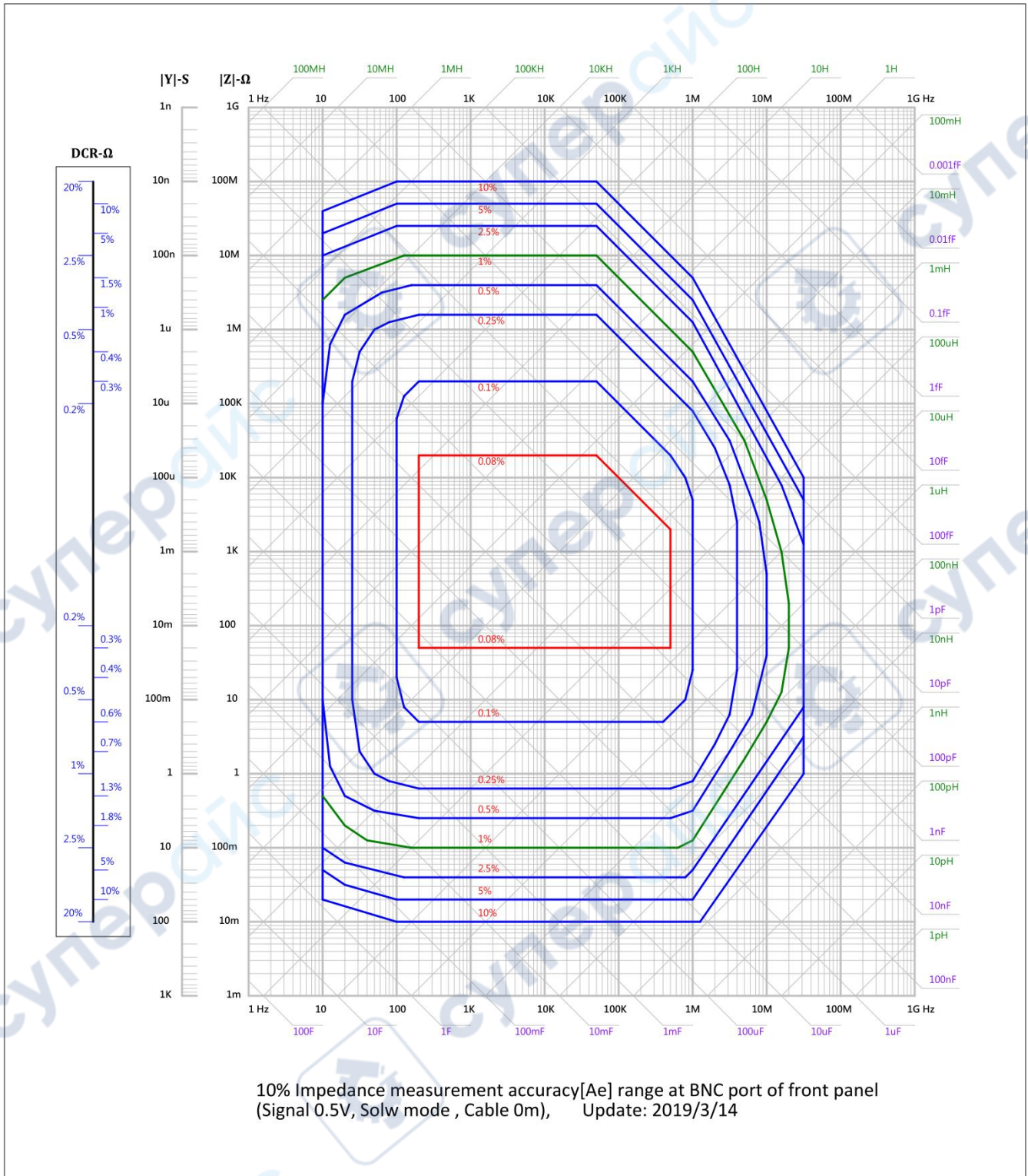

Measurement accuracy

Conditions of accuracy

All specifications apply at 23 ± 5 °C, and 60 minutes after the instrument has been turned on.

Impedance measurement accuracy at 4-terminal test fixture (Typical at > 10 MHz)

	$\pm Ae$ [%],	Where Relative accuracy $Ae = (Ab + Az + Av + Ad) \times Kc \times Kt$	
Z , Y accuracy	[%]		
θ accuracy	$\pm Ae / 100$ [rad]		
L, C, X, B accuracy			
at $Dx \leq 0.1$	$\pm Ae$ [%]		
at $Dx > 0.1$	$\pm Ae \times \sqrt{1+Dx^2}$ [%]		
R accuracy			
at $Dx \geq 10$, ($Qx \leq 0.1$)	$\pm Ae$ [%]		
at $0.1 < Dx < 10$, ($10 > Qx > 0.1$)	$Rs: \pm Ae \times \sqrt{1+Dx^2} / Dx$ [%], $1+Dx^2$ [%]	$Rp: \pm Ae \times \sqrt{1+Dx^2} / (Dx \mp Ae / 100 \times \sqrt{1+Dx^2})$ [%]	
at $Dx \leq 0.1$, ($Qx \geq 10$)	$Rs: \pm Ae / Dx$ [%],	$Rp: \pm Ae / (Dx \mp Ae / 100)$ [%]	
G accuracy			
at $Dx > 0.1$	$\pm Ae \times \sqrt{1+Dx^2} / Dx$ [%]		
at $Dx \leq 0.1$	$\pm Ae / Dx$ [%]		
D accuracy			
at $Dx \leq 0.1$	$\pm Ae / 100$		
at $0.1 < Dx \leq 1$	$\pm Ae \times (1+Dx) / 100$		
Q accuracy (at $Qx \times Da < 1$)			
at $Qx > 10$, ($Dx < 0.1$)	$\pm (Qx^2 \times Ae / 100) / (1 \mp Qx \times Ae / 100)$		
at $Qx \leq 10$, ($Dx \geq 0.1$)	$\pm (Qx^2 \times Ae (1+Dx) / 100) / (1 \mp Qx \times Ae (1+Dx) / 100)$		

NOTE: Da : measurement accuracy of D, Dx : measurement value of D, Qx : measurement value of Q

$$Ae = (Ab + Az + Av + Ad) \times Kc \times Kt \quad [%]$$

Ab [%]	Frequency: F[Hz], Fm[MHz] $F < 200\text{Hz}: 0.08 + (200 / F - 1) \times 0.0222$ $200\text{Hz} \leq F \leq 500\text{kHz}: 0.08$ $F > 500\text{kHz}: 0.08 + (Fm - 0.5) \times 0.0472$
Az [%]	Impedance Range [Ω] $Zx \leq 100\Omega: (100 / Zx - 1) \times 0.001 \times Km$ $F < 100\text{Hz}: Km = 1 + (100/F - 1) \times 0.112$, $100\text{Hz} \leq F \leq 1\text{MHz}: Km = 1$, $F > 1\text{MHz}: Km = 1 + (Fm - 1) \times 3$ $Zx > 100\Omega: (Zx/100 - 1) \times 0.00001 \times Kn \times Kp$ $F < 100\text{Hz}: Kn = 1 + (100/F - 1) \times 0.112$, $100\text{Hz} \leq F \leq 50\text{kHz}: Kn = 1$, $F > 50\text{kHz}: Kn = F/50K$ $F \leq 1\text{MHz}: Kp = 1$, $F > 1\text{MHz}: Kp = 1 + (Fm - 1) \times 0.5$
Av [%]	Signal Level [V] $Vac > 0.5V: (Vac - 0.5)^2 \times 0.45 \times (1 + Fm/30)$ $Vac \leq 0.5V: (0.5/Vac - 1) \times 0.25$
Ad [%]	Measurement Speed (5) SLOW2: 0 (4) SLOW : 0 (3) MED : 0.1 (2) FAST : 0.2 (1) MAX : 0.4
Kc	Cable length [m] 0 m: 0 0.5 m: $0.02 + 0.01 \times Fm$ 1 m: $0.02 + 0.02 \times Fm$ 2 m: $0.02 + 0.03 \times Fm$ Fm: 0 to 30 [MHz] Fm: 0 to 20 [MHz] Fm: 0 to 10 [MHz] Fm: 0 to 5 [MHz]
Kt	Temperature [°C] 8 - 18°C: 4 18 - 28°C: $1 + (T - 23)^2 \times 0.0139$ 28 - 38°C: 4

Measurement Time / Averaging

Measurement Speed	1.Max:	2.5ms (>10kHz)
	2.Fast:	50ms (>20Hz)
	3.Medium:	100ms
	4.Slow:	300ms
	5.Slow2:	600ms
Display Time	1.6 ~ 5.6ms (depend on the contents)	
Averaging Range	1 to 64	

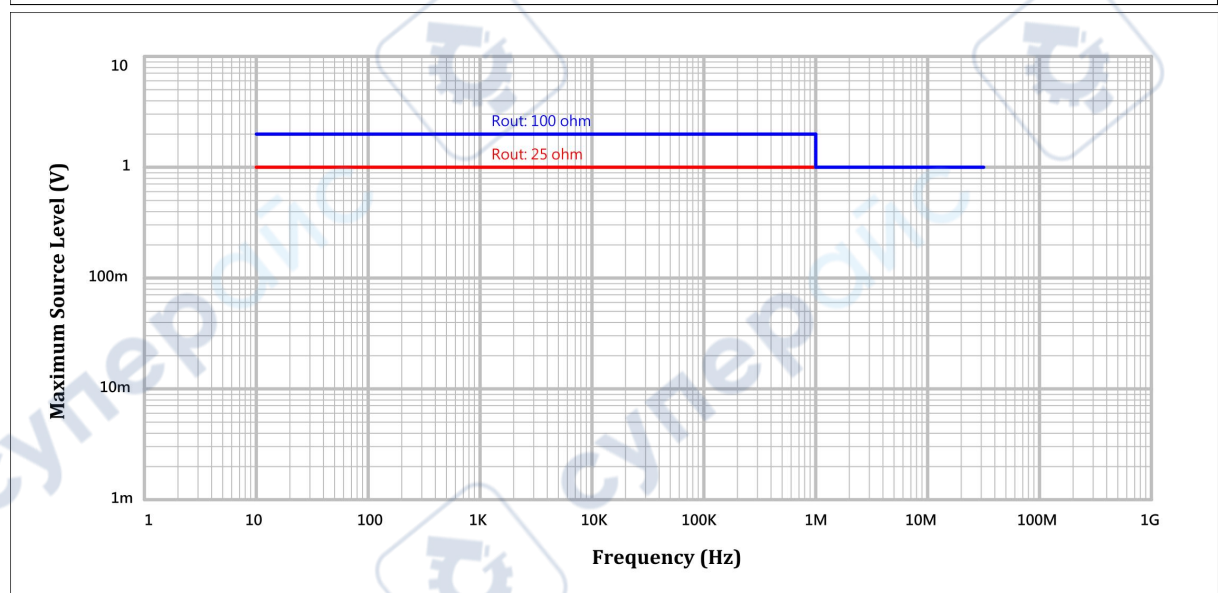
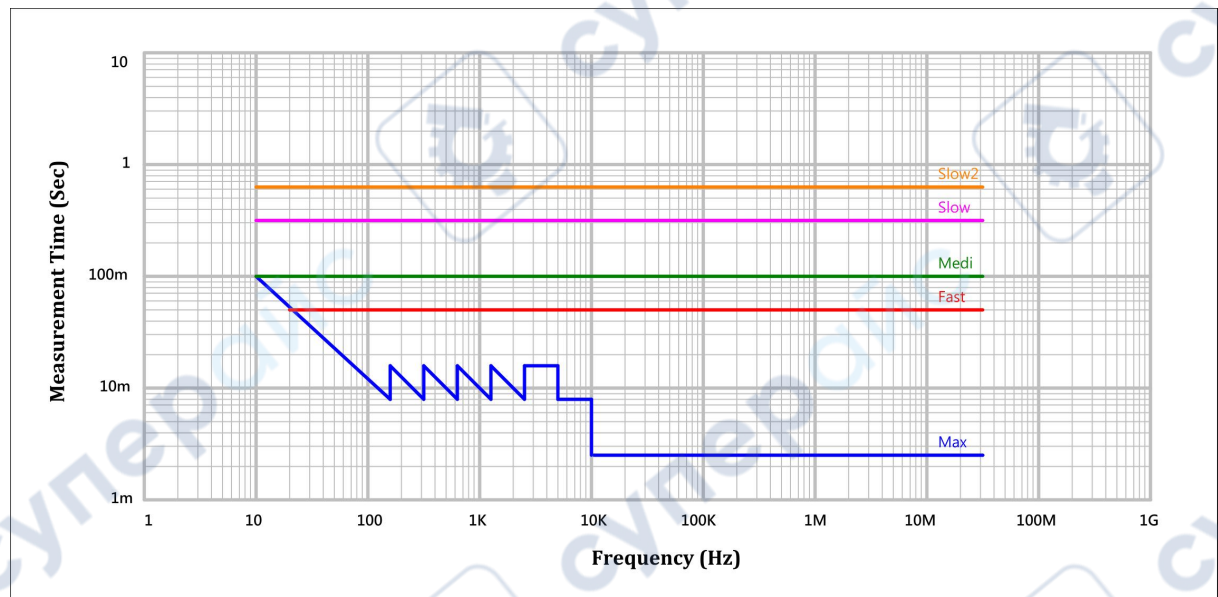

Concept of Command

◆ Subsystem Command Tree

The top of the subsystem command tree is called the root command, or simply the root. To reach the low-level commands, you must specify a particular path. After Power ON or after *RST, the current path is set to the root. The path settings are change as follows:

Colon (:)
When a colon is placed between two command mnemonics, the colon moves the current path down on level on the command tree. When the colon is the first character of a command, it specifies that the following command mnemonics a root-level command.

Semicolon (;)
A semicolon separates two commands in the same message without changing the current path.

Proper use of the Colon and Semicolon as follows:

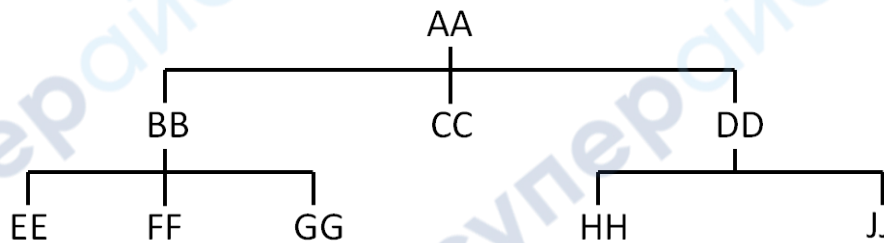

1. $\begin{matrix} \boxed{R} & \boxed{D} \\ :AA:CC \end{matrix}$

2. $\begin{matrix} \boxed{R} & \boxed{D} & \boxed{D} & \boxed{N} & \boxed{N} \\ :AA:BB:EE;FF;GG \end{matrix}$

3. $\begin{matrix} \boxed{R} & \boxed{D} & \boxed{D} & \boxed{N} \\ :AA:DD:HH;JJ \end{matrix}$

4. $\begin{matrix} \boxed{R} & \boxed{D} & \boxed{D} & \boxed{N} & \boxed{R} & \boxed{D} & \boxed{D} \\ :AA:BB:EE;:AA:DD:HH \end{matrix}$

R) Sets current path to ROOT

N) No change to current path

D) Set current path DOWN one level

It shows how character input time can be saved by properly using semicolons. Sending the message

`:AA:BB:EE;FF;GG`

is equivalent to sending the following three messages.

`:AA:BB:EE`
`:AA:BB:FF`
`:AA:BB:GG`

◆ Data Format

①②③④

`:MEASure:PARAMeter<NR1> LF`

1. Command
2. Space
3. Parameter
4. Program Message Terminator

Parameter:

There must be a <space> between the last command and the first parameter in a subsystem command.

For example: `:MEASure:PARAMeter Z`

If you send more than one parameter with a single command, each parameter must be separated by a comma.

For example: `:MEASure:PARAMeter Z,LS,Q`

<> Angular brackets enclose words or characters that are used to symbolize a program code parameter or a command.

<NR1> Integers	Example: 1,2,3,4
<NR2> Decimal number	Example: 0.1,0.23,0.001
<NR3> Float	Example: 2.2E+2,1.1E-1
<disc> Discrete data	Example: ON,OFF,MAXimum,MINimum

{ } When several items are enclosed by braces, one and only one of these elements may be selected. A vertical bar can be read as "or" and is used to separate alternative parameter options.

For example: `:MEASure:SPEEd{MAXimum|FAST|MEDIUM|SLOW|SLOW2}`
Means `:MEASure:SPEEd MAXimum` or `:MEASure:SPEEd FAST.....`

◆ Common Commands

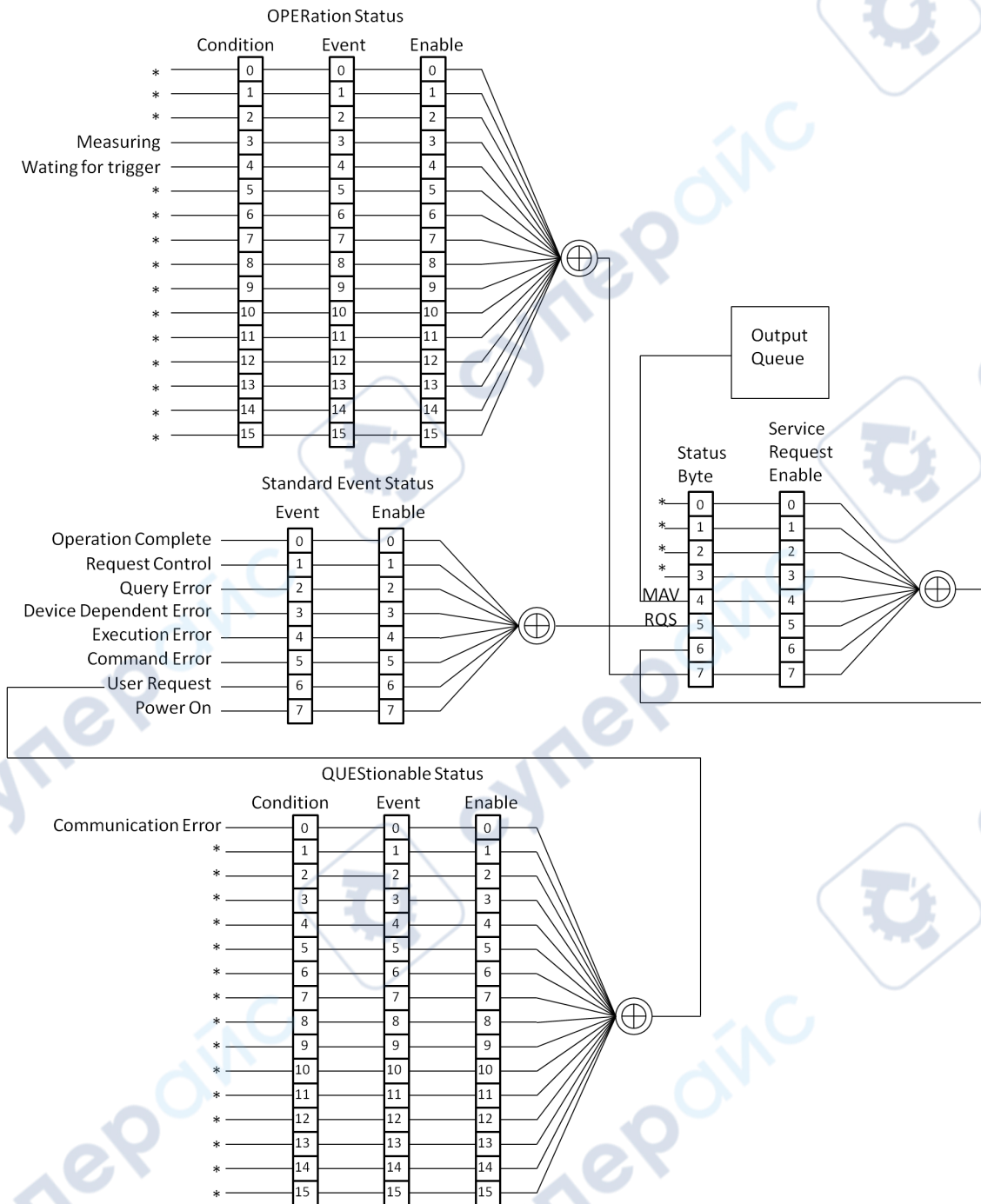

<Command> :STATus:OPERation:CONDition?

Function: It queries the status of Operation Status Register.

Description:

Return data 0~65535 (Format is in <NR1>)

<Command> :STATus:OPERation:EVENT?

Function: It queries the status of Operation Event Register.

Description:

Return data 0~65535 (Format is in <NR1>)

<Command> :STATus:OPERation:ENABle <NR1>
:STATus:OPERation:ENABle?

Function: It sets or queries the status of Operation Enable Register.

Description:

Set parameter 0~65535 <NR1>
Set syntax:STATus:OPERation:ENABle 65535
Query syntax:STATus:OPERation:ENABle?
Return data 65535 (Format is in <NR3>)

<Command> :STATus:QUESTionable:CONDition?

Function: It queries the status of Questionable Condition Register.

Description:

Return data 0~65535 (Format is in <NR1>)

<Command> :STATus:QUESTionable:EVENT?

Function: It queries the status of Questionable Event Register.

Description:

Return data 0~65535 (Format is in <NR1>)

<Command> :STATus:QUESTionable:ENABle <NR1>
:STATus:QUESTionable:ENABle?

Function: It sets or queries the status Questionable Enable Register.

Description:

Set parameter 0~65535 <NR1>
Set syntax:STATus:QUESTionable:ENABle 65535
Query syntax:STATus:QUESTionable:ENABle?
Return data 0~65535 (Format is in <NR1>)

<Command> *CLS

Function: It clears Error Queue, Standard Event Status Register, Status Byte Register, and Operation Event Register.

<Command> *ESE <NR1>
*ESE?

Function: It sets or queries the status of Standard Event Status Enable Register.

Description:

Set parameter 0~255
Set syntax *ESE 1
Query syntax *ESE?
Return data 0~255 (Format is in <NR1>)

<Command> *ESR?

Function: It queries the status of Standard Event Status Register, clean the Register after executed.

Description:

Return data <NR1>

<Command> *IDN?

Function: It queries the device basic data.

Description:

Return data MATRIX,9030-30G,0,1.194<field1>,<field2>,<field3>,<field4>
<field1>manufacturer
<field2>model number
<field3>serial number or 0
<field4>firmware revision
MATRIX,9030-30G,0,1.194

<Command> *OPC

Function: It sets Standard Event Status Register to 0 bit,when all operations are completed.

<Command> *OPC?

Function: When all operations are completed, 1 will be returned.

<Command> *OPT?

Function: It queries the installed in the system interface.

Description:

If 9030 MAX test frequency is 1MHz , it returns F01
If 9030 MAX test frequency is 3MHz, it returns F03
If 9030 MAX test frequency is 5MHz, it returns F05
If 9030 MAX test frequency is 10MHz, it returns F10
If 9030 MAX test frequency is 15MHz, it returns F15
If 9030 MAX test frequency is 20MHz, it returns F20
If 9030 MAX test frequency is 30MHz, it returns F30

<Command> *RST

Function: It aborts all pending operations, and sets 9030 to its initial setups.

Description:

Initial Setups
Parameters:Ls,Q,Z, θ deg
FREquency:1kHz
LEVEL:1Vac
SPEED:MED.
TRIGger:REPEAT

<Command> *SRE <NR1>

***SRE?**

Function: It sets or queries the status of Service Request Enable Register.

Description:

Set parameter 0~255
Set syntax *SRE 1
Query syntax *SRE?
Return data 0~255 (Format is in <NR1>)

<Command> *STB?

Function: It queries the status of Service Request Status Register

Description:

Return data <NR1>

<Command> *WAI

Function: It makes 9030 wait until all previously sent commands are completed. The 9030 then continues executing the commands that follow the *WAI.

<Command> *TST

Function: The response to this query is always 0.

<Command> *TRG

*TRG?
:TRIGger
:TRIGger?

Function: It executes Trigger action. If using *TRG? and :TRIGger, it executes Trigger action and returns test data.

<Command> :DISPlay:PAGE

{MEASure|SWEep|CORRection|LSET|LRUN|LCORRection|SYSTem}
:DISPlay:PAGE?

Function: It sets or queries the page currently displayed on the LCD screen.

Description:

Set parameter MEASure(meter mode), SWEep(sweep mode), CORRection(correction page),s

LSET(list mode), LRUN(list run), LCORRection(list correction page), SYSTem(system page).

Set syntax :DISPlay:PAGE MEASure

:DISPlay:PAGE SWEep

Query syntax :DISPlay:PAGE?

Return data MEAS (Format is in <disc>)

◆ MEASure Subsystem

```
<Command> :MEASure:PARAMeter  
{OFF|RDC|LS|LP|CS|CP|Q|D|RS|RP|Z|DEG|RAD|R|X|Y|G|B|E|U}  
:MEASure:PARAMeter?
```

Function: It sets or queries the measurement parameter (max.4 items) at present.

Description:

Set parameter OFF, RDC(DC Resistance), Ls(Series Inductance), Lp(Parallel Inductance), Cs (Series Capacitance), Cp (Parallel Capacitance), Q (Quality Factor), D (Dissipation Factor), Rs (Series Resistance) Rp(Parallel Resistance), Z(Impedance), θ_d (Angle), θ_r (Diameter), R(Resistance), X(Reactance), Y (Admittance), G (Conductivity), B (Susceptance), E(Relative Permittivity), U(Relative permeability)

Set syntax:MEASure:PARAMeter RDC,Z,DEG,OFF

RDC is the first measure parameter, the second is Z, the third is θ_{deg} , and the forth is OFF.

Query syntax:MEASure:PARAMeter?

Return dataRDC,Z,DEG,OFF

```
<Command> :MEASure:FREQUENCY<frequencyNR3/disc>  
:MEASure:FREQUENCY?
```

Function: It sets or queries the FREQUENCY.

Description:

Set parameterThe setup value of frequency is {10.0~30000000.0|MAXimum|MINimum}.

Set syntax:MEASure:FREQUENCY 1000

:MEASure:FREQUENCY1K

:MEASure:FREQUENCY 1KHZ

:MEASure:FREQUENCY 1E3

:MEASure:FREQUENCY MAXimum

:MEASure:FREQUENCY MINimum

Query syntax:MEASure:FREQUENCY?

Return data 1.000000E+03 (Format is in <NR3>)

```
<Command> :MEASure:SPEED  
{MAXimum|FAST|MEDIUM|SLOW|SLOW2|0|1|2|3|4}  
:MEASure:SPEED?
```

Function: It sets or queries the SPEED.

Description:

Set parameter MAXimum/0, FAST/1, MEDIUM/2, SLOW/3, SLOW2/4

Set syntax:MEASure:SPEED 1

:MEASure:SPEED FAST

Query syntax:MEASure:SPEED?

Return data FAST (Format is in <disc>)

```
<Command> :MEASure:BEEPer {OFF|PASS|OK|FAIL|NG|0|1|2}  
:MEASure:BEEPer?
```

Function: It sets or queries the BEEP WHEN.

Description:

Set parameterOFF, PASS|OK, FAIL|NG

Set syntax:MEASure:BEEPer PASS

:MEASure:BEEPer NG

:MEASure:BEEPer OFF

Query syntax:MEASure:BEEPer?

Return dataPASS| FAIL| OFF

<Command> :MEASure:VOLTage:AC <voltage NR3/disc>
:MEASure:VOLTage:AC?

Function: It sets or queries the AC measurement voltage (LEVEL).

Description:

Set parameter When RO(output impedance) is setting 100Ω, the setup value of AC voltage is {0.01~2|MAXimum|MINimum}. When RO(output impedance) is setting 25Ω, the setup value of AC voltage is {0.01~1|MAXimum|MINimum}.

Set syntax:MEASure:VOLTage:AC 1

:MEASure:VOLTage:AC 1M

:MEASure:VOLTage:AC 1MV

:MEASure:VOLTage:AC 1E-3

:MEASure:VOLTage:AC MAXimum

:MEASure:VOLTage:AC MINimum

Query syntax:MEASure:VOLTage:AC?

Return data 1.000000E+00 (Format is in <NR3>)

When the Level setup is current mode, the data returns 9.9E37.

<Command> :MEASure:VOLTage:DC <voltage NR3/disc>
:MEASure:VOLTage:DC?

Function: It sets or queries the DC measurement voltage (LEVEL).

Description:

Set parameter The value of DC voltage is {0.01~1|MAXimum|MINimum}.

Set syntax:MEASure:VOLTage:DC 1

:MEASure:VOLTage:DC 1M

:MEASure:VOLTage:DC 1MV

:MEASure:VOLTage:DC 1E-3

:MEASure:VOLTage:DC MAXimum

:MEASure:VOLTage:DC MINimum

Query syntax:MEASure:VOLTage:DC?

Return data 1.000000E+00 (Format is in <NR3>)

When the Level setup is current mode, the data returns 9.9E37.

<Command> :MEASure:CURRent:AC <current NR3/disc>
:MEASure:CURRent:AC?

Function: It sets or queries the AC measurement current (LEVEL).

Description:

Set parameter When RO(output impedance) is setting 100Ω, the setup value of AC current is {0.0002~0.02|MAXimum|MINimum}. When RO(output impedance) is setting 25Ω, the setup value of AC current is {0.0002~0.04|MAXimum|MINimum}.

Set syntax:MEASure:CURRent:AC 0.01

:MEASure:CURRent:AC 10M

:MEASure:CURRent:AC 10MA

:MEASure:CURRent:AC 1E-2

:MEASure:CURRent:AC MAXimum

:MEASure:CURRent:AC MINimum

Query syntax:MEASure:CURRent:AC?

Return data 1.000000E-02 (Format is in <NR3>)

When the Level setup is voltage mode, the data returns 9.9E37.

<Command> :MEASure:CURRent:DC <current NR3/disc>
:MEASure:CURRent:DC?

Function: It sets or queries the DC measurement current (LEVEL).

Description:

Set parameter The value of DC current is {0.0002~0.04|MAXimum|MINimum}.

Set syntax:MEASure:CURRent:DC 0.01

:MEASure:CURRent:DC 10M

:MEASure:CURRent:DC 10MA

:MEASure:CURRent:DC 1E-2

:MEASure:CURRent:DC MAXimum

:MEASure:CURRent:DC MINimum

Query syntax:MEASure:CURRent:DC?

Return data 1.000000E-02 (Format is in <NR3>)

When the Level setup is voltage mode, the data returns 9.9E37.

<Command> :MEASure:ALC {OFF|ON|0|1}
:MEASure:ALC?

Function: It sets or queries the ALC.

Description:

Query syntax:MEASure:ALC?

Return data When the setup is OFF, it returns 0.

When the setup is ON, it returns 1.

<Command> :MEASure:SMONitor {0|1|OFF |ON }
:MEASure:SMONitor?

Function: It sets or queries the DISPLAY Vm/Im

Description:

Query syntax:MEASure: SMONitor?

Return data When the setup is OFF, it returns 0.

When the setup is ON, it returns 1.

<Command> :FETCH:SMONitor:DC?

Function: It queries the DC voltage and current.

Description:

Query syntax:FETCH:SMONitor:DC?

Return data 1.000000E-03,3.791975E-02 Vm,Im(Format is in <NR3>)

<Command> :FETCH:SMONitor:AC?

Function: It queries the AC voltage and current.

Description:

Query syntax:FETCH:SMONitor:AC?

Return data 1.000000E-03,3.791975E-02 Vm,Im (Format is in <NR3>)

<Command> :MEASure:AVERage <averageNR1>
:MEASure:AVERage?

Function: It sets or queries the AVERAGE.

Description:

Set parameter The value of the Average is {0~64}

Set syntax:MEASure:AVERageage 10

Query syntax: MEASure:AVERageage?

Return data 10 (Format is in <NR1>)

<Command> :MEASure:FONT {SMALl|LARGe}
:MEASure:FONT?

Function: It sets or queries the FONT SIZE.

Description:

Set parameter SMALl (small), LARGe (large)

Set syntax: MEASure:FONT LARGe

Query syntax: MEASure:FONT?

Return data LARG (Format is in <disc>)

<Command> :MEASure:TRIGger:DELay <delay time NR3/disc>
:MEASure:TRIGger:DELay?

Function: It sets or queries the TRIGGER DELAY.

Description:

Set parameter The value of delay time is {0.0~5|MAXimum|MINimum}.

Set syntax: MEASure:TRIGger:DELay 0.5

:MEASure:TRIGger:DELay 500M

:MEASure:TRIGger:DELay 500MS

:MEASure:TRIGger:DELay 5E-3

:MEASure:TRIGger:DELay MAXimum

:MEASure:TRIGger:DELay MINimum

Query syntax: MEASure:TRIGger:DELay?

Return data 0.500 (Format is in <NR2>)

<Command> :MEASure:DELay <delay time NR3/disc>
:MEASure:DELay?

Function: It sets or queries the AC/DC DELAY.

Description:

Set parameter The value of delay time is {0.0~5|MAXimum|MINimum}.

Set syntax: MEASure:DELay 0.5

:MEASure:DELay 500M

:MEASure:DELay 500MS

:MEASure:DELay 5E-3

:MEASure:DELay MAXimum

:MEASure:DELay MINimum

Query syntax: MEASure:DELay?

Return data 0.500 (Format is in <NR2>)

<Command> :MEASure:TRIGger:MODE {REPeat|0|SINGle|1}

Function: It sets or queries the TRIGGER MODE.

Description:

Set parameter REPeat, 0 (repeat) · SINGle, 1 (single)

Set syntax: MEASure:TRIGger:MODE SINGle

Query syntax: MEASure:TRIGger:MODE?

Return data REP | SING (Format is in <disc>)

<Command> :MEASure:RANGe:DC {1|2|3|4|AUTO|HOLD}
:MEASure:RANGe:DC?

Function: It sets or queries the DC RANGE.

Description:

Set parameter{1|2|3|4|AUTO|HOLD}

Set syntax:MEASure:RANGe:DC 2

:MEASure:RANGe:DC AUTO

Query syntax:MEASure:RANGe:DC

Return Data 2 (Format is in <NR1>)

<Command> :MEASure:RANGe:AC {1|2|3|4|AUTO|HOLD}

Function: It sets or queries the AC RANGE.

Description:

Set parameter{1|2|3|4|AUTO|HOLD}

Set syntax:MEASure:RANGe:AC 3

:MEASure:RANGe:AC AUTO

Query syntax:MEASure:RANGe:AC

Return data 3 (Format is in <NR1>)

<Command> :MEASure:OIMPedance {100|25}
:MEASure:OIMPedance?

Function: It sets or queries the RO.

Description:

Query syntax:MEASure:OIMPedance?

Return data 100|25 (Format is in <NR1>)

<Command> :MEASure:COMParator:PARAMeter {1|2|3|4}
:MEASure:COMParator:PARAMeter?

Function: It sets or queries which parameters number is to be compared.

Description:

Set syntax:MEASure:COMParator:PARAMeter 3 (After this command, every compared setup is at this parameters number.)

Query syntax:MEASure:COMParator:PARAMeter?

Return data3 (Format is in <NR1>)

<Command> :MEASure:COMParator:STATe {OFF|ON|0|1}
:MEASure:COMParator:STATe?

Function: It sets or queries the COMP open or not.

Description: :MEASure:COMParator:STATe?

Return dataWhen the setup is OFF, it returns 0.

When the setup is ON, it returns 1.

<Command> :MEASure:COMParator:MODE <ABSolute|DEViation|PERCent|0|1|2>

Function: It sets or queries the COMP MODE.

Description:

Set parameterABSolute,0|DEViation,1|PERCent,2

Set syntax:MEASure:COMParator:MODE PERCent

Query syntax:MEASure:COMParator:MODE?

Return dataPERC (Format is in <disc>)

<Command> :MEASure:COMParator:NOMinal <nominal value NR3>
:MEASure:COMParator:NOMinal?

Function: It sets or queries the NOMINAL.

Description:

Set syntax:MEASure:COMParator:NOMinal 1000
:MEASure:COMParator:NOMinal 1K
:MEASure:COMParator:NOMinal 1E+03
Query syntax:MEASure:COMParator:NOMinal?
Return data 1.000000E+03 (Format is in <NR3>)

<Command> :MEASure:COMParator:UPPER <upper limit NR3>
:MEASure:COMParator:UPPER?

Function: It sets or queries the UPPER.

Description:

Set syntax:MEASure:COMParator:UPPER 1
:MEASure:COMParator:UPPER1000M
:MEASure:COMParator:UPPER 1E+00
Query syntax:MEASure:COMParator:UPPER?
Return data 1.000000E+00 (Format is in <NR3>)

<Command> :MEASure:COMParator:LOWER <LOWER limit NR3>

Function: It sets or queries the LOWER.

Description:

Set syntax:MEASure:COMParator:LOWER -1
:MEASure:COMParator:LOWER -1000M
:MEASure:COMParator:LOWER -1E+00
Query syntax:MEASure:COMParator:LOWER?
Return data -1.000000E+00 (Format is in <NR3>)

<Command> :MEASure:COMParator:DISPlay <ABSolute|DEViAtion|PERCent|0|1|2>
:MEASure:COMParator:DISPlay?

Function: It sets or queries the DISP MODE.

Description:

Set parameterABSolute,0|DEViAtion,1|PERCent,2
Set syntax:MEASure:COMParator:MODE DEViAtion
Query syntax:MEASure:COMParator:MODE?
Return dataDEV(Format is in <disc>)

<Command> :MEASure:BIN:PARAMeter
{OFF|RDC|LS|LP|CS|CP|Q|D|RS|RP|Z|DEG|RAD|R|X|Y|G|B|E|U}
:MEASure:BIN:PARAMeter?

Function: It sets or queries the BIN Parameter.

Description:

Set syntax:MEASure:BIN:PARAMeter Z(only allow the parameter which is being used under the meter mode.)
Query syntax:MEASure:PARAMeter?
Return dataZ(Format is in <disc>)

<Command> :MEASure:BIN:NUMBER {2|3|4|5|6|7|8|9|MAXium|MINimum}
:MEASure:BIN:NUMBER?

Function: It sets or queries the BIN NUMBER.

Description:

Set parameter The value of bin number is {2~9|MAXimum|MINimum}.

Set syntax: MEASure:NUMBER 4

Query syntax: MEASure:NUMBER?

Return data 4 (Format is in <NR1>)

<Command> :MEASure:BIN:METHOD {EQUal|SEQuential|TOLerance|RANDom|0|1|2|3}
:MEASure:BIN:METHOD?

Function: It sets or queries the BIN METHOD.

Description:

Set parameter EQUal,0| SEQuential,1|TOLerance,2 |RANDom,3

Set syntax: MEASure:METHOD SEQ

Query syntax: MEASure:METHOD?

Return data SEQ (Format is in <disc>)

<Command> :MEASure:BIN:MODE <ABSolute|DEViation|PERCent|0|1|2>
:MEASure:BIN:MODE?

Function: It sets or queries the BIN MODE.

Description:

Set parameter ABSolute,0|DEViation,1|PERCent,2

Set syntax: MEASure:BIN:MODE DEViation

Query syntax: MEASure:BIN:MODE:MODE?

Return data DEV (Format is in <disc>)

<Command> :MEASure:BIN:NOMinal <nominal value NR3 >
:MEASure:BIN:NOMinal?

Function: It sets or queries the BIN NOMINAL.

Description:

Set syntax: MEASure:BIN:NOMinal 1000

:MEASure:BIN:NOMinal 1K

:MEASure:BIN:NOMinal 1E+03

Query syntax: MEASure:BIN:NOMinal?

Return data 1.000000E+03 (Format is in <NR3>)

<Command> :MEASure:BIN:LIMit <nominal value NR3 >
:MEASure:BIN:LIMit?

Function: It sets or queries the BIN LIMIT.

Description:

Set syntax: MEASure:BIN:LIMit 0.001,100M,1k,1000k

Query syntax: MEASure:BIN:LIMit?

Return data +1.000000E-03, +1.000000E-01, +1.000000E+03, +1.000000E+06 (Format is in <NR3>)

<Command> :MEASure:FILE:LOAD <filename>

Function: It opens the meter mode's file.

Description:

Set syntax: MEASure:FILE:LOAD MATRIX. (open the MATRIX meter mode's file)

<Command> :MEASure:FILE:LOAD?

Function: It queries the meter mode's filename which is being using.

Description:

Query syntax:MEASure:FILE:LOAD?

Return dataMATRIX

<Command> :MEASure:BIAS:VOLTage<NR3>

Function: It sets the BIAS Voltage.

Description:

Query syntax: MEASure:BIAS:VOLTage -12

<Command> : MEASure:BIAS:VOLTage?

Function: It queries the BIAS Voltage.

Description:

Query syntax: MEASure:BIAS:VOLTage?

Return data -1.200000E+01

<Command> : MEASure:BIAS:STATe<ON|OFF|0|1>

Function: It sets the BIAS Voltage enabled/disabled.

Description:

Query syntax: MEASure:BIAS:STATe 1

Return data -1.200000E+01

<Command> : MEASure:BIAS:STATe?

Function: It queries the BIAS Voltage enabled/disabled.

Description:

Query syntax: MEASure:BIAS:STATe?

Return data When the setup is OFF, it returns 0.

When the setup is ON, it returns 1.

<Command> :FETCh?

Function: It fetches the measurement data currently test mode.

<Command> :CORRection:OPEN

:CORRection:OPEN?

Function: It sets or queries to do open correction.

Description:

Query syntax:CORRection:OPEN?

Return data When correction fail, it returns 0.

When correction passes, it returns 1.

<Command> :CORRection:SHORT

:CORRection:SHORT?

Function: It sets or queries to do short correction.

Description:

Query syntax:CORRection:SHORT?

Return data When correction fail, it returns 0.

When correction passes, it returns 1.

<Command> :CORRection:OPEN:STATe {OFF|ON|0|1}

:CORRection:OPEN:STATe?

Function: It sets or queries the status of open correction.

Description:

Query syntax:CORRection:OPEN:STATe?

Return dataWhen the setup is OFF, it returns 0.

When the setup is ON, it returns 1.

```
<Command> :CORRection:SHORT:STATe {OFF|ON|0|1}
:CORRection:SHORT:STATe?
```

Function: It sets or queries the status of short correction.

Description:

Query syntax:CORRection:SHORT:STATe?

Return dataWhen the setup is OFF, it returns 0.

When the setup is ON, it returns 1.

```
<Command> :CORRection:CABLe {0|0.5|1|2}
:CORRection:CABLe?
```

Function: It sets or queries the status of cable length correction.

Description:

Query syntax:CORRection:CABLe?

Return data0|0.5|1|2

There are two options for trigger and query:

1. Give command ***TRG**or **:TRIG?** and get measuring result (recommend)
2. Give command **:TRIG**for trigger and give **:FETCH?** to get measuring result

To be sure currently step is under MEAS mode, or give command **:DISP:PAGE MEAS** to enter MEAS mode.

◆ LIST Subsystem

<Command> :LIST:STEP{1|2|3|4|...|14|15}
:LIST:STEP?

Function: It sets or queries the step of list mode.

Description:

Set parameter step number 1~15

Set syntax: LIST:STEP 1

Query syntax: LIST:STEP?

Return data 1 (Format is in <NR1>)

<Command> :LIST:PARAMeter
{OFF|RDC|LS|LP|CS|CP|Q|D|RS|RP|Z|DEG|RAD|R|X|Y|G|B}
:LIST:PARAMeter?

Function: It sets or queries the measurement parameter of list mode.

Description:

Set parameter There is no E (Relative Permittivity) and U (Relative permeability) in the list mode.

Set syntax: LIST:PARAMeter Z

Query syntax: LIST:PARAMeter?

Return data Z (Format is in <disc>)

<Command> :LIST:FREQUency <frequency NR3/disc>
:LIST:FREQUency?

Function: It sets or queries the measurement frequency of list mode.

Description:

Set parameter frequency 10.0~30000000.0 · MAXimum/MINimum °

Set syntax: LIST:FREQUency 1000

:LIST:FREQUency 1K

:LIST:FREQUency 1KHZ

:LIST:FREQUency 1E3

:LIST:FREQUency MAXimum

:LIST:FREQUency MINimum

Query syntax: LIST:FREQUency?

Return data 1.000000E+03 (Format is in <NR3>)

<Command> :LIST:VOLTage <voltage NR3/disc >
:LIST:VOLTage?

Function: It sets or queries the measurement voltage of list mode.

Description:

Set parameter When RO (output impedance) is setting 100Ω, the setup range of AC voltage is {0.01~2|MAXimum|MINimum}. When RO (output impedance) is setting 25Ω, the setup range of AC voltage is {0.01~1|MAXimum|MINimum}. The range of DC voltage is {0.01~1|MAXimum|MINimum}.

Set syntax: LIST:VOLTage 1

:LIST:VOLTage 1M

:LIST:VOLTage 1MV

:LIST:VOLTage 1E-3

:LIST:VOLTage MAXimum

:LIST:VOLTage MINimum

Query syntax: LIST:VOLTage?

Return data 1.000000E+00 (Format is in <NR3>)

When the Level setup is current mode, the data returns 9.9E37.

<Command> :LIST:CURRent <current NR3/disc >
:LIST:CURRent?

Function: It sets or queries the measurement current of list mode.

Description:

Set parameterWhen RO(output impedance) is setting 100Ω, the setup range of AC current is {0.0002~0.02|MAXimum|MINimum}. When RO(output impedance) is setting 25Ω, the setup range of AC current is {0.0002~0.04|MAXimum|MINimum}. The range of DC current is {0.0002~0.04|MAXimum|MINimum}.

Set syntax:LIST:CURRent 1

:LIST:CURRent 1M

:LIST:CURRent 1MA

:LIST:CURRent 1E-3

:LIST:CURRent MAXimum

:LIST:CURRent MINimum

Query syntax:LIST:CURRent?

Return data1.000000E+00 (Format is in <NR3>)

When the Level setup is current mode, the data returns 9.9E37.

<Command> :LIST:SPEEd {MAXimum|FAST|MEDIUM|SLOW|SLOW2|0|1|2|3|4}
:LIST:SPEEd?

Function: It sets or queries the SPEED of list mode.

Description:

Set parameterMAXimum/0, FAST/1, MEDIUM/2, SLOW/, SLOW2/4

Set syntax:LIST:SPEEd 1

:LIST:SPEEd FAST

Query syntax:LIST:SPEEd?

Return data FAST (Format is in <disc>)

<Command> :LIST:DELAy <delay time NR3/disc>
:LIST:DELAy?

Function: It sets or queries the DELAY of list mode.

Description:

Set parameterThe range of delay time is {0.0~5|MAXimum|MINimum}.

Set syntax:LIST:DELAy 0.5

:LIST:DELAy 500M

:LIST:DELAy 500MS

:LIST:DELAy 5E-3

:LIST:DELAy MAXimum

:LIST:DELAy MINimum

Query syntax:LIST:DELAy?

Return data 0.500 (Format is in <NR2>)

<Command> :LIST:COMParator:MODE <ABSolute|DEVIation|PERCent|0|1|2>

Function: It sets or queries the COMP MODE of list mode.

Description:

Set parameterABSolute,0|DEVIation,1|PERCent,2

Set syntax:MEASure:COMParator:MODE PERCent

Query syntax:LIST:COMParator:MODE?

Return data PERC (Format is in <disc>)

<Command> :LIST:COMParator:NOMinal <nominal value NR3 >
:LIST:COMParator:NOMinal?

Function: It sets or queries the NOMINAL of list mode.

Description:

Set syntax:LIST:COMParator:NOMinal 1000
:LIST:COMParator:NOMinal 1K
:LIST:COMParator:NOMinal 1E+03
Query syntax:LIST:COMParator:NOMinal?
Return data 1.000000E+03 (Format is in <NR3>)

<Command> :LIST:COMParator:UPPER <upper limit NR3>
:LIST:COMParator:UPPER?

Function: It sets or queries the UPPER of list mode.

Description:

Set syntax:LIST:COMParator:UPPER 1
:LIST:COMParator:UPPER1000M
:LIST:COMParator:UPPER 1E+00
Query syntax:LIST:COMParator:UPPER?
Return data 1.000000E+00 (Format is in <NR3>)

<Command> :LIST:COMParator:LOWER <LOWER limit NR3>
:LIST:COMParator:LOWER?

Function: It sets or queries the LOWER of list mode.

Description:

Set syntax:LIST:COMParator:LOWER -1
:LIST:COMParator:LOWER -1000M
:LIST:COMParator:LOWER -1E+00
Query syntax:LIST:COMParator:LOWER?
Return data -1.000000E+00 (Format is in <NR3>)

<Command> :LIST:BIN:PARAMeter
{OFF|RDC|LS|LP|CS|CP|Q|D|RS|RP|Z|DEG|RAD|R|X|Y|G|B}
:LIST:BIN:PARAMeter?

Function: It sets or queries the BIN Parameter of list mode.,

Description:

Set syntax:LIST:BIN:PARAMeter Z(only allow the parameter which is being used under the list mode.)
Query syntax:LIST:PARAMeter?
Return data Z (Format is in <disc>)

<Command> :LIST:BIN:NUMBer {2|3|4|5|6|7|8|9|MAXium|MINimum}
:LIST:BIN:NUMBer?

Function: It sets or queries the BIN NUMBER of list mode.

Description:

Set parameterThe value of bin number is {2~9|MAXimum|MINimum}.
Set syntax:LIST:NUMBer 4
Query syntax:LIST:NUMBer?
Return data 4 (Format is in <NR1>)

<Command> :LIST:BIN:MEtHod {EQUal|SEQUential|TOLerance|RANDom|0|1|2|3}
:LIST:BIN:MEtHod?

Function: It sets or queries the BIN METHOD of list mode.

Description:

Set parameter EQUal,0| SEQUential,1|TOLerance,2 |RANDom,3

Set syntax:LIST:BIN:MEtHod SEQ

Query syntax:LIST:BIN:MEtHod?

Return data SEQ (Format is in <disc>)

<Command> :LIST:BIN:MODE <ABSolute|DEViation|PERCent|0|1|2>
:LIST:BIN:MODE?

Function: It sets or queries the BIN MODE of list mode.

Description:

Set parameter ABSolute,0|DEViation,1|PERCent,2

Set syntax:LIST:BIN:MODE DEViation

Query syntax:LIST:BIN:MODE?

Return data DEV (Format is in <disc>)

<Command> :LIST:BIN:NOMinal <nominal value NR3 >
:LIST:BIN:NOMinal?

Function: It sets or queries the BIN NOMINAL of list mode.

Description:

Set syntax:LIST:BIN:NOMinal 1000

:LIST:BIN:NOMinal 1K

:LIST:BIN:NOMinal 1E+03

Query syntax:LIST:BIN:NOMinal?

Return data 1.000000E+03 (Format is in <NR3>)

<Command> :LIST:BIN:LIMit <nominal value NR3 >
:LIST:BIN:LIMit?

Function: It sets or queries the BIN LIMIT of list mode.

Description:

Set syntax:LIST:BIN:BIN:LIMit 0.001,100M,1k,1000k

Query syntax:LIST:BIN:BIN:LIMit?

Return data +1.000000E-03, +1.000000E-01, +1.000000E+03, +1.000000E+06 (Format is in <NR3>)

<Command> :LIST:TRIGger:MODE {REPeat|SINGle|AUTO}
:LIST:TRIGger:MODE?

Function: It sets or queries the TRIGGER MODE of list mode.

Description:

Set parameter REPeat \ SINGLE \ AUTO

Set syntax:LIST:TRIGger:MODE AUTO

Query syntax:LIST:TRIGger:MODE?

Return data AUTO (Format is in <disc>)

<Command> :LIST:TRIGger:DElay <delay time NR3/disc>
:LIST:TRIGger:DElay?

Function: It sets or queries the TRIGGER DELAY of list mode.

Description:

Set parameter The value of delay time is {0.0~5|MAXimum|MINimum}.

Set syntax:LIST:TRIGger:DElay 0.5
:LIST:TRIGger:DElay 500M
:LIST:TRIGger:DElay 500MS
:LIST:TRIGger:DElay 5E-3
:LIST:TRIGger:DElay MAXimum
:LIST:TRIGger:DElay MINimum

Query syntax:LIST:TRIGger:DElay?

Return data 0.500 (Format is in <NR2>)

<Command> :LIST:OIMPedance {100|25}
:LIST:OIMPedance?

Function: It sets or queries the RO of list mode.

Description:

Query syntax:LIST:OIMPedance?

Return data 100|25 (Format is in <NR1>)

<Command> :LIST:ALC {OFF|ON|0|1}

Function: It sets or queries the ALC of list mode.

Description:

Query syntax :LIST:ALC?

Return data When the setup is OFF, it returns 0.

When the setup is ON, it returns 1.

<Command> :LIST:BEEPer {OFF|PASS|OK|FAIL|NG|0|1|2}
:LIST:BEEPer?

Function: It sets or queries the BEEP WHEN of list mode.

Description:

Set parameter OFF, PASS|OK, FAIL|NG

Set syntax:LIST:BEEPerPASS

:LIST:BEEPer NG

:LIST:BEEPer OFF

Query syntax:LIST:BEEPer?

Return data PASS |FAIL |OFF (Format is in <disc>)

<Command> :LIST:RANGe {AUTO|HOLD|0|1}
:LIST:RANGe?

Function: It sets or queries the RANGE of list mode.

Description:

Set parameter If selecting <ON>, the measuring range is hold at the range, which is used by the first time measuring. If selecting <OFF>, the most suitable test range is set automatically.

Set syntax:LIST:RANGe AUTO

:LIST:RANGe 1

Query syntax:LIST:RANGe?

Return data AUTO |HOLD (Format is in <disc>)

<Command> :LIST:RETest {OFF|STEP|ALL|0|1|2}
:LIST:RETest?

Function: It sets or queries the FAIL RETEST of list mode.

Description:

Set parameterIt retests continuously until the test result is pass, when the test result is fail. If selecting <OFF>, it doesn't execute this function. If selecting <STEP 1>, only the first step is going to retest. If selecting <ALL>, no matter which step occur fail result, the fail step is going to retest until the result become pass.

Set syntax:LIST:RETest STEP
:LIST:RETest 2
:LIST:RETest OFF

Query syntax:LIST:RETest?

Return dataOFF | STEP |ALL (Format is in <disc>)

<Command> :LIST:UPLoad {0|1}
:LIST:UPLoad?

Function: It sets or queries the auto upload of list mode.

Description:

Set parameterIf it gives <0>, it closed the upload function. If it gives <1>, it opens the upload function.It uploads the list test data automatically, when the upload function is opening.If you abort the list test, it won't upload the test data.

<Command> :LCORrection:OPEN
:LCORrection:OPEN?

Function: It sets or queries to do the open correction of list mode.

Description: :LCORrection:OPEN?

Querysyntax:LCORrection:OPEN?

Return data When correction fail, it returns 0.

When correction passes, it returns 1.

<Command> :LCORrection:SHORT
:LCORrection:SHORT?

Function: It sets or queries to do the short correction of list mode.

Description:

Query syntax:LCORrection:SHORT?

Return data When correction fail, it returns 0.

When correction passes, it returns 1.

<Command> :LCORrection:OPEN:STATe {OFF|ON|0|1}
:LCORrection:OPEN:STATe?

Function: It sets or queries the open correction status of list mode.

Description:

Query syntax:LCORrection:OPEN:STATe?

Return data When the setup is OFF, it returns 0.

When the setup is ON, it returns 1.

<Command> :LCORrection:SHORT:STATe {OFF|ON|0|1}
:LCORrection:SHORT:STATe?

Function: It sets or queries the short correction status of list mode.

Description:

Query syntax:LCORrection:SHORT:STATe?

Return data When the setup is OFF, it returns 0.

When the setup is ON, it returns 1.

<Command> :LCORrection:CABLe {0|0.5|1|2}
:LCORrection:CABLe?

Function: It sets or queries the status of cable length correction.

Description:

Query syntax:LCORrection:CABLe?

Return data 0|0.5|1|2

<Command> :LIST:FILE:LOAD <filename>

Function: It opens the list mode's file.

Description:

Set syntax:MEASure:FILE:LOAD MATRIX.(open the MATRIX list mode file)

<Command> :LIST:FILE:LOAD?

Function: It queries the list mode's filename which is being using.

Description:

Query syntax:MEASure:FILE:LOAD?

Return data MATRIX

<Command> :LIST:BIAS:VOLTage <NR3>

Function: It sets the BIAS Voltage of list mode.

Description:

Query syntax: LIST:BIAS:VOLTage 6

<Command> :LIST:BIAS:VOLTage?

Function: It queries the BIAS Voltage of list mode

Description:

Query syntax: LIST:BIAS:VOLTage?

Return data +6.000000E+00

◆ SWEep Subsystem

<Command> :SWEep:TYPE {FREQuency|VAC|IAC}
:SWEep:TYPE?

Function: It sets or queries the TYPE.

Description:

Set parameter FREQuency | VAC(voltage) | IAC(current)

Set syntax :SWEep:TYPE FREQuency

Query syntax:LIST:RETest?

Return data FREQ | VAC | IAC (Format is in <disc>)

<Command> :SWEep:XAXis {LOGarithm|LINear}
:SWEep:XAXis?

Function: It sets or queries the XAXIS.

Description:

Set parameter LOGarithm | LINear

Set syntax:SWEep:XAXis LOGarithm

Query syntax:SWEep:XAXis?

Return data LOG | LIN (Format is in <disc>)

<Command> :SWEep:XAXis:DATA?

Function: It queries the XAXIS data.

Description:

Query syntax:SWEep:XAXis:DATA?

Return

data+1.000000E+03,+1.209960E+05,+2.409920E+05,+3.609880E+05,...+3.000000E+07(Format is in <NR3>)

<Command> :SWEep:START <startNR3/disc>
:SWEep:START?

Function: It sets or queries the START.

Description:

Set parameter The start value of frequency is {10.0~30000000.0|MAXimum|MINimum}.

The start value of voltage AC RO 100Ω is {0.01~2|MAXimum|MINimum}.

The start value of voltage AC RO 25Ω is {0.01~1|MAXimum|MINimum}.

The start value of current AC RO 100Ω is {0.0002~0.02|MAXimum|MINimum}.

The start value of current AC RO 25Ω is {0.0002~0.04|MAXimum|MINimum}.

Set syntax:SWEep:START 0.5

:SWEep:START 500M

:SWEep:START 5E-3

:SWEep:START MAXimum

:SWEep:START MINimum

Query syntax:SWEep:START?

Return data+5.000000E-01(Format is in <NR3>)

<Command> :SWEep:STOP <stopNR3/disc>
:SWEep:STOP?

Function: It sets or queries the STOP.

Description:

Set parameterThe stop value of frequency is {10.0~30000000.0|MAXimum|MINimum}.
The stop value of voltage AC RO 100Ω is {0.01~2|MAXimum|MINimum}.
The stop value of voltage AC RO 25Ω is {0.01~1|MAXimum|MINimum}.
The stop value of current AC RO 100Ω is {0.0002~0.02|MAXimum|MINimum}.
The stop value of current AC RO 25Ω is {0.0002~0.04|MAXimum|MINimum}.

Set syntax:SWEep:START 0.5
:SWEep:START 500M
:SWEep:START 5E-3
:SWEep:START MAXimum
:SWEep:START MINimum

Query syntax:SWEep:START?

Return data+5.000000E-01(Format is in <NR3>)

<Command> :SWEep:FREQuency<frequencyNR3/disc>
:SWEep:FREQuency?

Function: It sets or queries the FREQ, when the TYPE setup is VAC or IAC.

Description:

Set parameterThe value of frequency is {10.0~30000000.0|MAXimum|MINimum}.

Set syntax:SWEep:FREQuency 1000
:SWEep:FREQuency 1K
:SWEep:FREQuency 1KHZ
:SWEep:FREQuency 1E3
:SWEep:FREQuency MAXimum
:SWEep:FREQuency MINimum

Query syntax:SWEep:FREQuency?

Return data 1.000000E+03(Format is in <NR3>)

When the TYPE setup is FREQuency mode, the data returns 9.9E37.

<Command> :SWEep:VOLTage <voltage NR3/disc>
:SWEep:VOLTage?

Function: It sets or queries the LEVEL to voltage mode, when the TYPE setup is FREQ.

Description:

Set parameterThe value of voltage AC RO 100Ω is {0.01~2|MAXimum|MINimum}.
The value of voltage AC RO 25Ω is {0.01~1|MAXimum|MINimum}.

Set syntax:SWEep:VOLTage 1
:SWEep:VOLTage 1M
:SWEep:VOLTage 1MV
:SWEep:VOLTage 1E-3
:SWEep:VOLTage MAXimum
:SWEep:VOLTage MINimum

Query syntax:SWEep:VOLTage?

Return data 1.000000E+03(Format is in <NR3>)

When the LEVEL setup is not voltage mode, the data returns 9.9E37.

<Command> :SWEep:CURRent<currentNR3/disc>
:SWEep:CURRent?

Function: It sets or queries the LEVEL to current mode, when the TYPE setup is FREQ.

Description:

Set parameter The value of current AC RO 100Ω is {0.0002~0.02|MAXimum|MINimum}.

The value of current AC RO 25Ω is {0.0002~0.04|MAXimum|MINimum}.

Set syntax: SWEep:CURRent 1

:SWEep:CURRent 1M

:SWEep:CURRent 1MA

:SWEep:CURRent 1E-3

:SWEep:CURRent MAXimum

:SWEep:CURRent MINimum

Query syntax: SWEep:CURRent?

Return data 1.000000E+03 (Format is in <NR3>)

When the LEVEL setup is not current mode, the data returns 9.9E37.

<Command> :SWEep:TRIGger:MODE <REPeat|SINGle|0|1>
:SWEep:TRIGger:MODE?

Function: It sets or queries the TRIG.

Description:

Set parameter REPeat, 0 (repeat) · SINGle, 1 (single)

Set syntax: SWEep:TRIGger:MODE SINGle

Query syntax: SWEep:TRIGger:MODE?

Return data REP | SING (Format is in <disc>)

<Command> :SWEep:SPEEd {FAST|MEDIum|SLOW|1|2|3}
:SWEep:SPEEd?

Function: It sets or queries the SPEED.

Description:

Set parameter FAST/1, MEDIum/2, SLOW/3

Set syntax: SWEep:SPEEd 1

:SWEep:SPEEd FAST

Query syntax: SWEep:SPEEd?

Return data FAST | MED | SLOW (Format is in <disc>)

<Command> :SWEep:TRACe {A|B}
:SWEep:TRACe?

Function: It sets or queries which trace is on using.

Description:

Set syntax: SWEep:TRACe A

Query syntax: SWEep:TRACe?

Return data A | B (Format is in <disc>)

<Command> :SWEep:FUNctIon
{LS|LP|CS|CP|Q|D|RS|RP|Z|DEG|RAD|R|X|Y|G|B,OFF|LS|LP|CS|CP|Q|D|RS|RP|Z
|DEG|RAD|R|X|Y|G|B }
:SWEep:FUNctIon?

Function: It sets or queries the FUNC.

Description:

Set parameter The comma is placed between the two parameters. The first parameter can not set to OFF. There is no RDC(DC Resistance), E(Relative Permittivity) and U(Relative permeability) in the sweep mode.

Set syntax: SWEep:FUNctIon Z,DEG

Query syntax: SWEep:FUNctIon?

Return data Z,DEG (Format is in <disc>)

<Command> :SWEep:ANALySis:MODEl {A|B|C|D|E|F|G|OFF}
:SWEep:ANALySis:MODEl?

Function: It sets or queries the ANALYSIS MODEL.

Description:

Set syntax: SWEep:ANALySis:MODEl B

Query syntax: SWEep:ANALySis:MODEl?

Return data B (Format is in <disc>)

<Command> :SWEep:DELay <delay timeNR3/disc>
:SWEep:DELay?

Function: It sets or queries the SWEEP DELAY.

Description:

Set parameter The value of delay time is {0.0~5|MAXimum|MINimum}.

Set syntax: SWEep:DELay 0.5

:SWEep:DELay 500M

:SWEep:DELay 500MS

:SWEep:DELay 5E-3

:SWEep:DELay MAXimum

:SWEep:DELay MINimum

Query syntax: SWEep:DELay?

Return data 0.500 (Format is in <NR2>)

<Command> :SWEep:OIMPedance {100|25}
:SWEep:OIMPedance?

Function: It sets or queries the OUTPUT IMPEDANCE.

Description:

Query syntax: SWEep:OIMPedance?

Return data 100|25 (Format is in <NR1>)

<Command> :SWEep:KEEP {OFF|ON|0|1}
:SWEep:KEEP?

Function: It sets or queries the KEEP PREVIOUS TRACE.

Description:

Set syntax: SWEep:KEEP ON

:SWEep:KEEP 0

Query syntax: SWEep:KEEP?

Return data ON | OFF (Format is in <disc>)

<Command> :SWEep:TRACA:PARAMeter
{LS|LP|CS|CP|Q|D|RS|RP|Z|DEG|RAD|R|X|Y|G|B}
:SWEep:TRACA:PARAMeter?

Function: It sets or queries the PARA of TRACE A

Description:

Set parameter The first parameter can't set to OFF. There is no RDC(DC Resistance), E(Relative Permittivity) and U(Relative permeability) in the sweep mode.

Set syntax:SWEep:TRACA:PARAMeter Z

Query syntax:SWEep:TRACA:PARAMeter?

Return data Z (Format is in <disc>)

<Command> :SWEep:TRACA:YAXis {LOGarithm|LINear}
:SWEep:TRACA:YAXis?

Function: It sets or queries the Y-AXIS of TRACE A.

Description:

Set parameter LOGarithm | LINear

Set syntax:SWEep:TRACA:YAXis LOGarithm

Query syntax:SWEep:TRACA:YAXis?

Return data LOG | LIN (Format is in <disc>)

<Command> :SWEep:TRACA:REFerence <value NR3>
:SWEep:TRACA:REFerence?

Function: It sets or queries the REF of TRACE A.

Description:

Set parameter It can set the value, when Y-AXIS setup is linear mode.

Set syntax:SWEep:TRACA:REFerence 25k

Query syntax:SWEep:TRACA:REFerence?

Return data 2.500000E+03 (Format is in <NR3>)

<Command> :SWEep:TRACA:POSition {-10 ~ 16|MAXimum|MINimum}
:SWEep:TRACA:POSition?

Function: It sets or queries the POS of TRACE A.

Description:

Set parameter {-10 ~ 16|MAXimum|MINimum}

Set syntax:SWEep:TRACA:POSition -3

Query syntax:SWEep:TRACA:POSition?

Return data -3 (Format is in <NR1>)

<Command> :SWEep:TRACA:DIVision <value NR3/disc>
:SWEep:TRACA:DIVision?

Function: It sets or queries the DIV of TRACE A.

Description:

Set parameter The numeric value can only set 1, 2, 5 and 10 (when Y-axis setup is linear mode).

Set syntax:SWEep:TRACA:DIVision 2k

Query syntax:SWEep:TRACA:DIVision?

Return data 2.000000E+03 (Format is in <NR3>)

<Command> :SWEep:TRACA:DECade {1~12}
:SWEep:TRACA:DECade?

Function: It sets or queries the DECADE of TRACE A.

Description:

Set parameter The value of DECADE is {1~12} (when Y-axis setup is LOG mode).

Set syntax: SWEep:TRACA:DECade 5
Querysyntax: SWEep:TRACA:DECade?
Return data 5 (Format is in <NR3>).

<Command> :SWEep:TRACA:MAXimun?

Function : It queries the maximum of TRACE A and corresponding frequency | voltage | current.

Description:

Query syntax: SWEep:TRACA:MAXimun?

Return data +2.230924E+06,+3.221517E-03 (Format is in <NR3>).The first data is the corresponding frequency | voltage | current. The second data is the maximum.

<Command> :SWEep:TRACA:MINimum?

Function: It queries the minimum of TRACE A and corresponding frequency | voltage | current.

Description:

Query syntax: SWEep:TRACA:MINimum?

Return data +2.310130E+06,-3.446227E-03 (Format is in <NR3>).The first data is the corresponding frequency | voltage | current. The second data is the minimum.

<Command> :SWEep:TRACA:RESult?

Function: It queries all of the value data of TRACE A.

Description:

Query syntax: SWEep:TRACA: RESult?

Return data +2.218913E-04,+2.215632E-04,+2.216804E-04...(Format is in <NR3>).

<Command> :SWEep:TRACB:PARAMeter

{LS|LP|CS|CP|Q|D|RS|RP|Z|DEG|RAD|R|X|Y|G|B|}

:SWEep:TRACA:PARAMeter?

Function: It sets or queries the PARA of TRACE B

Description:

Set parameterThe first parameter can not set to OFF. There is no RDC(DC Resistance), E(Relative Permittivty) and U(Relative permeability) in the sweep mode.

Set syntax: SWEep:TRACB:PARAMeter Z

Querysyntax: SWEep:TRACB:PARAMeter?

Return data Z (Format is in <disc>)

<Command> :SWEep:TRACB:YAXis {LOGarithm|LINear}

:SWEep:TRACB:YAXis?

Function: It sets or queries the Y-AXIS of TRACE A.

Description:

Set parameterLOGarithm | LINear

Set syntax: SWEep:TRACB:YAXis LOGarithm

Querysyntax: SWEep:TRACB:YAXis?

Return data LOG | LIN (Format is in <disc>)

<Command> :SWEep:TRACB:REFerence <value NR3>

:SWEep:TRACB:REFerence?

Function: It sets or queries the REF of TRACE B.

Description:

Set parameterIt can set the value, when Y-AXIS setup is linear mode.

Set syntax: SWEep:TRACB:REFerence 25k

Querysyntax: SWEep:TRACB:REFerence?

Return data 2.500000E+03 (Format is in <NR3>)

<Command> :SWEep:TRACB:POSition {-10 ~ 16|MAXimum|MINimum}
:SWEep:TRACB:POSition?

Function: It sets or queries the POS of TRACE B.

Description:

Set parameter{-10 ~ 16|MAXimum|MINimum}
Set syntax:SWEep:TRACB:POSition -3
Query syntax:SWEep:TRACB:POSition?
Return data -3 (Format is in <NR1>)

<Command> :SWEep:TRACB:DIVision <value NR3/disc>
:SWEep:TRACB:DIVision?

Function: It sets or queries the DIV of TRACE B.

Description:

Set parameter The numeric value can only set 1, 2, 5 and 10(when Y-axis setup is linear mode).
Set syntax:SWEep:TRACB:DIVision 2k
Query syntax:SWEep:TRACB:DIVision?
Return data 2.000000E+03 (Format is in <NR3>)

<Command> :SWEep:TRACB:DECade {1~12}
:SWEep:TRACB:DECade?

Function: It sets or queries the DECADE of TRACE B.

Description:

Set parameter The value of DECADE is {1~12} (when Y-axis setup is LOG mode).
Set syntax:SWEep:TRACB:DECade 5
Query syntax:SWEep:TRACB:DECade?
Return data 5 (Format is in <NR3>).

<Command> :SWEep:TRACB:MAXimum?

Function : It queries the maximum of TRACE B and corresponding frequency | voltage | current.

Description:

Querysyntax:SWEep:TRACB:MAXimum?
Return data +2.230924E+06,+3.221517E-03 (Format is in <NR3>).The first data is the corresponding frequency | voltage | current. The second data is the maximum.

<Command> :SWEep:TRACB:MINimum?

Function: It queries the minimum of TRACE B and corresponding frequency | voltage | current.

Description:

Query syntax:SWEep:TRACB:MINimum?
Return data +2.310130E+06,-3.446227E-03 (Format is in <NR3>).The first data is the corresponding frequency | voltage | current. The second data is the minimum.

<Command> :SWEep:TRACB:RESult?

Function: It queries all of the value data of TRACE B.

Description:

Query syntax:SWEep:TRACB: RESult?
Return data +2.218913E-04,+2.215632E-04,+2.216804E-04...(Format is in <NR3>).

<Command> :SWEep:AUToscale

Function: It does the AUTO FIT function.

<Command> :SWEep:RESult?

Function: It queries all of the value data of TRACE A and TRACE B.

Description:

Query syntax:SWEep:RESult?

Return data+2.218913E-04,+2.215632E-04,+2.216804E-04...(Format is in <NR3>). It uploads the TRACE A data at the beginning. It start uploading TRACE B data when finish uploading TRACE A data.

<Command> :SWEep:ANALysis:RESult?

Function: : It queries all of the value data and corresponding frequency | voltage | current of TRACE A and TRACE B.

Description:

Query syntax:SWEep:ANALysis:RESult?

Return data +1.000000E+03 , +2.212126E-04 , +1.398695E+00 , +1.035500E+03 , +2.209532E-04 , +1.446218E+00...(Format is in <NR3>). It uploads the TRACE A data at the beginning. It start uploading TRACE B data when finish uploading TRACE A data.

<Command> :SWEep:ANALysis:CALCulate?

Function: It queries the data of R1, L1, C1, C0 and R0 which are in the ANALYSIS mode.

Description:

Query syntax:SWEep:ANALysis:CALCulate?

Return data +1.076054E+05 , +2.209770E-04 , +2.138633E-11 , +1.588589E-01 (Format is in <NR3>).

<Command> :SWEep:SRF:SERies?

Function: It queries the SRF fs (self-resonant frequency serial).

Description:

Query syntax:SWEep:SRF:SERies?

Return data +2.310130E+06 (Format is in <NR3>).

<Command> :SWEep:SRF:PARallel?

Function: It queries the SRF fp (self-resonant frequency parallel).

Description:

Query syntax:SWEep:SRF:PARallel?

Return data +2.310130E+06 (Format is in <NR3>).

<Command> :SWEep:BIAS:VOLTage<NR3>

Function: It sets the BIAS Voltage of sweep Mode.

Description:

Query syntax: SWEep:BIAS:VOLTage 3

Return data:+3.000000E+00

<Command> :SWEep:BIAS:VOLTage?

Function: It queries the BIAS Voltage of sweep Mode.

Description:

Query syntax: SWEep:BIAS:VOLTage?

◆ Read the measured value

Read the measured value

Read Data format under Meter Mode

<para 1 data>,<para 2 data>,<para 3 data>,<para 4 data>,<status>,<bin number>,<para 1 compare status>,<para 2 compare status>,<para 3 compare status>,<para 4 compare status>

para 1-4 data

During value measuring, not all of four values will be displayed. The value will be displayed when the opening display parameters are available. For example, if only two parameters are opened, then only two count of value will be transmitted.

status – Measuring status, and the weighted value of each status refers to the final value.

0 – Normal status without special status and without comparison.

1 – Measuring schedule error

2 – ALC error

4 – Other errors

8 – Reserve

16 – All parameters OK

32 – Some parameters NG

bin number – Categorization result, and such value will not be displayed when closing the bin function.

-1 – bin out, not in the categorization number

1 – 9 – bin number, the categorization result is 1-9.

para compare status 1-4

Measuring comparison result: If any parameter comparison function is opened, then the comparison result will be displayed for all of the opened parameters.

0 – No comparison

1 – Parameter comparison result OK

2 – Parameter comparison result NG

Value transmit mode under Multi-step Test Mode.

<result>,<direction>,<bin number>,<step 1 result>,<step 1 data>,<step 2 result>,<step 2 data>,<step 3 result>,<step 3 data>.....<step n result>,<step n data>

result – Finally judged test result

0 – Test not interrupted. Not completed

1 – Test steps all OK

2 – NG occurs to the test step

bin number - categorization result, and such value will not be displayed when closing the bin function.

-1 - bin out not in the categorization number

1-9 - bin number the categorization result is 1-9

step result

0 – no test

1 – test OK

2 – test NG

step data

test value

Measurement Basics

To measure capacitance, inductance and resistance user can select series or parallel mode.

C(Capacitance) :

Series mode:



Series modeEquations:

D = dissipation factor

Parallel mode:

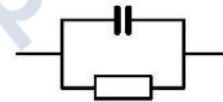

Parallel modeEquations:

D = dissipation factor

L(Inductance) :

Series mode:



Series modeEquations:

Q = Quality Factor

Parallel mode:

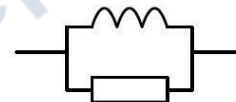

Parallel modeEquations:

Q = Quality Factor

R (Resistance) :

Series mode:

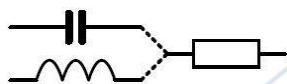

Series modeEquations:

Q = Quality Factor

Parallel mode:

Parallel modeEquations:

Q = Quality Factor

◆ Resistance (R) and Conductance (G)

The resistance is a measure of the difficulty to pass an electric current through that conductor. The SI unit of resistance is the “ohm” (Ω). The inverse quantity is electrical conductance, and this is the ease with which an electric current passes through a circuit. The SI unit of conductance is measured in Siemens (S) and it the reciprocal of the resistance ($G=1/R$).

● Resistance (R)

Measure Type: Series mode $\rightarrow R_s$ / Parallel mode $\rightarrow R_p$ / DC mode $\rightarrow R_{dc}$

Relevant Equations:

$$R = \frac{V}{I} = \frac{1}{G} = Z_s - jX = Z_s - j\omega L = Z_s + \frac{j}{\omega C}$$

$$|Z_s| = \sqrt{(R^2 + X^2)}$$

$$|Z_p| = \frac{RX}{\sqrt{(R^2 + X^2)}}$$

$$R_s = |Z| \cos \theta$$

● Conductance (G)

Measure Type: Parallel mode $\rightarrow G_p$ (Conductance is measuring by parallel mode only.)

Relevant Equations:

$$G_p = \frac{I}{V} = \frac{1}{R} = Y_p - jB = Y_p - j\omega C = Y_p + \frac{j}{\omega L}$$

$$|Y_s| = \frac{GB}{\sqrt{(G^2 + B^2)}}$$

$$|Y_p| = \sqrt{(G^2 + B^2)}$$

$$G_p = |Y| \cos \theta$$

◆ Capacitance (C)

Capacitance (denoted by the letter C) is the ability of a body to store an electrical charge at a given potential difference between its plates. The SI unit of capacitance is the farad (symbol: F).

Measure Type: Series mode→Cs / Parallel mode→Cp

Relevant Equations:

$$Z_s = R + jX = R + j\omega L = R - \frac{j}{\omega C}$$

$$Y_p = G + jB = G + j\omega C = G - \frac{j}{\omega L}$$

$$Q = \frac{\omega L_s}{R_s} = \frac{1}{\omega C_s R_s} \quad (\text{series R, L, C values})$$

$$Q = \frac{R_p}{\omega L_p} = \omega C_p R_p \quad (\text{parallel R, L, C values})$$

$$D = \frac{R_s}{\omega L_s} = \omega C_s R_s \quad (\text{series R, L, C values})$$

$$D = \frac{G_p}{\omega C_p} = \omega L_p G_p \quad (\text{parallel G, L, C values})$$

◆ **Inductance (L)**

Inductance is the property of an electrical conductor by which a change in current through it induces an electromotive force (EMF) in both the conductor itself and in any nearby conductors by mutual inductance. In the SI system, the measurement unit for inductance is the Henry (with the unit symbol H).

Measure Type: Series mode→Cs / Parallel mode→Cp

Relevant Equations:

$$Z_s = R + jX = R + j\omega L = R - \frac{j}{\omega C}$$

$$Y_p = G + jB = G + j\omega C = G - \frac{j}{\omega L}$$

$$Q = \frac{\omega L_s}{R_s} = \frac{1}{\omega C_s R_s} \quad (\text{series R, L, C values})$$

$$Q = \frac{R_p}{\omega L_p} = \omega C_p R_p \quad (\text{parallel R, L, C values})$$

$$D = \frac{R_s}{\omega L_s} = \omega C_s R_s \quad (\text{series R, L, C values})$$

$$D = \frac{G_p}{\omega C_p} = \omega L_p G_p \quad (\text{parallel G, L, C values})$$

◆ Reactance (X) and Susceptance (B)

In AC circuit analysis, reactance is represented by the capital letter “X” which is the imaginary part of complex impedance. Reactance is the opposition of a circuit element to a change in the current or voltage, due to that element's inductance or capacitance which is similar to the opposition of resistance to current in a DC circuit. In an AC circuit (e.g. a series RLC circuit) inductance and capacitance may oppose current and are named reactance measured in units of Ohm (Ω).

In electrical engineering, susceptance (B) is the imaginary part of admittance. The inverse of admittance is impedance, and the real part of admittance is conductance. The latter is the reciprocal of impedance ($B=1/X$) and is measured in units of Siemens (S).

- Reactance (X):

Measure Type: Series mode→ X_s (Reactance is measuring by series mode only.)

Relevant Equations:

$$X = \frac{1}{B} = |Z| \sin \theta$$

$$|Z_s| = \sqrt{(R^2 + X^2)}$$

$$|Z_p| = \frac{RX}{\sqrt{(R^2 + X^2)}}$$

$$X_s = |Z| \sin \theta$$

- Susceptance (B):

Measure Type: parallel mode→ B_p (Reactance is measuring by parallel mode only.)

Relevant Equations:

$$B = \frac{1}{X} = |Y| \sin \theta$$

$$|Y_s| = \frac{GB}{\sqrt{(G^2 + B^2)}}$$

$$|Y_p| = \sqrt{(G^2 + B^2)}$$

$$B_p = |Y| \sin \theta$$

◆ Impedance (Z) and Admittance (Y)

The impedance covers oppositions in AC circuits including resistance, inductance, and capacitance and is measured in units of Ohm (Ω).

In electrical engineering, admittance covers both conductance and susceptance and is the reciprocal of impedance. It is measured in units of Siemens (S).

- Impedance (Z):

Relevant Equations:

$$Z = \frac{E}{I} = \frac{1}{Y}$$

$$Z_s = R + jX = R + j\omega L = R - \frac{j}{\omega C}$$

$$|Z_s| = \sqrt{(R^2 + X^2)}$$

$$|Z_p| = \frac{RX}{\sqrt{(R^2 + X^2)}}$$

$$R_s = |Z| \cos \theta$$

$$X_s = |Z| \sin \theta$$

- Admittance (Y):

Relevant Equations:

$$Y = \frac{I}{E} = \frac{1}{Z}$$

$$Y_p = G + jB = G + j\omega C = G - \frac{j}{\omega L}$$

$$|Y_s| = \frac{GB}{\sqrt{(G^2 + B^2)}}$$

$$|Y_p| = \sqrt{(G^2 + B^2)}$$

$$G_p = |Y| \cos \theta$$

$$B_p = |Y| \sin \theta$$

◆ **Quality factor (Q) and Dissipation factor (D)**

The quality factor measures energies consumed by relative frequency. In general, the better a circuit's quality factor the better its selectivity.

The dissipation factor is the reciprocal of quality factor. It is the signal angle loss by a capacitor (or inductor) and acting frequency at a fixed temperature. Phase shifts caused by time lag between an externally applied voltage and current generated may result in loss of current and energy dissipation. Here the total current (I) is the sum of the charging current (I_c) by a 90° voltage phase shift and loss current (I_R) of the same voltage. The loss angle is the angle δ between the total current and charging current and tanδ the dissipation factor (symbol: D) as shown in the figure below:

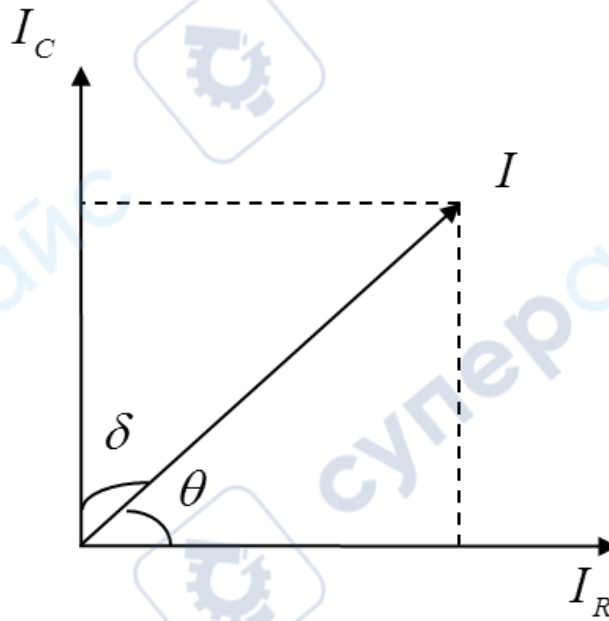

- Quality factor (Q)

Relevant Equations:

$$Q = \frac{R_p}{\omega L_p} = \omega C_p R_p \quad (\text{series R, L, C values})$$

$$Q = \frac{\omega L_s}{R_s} = \frac{1}{\omega C_s R_s} \quad (\text{series R, L, C values})$$

$$Q = \frac{1}{\tan(90 - \theta)^\circ} = \frac{1}{D}$$

- Dissipation factor (D)

Relevant Equations:

$$D = \frac{R_s}{\omega L_s} = \omega C_s R_s$$

$$D = \frac{G_p}{\omega C_p} = \omega L_p G_p$$

$$D = \tan(90 - \theta)^\circ = \frac{1}{Q}$$

◆ Phase angle (θ)

This is the shift angle when measuring impedance (Z), admittance (Y), quality factor (Q) and dissipation factor (D).

Relevant equations:

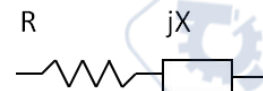
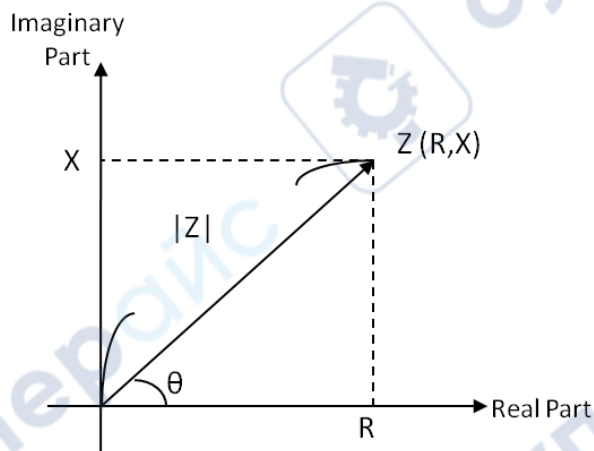

$$Z = R + jX = |Z| \angle \theta$$

$$\begin{cases} R = |Z| \cos \theta \\ X = |Z| \sin \theta \end{cases}$$

$$\begin{cases} |Z| = \sqrt{R^2 + X^2} \\ \theta = \tan^{-1} \left(\frac{X}{R} \right) \end{cases}$$

◆ Overall Impedance Measurement Theory

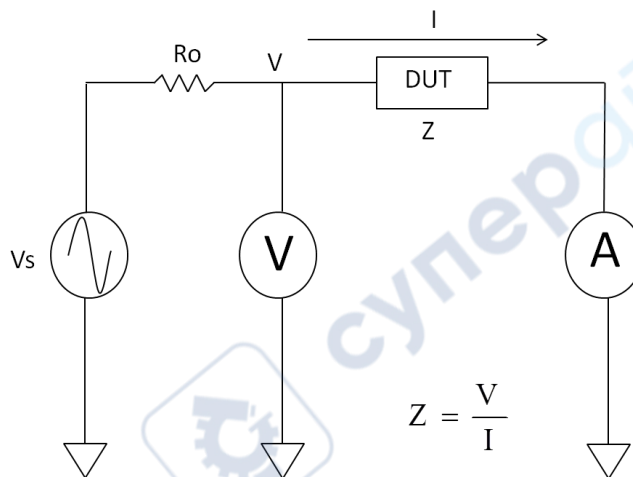

The simplified model of the 9030 impedance measurement, V_s is the test signal voltage and R_o is source resistance. If the current across the DUT is I when a test signal voltage V is applied, the DUT's impedance, Z , is expressed by $Z = \frac{V}{I}$.

Impedance, Z , contains real and imaginary parts. The figure shows vector representation of impedance as follow.

- R: Resistance
- X: Reactance
- $|Z|$: Impedance
- θ : Phase Angle

Impedance, Z, can also be expressed as admittance, Y. Admittance is expressed in terms of impedance, Z, by $Y = \frac{1}{Z}$.

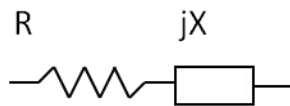

$$Y = \frac{1}{Z}$$

OR

$$Y = \frac{1}{R + jX}$$

For parallel connected circuits, it is better to use admittance, Y.

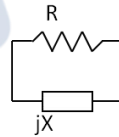
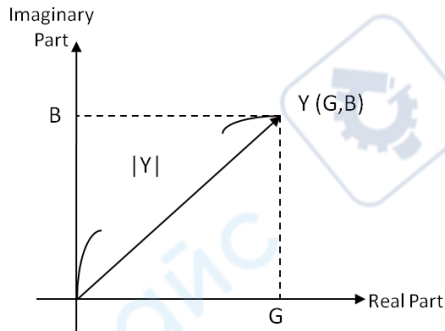

$$Z = \frac{jRX}{R + jX} = \frac{RX^2}{R^2 + X^2} + j \frac{R^2X}{R^2 + X^2}$$

(Impedance make it a bit complex)

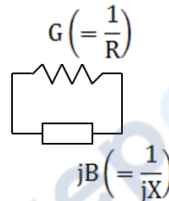

$$Y = G + jB$$

G : Conductance

B : Susceptance

|Y|: Admittance

The 9030 measures a DUT's impedance, Z, which is a vector value, and gives the result using the following equivalent circuits.

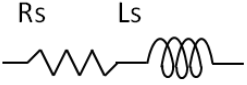
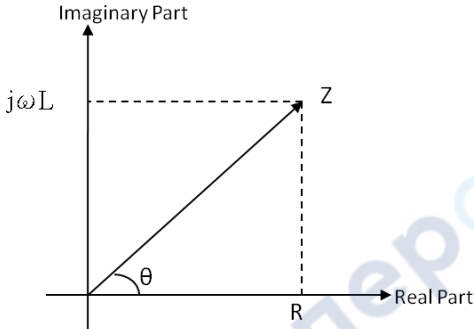
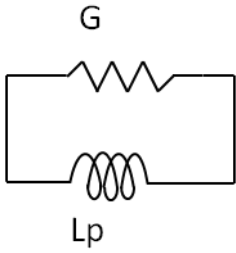
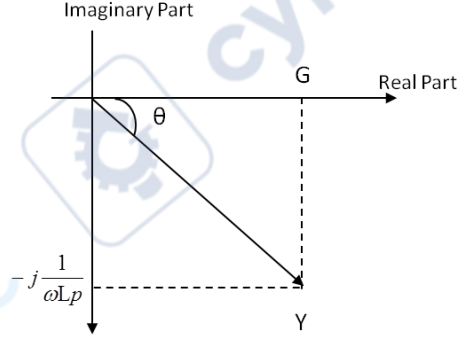
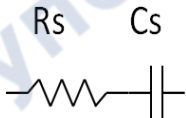
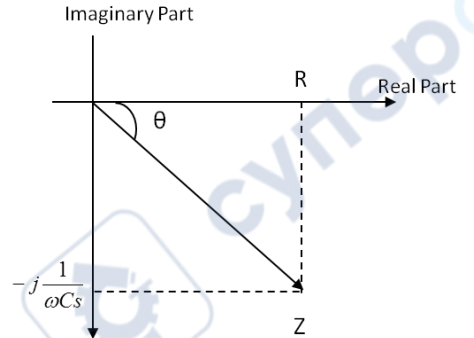
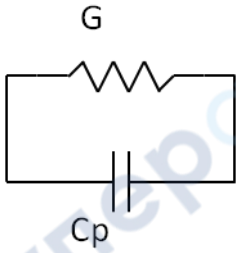
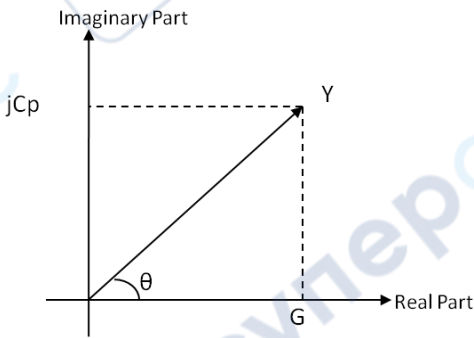
		$Z = R_s + jX = Z \angle \theta$ $X = \omega L_s$ $Z = R_s + j \omega L_s$ <p>Where $\omega = 2 \pi f$ (f : test frequency)</p>
		
		$Z = R_s + jX = Z \angle \theta$ $X = -j \frac{1}{\omega C_s}$ $Z = R_s - j \frac{1}{\omega C_s}$ <p>Where $\omega = 2 \pi f$ (f : test frequency)</p>
		$Y = G + jB$ $B = \omega C_p$ $Y = G - j \omega C_p$ <p>Where $\omega = 2 \pi f$ (f : test frequency)</p>
$Q = \frac{1}{D} = \frac{1}{\tan \delta} = \frac{X_L}{R} = \frac{-X_C}{R} = \frac{-B_L}{G} = \frac{B_C}{G}$		

Lp : Parallel Inductance
Ls : Series Inductance
Q : Quality factor

Cp : Parallel Capacitance
Cs : Series Capacitance
D : Dissipation factor

◆ Characteristics Example

As can be seen in the following figure, a component can have different effective parameter values dependent upon its operating condition. The measured values most useful in actual applications are obtained from precise measurement under the actual operating conditions.

Dut	Characteristics Example	Measurement Functions
Large C		Cs-Rs Cs-D Cs-Q R-X $ Z -\angle\theta$
Small C		Cp-G Cp-D Cp-Q G-B Y- $\angle\theta$
Large L		Lp-G Lp-D Lp-Q G-B Y- $\angle\theta$
Small L		Ls-Rs Ls-D Ls-Q R-X $ Z -\angle\theta$

Dut	Characteristics Example	Measurement Functions
Large R		Cp-G G-B Y- $\angle\theta$
Small R		Ls-Rs R-X Z - $\angle\theta$

◆ **High and low impedance criteria**

The following criteria can be used to roughly discriminate between low, middle, and high impedances by following figure. The medium Z range may be covered with an extension of either the low Z or high Z range. These criteria differ somewhat, depending on the frequency and component type.

In the frequency region where the primary capacitance or inductance of a component exhibits almost a flat frequency response, either a series or parallel equivalent circuit can be applied as a suitable model to express the real impedance characteristic. Practically, the simplest series and parallel models are effective in most cases when representing characteristics of general capacitor, inductor, and resistor components.

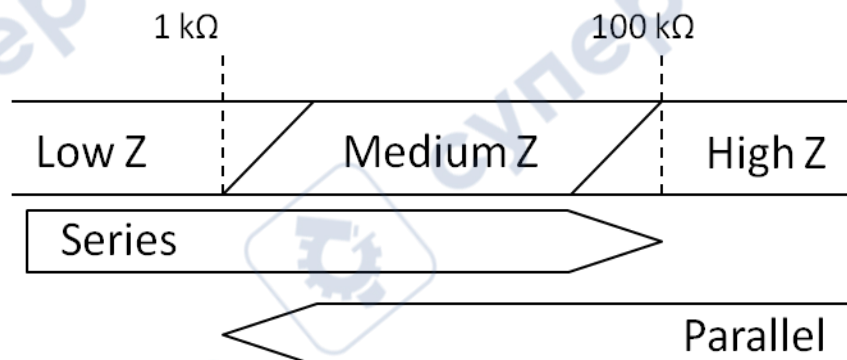

Warranty Card

What the warranty covered:

If the machine break down due to its defectiveness, MATRIX will provide free maintenance during warranty period. If the machine break down due to wrong operation or carelessness, then Matrix provide paid service within warranty period.

How long does this warranty last:

This warranty lasts for 3 years from the date of original purchase of all MATRIX branded products.

Who is covered:

This warranty covers only the original purchaser of this product. This warranty is not transferable to subsequent owners or purchasers of this product.

What do customers need to do to get repairs/service under the warranty policy?

If the machine get problem, please contact our local distributor. If you cannot find the local distributor, you can contact us directly, our email is service@szmatrix.com, our telephone No. is 0086 755 2836 4276.

What information do customers need to supply?

Model No.	
Serial No.	
Problem description	
Picture	
Video if necessary	