

MDP-P905

User Manul Of Digital Power Module

Before using this product, please read this manual

(This user's manual written based on firmware version V1.20)

table of Contents

Describes the functional	2
Operation panel interface	3
2.1 groundwork interface	3
2.2 the voltage-current adjustment setting screen (when toggle wheel)	4
2.3 browse display mode	5
2.4 Settings menu	6
2.5 Rapid setting voltage and current menu	6
2.6 Wireless address modification method	7
The method	8
Described in	9
Appendix indicator definitions updates 1	9

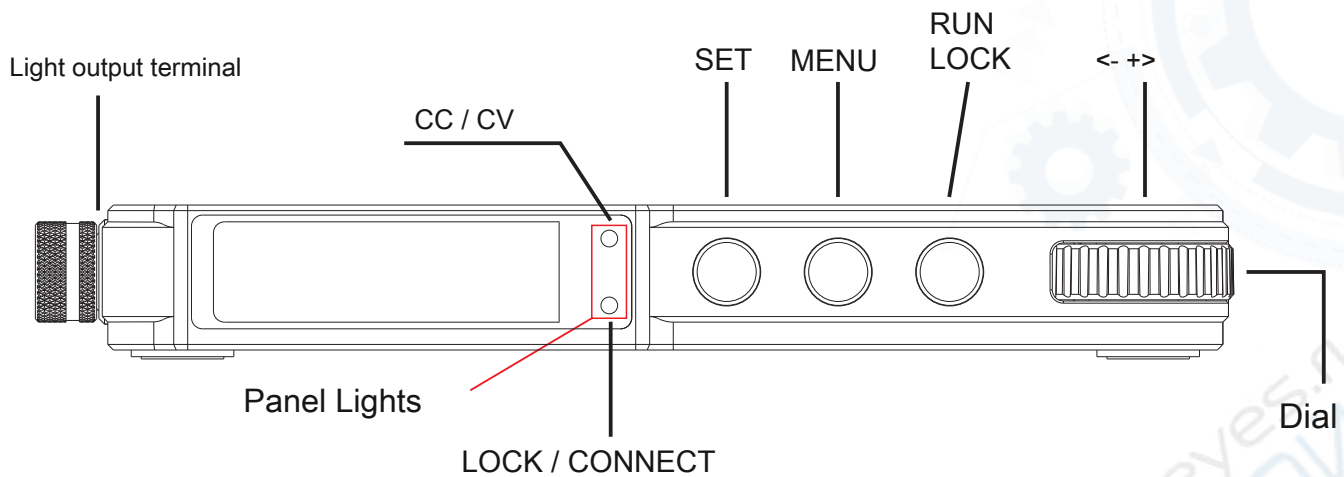

Figure 1.0

- 1) SET Set
 - The main function switching voltage and current adjustment item;
 - Press to select sub-functions;
 - coarse enable parameter is set.

- 2) MENU menu
 - Switch the display contents of the main function to check the current settings.
 - Press sub function menu setting change parameter values.

- 3) RUN / LOCK output / Lock
 - The main function output enable.
 - Deputy Press locking function parameters.

- 4) Dial
 - The main function to change the value.
 - Vice feature to jump to change the menu setting parameter values.

- 5) Priority key
 - Key RUN / LOCK high priority.
 - Keys MENU, and SET low priority roller.

- 6) Shortcuts: Press SET button and simultaneously press the MENU key is provided into the rapid voltage and current selection menu, ENCODER using preset switching cycle, the SET select a preset output interface and switching to the operating state, a timeout without selection or click Exit Exit MENU, press MENU no operation.

2.1 Foundation work Interface

RUN / LOCK:

1) output on or off operation:

Press (less than 2 seconds), the output on or off, the highest priority. Immediately determined difference between the current real-time voltage and current provided to the open current voltage if the output is turned on (refer to the Appendix 1)

2) Parameter lock and unlock methods:

Press more than 2 seconds to lock the trigger parameters, first press flipping only once. SET key lock function can not operate, voltage and current can not be provided, there is no way to display and control the remote control of the present power supply.

▲ Note: Each output is not turned on by default, you need to press once before opening.

2.1.1 Open output interface

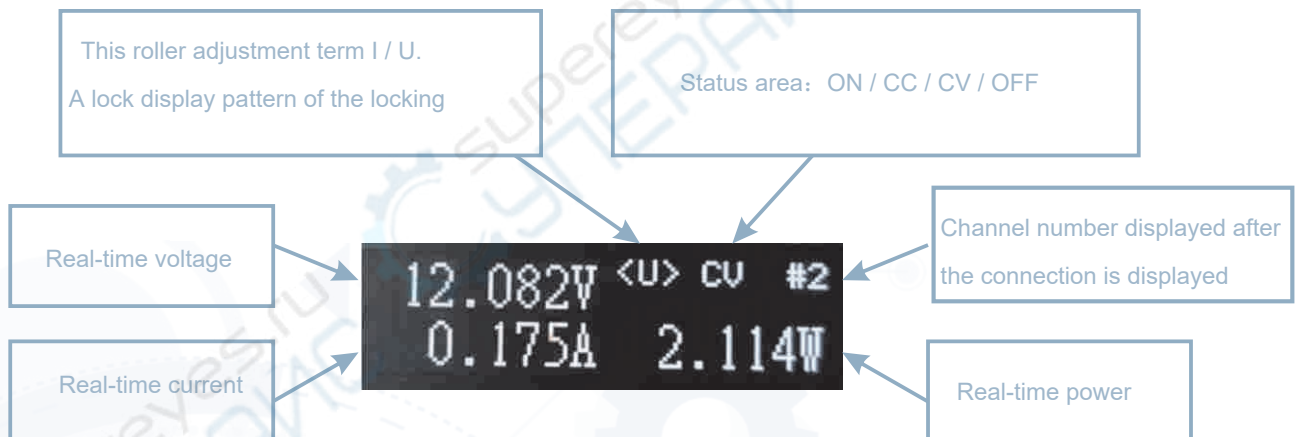

2.1.2 off the output interface

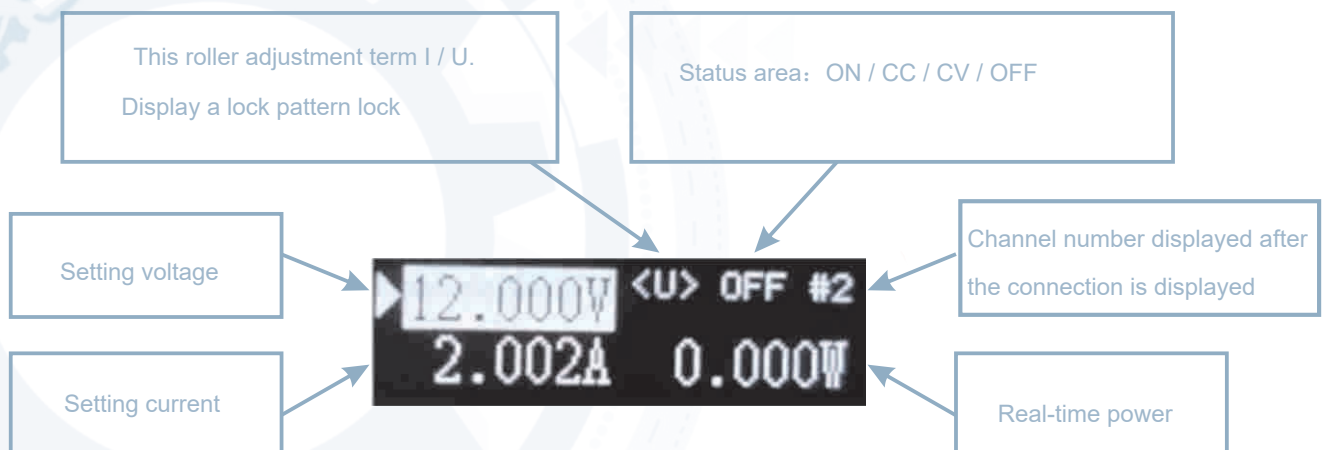

2.2 the voltage-current adjustment setting screen (when toggle wheel)

2.2.1 Select Set voltage or current Method:

In the non-LOCK state, the main interface SET key press, to modify the "current wheel adjustment item" (◀ I ▶ or ◀ U ▶).
select ◀ U ▶ Modify setting voltage value represents; choose ◀ I ▶ It represents the set current value to modify.

2.2.2 change the settings worth method:

In the non-LOCK state, normal operation when toggle wheel interface, the original display region of the power set value becomes the display region does not change the real-time voltage and current; LOCK mode change state can not enter the setting value. No operation 1 second after the wheel, the power set value back to the display.

When the setting item to the roller ◀ I ▶ Time , Toggle wheel operating current setpoint, 0.005A ~ 5.000A;

wheel is ◀ U ▶ When toggle wheel operating voltage set value, 0.01. ~ 30.000V.

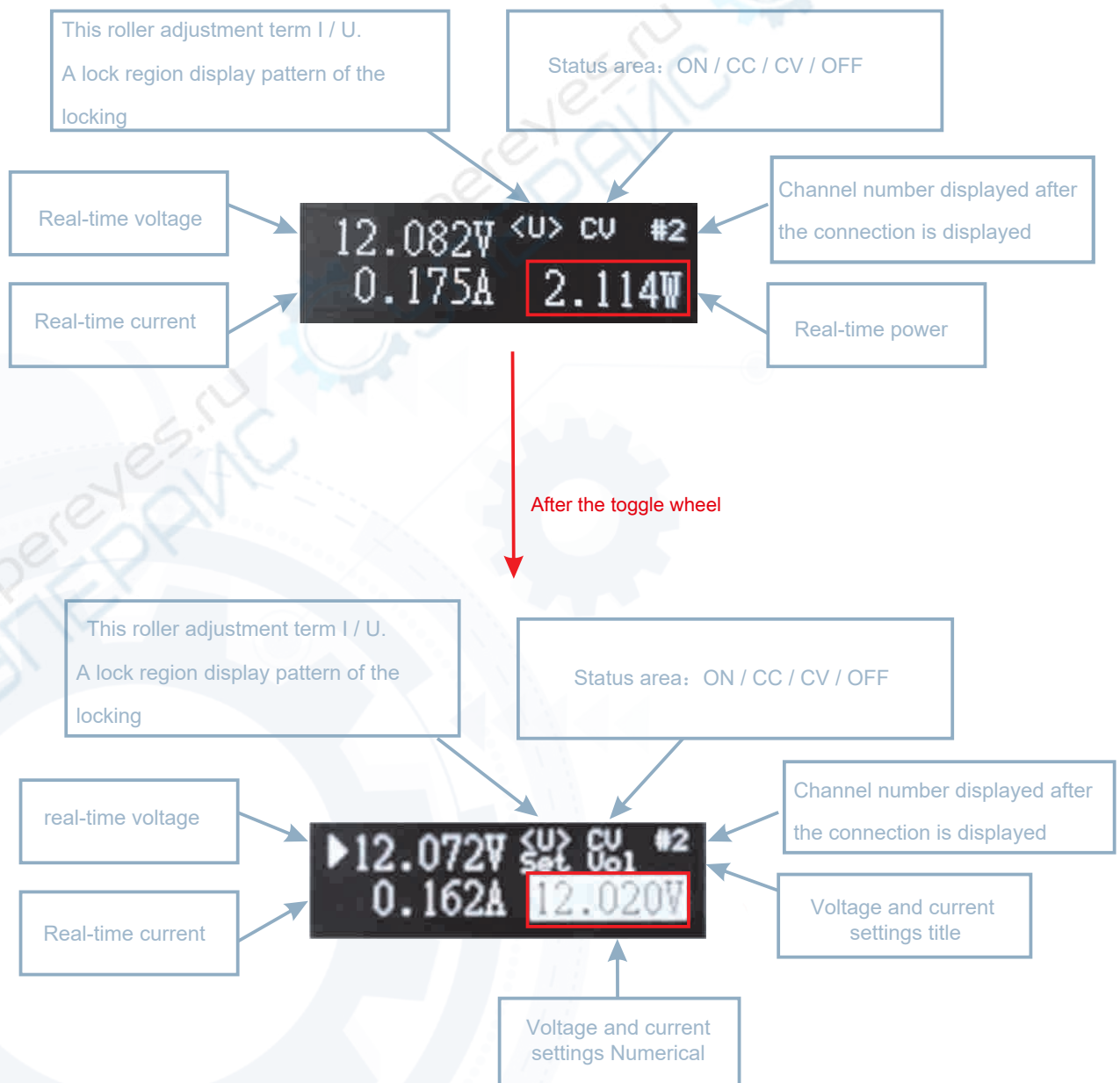

2.2.3 How coarse or fine change the values:

Coarse: Long press the SET key, while the toggle trackwheel, a coarse adjustment voltage 0.3V per step, stepping current 30mA.

Fine: when SET key is not pressed, a jog dial, when the voltage step 0.01V, current stepping 1mA.

2.2.4 The factory default setting voltage 3.000V, the default setting current 1.000A.

2.3 Browse menu display

2.3.1 Press the button DISP / MENU Enter browsing mode (Figure1.1), Press again to immediately return to the main interface;

2.3.2 Corresponds to the scroll wheel turning (without circulation), view the current status and power settings in the browser mode 5 seconds-free operation automatically returned to the main interface;

2.3.3 RUN / LOCK key operation does not affect the current display content type and category.

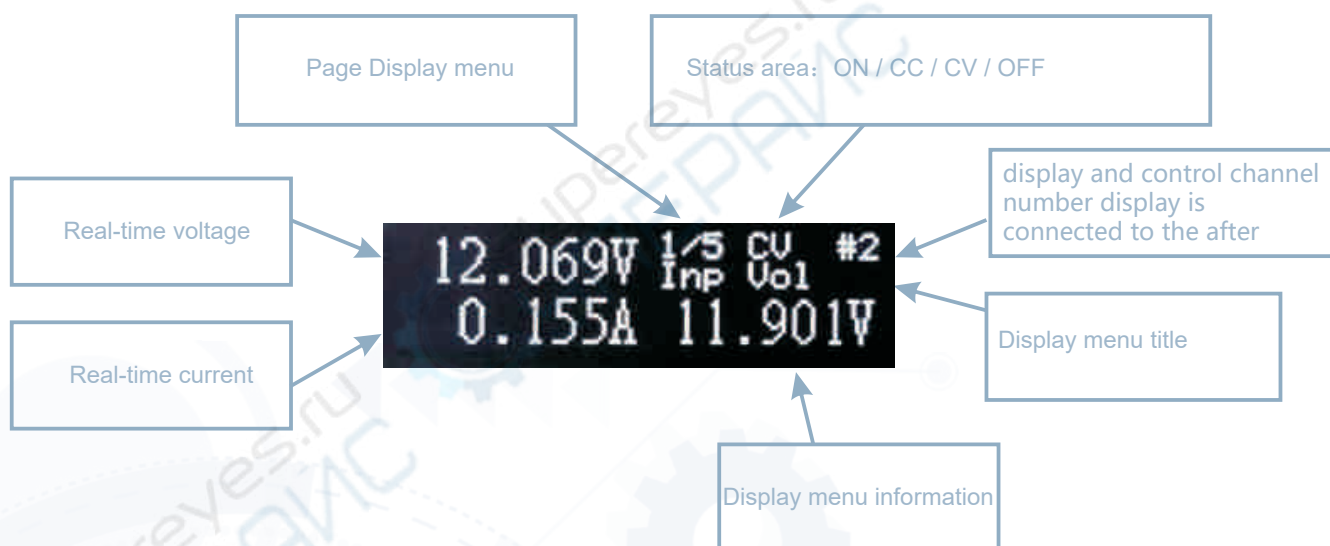

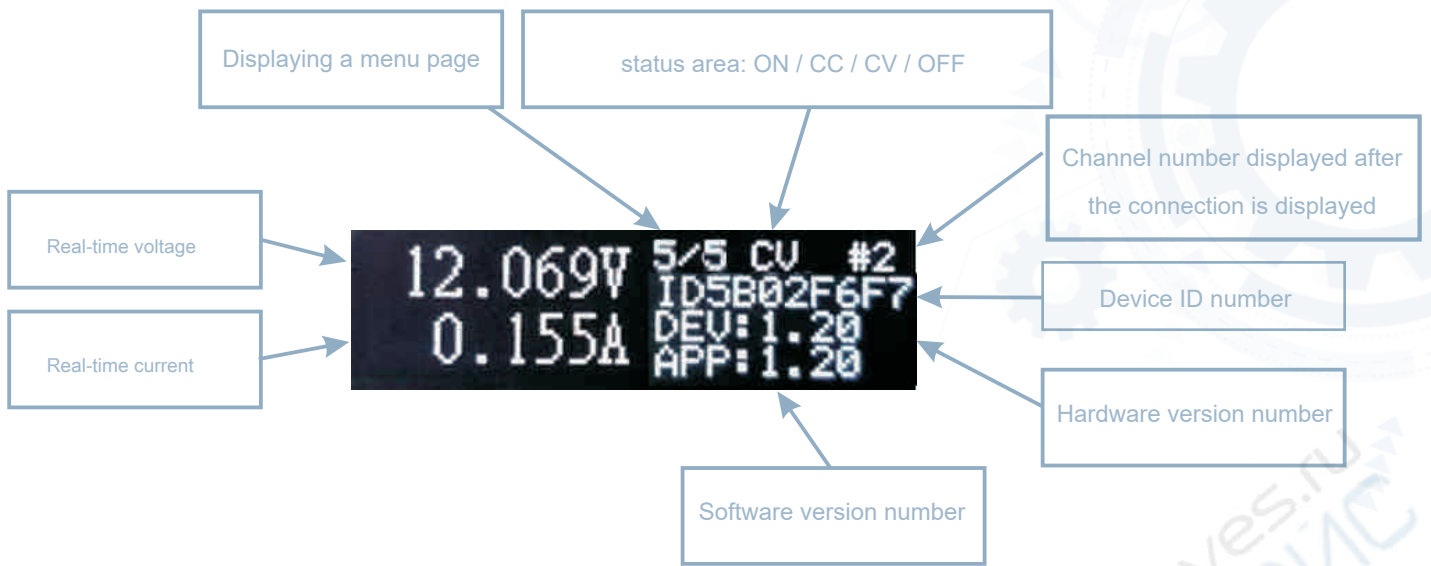

Figure 1.1

In the main interface short press DISP / MENU displays basic setting parameters:

- 1) Input voltage Inp Vol;
- 2) Input current Inp Cur;
- 3) Input current limit Inp Cur; 
- 4) Machine temperature Temp;
- 5) version information. as follows:



2.4 Setting menu

Press button DISP / MENU enter the setup menu by the SET key, to cycle solid angular position,

- ENCODER scrolling menu item pointing triangle "Menuitem";
- ENCODER to adjust the setting value triangle pointing to "Value";

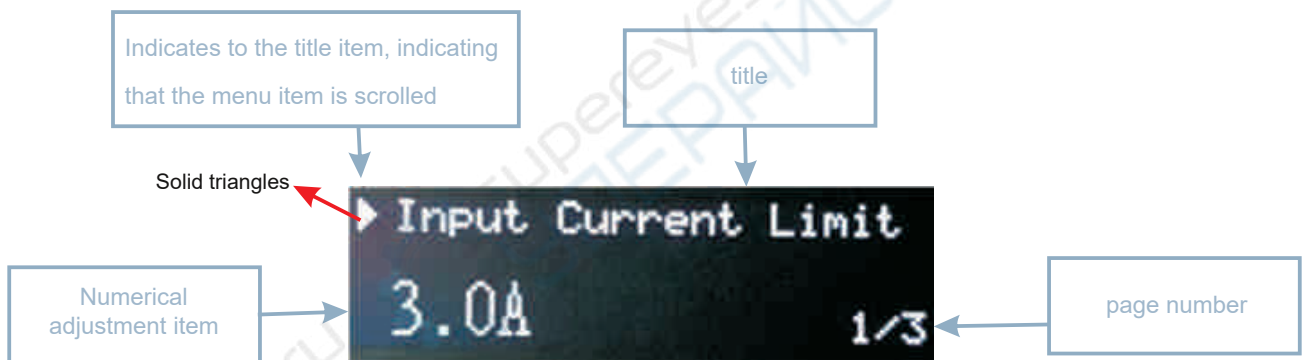

- 1) Set Menu 1: Input current limit;
- 2) Set Menu 2: Automatically match the radio address and TX RX Addr, when the wireless address match, if the power output on the basis of safety, will be forced to shut down the power supply output;
- 3) Set Menu 3: sound volume adjustment Sound Adjustet.

2.5 Rapid setting voltage and current menu

Press SET button and MENU button to enter the fast selection screen, as shown below;

- ENCODER preset value using Cycle
- SET button to select a corresponding preset values and switches the output interface to the operating state without selection
- or click MENU Exit Exit timeout, no operation press MENU



▲ The default value can be modified by Q_SET.TXT documents, the contents of the file as shown below, changes take effect after the restart.

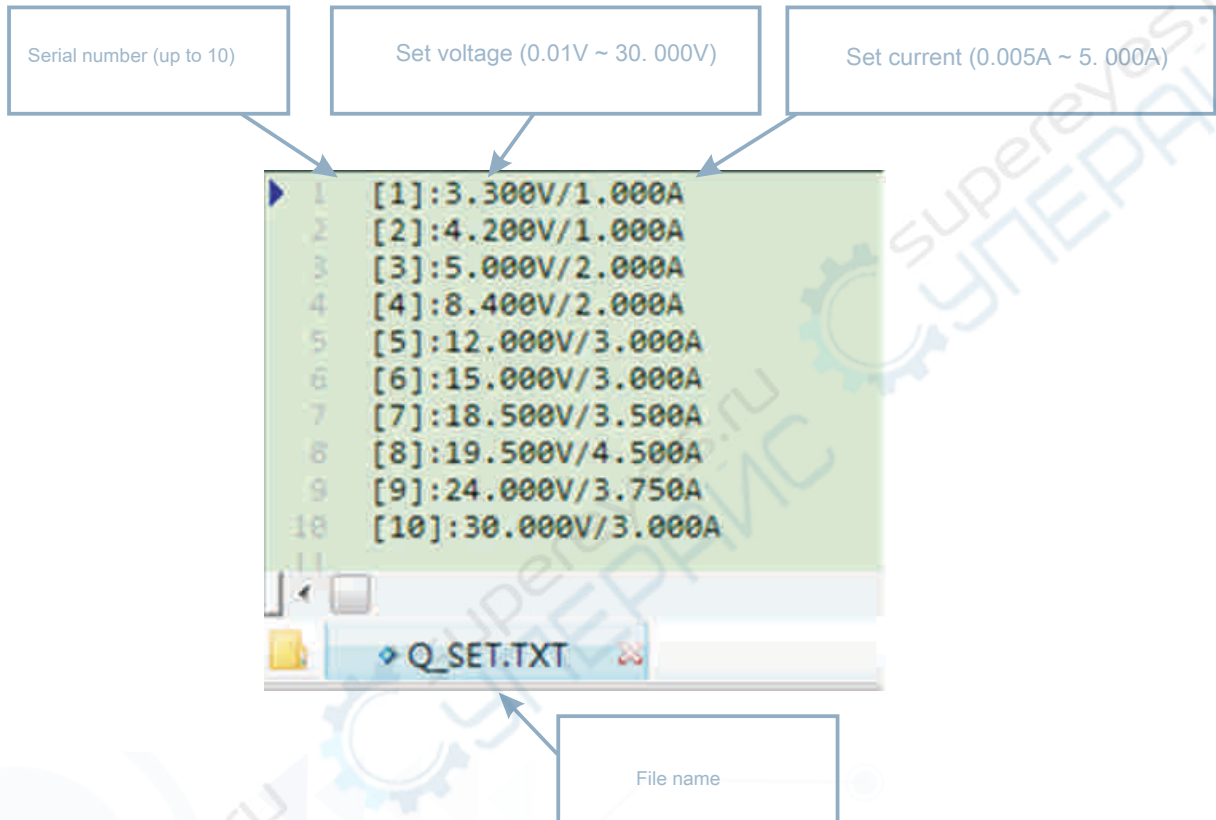

2.6 Wireless address modification method

Power can enter the U disk to modify wireless radio frequency with the address of the file to match the display and control, the document called RX_ADDR.TXT, the contents of the file as shown below, changes will take effect after reboot.

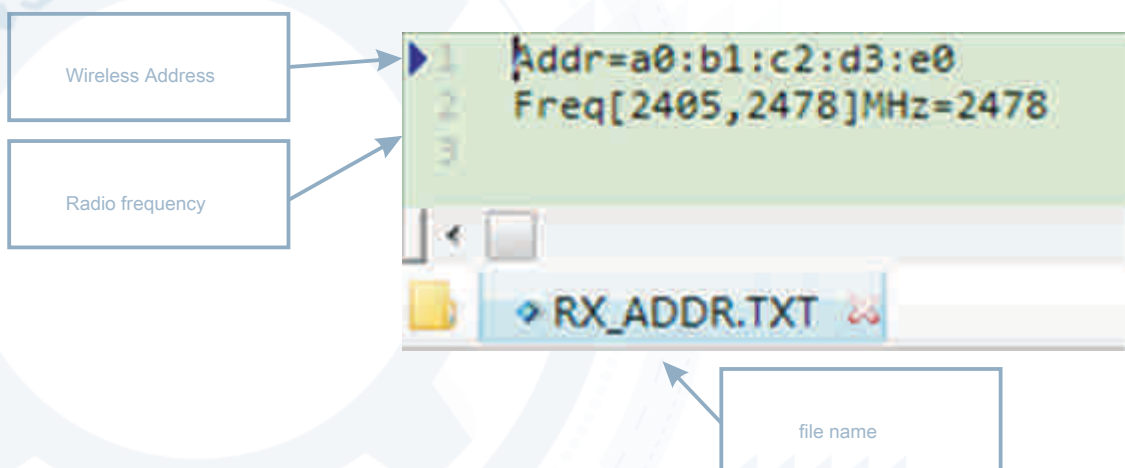

A: lamp output terminal (for details see FIG. 1):

Normal full light output, it turns off when the output is off, the output off after 1 minute, go to sleep output off after six minutes, Quammie off.

B: panel lights (for details see FIG. 1):

- 1) When the output is off, the blue light in the upper respiratory state;
- 2) an output, the constant-voltage-red light when in the state, when a constant current upper full bright light blue;
- 3) when the locking force, the lower side of the red light;
- 4) when the alarm (including input overvoltage, overheating, power supply fails, the output to reach its own alarm condition)Red light flashes up and down at the same time.

Light-bit	State	Meaning
Light output terminal	Bright flame	Turn on the output
	Often off	Turn off the output
	Always put out	Standby, screen off
Red light 1	Bright flame	Turn on the output, state of the constant voltage CC
	Always off	Turn off the output
Blue lights 2	Bright flame	Turn on the output, constant current CV state
	Always put out	Turn off the output
Red light 2	Bright flame	Parameter lock
	Always put out	Parameter not locked
Green light 1	Bright flame	not disconnected
	sparkle	Select the extension has been disconnected
	Turn off the flash	has been disconnected
Up and down the red	sparkle	alarm

Press the power button of the SET, while usb connected to the computer with the USB cable, the computer name will appear: DFU

Vx_xx_x removable hard disk, the Prepared .hex firmware copied to the root directory of the mobile disk, the firmware when the extension becomes .rdy .hex, power restart, the firmware is completed upgrade.

Appendix 1 Description

Note that (abnormalities alarm description):

1. If the interface displays "Factory Fail", the default parameter file read exception.
2. If the interface displays "Param Error", the power anomaly reads the parameter file.
3. If the interface displays "Quick Setting Error", the rapid voltage and current provided abnormal parameter files.
4. The input current exceeds the set current value of + 20% of the alarm, the interface displays "INPUT ELEC ERROR", buzzer, double red flash.
5. The input voltage is lower than 3V alarm, display interface "INPUT VOLT ERROR", buzzer, double flash red.
6. When the device temperature is less than 0 degrees, greater than 70 degrees, it will shut down.
7. When the screen displays "Flash Error", flash chips exception.
8. When the screen displays "Wireless Error", the wireless chip exception.