

SDS2000X Plus Series Digital Oscilloscope

User Manual

EN01D



Contents

1	INTRODUCTION	9
2	GENERAL SAFETY SUMMARY	10
2.1	SAFETY TERMS AND SYMBOLS	10
2.2	WORKING ENVIRONMENT	11
2.3	COOLING REQUIREMENTS	13
2.4	AC POWER	13
2.5	POWER AND GROUND CONNECTIONS	14
2.6	CALIBRATION	15
2.7	CLEANING	15
2.8	ABNORMAL CONDITIONS	16
	EXIGENCE DE SECURITE	17
	TERMES ET SYMBOLES DE SÉCURITÉ	17
	ENVIRONNEMENT DE TRAVAIL	18
	EXIGENCES DE REFOUILLISSEMENT	20
	AC POWER	20
	CONNEXIONS D'ALIMENTATION ET DE TERRE	21
	ÉTALONNAGE	22
	NETTOYAGE	22
	CONDITIONS ANORMALES	23
3	FIRST STEPS	24
3.1	DELIVERY CHECKLIST	24
3.2	QUALITY ASSURANCE	24
3.3	MAINTENANCE AGREEMENT	25
4	DOCUMENT CONVENTIONS	26
5	GETTING STARTED	27
5.1	POWER ON	27
5.2	SHUT DOWN	27
5.3	SYSTEM STATUS	28
5.4	INSTALL OPTIONS	28
6	PROBE	29
6.1	PROBE SAFETY	29
6.2	PROBE COMPENSATION	30
7	QUICK START	31
7.1	FRONT PANEL OVERVIEW	31
7.2	REAR PANEL OVERVIEW	33
7.3	CONNECTING TO EXTERNAL DEVICES/SYSTEMS	34
7.3.1	Power Supply	34

7.3.2	LAN.....	34
7.3.3	USB Peripherals.....	34
7.3.4	Auxiliary Output.....	34
7.3.5	Probes.....	35
7.3.6	Logic Probe.....	35
8	TOUCH SCREEN DISPLAY	36
8.1	OVERVIEW	36
8.2	MENU BAR.....	38
8.3	GRID AREA	39
8.4	CHANNEL DESCRIPTOR BOX.....	40
8.5	TIMEBASE AND TRIGGER DESCRIPTOR BOXES.....	42
8.6	DIALOG BOX.....	45
8.7	TOUCH GESTURES	48
8.8	MOUSE AND KEYBOARD OPERATION	50
8.9	CHOOSING THE LANGUAGE.....	50
9	FRONT PANEL.....	51
9.1	OVERVIEW	51
9.2	VERTICAL CONTROL.....	52
9.3	HORIZONTAL CONTROL.....	53
9.4	TRIGGER CONTROL	54
9.5	RUN/STOP BUTTON.....	54
9.6	AUTO SETUP BUTTON	55
9.7	COMMON FUNCTION	55
9.8	CURSORS CONTROL	56
9.9	UNIVERSAL KNOB	56
9.10	OTHER BUTTONS.....	57
10	MULTIPLE APPROACHES TO RECALL FUNCTIONS	58
10.1	MENU BAR.....	58
10.2	DESCRIPTOR BOX	58
10.3	SHORTCUT BUTTON ON THE FRONT PANEL	59
11	QUICKLY CAPTURE THE SIGNAL.....	60
12	VERTICAL SETUP	61
12.1	TURN ON/OFF A CHANNEL	61
12.2	CHANNEL SETUP.....	62
13	DIGITAL CHANNELS.....	68
13.1	OVERVIEW	68
13.2	ENABLE/DISABLE THE DIGITAL CHANNELS	70
13.3	DIGITAL CHANNEL SETUP	72
14	HORIZONTAL AND ACQUISITION SETUP	75

14.1	TIMEBASE SETUP	75
14.2	ACQUISITION SETUP	76
14.2.1	Overview.....	76
14.2.2	Acquisition.....	79
14.2.3	Roll Mode	81
14.2.4	Sequence.....	81
14.3	HISTORY	85
14.4	ZOOM.....	88
15	TRIGGER.....	90
15.1	OVERVIEW	90
15.2	TRIGGER SETUP.....	92
15.3	TRIGGER LEVEL.....	94
15.4	TRIGGER MODE	94
15.5	TRIGGER TYPE	95
15.5.1	Overview.....	95
15.5.2	Edge Trigger.....	96
15.5.3	Slope Trigger.....	97
15.5.4	Pulse Trigger.....	100
15.5.5	Video Trigger.....	101
15.5.6	Window Trigger.....	106
15.5.7	Interval Trigger.....	109
15.5.8	Dropout Trigger.....	109
15.5.9	Runt Trigger.....	110
15.5.10	Pattern Trigger.....	111
15.6	TRIGGER SOURCE	114
15.7	HOLDOFF	115
15.8	TRIGGER COUPLING.....	117
15.9	NOISE REJECT	117
15.10	ZONE TRIGGER.....	118
16	SERIAL TRIGGER AND DECODE	125
16.1	OVERVIEW	125
16.2	I2C TRIGGER AND SERIAL DECODE.....	128
16.2.1	I2C Signal Settings	128
16.2.2	I2C Trigger.....	129
16.2.3	I2C Serial Decode.....	134
16.3	SPI TRIGGER AND SERIAL DECODE.....	137
16.3.1	SPI Signal Settings	137
16.3.2	SPI Trigger.....	141
16.3.3	SPI Serial Decode.....	141
16.4	UART TRIGGER AND SERIAL DECODE	142
16.4.1	UART Signal Settings.....	142
16.4.2	UART Trigger.....	143

16.4.3	<i>UART Serial Decode</i>	145
16.5	CAN TRIGGER AND SERIAL DECODE	146
16.5.1	<i>CAN Signal Settings</i>	146
16.5.2	<i>CAN Trigger</i>	147
16.5.3	<i>CAN Serial Decode</i>	147
16.6	LIN TRIGGER AND SERIAL DECODE	150
16.6.1	<i>LIN Signal Settings</i>	150
16.6.2	<i>LIN Trigger</i>	150
16.6.3	<i>LIN Serial Decode</i>	151
16.7	FLEXRAY TRIGGER AND SERIAL DECODE.....	153
16.7.1	<i>FlexRay Signal Settings</i>	153
16.7.2	<i>FlexRay Trigger</i>	153
16.7.3	<i>FlexRay Serial Decode</i>	154
16.8	CAN FD TRIGGER AND SERIAL DECODE	157
16.8.1	<i>CAN FD Signal Settings</i>	157
16.8.2	<i>CAN FD Trigger</i>	157
16.8.3	<i>CAN FD Serial Decode</i>	159
16.9	I2S TRIGGER AND SERIAL DECODE	161
16.9.1	<i>I2S Signal Settings</i>	161
16.9.2	<i>I2S Trigger</i>	162
16.9.3	<i>I2S Serial Decode</i>	164
16.10	MIL-STD-1553B TRIGGER AND SERIAL DECODE	165
16.10.1	<i>MIL-STD-1553B Signal Settings</i>	165
16.10.2	<i>MIL-STD-1553B Serial Decode</i>	165
16.11	SENT TRIGGER AND SERIAL DECODE	167
16.11.1	<i>SENT Signal Settings</i>	167
16.11.2	<i>SENT Trigger</i>	168
16.11.3	<i>SENT Serial Decode</i>	172
16.12	MANCHESTER SERIAL DECODE	175
16.12.1	<i>Manchester Signal Settings</i>	175
16.12.2	<i>Manchester Serial Decode</i>	177
17	CURSORS	178
17.1	OVERVIEW	178
17.2	SELECT AND MOVE CURSORS	185
18	MEASUREMENT	188
18.1	OVERVIEW	188
18.2	SET PARAMETERS	190
18.3	TYPE OF MEASUREMENT	194
18.3.1	<i>Vertical Measurement</i>	194
18.3.2	<i>Horizontal Measurement</i>	196
18.3.3	<i>Miscellaneous Measurements</i>	198
18.3.4	<i>Delay Measurement</i>	199

18.4	TREND	201
18.5	DISPLAY MODE	202
18.6	MEASUREMENT STATISTICS	203
18.7	STATISTICS HISTOGRAM	205
18.8	SIMPLE MEASUREMENTS	206
18.9	GATE.....	206
18.10	AMPLITUDE STRATEGY.....	208
18.11	THRESHOLD.....	209
19	MATH	211
19.1	OVERVIEW	211
19.2	ARITHMETIC	213
19.2.1	<i>Average</i>	214
19.2.2	<i>ERES</i>	215
19.3	ALGEBRA	217
19.3.1	<i>Differential</i>	217
19.3.2	<i>Integral</i>	218
19.3.3	<i>Square Root</i>	219
19.3.4	<i>Absolute</i>	220
19.3.5	<i>Sign</i>	220
19.3.6	<i>Exp/Exp10</i>	221
19.3.7	<i>Ln/Lg</i>	222
19.3.8	<i>Interpolate</i>	223
19.4	FREQUENCY ANALYSIS.....	224
19.5	FORMULA EDITOR	235
20	REFERENCE.....	237
21	SEARCH.....	239
22	NAVIGATE.....	242
23	MASK TEST.....	249
23.1	OVERVIEW	249
23.2	MASK SETUP	251
23.2.1	<i>Create Mask</i>	251
23.2.2	<i>Mask Editor</i>	253
23.3	PASS/FAIL RULE.....	255
23.4	OPERATION.....	256
24	COUNTER	257
24.1	OVERVIEW	257
24.2	MODE.....	258
25	POWER ANALYSIS	261
25.1	OVERVIEW	261
25.2	POWER QUALITY.....	262

25.3	CURRENT HARMONICS	264
25.4	INRUSH CURRENT	266
25.5	SWITCHING LOSS	268
25.6	SLEW RATE	273
25.7	MODULATION	274
25.8	OUTPUT RIPPLE.....	275
25.9	TURN ON/TURN OFF	275
25.10	TRANSIENT RESPONSE.....	278
25.11	PSRR	281
25.12	POWER EFFICIENCY.....	282
26	BODE PLOT.....	283
26.1	OVERVIEW	283
26.2	CONFIGURATION	284
26.2.1	<i>Connection.....</i>	284
26.2.2	<i>Sweep</i>	285
26.3	DISPLAY	287
26.4	DATA ANALYSIS.....	290
27	DISPLAY	294
28	ARBITRARY WAVEFORM GENERATOR	303
28.1	OVERVIEW	303
28.2	OUTPUT	304
28.3	WAVE TYPE	304
28.4	OTHER SETTING.....	306
29	SAVE/RECALL	308
29.1	SAVE TYPE	308
29.2	INTERNAL SAVE AND RECALL	312
29.3	EXTERNAL SAVE AND RECALL	314
29.3.1	<i>File manager.....</i>	314
29.3.2	<i>External Save and Recall Instance</i>	317
30	SYSTEM SETTING	320
30.1	SYSTEM STATUS.....	320
30.2	SOUND	321
30.3	UPGRADE SOFTWARE.....	321
30.4	LANGUAGE	323
30.5	SCREEN SAVER	323
30.6	I/O SETTING.....	324
30.6.1	<i>LAN.....</i>	324
30.6.2	<i>Web Server.....</i>	325
30.7	DATE/TIME.....	325
30.8	INSTALL OPTIONS	326
30.9	REFERENCE POSITION SETTING	328

30.10	PERFORM SELF-TEST	331
30.11	DO SELF CAL	334
30.12	POWER ON LINE.....	335
30.13	DEBUG	335
31	REMOTE CONTROL	336
31.1	WEB BROWSER	336
31.2	OTHER CONNECTIVITY.....	338
32	TROUBLESHOOTING	339

1 Introduction

This user manual includes important safety and installation information related to the SDS2000X Plus series oscilloscopes and includes simple tutorials for basic operation of the oscilloscope.

The series includes the following models:







Model	Analog Bandwidth
SDS2354X Plus	350 MHz bandwidth, 4-channel, 2 GSa/s Sample rate
SDS2204X Plus	200 MHz bandwidth, 4-channel, 2 GSa/s Sample rate
SDS2104X Plus	100 MHz bandwidth, 4-channel, 2 GSa/s Sample rate
SDS2102X Plus	100 MHz bandwidth, 2-channel, 2 GSa/s Sample rate

2 General Safety Summary

This chapter contains information and warnings that must be followed to keep the instrument operating under the appropriate safety conditions. In addition to the safety precautions specified in this section, you must also follow recognized safety procedures.

2.1 Safety Terms and Symbols

When the following symbols or terms appear on the front or rear panel of the instrument or in this manual, they indicate special care in terms of safety.

	This symbol is used where caution is required. Refer to the accompanying information or documents in order to protect against personal injury or damage to the instrument.
	This symbol warns of a potential risk of shock hazard.
	This symbol is used to denote the measurement ground connection.
	This symbol is used to denote a safety ground connection.
	This symbol shows that the switch is an On/Standby switch. When it is pressed, the scope's state switches between Operation and Standby. This switch does not disconnect the device's power supply. To completely power off the scope, the power cord must be unplugged from the AC socket after the oscilloscope is in the standby state.
	This symbol is used to represent an alternating current, or "AC".
CAUTION	The "CAUTION" symbol indicates a potential hazard. It calls attention to a procedure, practice or condition which may be dangerous if not followed. Do not proceed until its conditions are fully understood and met.

WARNING	The "WARNING" symbol indicates a potential hazard. It calls attention to a procedure, practice or condition which, if not followed, could possibly cause bodily injury or death. If a WARNING is indicated, do not proceed until the safety conditions are fully understood and met.
---------	--

2.2 Working Environment

This instrument is intended for indoor use and should be operated in a clean, dry environment with an ambient temperature range of 0 °C – 40 °C.

Temperature

Operating: 0 °C to +40 °C

Non-operation: -20 °C to +60 °C

Humidity

Operating: 85% RH, 40 °C, 24 hours

Non-operating: 85% RH, 65 °C, 24 hours

Altitude

Operating: \leq 3,000 m

Non-operating: \leq 15,266 m

Note: Direct sunlight, radiators, and other heat sources should be taken into account when assessing the ambient temperature.



WARNING: Do not operate the oscilloscope in an explosive atmosphere or wet and damp conditions.

The design of the instrument has been verified to conform to EN 61010-1 safety standard per the following limits:

- Installation (overvoltage) Category: II (Mains Supply Connector)
- Degree of Pollution: II
- Degree of Protection: IP20

Note:

Installation (Overvoltage) Category II refers to the local distribution level, which is applicable to equipment connected to the mains supply (AC power source).

Degree of Pollution II refers to a working environment which is dry and non-conductive pollution occurs. Occasional temporary conductivity caused by condensation is expected.



CAUTION: Protect the display touch screen of the scope from excessive impact.



CAUTION: Do not exceed the maximum specified front panel terminal (CH1, CH2, CH3, CH4, EXT) voltage levels. Refer to Specifications for more details.



CAUTION: Do not connect or disconnect probes or test leads while they are connected to a voltage source.

2.3 Cooling Requirements

This instrument relies on forced air cooling with internal fans and ventilation openings. Care must be taken to avoid restricting the airflow around the apertures (fan holes) at each side of the scope. To ensure adequate ventilation it is required to leave a 15 cm (6 inch) minimum gap around the sides of the instrument.

	CAUTION: Do not block the ventilation holes located on both sides of the scope.
---	--

	CAUTION: Do not allow any foreign matter to enter the scope through the ventilation holes, etc.
---	--

2.4 AC Power

The instrument operates with a single-phase, 100 to 240 Vrms (+/-10%) AC power at 50/60 Hz (+/-5%), or single-phase 100 - 120 Vrms (+/-10%) AC power at 400Hz (+/-5%).

No manual voltage selection is required because the instrument automatically adapts to line voltage.

Depending on the type and number of options and accessories (probes, PC port plug-in, etc.), the instrument can consume up to 100 W of

power.

Note: The instrument automatically adapts to the AC line input within the following ranges:

Voltage Range:	90 - 264 Vrms	90 - 132 Vrms
Frequency Range:	47 - 63 Hz	380 - 420 Hz

2.5 Power and ground connections

The instrument includes a grounded cord set containing a molded three-terminal polarized plug and a standard IEC320 (Type C13) connector for making line voltage and safety ground connection. The AC inlet ground terminal is connected directly to the frame of the instrument. For adequate protection against electrical shock hazard, the power cord plug must be inserted into a mating AC outlet containing a safety ground contact. Use only the power cord specified for this instrument and certified for the country of use.

	<p>Warning: Electrical Shock Hazard!</p> <p>Any interruption of the protective ground conductor within or outside of the scope or disconnection of the safety ground terminal creates a hazardous situation.</p> <p>Intentional interruption is prohibited.</p>
---	--

The position of the oscilloscope should allow easy access to the socket. To make the oscilloscope completely power off, unplug the instrument power cord from the AC socket.

The power cord should be unplugged from the AC outlet if the scope is not to be used for an extended period of time.



CAUTION: The outer shells of the front panel terminals (CH1, CH2, CH3, CH4, EXT) are connected to the instrument's chassis and therefore to the safety ground.

2.6 Calibration

The recommended calibration interval is one year. Calibration should be only performed by qualified personnel.

2.7 Cleaning

Clean only the exterior of the instrument, using a damp, soft cloth. Do not use chemicals or abrasive elements. Under no circumstances allow moisture to penetrate the instrument. To avoid electrical shock, unplug the power cord from the AC outlet before cleaning.



Warning: Electrical Shock Hazard!

No operator serviceable parts inside. Do not remove covers.
Refer servicing to qualified personnel

2.8 Abnormal Conditions

Only operate the instrument for the purposes specified by the manufacturer.

Do not operate the scope if there are any visible signs of damage or if it has been subjected to severe transport stresses.

If you suspect the scope's protection has been impaired, disconnect the power cord and secure the instrument against any unintended operation.

Proper use of the instrument requires reading and understanding all of the instructions and labels.









Warning: Any use of the scope in a manner not specified by the manufacturer may impair the instrument's safety protection. This instrument should not be directly connected to human subjects or used for patient monitoring.

Exigence de Sécurité

Ce chapitre contient des informations et des avertissements qui doivent être suivis pour maintenir l'instrument en fonctionnement dans les conditions de sécurité appropriées. En plus des précautions de sécurité spécifiées dans cette section, vous devez également suivre les procédures de sécurité reconnues.

Termes et symboles de sécurité

Lorsque les symboles ou termes suivants apparaissent sur le panneau avant ou arrière de l'instrument ou dans ce manuel, ils indiquent un soin particulier en termes de sécurité.

	Ce symbole est utilisé lorsque la prudence est requise. Reportez-vous aux informations ou documents joints afin de vous protéger contre les blessures ou les dommages à l'instrument.
	Ce symbole avertit d'un risque potentiel de choc électrique.
	Ce symbole est utilisé pour désigner la connexion de terre de mesure.
	Ce symbole est utilisé pour indiquer une connexion à la terre de sécurité.
	Ce symbole indique que l'interrupteur est un interrupteur marche / veille. Lorsqu'il est enfoncé, l'état de l'oscilloscope bascule entre Fonctionnement et Veille. Ce commutateur ne déconnecte pas l'alimentation de l'appareil. Pour éteindre complètement l'oscilloscope, le cordon d'alimentation doit être débranché de la prise secteur une fois l'oscilloscope en état de veille.
	Ce symbole est utilisé pour représenter un courant alternatif, ou "AC".
CAUTION	Le symbole " CAUTION " indique un danger potentiel. Il attire l'attention sur une procédure, une pratique ou une condition qui peut être dangereuse si elle n'est pas suivie. Ne

	continuez pas tant que ses conditions n'ont pas été entièrement comprises et remplies.
WARNING	Le symbole " WARNING " indique un danger potentiel. Il attire l'attention sur une procédure, une pratique ou une condition qui, si elle n'est pas suivie, pourrait entraîner des blessures corporelles ou la mort. Si un AVERTISSEMENT est indiqué, ne continuez pas tant que les conditions de sécurité ne sont pas entièrement comprises et remplies.

Environnement de travail

Cet instrument est destiné à une utilisation en intérieur et doit être utilisé dans un environnement propre et sec avec une plage de température ambiante de 0 ° C à 40 ° C.

Température

En fonctionnement: 0 °C à +40 °C

Hors fonctionnement: -20 °C à +60 °C

Humidité

Fonctionnement: 85% HR, 40 °C, 24 heures

Hors fonctionnement: 85% HR, 65 °C, 24 heures

Altitude

Fonctionnement: \leq 3000m

À l'arrêt: \leq 15 266 m

Remarque: La lumière directe du soleil, les radiateurs et autres sources de chaleur doivent être pris en compte lors de l'évaluation

de la température ambiante.

	AVERTISSEMENT: n'utilisez pas l'oscilloscope dans une atmosphère explosive ou dans des conditions humides et humides.
---	--

La conception de l'instrument a été vérifiée pour être conforme à la norme de sécurité EN 61010-1 selon les limites suivantes:

- Catégorie d'installation (surtension): II (connecteur d'alimentation secteur)
- Degré de pollution: II
- Degré de protection: IP20

Remarque:

La catégorie II d'installation (surtension) fait référence au niveau de distribution local, qui s'applique aux équipements connectés au secteur (source d'alimentation CA).

Degré de pollution II fait référence à un environnement de travail sec et une pollution non conductrice se produit. Une conductivité temporaire occasionnelle causée par la condensation est attendue.

	ATTENTION: Protégez l'écran tactile de la lunette de tout impact excessif.
---	---

	ATTENTION: Ne dépassez pas les niveaux de tension maximum spécifiés aux bornes du panneau avant (CH1, CH2, CH3, CH4, EXT). Reportez-vous aux Spécifications pour plus de détails.
---	--

	ATTENTION: Ne connectez ou déconnectez pas les sondes ou les cordons de test lorsqu'ils sont connectés à une source de tension.
---	--

Exigences de refroidissement

Cet instrument repose sur un refroidissement à air forcé avec des ventilateurs internes et des ouvertures de ventilation. Des précautions doivent être prises pour éviter de restreindre le flux d'air autour des ouvertures (trous de ventilateur) de chaque côté de la lunette. Pour assurer une ventilation adéquate, il est nécessaire de laisser un espace minimum de 15 cm (6 pouces) sur les côtés de l'instrument.

	ATTENTION: Ne bloquez pas les trous de ventilation situés des deux côtés de la lunette.
---	--

	ATTENTION: Ne laissez aucun corps étranger pénétrer dans la lunette par les trous de ventilation, etc.
---	---

AC Power

L'instrument fonctionne avec une alimentation CA monophasée de 100 à 240 Vrms (+/- 10%) à 50/60 Hz (+/- 5%) ou monophasée 100-120 Vrms (+/- 10%) Alimentation AC à 400 Hz (+/- 5%).

Aucune sélection manuelle de la tension n'est requise car l'instrument s'adapte automatiquement à la tension de ligne.

Selon le type et le nombre d'options et d'accessoires (sondes, plug-in de port PC, etc.), l'instrument peut consommer jusqu'à 100 W d'énergie.

Remarque: l'instrument s'adapte automatiquement à l'entrée de ligne CA dans les plages suivantes:

Plage de tension:	90 - 264 Vrms	90 - 132 Vrms
Gamme de fréquences:	47 - 63 Hz	380 - 420 Hz

Connexions d'alimentation et de terre

L'instrument comprend un jeu de cordons mis à la terre contenant une fiche polarisée à trois bornes moulée et un connecteur standard IEC320 (Type C13) pour établir la tension de ligne et la connexion de mise à la terre de sécurité. La borne de mise à la terre de l'entrée CA est directement connectée au châssis de l'instrument. Pour une protection adéquate contre les risques d'électrocution, la fiche du cordon d'alimentation doit être insérée dans une prise secteur correspondante contenant un contact de sécurité avec la terre. Utilisez uniquement le cordon d'alimentation spécifié pour cet instrument et certifié pour le

pays d'utilisation.

	<p>Avvertimento: rischio di shock elettrico!</p> <p>Tutte interruzioni del conduttore di terra di protezione all'interno o all'esterno della portata o la disconnessione della presa di terra di sicurezza crea una situazione pericolosa.</p> <p>L'interruzione intenzionale è vietata.</p>
---	---

La posizione dell'oscilloscopio deve permettere un accesso facile alla presa. Per spegnere completamente l'oscilloscopio, scollegate il cavo di alimentazione dell'strumento dalla presa a muro.

Il cavo di alimentazione deve essere scollegato dalla presa a muro se la lenti non deve essere utilizzata per un periodo prolungato.

	<p>ATTENTION: les enveloppes extérieures des bornes du panneau avant (CH1, CH2, CH3, CH4, EXT) sont connectées au châssis de l'instrument et donc à la terre de sécurité.</p>
---	--

Étalonnage

L'intervalle d'étalonnage recommandé est d'un an. L'étalonnage ne doit être effectué que par du personnel qualifié.

Nettoyage

Nettoyez uniquement l'extérieur de l'instrument à l'aide d'un chiffon

doux et humide. N'utilisez pas de produits chimiques ou d'éléments abrasifs. Ne laissez en aucun cas l'humidité pénétrer dans l'instrument. Pour éviter les chocs électriques, débranchez le cordon d'alimentation de la prise secteur avant de le nettoyer.

	<p>Avertissement: risque de choc électrique!</p> <p>Aucune pièce réparable par l'opérateur à l'intérieur. Ne retirez pas les capots.</p> <p>Confiez l'entretien à un personnel qualifié</p>
---	--

Conditions anormales

Utilisez l'instrument uniquement aux fins spécifiées par le fabricant.

N'utilisez pas la lunette s'il y a des signes visibles de dommages ou si elle a été soumise à de fortes contraintes de transport.

Si vous pensez que la protection de l'oscilloscope a été altérée, débranchez le cordon d'alimentation et sécurisez l'instrument contre toute opération involontaire.

Une bonne utilisation de l'instrument nécessite la lecture et la compréhension de toutes les instructions et étiquettes.

	<p>Avertissement: Toute utilisation de l'oscilloscope d'une manière non spécifiée par le fabricant peut compromettre la protection de sécurité de l'instrument. Cet instrument ne doit pas être directement connecté à des sujets humains ni utilisé pour la surveillance des patients.</p>
---	--

3 First steps

3.1 Delivery Checklist

First, verify that all items listed on the packing list have been delivered. If you note any omissions or damage, please contact your nearest SIGLENT customer service center or distributor as soon as possible. If you fail to contact us immediately in case of omission or damage, we will not be responsible for replacement.

3.2 Quality Assurance

The oscilloscope has a 3-year warranty (1-year warranty for probe attachments) from the date of shipment, during normal use and operation. SIGLENT can repair or replace any product that is returned to the authorized service center during the warranty period. We must first examine the product to make sure that the defect is caused by the process or material, not by abuse, negligence, accident, abnormal conditions or operation.

SIGLENT shall not be responsible for any defect, damage, or failure caused by any of the following:

- a) Attempted repairs or installations by personnel other than SIGLENT.
- b) Connection to incompatible devices/incorrect connection.
- c) The use of non-SIGLENT accessories or supplies. Furthermore,

SIGLENT shall not be obligated to service a product that has been modified. Spare, replacement parts and repairs have a 90-day warranty.

The oscilloscope's firmware has been thoroughly tested and is presumed to be functional. Nevertheless, it is supplied without warranty of any kind covering detailed performance. Products not made by SIGLENT are covered solely by the warranty of the original equipment manufacturer.

3.3 Maintenance Agreement

We provide various services on the basis of maintenance agreements. We offer extended warranties as well as installation, training, enhancement and on-site maintenance and other services through specialized supplementary support agreements. For details, please consult your local SIGLENT customer service center or distributor.

4 Document Conventions

For convenience, text surrounded by a box border is used to represent the button of the front panel. For example, Print represents the "Print" button on the front panel. Italicized text with shading is used to represent the touchable or clickable menu/button/region on the touch screen. For example, *DISPLAY* represents the "DISPLAY" menu on the screen:

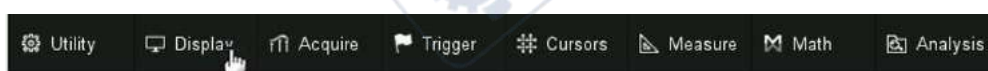

For the operations that contain multiple steps, the description is in the form of "Step 1 > Step 2 >...". As an example, follow each step in the sequence to enter the upgrade interface:

Utility > *System Setting* > *Upgrade*

Press the Utility button on the front panel as step 1, click the *System Setting* option on the screen as step 2, and click the *Update* option on the screen as step 3 to enter the upgrade interface.

5 Getting Started

5.1 Power on

SDS2000X Plus provides two ways for power on, which are:

Power on Line

When the “Power on Line” option is enabled, once the oscilloscope is connected to the AC power supply through the power cord, the oscilloscope boots automatically. This is useful in automated or remote applications where physical access to the instrument is difficult/impossible.

Steps for enabling the “Power on Line” function:

`Utility` > `Power On Line`

Power on by Manual

When the “Power on Line” option is disabled, the power button on the front panel is the only control for the power state of the oscilloscope.

5.2 Shut down

Press the power button to turn off the oscilloscope. Or follow the steps below:

Utility>*Shutdown*

Note:

The Power button does not disconnect the oscilloscope from the AC power supply. The only way to fully power down the instrument is to unplug the AC power cord from the outlet. The power cord should be unplugged from the AC outlet if the scope is not to be used for an extended period of time.

5.3 System Status

Follow the steps below to examine the software and hardware versions of the oscilloscope.

Utility>*System Setting*>*System Status*

See the section "System Status" for details.

5.4 Install Options

A license is necessary to unlock a software option. See the section "Install Option" for details.

6 Probe

The SDS2000X Plus series oscilloscope package includes passive probes as standard accessories. Please visit the website at www.siglent.com for technical data and ordering information.

6.1 Probe Safety

A guard around the probe body provides a finger barrier for protection from electric shock.

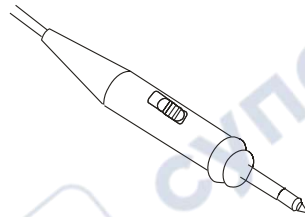

Connect the probe to the oscilloscope and connect the ground terminal to ground before you take any measurements.

Note:

- To avoid electric shock when using the probe, keep fingers behind the guard on the probe body.
- To avoid electric shock while using the probe, do not touch metallic portions of the probe head while it is connected to a voltage source. Connect the probe to the oscilloscope and connect the ground terminal to ground before you take any measurements.

6.2 Probe Compensation

When a probe is used for the first time, you should compensate it to match the input channel of the oscilloscope. Non-compensated or poorly compensated probe may increase measurement inaccuracy or error. The probe compensation procedures are as follows:

1. Connect the coaxial cable interface (BNC connector) of a passive probe to any channel of the oscilloscope.
2. Connect the probe to the “Compensation Signal Output Terminal” (Cal) on the front of the oscilloscope. Connect the ground alligator clip of the probe to the “Ground Terminal” under the compensation signal output terminal.



3. Press the **Auto Setup** button.
4. Check the waveform displayed and compare it with the following.



5. Use a non-metallic driver to adjust the low-frequency compensation adjustment hole on the probe until the waveform displayed is as the “Perfectly compensated”.

7 Quick Start

7.1 Front Panel Overview



- A. **Touch Screen Display:** The display and major functions area. See the "Touch Screen Display" chapter for more details.
- B. **Front Panel:** Includes knobs and buttons. See the chapter "Front Panel" for more details.
- C. **WaveGen:** Built-in waveform generator output.
- D. **Probe Compensation/ Ground Terminal:** Supplies a 0–3.3 V, 1 kHz square wave for compensating the probes.
- E. **USB Host Ports:** Connect the USB host ports to USB storage devices for data transfer or USB mouse / keyboard for control.
- F. **Digital Input Connector:** Receives digital signals from the SPL2016 digital probe.

G. Analog Input Connectors

H. Power Switch

I. **Supporting Legs:** Adjust the supporting legs properly to use them as stands to tilt the oscilloscope for stable positioning of the oscilloscope.

7.2 Rear Panel Overview



- A. **Auxiliary Out:** Outputs the trigger indicator. When Pass / Fail is enabled, outputs the pass / fail signal.
- B. **Ext Trigger Input**
- C. **LAN Port:** Connect the port to the network for remote control.
- D. **USB Ports:** One USB device to connect with a PC for remote control and one USB host to connect with a USB storage device or USB mouse / keyboard.
- E. **AC Power Input**
- F. **Handle**

7.3 Connecting to External Devices/Systems

7.3.1 Power Supply

The standard power supply for the instrument is 100~240 V, 50/60 Hz or 100~120 V, 400 Hz. Please use the power cord provided with the instrument to connect it to AC power.

7.3.2 LAN

Connect the LAN port to the network with a network cable with RJ45 head for remote control.

Follow the steps below to set LAN connection:

```
Utility>System Setting>I/O>LAN Config
```

7.3.3 USB Peripherals

Connect a USB storage device (FAT32 format) to one of the USB host ports for data transfer, or connect USB mouse / keyboard to one of the USB host ports for controlling the instrument.

7.3.4 Auxiliary Output

When Mask Test is enabled, the port outputs the pass / fail signal, otherwise, it outputs the trigger indicator. See the chapter "Mask Test" for more details.

7.3.5 Probes

The SDS2000X Plus series oscilloscope supports active probe and passive probes. The specifications and documents of the probe can be obtained at www.siglent.com.

7.3.6 Logic Probe



To connect the logic probe: Insert the probe, with the correct side facing up, until you hear a “click”.

To remove the logic probe: Depress the buttons on each side of the probe, then pull out it.

8 Touch Screen Display

8.1 Overview

The entire SDS2000X Plus display is a capacitive touch screen. Use your fingers to touch, drag, pinch, spread, or draw a selection box. Many controls that display information also work as “buttons” to access other functions. If you using any mouse, you can click anywhere - that you can touch - to activate a control; in fact, you can alternate between clicking and touching the control, whichever is convenient.



- Menu Bar
- Grid Area
- Trigger Level Indicator
- Cursors

- E. Channel Descriptor box descriptor boxes
- F. Trigger Delay Indicator
- G. Timebase and Trigger descriptor box
- H. Dialog Box

Trigger Level Line (Vertical) and Trigger Delay Indicator (Horizontal) show the trigger position of the waveform.

Cursors show where measurement points have been set. Move the cursors to quickly reposition the measurement point.

Channel Descriptor boxes include analog channels (C1 ~ C4), digital channels (D), math (F1 ~ F2) and reference (Ref). They are located under the grid area, showing the parameters of the corresponding traces. Touching the boxes creates a dialog box.

Timebase and Trigger Descriptor boxes show the parameters of the timebase and trigger respectively. Touching the boxes creates a dialog box for the selected item.

The backlight of the display is adjustable. Follow the steps below to adjust the backlight:

Display > Backlight

8.2 Menu Bar

Menu bar with drop-down menus lets you access set-up dialogs and other functions. All functionality can be accessed through the menu bar. It is not necessary for common operations. You can enter most menus by using the front panel or parameter description labels instead of the menu bar. However, the following operations can only be accessed through the menu bar:

Utility > *Help*

Acquire > *Sequence*

Acquire > *XY Mode*

Analysis > *Mask Test*

Analysis > *Bode Plot*

Analysis > *Power Analysis*

Analysis > *Counter*

8.3 Grid Area

The grid area displays the waveform traces. Traces can be moved by dragging and re-scaled by pinch and spread. The area is divided into 8 (vertical) * 10 (horizontal) grids. The best display effect can be obtained by adjusting the waveform intensity and graticule. Follow the steps below to set these parameters:

Display > Intensity,

Display > Graticule

There are multiple indicators on the grid:

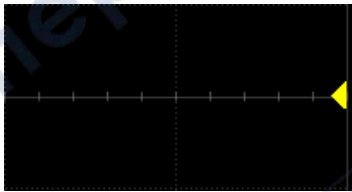

Trigger Level Indicator shows the level where the waveform triggers on the vertical axis.

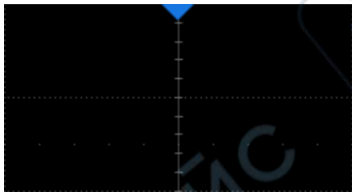

Trigger Delay Indicator locates where the waveform triggers on the horizontal axis... When the trigger position is outside the screen, the direction of the triangle changes to point outside the screen.



Channel Offset Indicator with a channel number shows the offset position of the corresponding channel.

8.4 Channel Descriptor Box

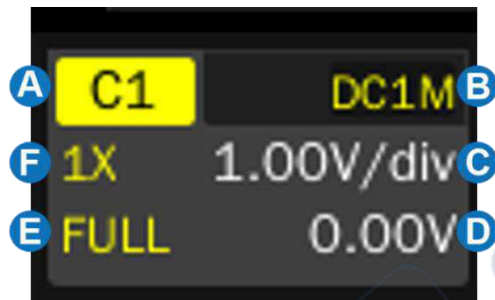

- A. Channel Index
- B. Coupling and Input Impedance
- C. Vertical Scale
- D. Vertical Offset
- E. Bandwidth Information
- F. Probe Attenuation Factor

Bandwidth Information:

20M: 20 MHz bandwidth limit

200M: 200 MHz bandwidth limit

350M: On 500 MHz model, anti-aliasing filter is automatically turned on when the channel is in non-interleaving mode (i.e. sample rate \leq 1 GSa/s). The bandwidth of the anti-aliasing filter is around 350 MHz

FULL: Full bandwidth

Invert Indicator—shows that the current channel is inverted:

I: Invert has been turned on

None: Invert has been turned off

Coupling and Input Impedance:

DC1M: DC coupling, 1 M Ω impedance

DC50: DC coupling, 50 Ω impedance

AC1M: AC coupling, 1 M Ω impedance

AC50: AC coupling, 50 Ω impedance

GND: Ground

Vertical Scale: The scale of each grid in the vertical direction. For example, when the vertical scale is 1.00 V/div, the full scale of the oscilloscope is 1.00 V/div*8 div=8 V.

Vertical Offset: The offset of the channel in the vertical direction. When the vertical offset is 0, the channel offset indicator is located in the middle of the vertical axis.

Probe Attenuation Factor: Set the probe attenuation factor to match the actual attenuation of the probe. The oscilloscope automatically calculates the vertical scale according to the probe attenuation factor. For example, the vertical scale of the oscilloscope is 100mV/div with 1X attenuation, and 1V/div if the attenuation factor is changed to 10X. When inserting a standard 10X passive probe with a probe sense terminal, the oscilloscope will automatically set the factor to 10X.

1X: 1:1 attenuation, suitable for direct coaxial cable connection or passive probes with 1X attenuation

10X: 10:1 attenuation, suitable for general passive probes or active probes with 10X attenuation

100X: 100:1 attenuation, suitable for some high-voltage probes

: Custom attenuation factor

8.5 Timebase and Trigger Descriptor Boxes

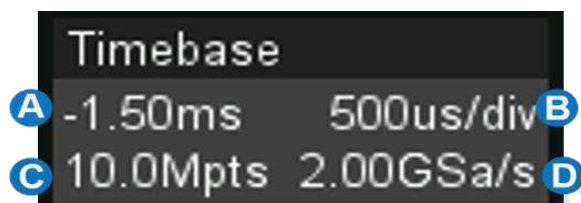

- A. Trigger delay
- B. Horizontal scale
(timebase)
- C. # Samples
- D. Sample Rate

Trigger delay: The time offset of the trigger position. When the trigger delay is 0, the trigger delay indicator is in the center of the horizontal axis of the grid area.

Horizontal scale: Timebase, the time of each grid in the horizontal direction. For example, if the scale is $500 \mu\text{s}/\text{div}$, the time of each grid is $500 \mu\text{s}$, and the full-screen time range of the oscilloscope is $500 \mu\text{s}/\text{div} * 10 \text{ div} = 5 \text{ ms}$.

Samples: The number of sample points on the current screen.

Sample Rate: The current sample rate.

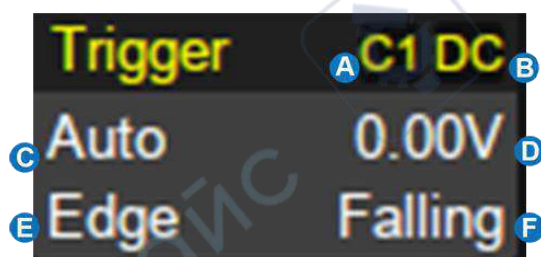

- A. Trigger source
- B. Trigger coupling
- C. Trigger mode
- D. Trigger level
- E. Trigger type
- F. Trigger slope

Trigger source

- C1~C4: Analog channels
- EXT: External trigger channel
- EXT/5: 5x attenuation of external trigger channel
- AC Line: AC mains supply
- D0~D15: Digital channels

Trigger coupling: Coupling mode of the current trigger source. It is only valid when the trigger source is C1~C4, EXT or EXT/5.

- DC: All the signal's frequency components are coupled to the trigger circuit for high-frequency bursts or where the use of AC coupling would shift the effective trigger level.
- AC: The signal is capacitively coupled. DC levels are rejected. See the datasheet for details of the cut-off frequency.
- HFR: Signals are DC coupled to the trigger circuit, and a low-pass filter network attenuates high frequencies (used for triggering on low frequencies). See the datasheet for details of the cut-off frequency.
- LFR: The signal is coupled through a capacitive high-pass filter network, DC is rejected and low frequencies are attenuated. For stable triggering on medium to high-frequency signals. See the datasheet for details of the cut-off frequency.

Trigger mode

- Auto: The oscilloscope will sweep without a set trigger. An

internal timer triggers the sweep after a preset timeout period so that the display refreshes continuously. This is helpful when first analyzing unknown signals. Otherwise, Auto functions the same as Normal when a trigger condition is found.

- Normal: Sweeps only if the input signal meets the trigger condition. Otherwise, it continues to display the last acquired waveform.
- Stop: Stops the acquisition and displays the last acquired waveform.

Trigger level: The source voltage level or levels that mark the threshold for the trigger to fire. Trigger levels specified in Volts normally remain unchanged when the vertical gain or offset is modified.

Trigger type: See the chapter "Trigger" for details.

8.6 Dialog Box

The dialog box on the right side of the screen is the main area for setting the parameters of the selected function.

- A. Title bar. Touching the bar can hide the dialog box, and touching again can open the dialog box.
- B. Parameter setting area.
- C. Scroll bar. When parameters are more than the displayed range, the blue scrollbar will be displayed. By sliding the dialog area up and down, or rolling the mouse wheel, it can scroll to the area not displayed.



To Set Parameters

The SDS2000X Plus provides a couple of different ways to input/select parameters:

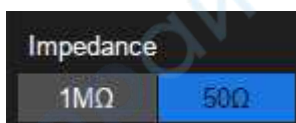

Switch: Sets parameters with two states, such as to enable or disable a function.

Touch the switch region to change from one state to the other.

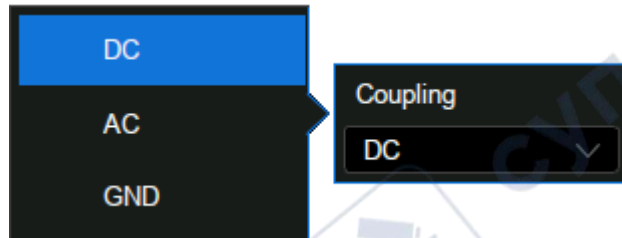

List: Sets parameters with more than two options, such as the coupling mode of channels. Touch the parameter region, and then select the expected option from the pop-up list.

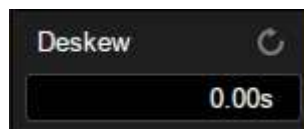

Virtual Keypad: Sets parameters with a numerical value. Touch the parameter region, and the parameter can be adjusted by the universal knob on the front panel; touch the region again, then the virtual keypad appears:

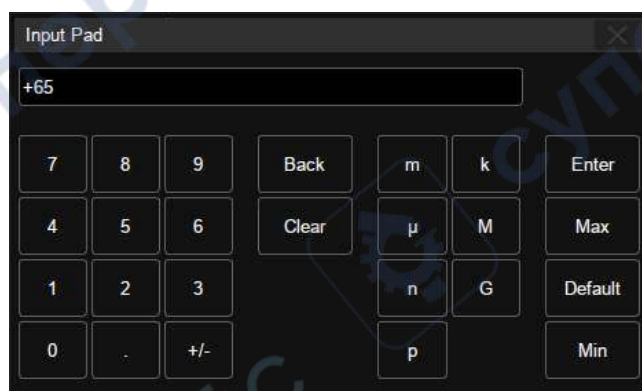

Let's use the operation of setting the "deskew" of a channel as an example: If the expected value is 65 ns, input "65" on the virtual

keypad, and then choose the unit n to complete the operation. On the virtual keypad, touching the button Max, Min, and Default quickly set the parameter to its maximum, minimum and default values.

Hide Dialog Box

When the dialog box is opened, the grid area will be compressed horizontally to display the complete waveform. After setting the parameters, in order to achieve the best waveform display effect, you can touch the title bar in the upper right corner to hide the dialog box. Touching it again can open the dialog box.

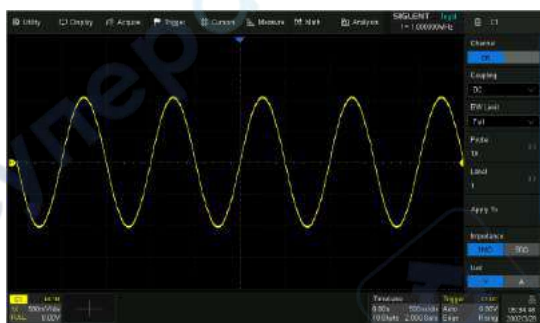

Turn on the Dialog box

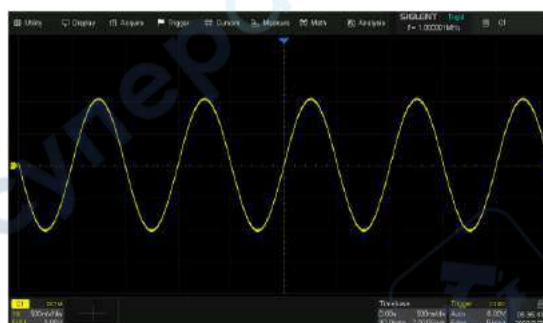

Turn off the Dialog box

8.7 Touch Gestures

Waveforms, cursors and trigger levels can be adjusted and rectangular zone can be drawn by touch gestures in the grid area.

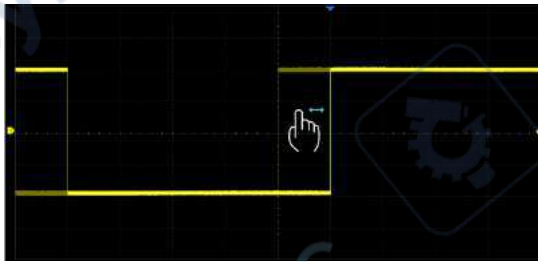

Drag the waveform left and right to move it on the horizontal axis



Pinch and spread the waveform horizontally to re-scale the timebase

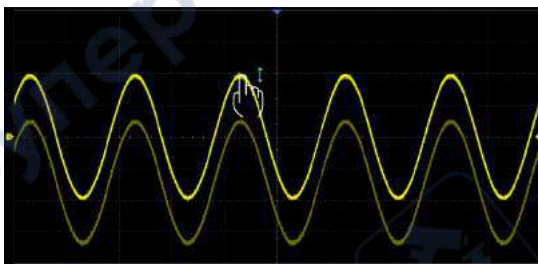

Drag the waveform up and down to move it on the vertical axis

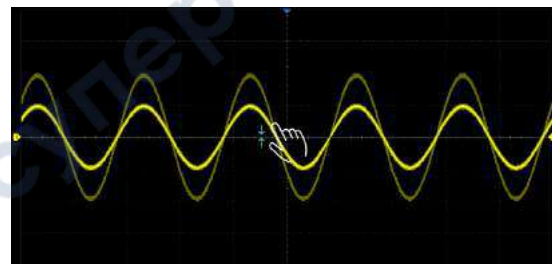

Pinch and spread the waveform vertically to re-scale the vertical gain

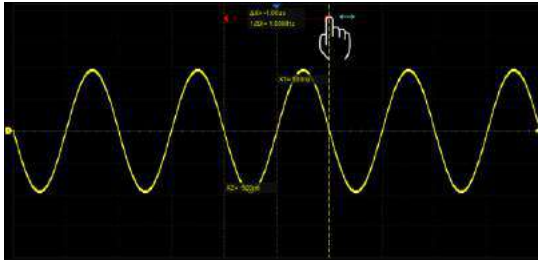

Touch and drag the cursor to move it

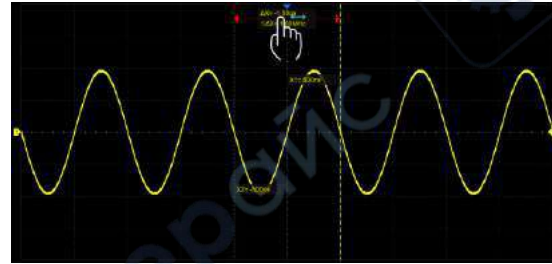

Touch and drag the cursor information region to move the pair of cursors simultaneously

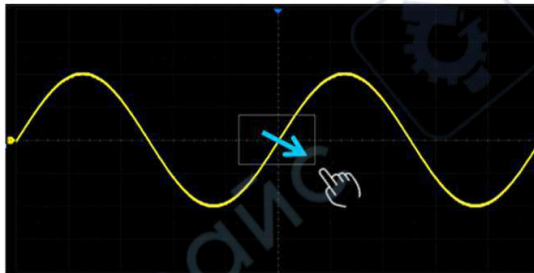

Draw a rectangular box to create a zone or a histogram region. At the beginning of the gesture keep the angle close to 45° so it can be recognized as the drawing box gesture

8.8 Mouse and Keyboard Operation

The SDS2000X Plus user interface features mouse control as well as the touch screen. If the oscilloscope is connected to a USB mouse, you can click on the object with the mouse instead of touching the object. Similarly, if a USB keyboard is connected, you can use the keyboard to input characters instead of using the virtual keyboard.

8.9 Choosing the Language

Follow **Utility** > **System Setting** > **Language** to choose the language. See the section "Language" for details.

9 Front Panel

9.1 Overview



The front panel is designed to operate the basic functions without having to open the software menu. Most of the front panel controls duplicate functionality available through the touch screen display but the operation is more quickly achieved.

All the knobs on the front panel are multi-function. They can be pushed as well as rotated. Pushing a knob quickly recalls a specific function, which is indicated by the silkscreen near to the knob.



9.2 Vertical Control

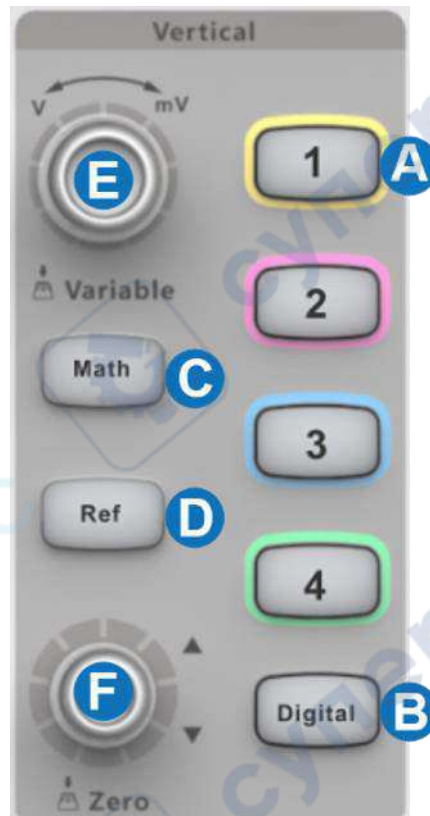

- A. When a channel is disabled, push the channel button to turn it on. When the channel is turned on but inactive, push the button to activate it. When the channel is turned on and activated, push the button to disable it.
- B. Press the button to turn on the digital channel and open the **DIGITAL** dialog box. Press again to turn off the digital channels.
- C. Press the button to turn on the math function and open the **MATH** dialog box. Press again to turn off math function.
- D. Press the button to turn on the reference function and open the **REFERENCE** dialog box. Press again to turn off the reference function.
- E. Analog channels (C1-C4), digital channels (d), math (F1-F2)

and references (Ref) share the same vertical knob. Rotate the knob to adjust the vertical scale (volts/div). Push to alternate between coarse and fine adjustments. When the digital channel is active, rotate the knob to change the selected digital channel.

- F. Analog channels (C1-C4), digital channels (D), math (F1-F2) and references (Ref) share the same offset knob. Rotate the knob to adjust the DC offset or vertical position of the channel. Push to set the offset to zero. When the digital channel is active, rotate the knob to change the position of the selected digital channel.

9.3 Horizontal Control

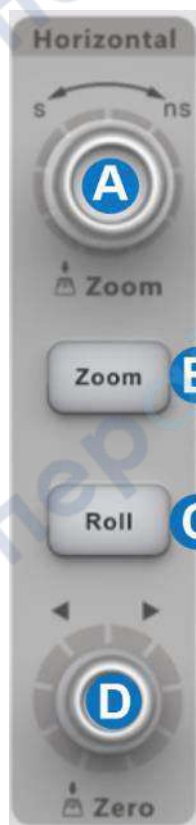

- A. Rotate to adjust the horizontal scale (time/div). Push to enable Zoom. Push again to exit Zoom mode.
- B. Push to enable Zoom. Push again to exit Zoom mode.
- C. Push to enable horizontal Roll. Push again to exit Roll mode. At timebase settings larger than 50 ms/div, it is recommended to set the oscilloscope to Roll mode so that the waveform is displayed in real time.
- D. Rotate to adjust trigger delay. Push to set trigger delay to zero.

9.4 Trigger Control

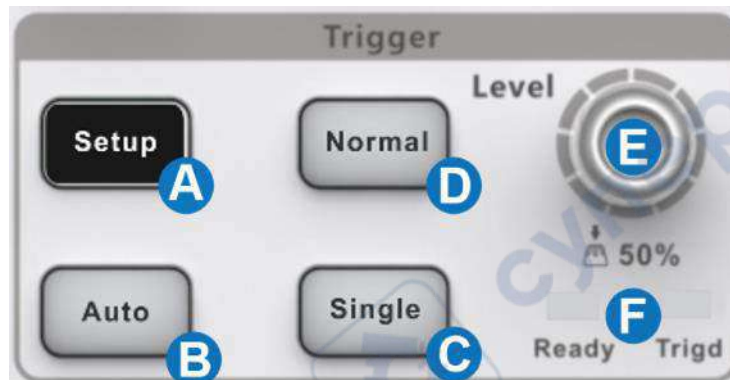

- A. Opens the trigger setup dialog box
- B. Auto mode: Triggers after a preset period if no valid trigger occurs
- C. Single mode: Triggers once when all conditions are met
- D. Normal mode: Triggers repeatedly when all conditions are met
- E. Trigger level adjustment: Push to set the level to 50% of the waveform
- F. Trigger status light, Ready or Trig 'd

9.5 Run/Stop Button



Press the button to switch the acquisition state between Run and Stop. When the state is Run, and the button is illuminated in yellow. When the state is Stop, the button is illuminated in red.

9.6 Auto Setup Button



The oscilloscope will automatically set the vertical scale, horizontal scale, and trigger level according to the input signal to get the optimum waveform display. You can also perform an Auto Setup operation following the steps *Trigger* -> *Auto Setup*.

9.7 Common Function



- A. Press the button to turn on the search function and open the *SEARCH* dialog box. Press again to turn off the search function.
- B. Press the button to turn on navigate function and open the *NAVIGATE* dialog box. Press again to turn off the navigate function.
- C. Press the button to turn on history function and open the *HISTORY* dialog box. Press again to turn off the search function.
- D. Press the button to turn on serial bus decode function and open the *DECODE* dialog box. Press again to turn off the decode function.

9.8 Cursors Control



- A. Push the button to open the cursors setup dialog box
- B. Rotate the knob to move the selected cursor. Push to select a different cursor.

9.9 Universal Knob



When the parameter setting area is highlighted, you can use the Universal Knob to adjust or set the parameter. Press the knob to select an option from the list. The default function of the Universal Knob is to adjust the intensity of the waveform traces.

9.10 Other Buttons



Enables/Disables measurements and recalls the *MEASURE* dialog box.



Performs a screenshot save to an external storage device. The supported format includes .bmp\ .jpg\ .png.



Enables/Disables the touch screen. The LED on the button lights to indicate that the touch screen is working.



Resets the oscilloscope to the default configuration.



Clears the displayed data and any measurements, including display persistence, measurement statistics, average sweeps, and Pass/Fail statistics.



Recalls the *ACQUIRE* dialog box.



Press the button to recall the *DISPLAY* dialog box. The second press turns on Persist and lights the button. Press the button again to turn off Persist.



Recalls the *SAVE/RECALL* dialog box.



Recalls the *UTILITY* dialog box.



Recalls the *AWG* dialog box. The LED on the button lights to indicate the output of the AWG is enabled.

10 Multiple Approaches to Recall Functions

The oscilloscope can recall functions through different approaches.

10.1 Menu Bar



If you are familiar with common current computer programs, you may first choose to access a function by the drop-down menu from the menu bar at the top of the display.

For example, to open the trigger setup dialog box, you can follow the steps below:

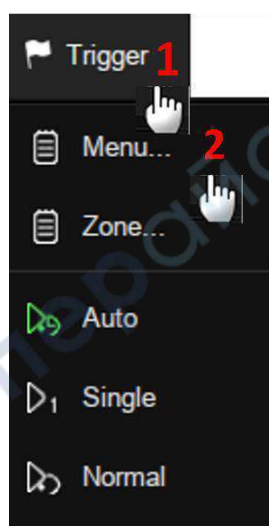

Trigger>Menu

The operations can be completed either by touch or by mouse clicks.

10.2 Descriptor Box

For setup of channels, math, ref, timebase and trigger, there are

dialog boxes at the bottom of the display. For the introduction of the descriptor box, see sections "Channel Descriptor Box" and "Timebase and Trigger Descriptor Box".

For the example above, touch the trigger descriptor box and the trigger setup dialog box will be activated.

Trigger	C1 DC
Auto	0.00V
Edge	Falling

10.3 Shortcut Button on the Front panel

Most of the functions of the oscilloscope can be recalled directly by the shortcut buttons on the front panel. See the chapter "Front Panel" for details.

To open the trigger setup dialog box, press the **Setup** button in the trigger control area on the front panel.



11 Quickly Capture the Signal

This is an example describing how to acquire a signal quickly. In this example, we assume the signal is connected to channel 1 and other channels are disabled.

First, press the channel 1 button to turn on channel 1. The LED on the button lights and the descriptor box of channel 1 is displayed at the bottom of the screen.



Second, press the **Auto Setup** button. The oscilloscope will automatically adjust the vertical scale, horizontal scale, and trigger level according to the input signal to get the optimum waveform display.



Auto Setup will not work on all signal types, especially time-varying bursts or slow signals (< 100 Hz). If Auto Setup cannot achieve desired settings, you can manually adjust the vertical, horizontal, and trigger systems. See the chapters "Vertical Setup", "Horizontal and Acquisition Setup" and "Trigger" for details.

12 Vertical Setup

12.1 Turn on/off a Channel

From the Front Panel

Push the channel button (1-4) to turn on the corresponding channel. Its channel descriptor box and a dialog box will appear on the display. Push the same button again to disable the channel.

From the Touch Screen

Touch the **+** button and then select the expected channel to turn it on, and its channel descriptor box and a dialog box will appear on the display. Touch the channel descriptor box and then touch the **Off** button to disable it.

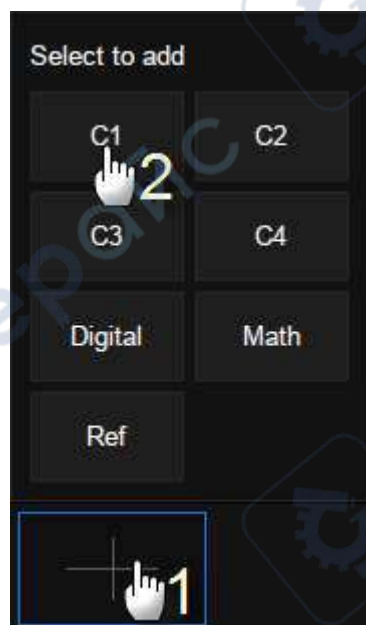

Turn on C1



Turn off C1

12.2 Channel Setup

Touch the channel descriptor box, a quick dialog will pop up. Vertical scale and offset can also be set from this dialog box.

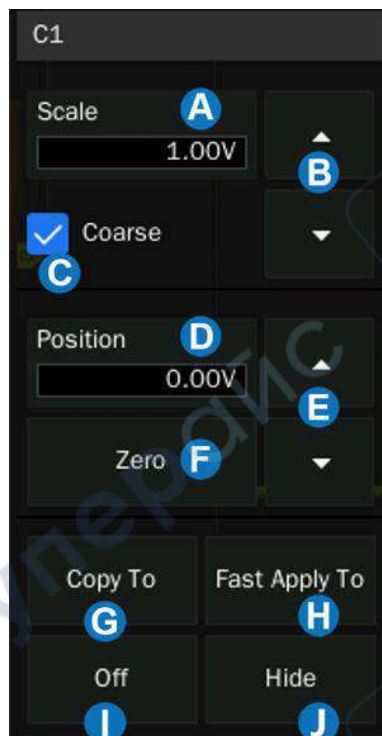

- A. Touch the region to set the vertical scale with the universal knob or virtual keypad
- B. ▲ to increase the vertical scale and ▼ to decrease
- C. Check to coarsely adjust the vertical scale and uncheck to enable fine adjustment
- D. Touch the region to set the offset with universal knob or virtual keypad
- E. ▲ to increase the offset and ▼ to decrease
- F. Set the offset to zero
- G. Copy the setting of current channel to another channel
- H. Quickly apply current channel as source of a specified operation
- I. Disable the channel
- J. Hide or show the trace. Hiding the trace does not disable the channel

The vertical scale can be adjusted in coarse or fine mode. Use fine

mode to scale the display such that the waveform fills the entire display to achieve the best measurement accuracy in the vertical direction. The oscilloscope automatically switches to fine mode when the vertical scale is altered by a touch gesture.

Activating a channel recalls the channel dialog box, displaying more parameters:

- A. Turn channel on/off
- B. Coupling (DC, AC or GND)
- C. Bandwidth limit (Full, 200 MHz or 20 MHz)
- D. Probe attenuation (1X, 10X, 100X or custom)
- E. Set the label text. Click to recall the label setting. Users can customize the text and display of the label
- F. Quickly apply a specified operation (Trigger, Cursor, Measure, FFT, Search, Mask Test, Counter and AWG) to current channel
- G. Impedance
- H. Units for the channel
- I. Deskew
- J. Enable/disable invert
- K. Show or hide channel waveforms

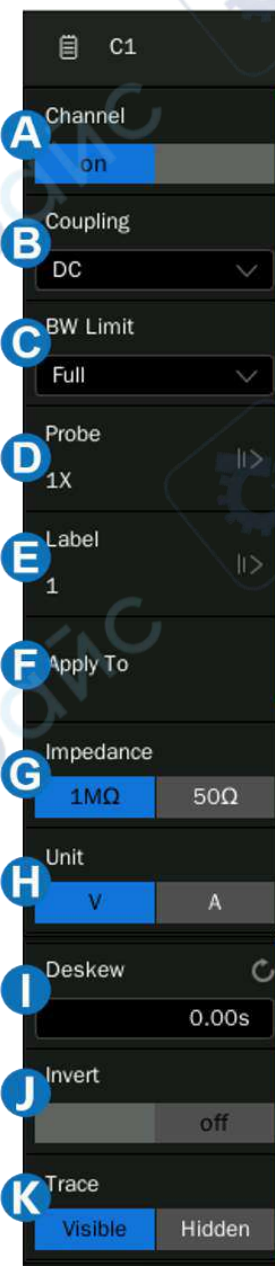

Coupling

- DC: All of the input signal frequency components are passed to the display.
- AC: The signal is capacitively coupled. DC signal components are rejected. See the datasheet for details of the cut-off frequency. AC coupling is suitable for observing AC signals with DC offset, such as power ripple.
- GND: The channel is grounded by an internal switch. GND coupling is used to observe the zero offset error of the analog channels or determine the source of noise in the waveform (from signal or from oscilloscope itself)

Bandwidth Limit

Full bandwidth will pass through signals with high-frequency components, but it also means that noise with high-frequency components can pass through. When the frequency component of a signal is very low, better signal-to-noise ratios (SNR) can be obtained by enabling one of the available bandwidth limits. The SDS2000X Plus provides two bandwidth limit options: 20 MHz and 200 MHz. The bandwidth limit effectively lowers the input frequency response of the input to the selected limit value.

Probe Attenuation

The SDS2000X Plus provides 1X, 10X, 100X and custom probe attenuation factor options. The custom values can be between 10^{-6} ~ 10^6 . The

oscilloscope will automatically convert the vertical scale according to the current probe attenuation factor. For example, the vertical scale of the oscilloscope under 1X attenuation is 100 mV/div, and the vertical scale will be automatically set to 1 V/div if the probe attenuation is changed to 10X. If a standard probe with readout terminal is connected, the oscilloscope will automatically set the probe attenuation to match the probe.

Label

Users can set the label text for channels. Open the label setting dialog box to select the source, customize the label text, and set the display. The source can be C1~C4, F1~F2, and RefA~RefD. The length of the label is limited to 20 characters. The characters beyond this length will not be displayed. When the “Display” option is set to “on”, the label will be displayed on the right side of the channel offset indicator.

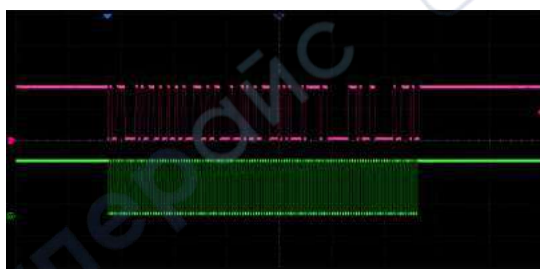

The labels are hidden

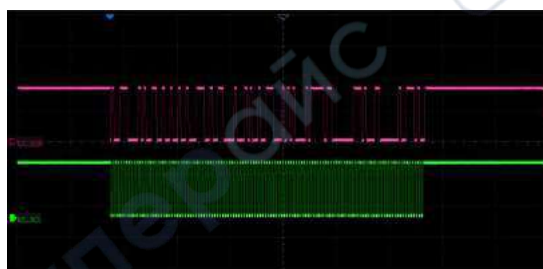

The labels are displayed

Applied to

With this setting, some common functions such as Trigger, Cursor, Measure, FFT, Search, Mask Test, Counter, and AWG can be quickly applied to the selected channel. Once a function is specified, it will switch directly to the function menu and automatically set that channel as

the source.

Impedance

- 1 M Ω : When a passive probe with high impedance is connected, the impedance must be set to 1 M Ω , otherwise the signal will not be detected.
- 50 Ω : Suitable for high-frequency signals transmitted through 50 Ω coaxial cables and can minimize the amplitude distortion caused by impedance mismatching.

Unit

Voltage unit "V" or current unit "A". When using the current probe, the unit should be set to "A".

Deskew

Due to the skew between channels, cables or probes, the delay of signals passing through different measurement paths may be inconsistent. For example, two coaxial cables with a 1-inch difference in length could introduce a skew of more than 100 ps. In some scenarios (e.g. measuring the setup/hold time between clock and data), it may be necessary to compensate the skew between channels.

The method of compensation: Probe the same signal simultaneously using two channels (including the cables or probes that you intend to use for measurements) and adjust the deskew parameter of one channel until the waveforms of the two channels observed on the screen

coincide horizontally.

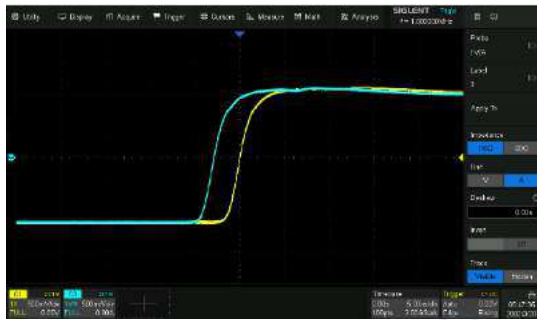

Before deskew



After deskew

Note: When the channel with deskew compensation is the trigger source, the trigger delay indicator does not change as the deskew value changes.

Invert

When invert is enabled, the waveform is displayed 180 degrees opposite to the earth potential. This is a mathematical inversion and does not physically change the actual potential of the input signal.



Before invert



After invert

13 Digital Channels

13.1 Overview



SPL2016 Probe

The SPL2016 is a logic probe designed to monitor up to 16 digital signals at once. The 16 digital channels are separated into two groups and each group has its own threshold, making it possible to simultaneously view data from different logic families.



Note: To avoid personal injury or damage to the logic probe and any associated equipment, the following safety precautions should be noted.

The equipment shall be used only for the purposes specified by the manufacturer. The SPL2016 probe is used only for SIGLENT's special series of oscilloscopes. Protection mechanisms can be compromised if the way the devices connected by the SPL2016 are not used for their intended purpose.

Connect and disconnect correctly. Excessive bending can damage the cable.

Do not use equipment in humid or explosive environment.

Only used indoors. The SPL2016 is designed to be used indoors and should only be operated in a clean, dry environment.

Do not use the equipment when you suspect a problem. Do not use the SPL2016 if any parts are damaged. Maintenance work shall be performed

by maintenance personnel with appropriate qualifications.

Keep the product surface clean and dry.

SDS_2000XP_MSO Option

The software option adds the following functions to the oscilloscope:

- **Digital channel acquisition and analysis** – Acquire and analyze the signals connected to the digital logic probe, including waveform display, save, parameter measurement, etc.
- **Trigger on a digital channel** – Trigger with the digital channel as the trigger source, isolating events of interest.
- **Decode on a digital channel** – Serial protocol decoding of a digital channel requires the installation of the serial decode option.

13.2 Enable/Disable the Digital Channels

Turning on or off the digital channels is similar to analog channels. Digital data can be stored as waveform files. Horizontal cursors and most of the horizontal measurements also apply to digital waveforms.



- A. Digital channel waveform display, which shares the same grid area with the analog channels.
- B. Digital channel descriptor box
- C. Dialog box
- D. Digital channel indicators. Up to 16 digital channels are organized in two groups with different thresholds: D15~D8 and D7~D0. Every channel can be turned on or off individually.
- E. Labels can be set to data, address or custom characters.

From the Front Panel

Press the **Digital** button on the front panel to turn on digital channels and display the waveforms. Press again to turn off.

From the Touch Screen

Click **+** at the bottom of the display and select the "Digital" to turn on; click the digital channel descriptor box, and clicking **Off**

on the pop-up menu to turn off. Refer to the operation in the chapter "Vertical Setup" for details.

13.3 Digital Channel Setup

Touch the digital descriptor box, then the quick menu of digital channel settings pops up above the descriptor box. In the menu height and position of digital channels can be set:

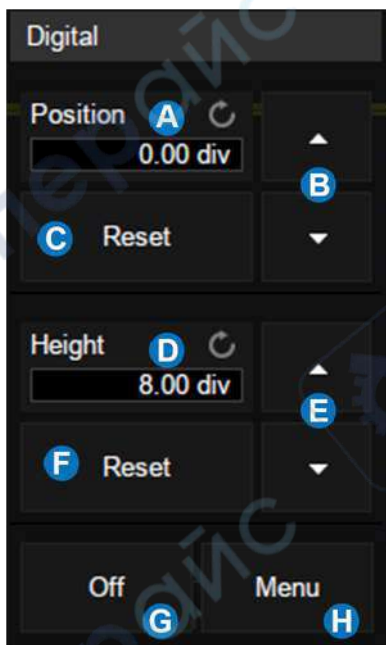

- A. Upper position limit of the digital channel display area. You can use the universal knob or virtual keypad to set it. Decrease the height to provide more adjustment area.
- B. ▲ to increase position and ▼ to decrease the channel location.
- C. Reset the position to default value
- D. The range in height of the digital channels display area. You can use the universal knob or virtual keypad to set it. If the display height covers all of the available divisions, there will not be room to adjust the position.
- E. ▲ to increase and ▼ to decrease the number of divisions occupied by the digital channels
- F. Reset the height to default value
- G. Turn off the digital channels

H. Open digital dialog box on the right side

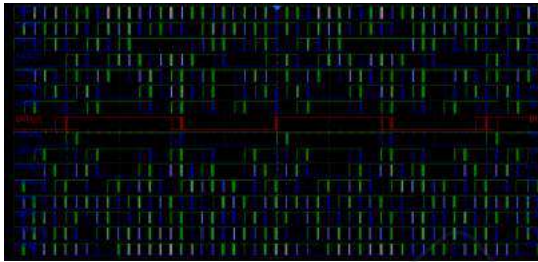

Height=8div, Position=0div

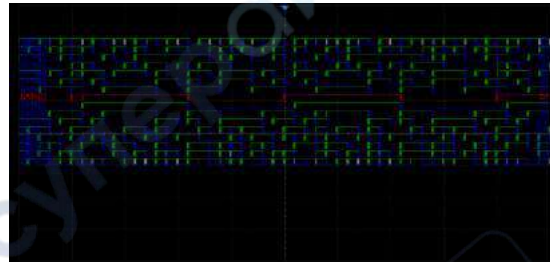

Height=4div, Position=1div

The quick menu only covers the height range and position of the digital channels display area. More settings can be found in the dialog box.

- A. Turn on/off the digital channels
- B. Labels can be set to data, address or custom characters.
- C. The logic threshold of D7~D0. The oscilloscope will automatically set the threshold according to specified logic family, or users can set the threshold by manual using the Custom option.
- D. Logic threshold of D15~D8
- E. Set the channels to be displayed
- F. Deskew setting
- G. Bus setting

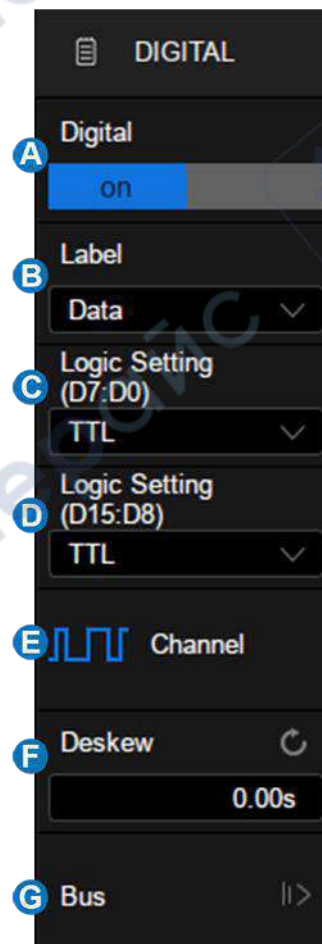

Logic Threshold Setting

The threshold level determines how the input signal is evaluated. The threshold level can be set in the *Logic Setting*. The input voltage less than the threshold is recognized as a '0', and the input voltage greater than the threshold is recognized as a '1'.

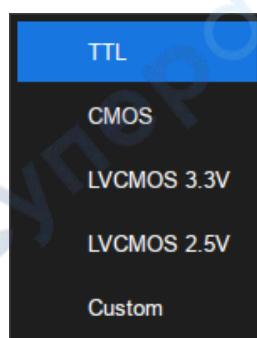
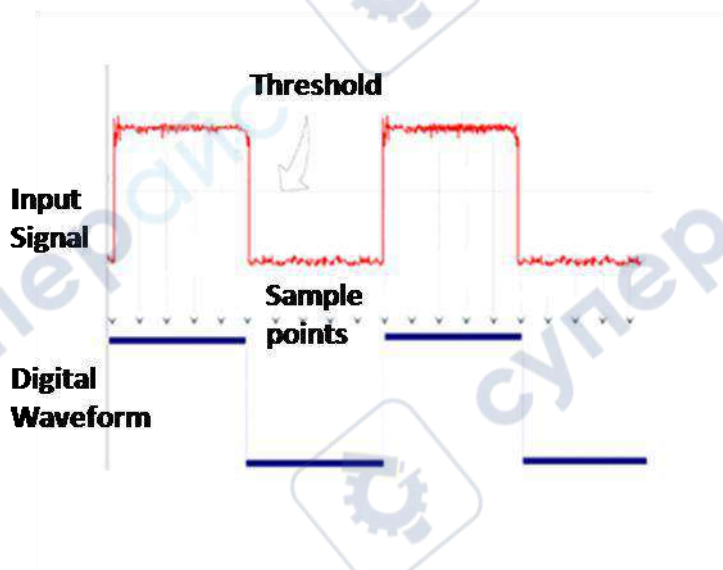

The configurable logical level includes TTL, CMOS, LVC MOS 3.3V, LVC MOS 2.5V and Custom.

The setting range of the custom threshold is $-10.0V$ to $+10.0V$.

14 Horizontal and Acquisition Setup

14.1 Timebase Setup

The timebase setup is used to adjust the scale and offset of the X (horizontal) axis. This setting applies to all analog, digital channels and all math traces except FFT.

Touch the timebase descriptor box, the quick menu of the timebase settings will pop up. In the menu timebase (horizontal scale), delay and other parameters can be set.

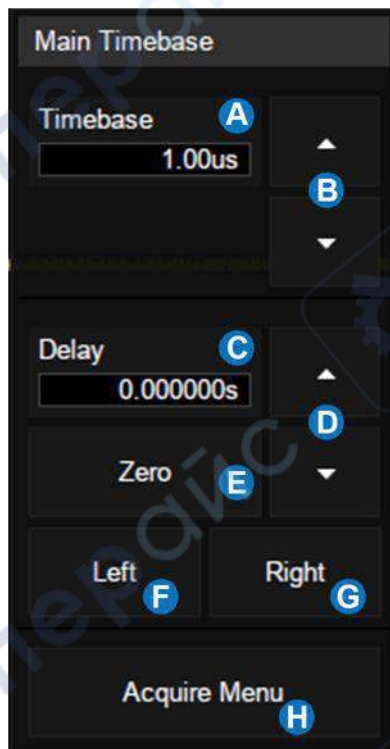

- A. Set the horizontal scale (timebase) by the virtual keypad
- B. ▲ to increase and ▼ to decrease the horizontal scale
- C. Set the trigger delay by the virtual keypad
- D. ▲ to increase and ▼ to decrease the trigger delay
- E. Set the trigger delay to zero
- F. Set the trigger delay to the left part of the screen
- G. Set the trigger delay to the right part of the screen
- H. Open the Acquire dialog box

14.2 Acquisition Setup

14.2.1 Overview

Touch **Acquire Menu** on the quick menu of the timebase settings, or press the **Acquire** button on the front panel, or touch the menu bar **Acquire>Menu** to recall the Acquire dialog box on the right side.

- A. Select the interpolation mode
- B. Select the Acq mode
- C. Select the acquisition mode
(Normal/Peak)
- D. Select the maximum memory depth
- E. Recall the sequence dialog box
- F. Select the vertical resolution.
In 10 bits mode, the bandwidth is limited to around 100 MHz

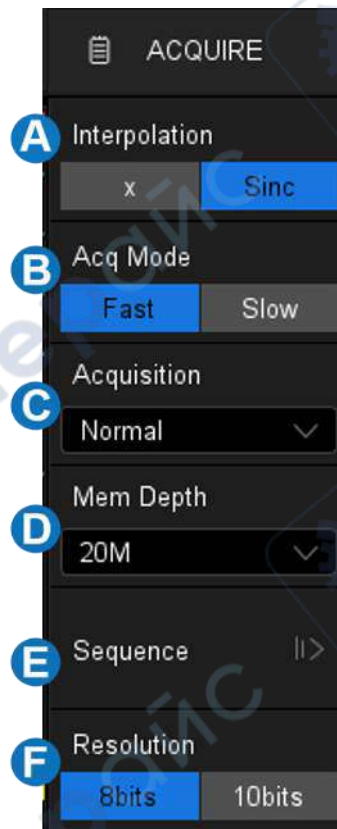

Acquisition: See the section "Acquisition" for details.

Memory Depth: The maximum memory depth that can be supported. According to the formula "acquisition time = sample points x sample interval", setting a larger memory depth can achieve a higher sample rate for a given time base, but more samples require more processing time, degrading the waveform update rate. With 200 Mpts memory depth,

SDS2000X Plus can still run at full sample rate (2 GSa/s) even when set to the 10 ms/div timebase.

Note: The memory depth here is the upper limit of the memory space allocated by the oscilloscope. The actual sample points are related to the current timebase and may be less than memory depth. The actual sample points information can be obtained in the timebase descriptor box (see the section "Timebase and Trigger" for details).

The maximum memory depth in single-channel mode is 2 times that of the dual-channel mode, as the following table:

Single-Channel Mode	Dual-Channel Mode
20k	10k
200k	100k
2M	1M
20M	10M
200M	100M

Single-channel mode (interleaving mode): Only one of C1/C2 is turned on, and only one of C3/C4 is turned on.

Dual-channel mode (non-interleaving mode): Both C1/C2 are turned on, or both C3/C4 are turned on.

Interpolation -- At small timebase settings, the number of original points on the screen may be less than the number display pixels in the grid area, so interpolation is necessary to display a continuous

waveform. For example, at 1 ns/div timebase and 2 GSa/s sample rate, the number of original points is 20, but the grid area includes 1000 horizontal pixels. In this case, the oscilloscope needs to interpolate the original points by 50.

- **X**: Linear interpolation, the simplest way of interpolation, connects two original points with a straight line.
- **Sinc**: $\text{Sin}(x)/x$ interpolation, the original point is interpolated according to the Nyquist reconstruction formula, which has a good time-domain recovery effect for sine wave. But for step signals/fast rise times, it will introduce false overshoot due to the Gibbs phenomenon.

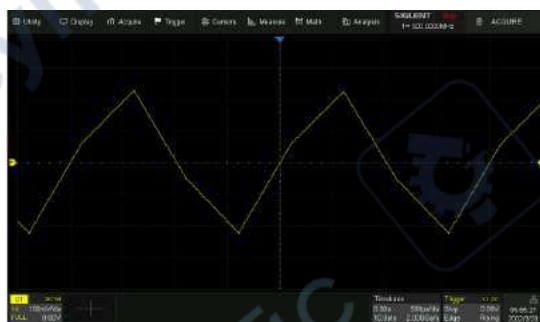

X Interpolation



Sinc Interpolation

Acq mode -- "Fast" is the default setting. The SDS2000X Plus provides a very high waveform update rate in fast mode. "Slow" mode will slow down the waveform update on purpose.

Resolution -- The vertical resolution. "8-bits" is the default setting. In "10-bits" mode, the vertical resolution is 4x better, while the bandwidth is limited to about 100 MHz.

14.2.2 Acquisition

The acquisition mode is used to determine how to acquire and process the signal.

Normal: The oscilloscope samples the signal with an equal time interval. For most waveforms, the best display effect can be obtained using this mode.

Peak: Peak detect mode. The oscilloscope acquires the maximum and minimum values of the signal within the sample interval so that the peak (maximum - minimum) in the interval is obtained. This mode is effective to observe occasional narrow pulses or spurs with a low sample rate, but the noise displayed is larger. In peak mode, the oscilloscope will display all pulses with a pulse width longer than 400 ps.

In the following example, a narrow pulse sequence with a pulse width of 3.4 ns and a period of 200 Hz is sampled at 2 MSa/s sample rate in normal mode and peak mode. As we can see, because the sample interval (500 ns) is much larger than the pulse width (3.4 ns), it is difficult to capture the narrow pulses in normal mode, but peak mode can ensure that each pulse is captured.



Normal mode



Peak mode

14.2.3 Roll Mode

Press the **Roll** button on the front panel to enter roll mode. In this mode, the waveform moves across the screen from right to left, similar to a strip chart recorder. The horizontal delay control of the waveform will be disabled when roll mode is active. It only operates at timebase values of 50 ms/div and above.

If you would like to stop the display in Roll mode, press the **Run/Stop** button. To clear the display and restart an acquisition in Roll mode, press the **Run/Stop** button again.

14.2.4 Sequence

Touch **Acquire** > **Sequence** to recall sequence dialog box.

- A. Turn on or off sequence
- B. Set the segment

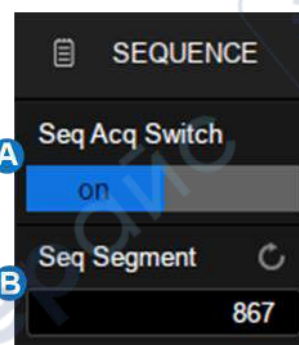

Sequence mode is a fast acquisition mode, which divides the memory depth to multiple segments (up to 90,000), each of which stores a single shot. In sequence mode, the oscilloscope only acquires and stores data without processing and displaying, until the specified segments are acquired. As a result, the dead time between trigger events is minimized, thus greatly improving the waveform update rate.

If sequence mode is enabled, the display will not update until all of the sequences have been acquired. The SDS2000X Plus can achieve a minimum $2\mu\text{s}$ trigger interval in Sequence mode, corresponding to a waveform update rate of 500,000 wfm/s.

After the acquisition is finished, the oscilloscope will map all the segments together to the screen. If you need to view and analyze each frame separately, history mode will help (see the section "History" for details). History mode provides timestamp labels for each segment.

In addition to minimizing the dead time, another advantage of Sequence mode is that it can capture and record rare events over long time periods. The oscilloscope can capture multiple events that satisfy the trigger conditions, ignoring the periods of no interest between adjacent events, thus maximizing the use of waveform memory. You can use the full accuracy of the acquisition timebase to measure selected segments.

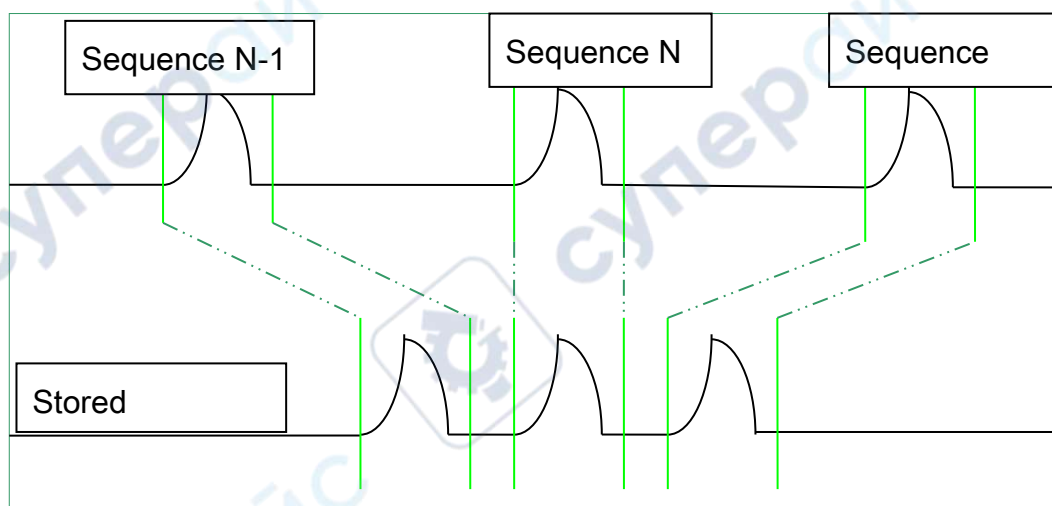

Example:

Input a pulse sequence with a period of 50 ms to C1. The rise time of the pulse is 2 ns, while the fall time is 100 ns. Pulse width is 108 ns, and amplitude is 1.6 Vpp. Press the **AutoSetup** button on the front panel.

Set the coupling mode of C1 to DC50 Ω , and vertical scale to 500 mV/div, vertical offset to 0. Set the trigger level to 0.

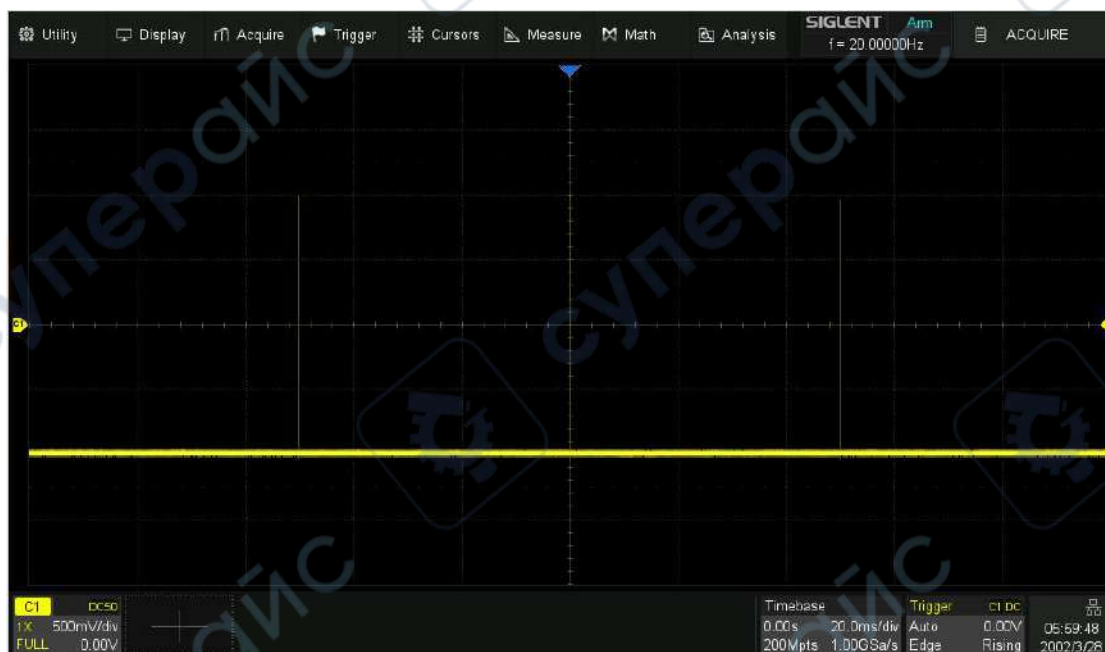

In normal mode, 5 pulses can be obtained on the screen with the sample rate of 1 GSa/s at the maximum memory depth.

Set the trigger mode to "Single", the timebase to 50 ns/div. Turn on the Sequence mode, and set the segments to maximum (5,000 in this example, up to 90,000 depending on the number of samples at the current time base). Wait patiently until the acquisition completes, then all the waveforms satisfying the trigger conditions are displayed onto the screen.



In Sequence mode, there is no waveform displayed on the screen until the acquisition is completed. During acquisition, there is a counter on the screen indicating the number of segments that have been acquired.



In the example, 5000 pulses can be obtained with the sample rate of 2 GSa/s at the maximum memory depth.

14.3 History

Press the **History** button on the front panel or touch *Analysis* > *History* to recall history dialog box.

- A. Turn on or off history mode
- B. Specify the frame index
- C. Set the playing mode
- D. Play backward, pause and play forward
- E. Turn on or off the list
- F. List time type
- G. Set the time interval between two frames when playing automatically
- H. Enable “Stop on Search Event” function, which allows to navigate search events across history frames.
- I. List, displays the frame index and time label for each frame.

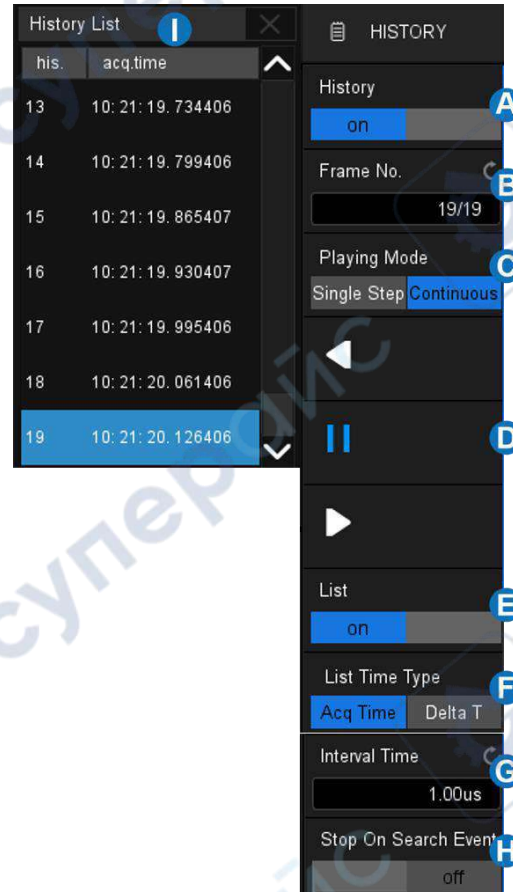

The oscilloscope automatically stores acquired frames. It can store up to 90,000 frames but the number may vary due to the memory depth

and timebase settings. Turn on history mode, then the stored frames can be recalled and measured.

Continue with the example in the section above. In Sequence mode, all waveforms that satisfy the trigger conditions are mapped to the display. If you need to observe a single frame, you can use history mode.

To enable history mode, touch the *Frame No.* area twice, then the virtual numeric keypad pops up. Input the number "412" to specify the 412th segment (frame).

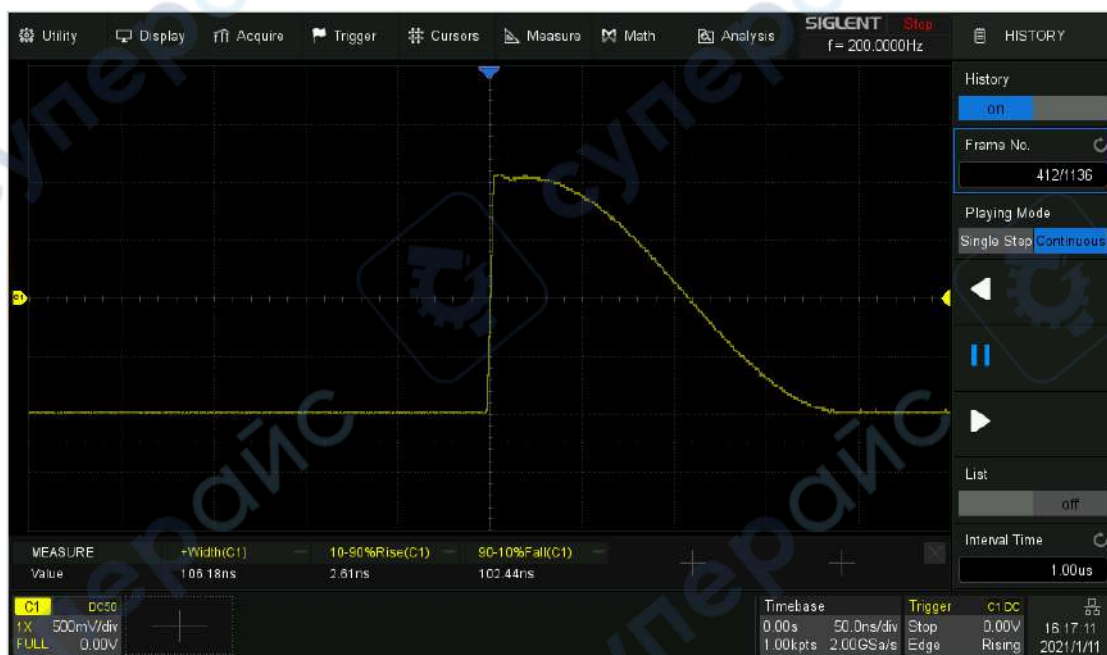

Observing the 412th frame captured by Sequence in history mode

Touch the *List* area, turn on the list, in which the time label corresponding to the 5412th waveform is displayed. The time resolution is microseconds. Time label types include *AcqTime* or *Delta T*, *AcqTime* corresponds to the absolute time of the frame, synchronized with the real-time clock of the oscilloscope; *Delta T* is the acquisition time

interval between adjacent two frames, it is shown as 50 ms in the following diagram, which is consistent with the period of the actual waveform.

his.	acq.time
5406	00:51:37.495635
5407	00:51:37.545635
5408	00:51:37.595635
5409	00:51:37.645635
5410	00:51:37.695635
5411	00:51:37.745635
5412	00:51:37.795635

Acq Time label

his.	delta t
5406	00:00:00.050000
5407	00:00:00.050000
5408	00:00:00.050000
5409	00:00:00.050000
5410	00:00:00.050000
5411	00:00:00.050000
5412	00:00:00.050000

Delta T label

In addition to manually specifying a frame, history mode supports autoplay.

Press the  softkey to replay the waveform from the current frame to the first.

Press the  softkey to stop replay.

Press the  softkey to replay the waveform from the current frame to the last.

Touch the *Interval Time* area to control the speed of automatic play.

In the process of automatic play, the list will automatically scroll to the current frame.

14.4 Zoom

The SDS2000X Plus supports waveform zoom in the horizontal direction. Press down the horizontal knob on the front panel to turn on the zoom function.

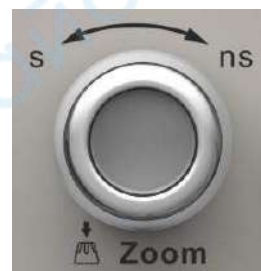

When the Zoom function is on, the waveform area is divided into upper and lower parts. The area of about 1/3 height above is the main window, and the area of about 2/3 height below is the zoom window. Touch a window to activate it.



The area not covered by the gray background in the main waveform area is the region to be zoomed in (zoom area). When the zoom window is activated, the zoom area can be expanded or compressed by rotating the horizontal and vertical scale knob. Rotating the horizontal and vertical position knob to move the position of the region. When the main window is activated, the scale knobs and position knobs are used

to change the scale and delay/offset of the main window. The operations above can also be performed by different gestures. Below is the example of changing the setting on horizontal directions by gestures:

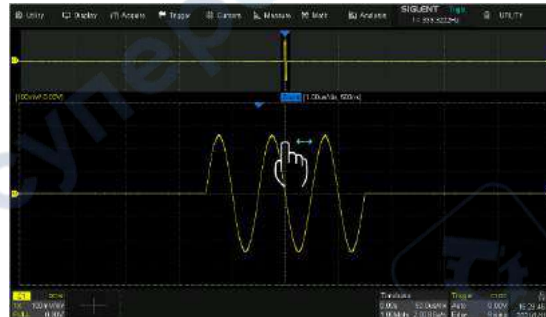

Adjust the horizontal position of the zoom area by dragging left and right in the zoom area of the main window or waveform in Zoom window



Adjust the horizontal position of the waveform by dragging left and right in the gray area of the main window

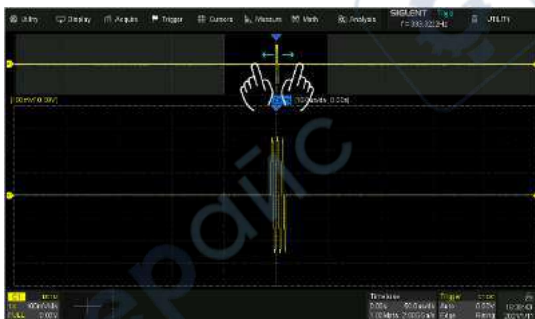

Adjust the horizontal scale of the Zoom window by horizontal pinch and spread in the zoom area of the main window or in the Zoom window

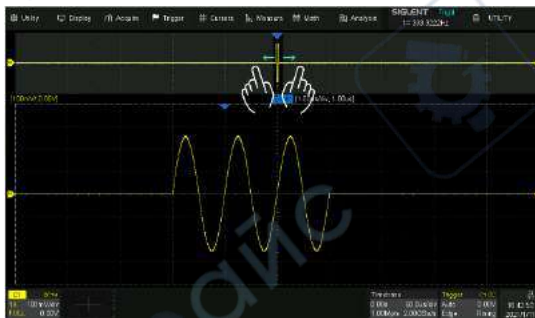

Adjust the horizontal scale of the main window by pinch and spread in the gray area of the main window

15 Trigger

15.1 Overview

The oscilloscope only acquires waveforms of interest (i.e. the ones that satisfy the trigger condition) and aligns all trigger events at the trigger position to form a stable waveform display. The trigger is one of the most important features of an oscilloscope since we can only analyze a signal that we are able to trigger in a reliable and stable manner.

The trigger position is movable on the display. The following diagram shows the structure of the acquisition memory. The acquisition memory is divided into pre-trigger and post-trigger buffers and the boundary between them is the trigger position. Before the trigger event arrives, the oscilloscope fills the pre-trigger buffer first, and then continuously updates it in FIFO mode until the trigger event arrives. After the trigger event, the data fills the post-trigger buffer. When the post-trigger buffer is full, an acquisition is completed.

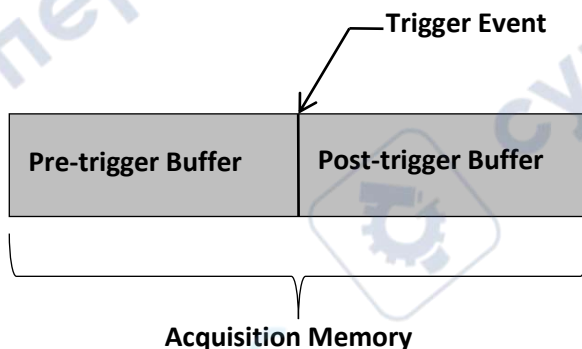

Below are the definitions of the states in the process of filling the acquisition memory:

Arm: The pre-trigger buffer is not full, and the oscilloscope does not respond to any trigger events.

Ready: The pre-trigger buffer is full, and the oscilloscope is waiting for the trigger event.

Trig' d: A trigger event is detected and the oscilloscope starts to fill the post-trigger buffer.

Trigger settings should be based on the features of the input signal. For example, a sine wave with a repeatable period can be triggered on the rising edge; for capturing hazards in a combinational logic circuit, the pulse trigger can be set. You need to have some knowledge of the signal-under-test to quickly capture the desired waveform.

15.2 Trigger Setup

Touch the trigger descriptor box to display the quick menu of trigger settings. The trigger setup dialog box is displayed on the right side of the screen.

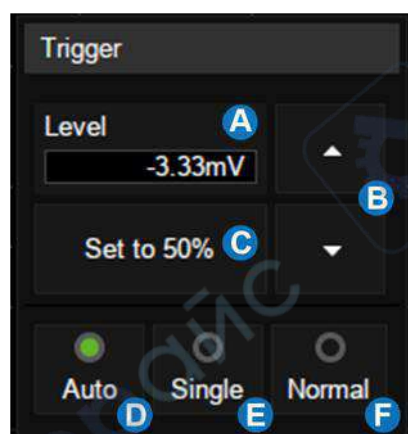

- A. Touch the level region and rotate the **Level** knob on the front panel to adjust trigger level; touch the region again and the virtual keypad will be available
- B. ▲ to increase and ▼ to decrease the trigger level
- C. Set trigger level to the vertical center of the waveform automatically
- D. Set the trigger mode to "Auto", which is equivalent to pressing the `Auto` button on the front panel
- E. Set the trigger mode to "Single", which is equivalent to pressing the `Single` button on the front panel
- F. Set the trigger mode to "Normal", which is equivalent to pressing the `Normal` button on the front panel

- A. Select trigger type
- B. Select the trigger source
- C. Select the trigger slope (When the trigger type is "Edge", "Slope" and other specific types)
- D. Set holdoff (None/Time/Events)
- E. Set trigger coupling mode (DC/AC/LF Reject/HF Reject)
- F. Enable/disable Noise Rejection. When Noise Reject is on, the trigger hysteresis is increased, so the noise immunity of the trigger circuit is better. As a compromise, the trigger sensitivity degrades
- G. Set the Zone trigger

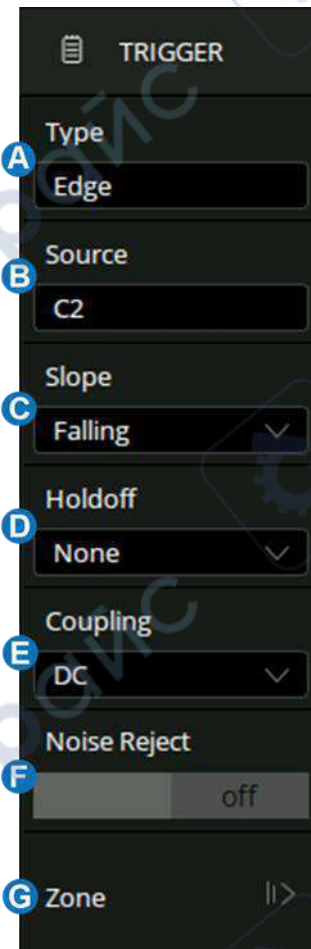

Trigger Related Label

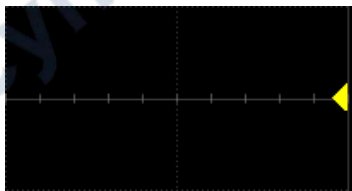

Trigger level Indicator



Horizontal 0 position Indicator



Horizontal 0 position (out of screen) Indicator

15.3 Trigger Level

Both analog and digital triggers must have a correct trigger level value. The oscilloscope judges whether a waveform satisfies the trigger condition when it crosses the trigger level. If it does, the crossing time is the trigger position. In the following figure, the trigger condition is set as to capture a rising edge. When the signal with positive slope crosses the trigger level, the trigger condition is satisfied and the time point the signal crosses the level is the trigger position.

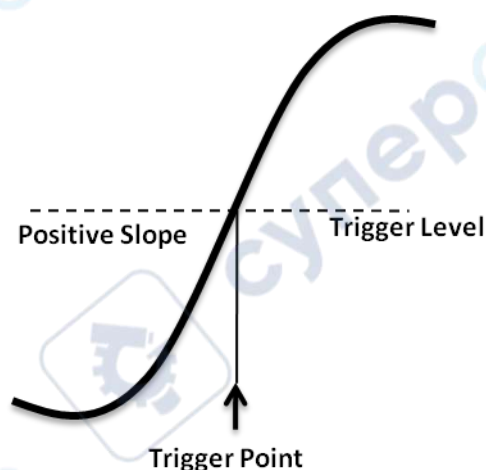

In some special trigger, the system will automatically set the trigger level, such as using AC Line as the trigger source.

15.4 Trigger Mode

The trigger mode determines how the oscilloscope acquires waveforms.

Auto: An internal timer triggers the sweep after a preset timeout period if no trigger has been found so that the oscilloscope

continuously updates the display whether a trigger happens or not. Auto mode is suitable for unknown signals or DC signals.

Note: In Auto mode, if the signal satisfies the trigger conditions but cannot trigger the oscilloscope stably, it may be that interval between two trigger events exceeds the timeout period. Try Normal mode in this case.

Normal: Triggers and acquisitions only occur when the trigger conditions are met. Otherwise, the oscilloscope holds the last waveform on the display and waits for the next trigger. Normal mode is suitable for acquiring:

- Only events specified by the trigger settings
- Rare events

Single: Captures and displays a single frame which satisfies the trigger conditions, and then stops. The following trigger events are ignored until the Single acquisition is restarted. Single-mode is suitable for:

- One-shot events or periodic signals, such as power-on/off waveforms on a power rail
- Rare events

15.5 Trigger Type

15.5.1 Overview

The trigger modes of the SDS2000X Plus are digital designs. Compared

with analog trigger circuits, digital triggers can not only greatly optimize trigger precision, trigger jitter, but also support multiple trigger types and complex trigger conditions.

	Edge -- Trigger on a rising edge, falling edge or both
	Slope -- Trigger when an edge crosses two thresholds which lie inside or outside a selected time range
	Pulse --Trigger at the end of a pulse when the pulse width lies inside or outside a selected time range
	Video --TV trigger on falling edge
	Window --Trigger when the signal leaves the widow region.
	Interval --Trigger on the second edge when the time between the edges is inside or outside a selected time range
	Dropout --Trigger when the signal disappears for longer than the Dropout value.
	Runt --Trigger when a pulse crosses the 1st threshold but not the 2nd before re-crossing the 1 st threshold again
	Pattern -- Trigger when pattern condition transitions from false to true. All inputs set to DC coupling
	Serial --Trigger on specified condition in a serial bus. See the chapter "Serial Trigger and Decode" for details.

15.5.2 Edge Trigger

Edge trigger distinguishes the trigger points by seeking the specified edge (rising, falling, rising & falling) and trigger level. Trigger source and slope can be set in the trigger dialog box.

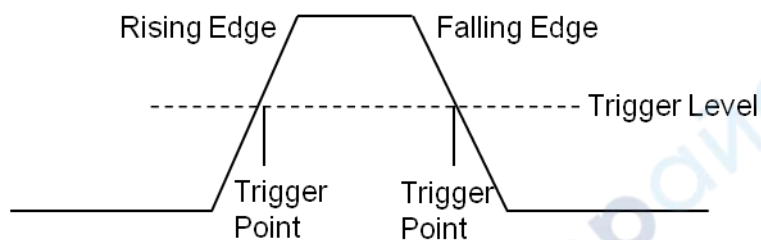

Touch the **Source** area to select trigger source, and touch the **Slope** area to select rising, falling or alter.

Rising -- Only trigger on the rising edge

Falling -- Only trigger on the falling edge

Alter -- Trigger on both rising edge and falling edge

Holdoff, coupling, and noise reject can be set in edge trigger, see the sections " Holdoff", " Trigger Coupling" and " Noise Reject" for details.

Note: Press the **Auto Setup** button, and the oscilloscope will set the trigger type to Edge.

15.5.3 Slope Trigger

The slope trigger looks for a rising or falling transition from one level to another level in the specified time range. For example, positive slope time is defined as the time difference between the two crossing points of trigger level lines A and B with the positive edge as shown in the figure below.

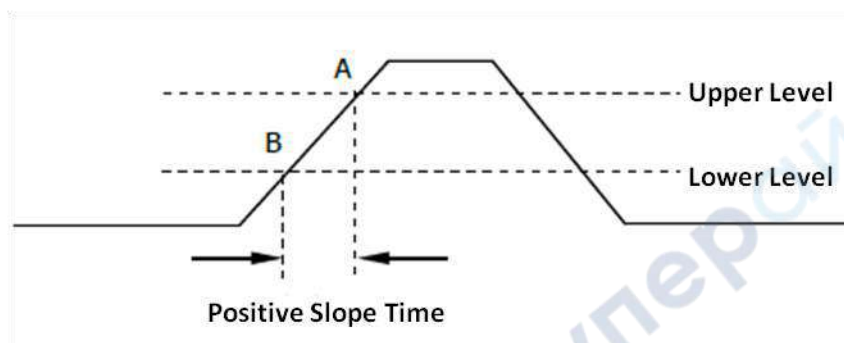

Touch the *Source* area to select trigger source, and touch the *Slope* area to select rising or falling.

Rising -- Only trigger on the positive slope

Falling -- Only trigger on the negative slope

Adjust Upper/Lower Level

The slope trigger requires upper and lower trigger levels. When the trigger type is slope trigger, touch the trigger descriptor box, the pop-up quick menu will show two levels.

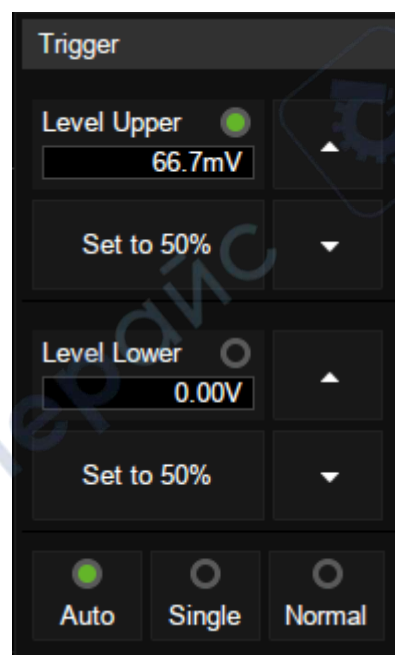

The upper/lower level can be set in the following two ways:

1. Touch the *Level Upper* area in the quick menu to select the upper level, and then set the level value by the virtual keypad or the **Level** knob on the front panel. To set the lower level is similar.

2. Use the **Level** knob on the front panel directly to set the level value. Press the knob to switch between upper and lower level, and rotate it to set the value.

The lower level should always be less than or equal to the upper level. In the trigger descriptor box, the lower level is displayed.

Set Limit Range

Touch the *Limit Range* area in the trigger dialog box to select the time condition and set the corresponding time in the *Upper Value/Lower Value* area.

Less than a time value (\leq) -- Trigger when the positive or negative slope time of the input signal is lower than the specified time value.

Great than a time value (\geq) -- Trigger when the positive or negative slope time of the input signal is greater than the specified time value.

Within a range of time value ($[-, -]$) -- Trigger when the positive or negative slope time of the input signal is greater than the specified lower limit of time and lower than the specified upper limit of time value.

Outside a range of time value ($--][--$) -- Trigger when the positive or negative slope time is greater than the specified upper limit of time and lower than the specified lower limit of time value.

Holdoff, coupling, and noise reject can be set in slope trigger, see the sections " Holdoff", " Trigger Coupling" and " Noise Reject" for details.

15.5.4 Pulse Trigger

Trigger on a positive or negative pulse with a specified width. Trigger source, polarity (positive, negative), limit range and time value can be set in the trigger dialog box.

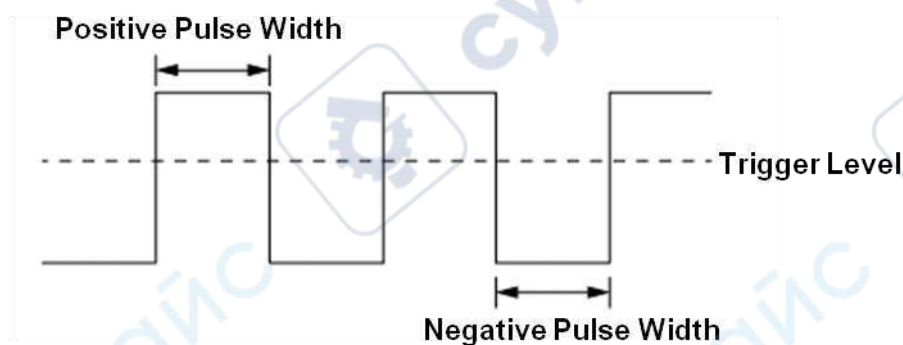

Less than a time value (\leq) -- Trigger when the positive or negative pulse time of the input signal is lower than the specified time value. Below is an example of trigger condition is set to positive pulse width $< 100\text{ns}$



Great than a time value (\geq) -- Trigger when the positive or negative pulse time of the input signal is greater than the specified time value. Below is an example of trigger condition is set to positive pulse width $> 100\text{ns}$



Within a range of time value ($[-, -]$) -- Trigger when the positive or

negative pulse time of the input signal is greater than the specified lower limit of time and lower than the specified upper limit of the time value. Below is an example in which the trigger condition is set to $100\text{ ns} < \text{positive pulse width} < 300\text{ ns}$.

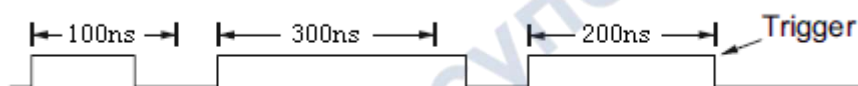

Outside a range of time value ($--$)[$--$] -- trigger when the positive or negative pulse time of the input signal is greater than the specified upper limit of time and lower than the specified lower limit of the time value.

Holdoff, coupling, and noise reject can be set in pulse trigger, see the sections " Holdoff", " Trigger Coupling" and " Noise Reject" for details.

15.5.5 Video Trigger

The video trigger can be used to capture the complicated waveforms of most standard analog video signals. The trigger circuitry evaluates the vertical and horizontal interval of the waveform based on the video trigger settings you have selected. The SDS2000X Plus supports standard video signal for NTSC (National Television Standards Committee), PAL (Phase Alternating Line), HDTV (High Definition Television) and a custom video signal trigger.

Source, standard and synchronization mode can be set in the video trigger dialog box. When the synchronization mode is "Select", line and field can be specified.

Touch the *Standard* and select the video standard. The SDS2000X Plus supports the following video standards:

TV Standard	Scan Type	Sync Pulse
NTSC	Interlaced	Bi-level
PAL	Interlaced	Bi-level
HDTV 720P/50	Progressive	Tri-level
HDTV 720P/60	Progressive	Tri-level
HDTV 1080P/50	Progressive	Tri-level
HDTV 1080P/60	Progressive	Tri-level
HDTV 1080i/50	Interlaced	Tri-level
HDTV 1080i/60	Interlaced	Tri-level
Custom		

The table below shows the parameters of the custom video trigger:

Frame Rate	25Hz, 30 Hz, 50 Hz, 60 Hz	
Of Lines	300 ~ 2000	
Of Fields	1, 2, 4, 8	
Interlace	1:1, 2:1, 4:1, 8:1	
Trigger Position	Line	Field
	(line value)/1(1:1)	1
	(line value)/2 (2:1)	1, 2, 3, 4, 5, 6, 7, 8

	(line value)/4(4:1)	1, 2, 3, 4, 5, 6, 7, 8
	(line value)/8(8:1)	1, 2, 3, 4, 5, 6, 7, 8

Line value: The number of lines set in the *Of Lines* (300 ~ 2000).

In the custom video trigger type, the corresponding "Of Fields" varies with the selection of the "Interlace" ratio. Therefore, the number of fields selected and the number of lines corresponding to each field can also be varied. If the "Of Lines" is set to 800, the correct relationship between them is as follows:

Of Lines	Interlace	Of Fields	Trigger Line	Trigger Field
800	1:1	1	800	1
800	2:1	1/2/4/8	400	1/1~2/1~4/1~8
800	4:1	1/2/4/8	200	1/1~2/1~4/1~8
800	8:1	1/2/4/8	100	1/1~2/1~4/1~8

Set the video trigger for video signal

Touch *Sync* for trigger mode selection, video trigger mode has "Any" and "Select" options. In "Any" mode, the video signal can be triggered on any line that meets the conditions. In "Select" mode, the signal can be triggered by a specified field and a specified line.

For progressive scanning signals (e.g. 720p/50, 720p/60, 1080p/50, 1080p/60), only the specified line can be selected to trigger when the synchronization mode is "Select".

For interlaced scanning signals (such as NTSC, PAL, 1080i/50, 1080i/60, Custom), when the synchronization mode is "Select", the specified line and the specified field can be selected to trigger.

The following table shows the corresponding relations between line and field for all video standards (except for Custom)

Standard	Field 1	Field 2
NTSC	1 to 263	1 to 262
PAL	1 to 313	1 to 312
HDTV 720P/50、720P/60	1 to 750	
HDTV 1080P/50、1080P/60	1 to 1125	
HDTV 1080i/50、1080i/60	1 to 563	1 to 562

To gain familiarization with the video trigger, try these two examples:

- Trigger on a specific line of video (NTSC standard)
- Use "Custom" to trigger video signals

Trigger on a Specific Line of Video

Video trigger requires that any analog channel can be used as the trigger source with a synchronization amplitude greater than 1/2 grid. The example below sets to trigger on Field 1, Line 22 using the NTSC video standard.

1. Press the **Setup** button on the front panel to open the trigger menu.

2. In the trigger menu, touch *Type*, select "Video".
3. Touch the *Source* and select CH1 as the trigger source.
4. Touch the *Standard* and select the "NTSC".
5. Touch the *Sync* and select the "Select" to make the Field and Line optional, then select "1" in the "Field", and set the "Line" to "22" by using the universal knob or the virtual keypad.



Trigger on a Specific Line of Video (NTSC)

Use "Custom" to Trigger Video Signals

Custom video trigger supports video signals with frame rates of 25, 30, 50 and 60 Hz respectively, and the specified row is within the range of 300 to 2000. The following describes how to trigger a "Custom" video signal.

1. Press the **Setup** button on the front panel to open the trigger menu.
2. In the trigger menu, touch the *Type*, select the "Video".

3. Touch the *Source* and select CH1 as the trigger source.
4. Touch the *Standard* and select the "Custom".
5. Touch the *Custom Setting* to open the custom setting menu, touch the *Interlace* to select the required interlace ratio (assuming that the interlace ratio is 8:1). Then set the frame rate, select the number of lines and the number of fields.
6. Touch the *Sync* to select the synchronization mode for the input signal:
 - a) Select the "Any" mode, and the signal can be triggered on any line that meets the trigger condition.
 - b) Select the "Select" mode, then set the specified line and the specified field to trigger the signal. Assuming that the "Field" is set to 8, you can select any field from 1 to 8, and each field can choose any line from 1 to 100.

15.5.6 Window Trigger

Window trigger is similar to edge trigger, except that it provides an upper and a lower trigger level. The instrument triggers when the input signal passes through the upper level or the lower level.

There are two kinds of window types: Absolute and Relative. They have different trigger level adjustment methods. Under the Absolute window type, the lower and the upper trigger levels can be adjusted separately. The relative window provides adjustment for the Center value to set the window center and a Delta value to set the window range. In this

mode, the lower and the upper trigger levels always move together.

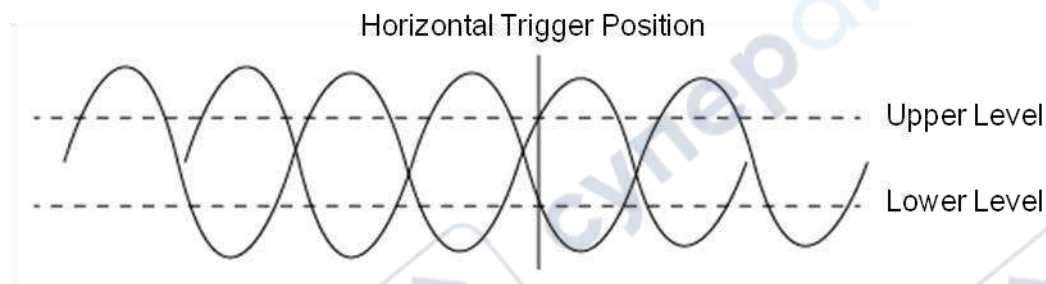

- If the lower and the upper trigger levels are both within the waveform amplitude range, the oscilloscope will trigger on both rising and falling edges.
- If the upper trigger level is within the waveform amplitude range while the lower trigger level is out of the waveform amplitude range, the oscilloscope will trigger on the rising edge only.
- If the lower trigger level is within the waveform amplitude range while the upper trigger level is out of the waveform amplitude range, the oscilloscope will trigger on the falling edge only.

To set window trigger via the Absolute window type

Refer to "Adjust Upper/Lower Level" in the section "Slope Trigger".

To set window trigger via the Relative window type

When the window trigger type is set to "Relative", touch the trigger descriptor box. The pop-up menu will show two user-defined parameters: "Level +/-Delta" and "Level Center".

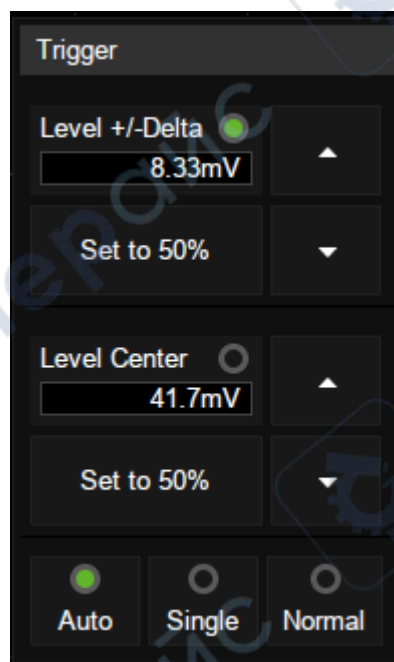

The above two parameters can be set in the following two ways:

1. Select the parameter in the *Level +/-Delta* area of the quick menu, then set the parameter value by the virtual keypad or the Level knob on the front panel. Setting the center level is similar.
2. Directly use the **Level** knob on the front panel. Press the knob to switch between "Level +/-Delta" and "Center Level", and rotate it to set values.

Note: "Level +/-Delta" represents half of the actual window area. For example, when the value is 200 mV, it actually represents a range of ± 200 mV, which is a 400 mV window.

Holdoff, coupling, and noise reject can be set in window trigger, see the sections " Holdoff", " Trigger Coupling" and " Noise Reject" for details.

15.5.7 Interval Trigger

Trigger when the time difference between the neighboring rising or falling edges meets the time limit condition.

When the trigger condition is set as an interval between two neighboring rising edges and it is less than the set time value, the trigger diagram is as follows:

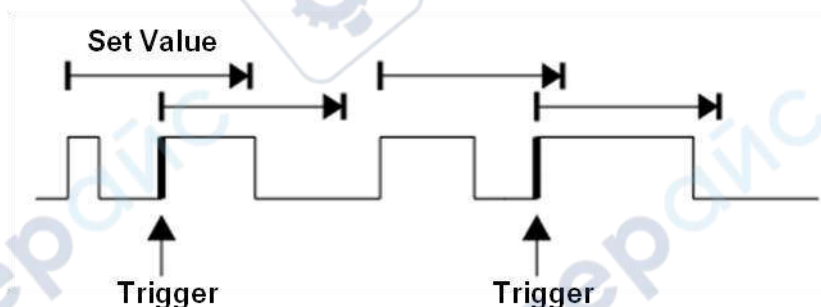

Trigger source, slope (rising, falling), limit range and time value can be set in the trigger dialog box. Holdoff, coupling, and noise reject can be set in the interval trigger, see the sections "Holdoff", "Trigger Coupling" and "Noise Reject" for details.

15.5.8 Dropout Trigger

Dropout trigger includes two types: Edge and state.

Edge

Trigger when the time interval (ΔT) from when the rising edge (or falling edge) of the input signal passes through the trigger level to when the neighboring rising edge (or falling edge) passes through the trigger level is greater than the set time, as shown in the figure

below:

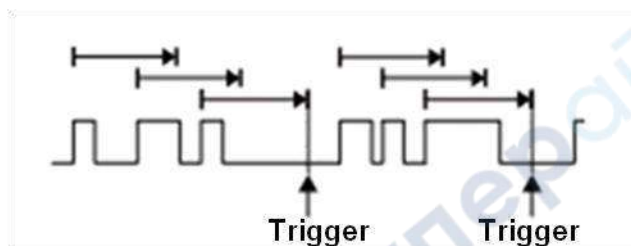

State

Trigger when the time interval (ΔT) from when the rising edge (or falling edge) of the input signal passes through the trigger level to when the neighboring falling edge (or rising edge) passes through the trigger level is greater than the set time, as shown in the figure below:

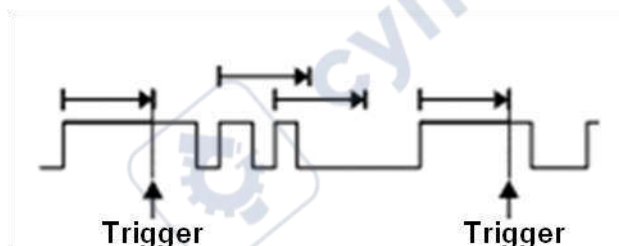

Trigger source, slope (rising, falling), dropout type and time value can be set in the trigger dialog box. Holdoff, coupling, and noise reject can be set in the dropout trigger, see the sections " Holdoff", " Trigger Coupling" and " Noise Reject" for details.

15.5.9 Runt Trigger

Runt trigger looks for pulses that cross one threshold but not another as shown in the figure below:

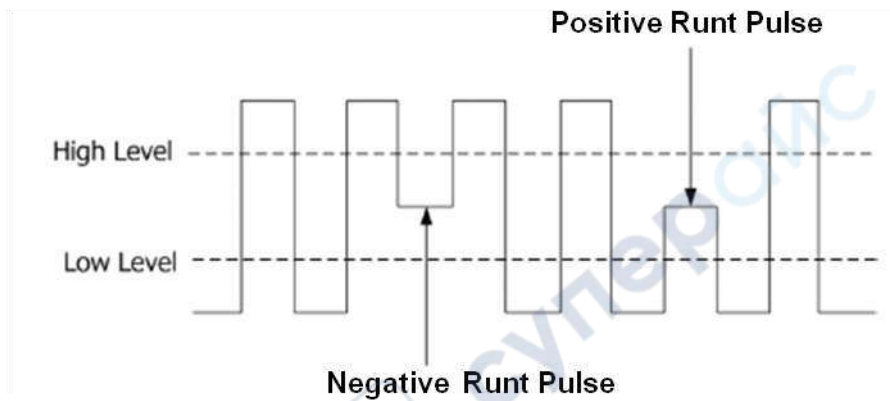

- A positive runt pulse across through the low level but not the high level.
- A negative runt pulse across through the high level but not the low level.

Holdoff, coupling, and noise reject can be set in the dropout trigger, see the sections " Holdoff", " Trigger Coupling" and " Noise Reject" for details.

15.5.10 Pattern Trigger

The Pattern trigger identifies a trigger condition by looking for a specified pattern. The SDS2000X Plus provides 4 patterns: logical AND, OR, NAND and NOR combination of the channels. Each channel can set to "Low", "High" or "Don't Care". If all channels are set to "Don't Care", the oscilloscope will not trigger. When the pattern is logical AND or NOR, the oscilloscope triggers when the combined result transfers from True to False; when the pattern is logical OR or NAND, the oscilloscope triggers when the combined result transfers from False to True.

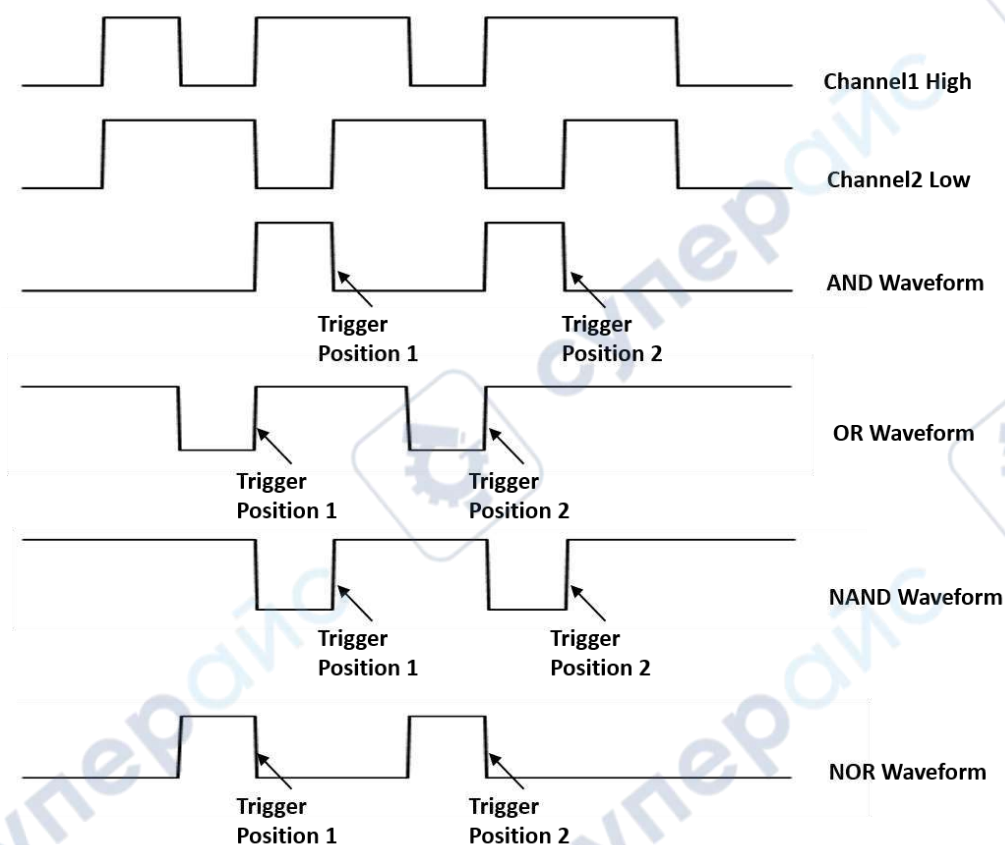

Logic (AND, OR, NAND, NOR), source, limit range, and time value can be set in the trigger dialog box. When the logic is "OR" or "NAND", the setting of the time limit is invalid.

Source Setting

Touch the *Source Setting* area to recall the following dialog box and set up for each channel separately. Each channel can be set to "Low", "High" or "Don't Care". The threshold can be determined by setting the *Level Value*.

When digital channels are turned on, the logic state of the digital channel can also be set in the source setting dialog box.

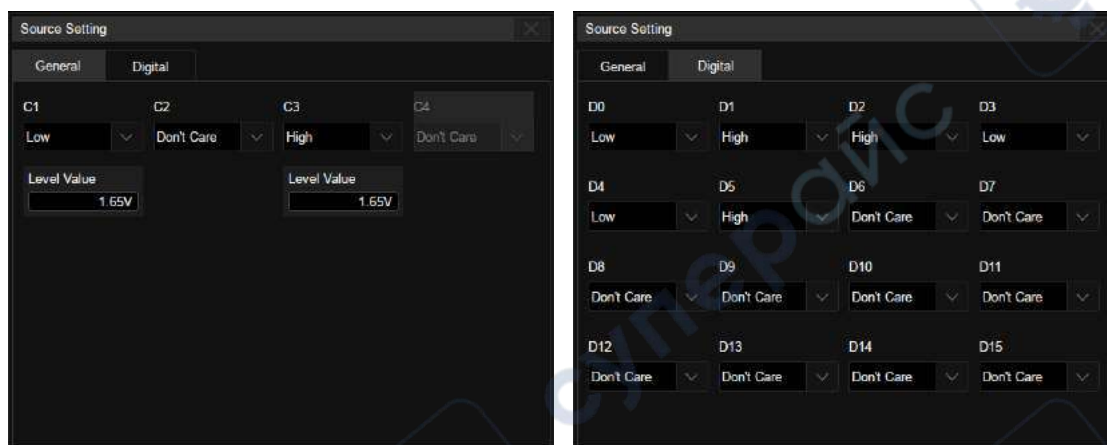

Logic settings of analog channels

Logic settings of digital channels

Limit Range

When the logic is "AND" or "NOR", the time limit condition is available. This setting is particularly useful to filter the hazard signals of combinational logic.

When the logic is "OR" or "NAND", the time limit setting is not supported.

Holdoff can be set in pattern trigger, see the sections " Holdoff" for details.

15.6 Trigger Source

The trigger sources supported by each trigger type are different. See the table below for details:

Trigger Type	C1~C4	EXT, EXT/5	AC Line	D0~D15
Edge	√	√	√	√
Slope	√	×	×	×
Pulse	√	×	×	√
Video	√	×	×	×
Window	√	×	×	×
Interval	√	×	×	√
Dropout	√	×	×	√
Runt	√	×	×	×
Pattern	√	×	×	√
Serial	√	×	×	√

15.7 Holdoff

Holdoff is an additional condition for triggers and can be used to stabilize the triggering of complex waveforms (such as a pulse series). It can be set to a time or number of events.

Holdoff by Time

Holdoff time is the amount of time that the oscilloscope waits before re-arming the trigger circuitry. The oscilloscope will not trigger until the holdoff time expires.

Use the holdoff to trigger on repetitive waveforms that have multiple edges (or other events) between waveform repetitions. You can also use holdoff to trigger on the first edge of a burst when you know the minimum time between bursts.

For example, to achieve a stable trigger on the repetitive pulses shown in the figure below set the holdoff time (t) to $200 \text{ ns} < t < 600 \text{ ns}$.

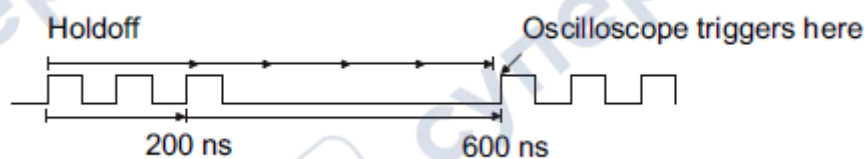

Holdoff by Event

The holdoff event is the number of events that the oscilloscope counts before re-arming the trigger circuitry. The oscilloscope will not trigger until the counter tracking holdoff events reaches the set value.

In the following figure, the holdoff event is set to 3, and the signal is triggered on the fourth edge.



Parameter **Start Holdoff On** defines the initial position of holdoff.

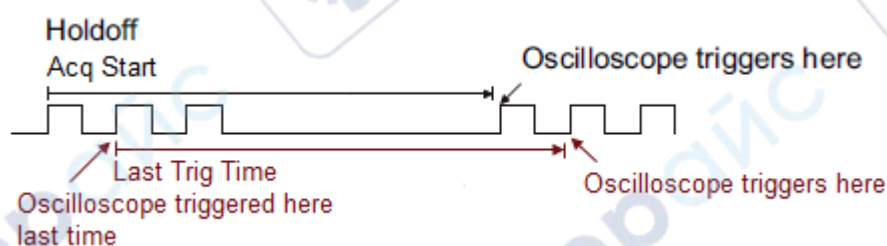

Acq Start-- The initial position of holdoff is the first time point satisfying the trigger condition. In the example above, each holdoff starts from the first rising edge of the pulse sequence.

Last Trig Time--The initial position of holdoff is the time of the last trigger. In the example above, the last trigger position is at the second rising edge of the pulse sequence and the second holdoff starts from that point.

15.8 Trigger Coupling

The coupling setting of a trigger is only valid when the trigger source is C1~C4, EXT or EXT/5.

- DC: All of the signal's frequency components are coupled to the trigger circuit for high-frequency bursts or where the use of AC coupling would shift the effective trigger level.
- AC: The signal is capacitively coupled. DC levels are rejected. See the datasheet for details of the cut-off frequency.
- HFR: Signals are DC coupled to the trigger circuit and a low-pass filter network attenuates high frequencies (used for triggering on low frequencies). See the datasheet for details of the cut-off frequency.
- LFR: The signal is coupled through a capacitive high-pass filter network, DC is rejected and low frequencies are attenuated. For stable triggering on medium to high-frequency signals. See the datasheet for details of the cut-off frequency.

15.9 Noise Reject

Noise Reject adds additional hysteresis to the trigger circuitry. By increasing the trigger hysteresis, the noise immunity becomes better but the trigger sensitivity degrades.

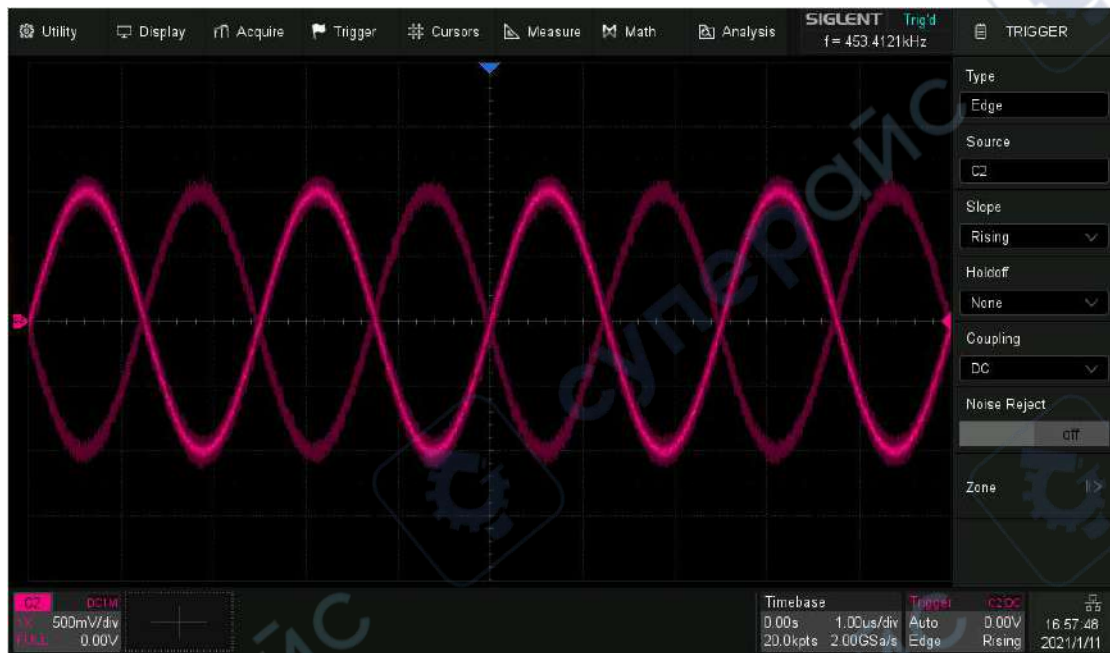

Noise Reject = Off



Noise Reject = On

15.10 Zone Trigger

The SDS2000X Plus includes a zone trigger to help isolate elusive

glitches. There are two user-defined areas: Zone1 and Zone2. Users can set the property of each zone as “intersect” or “not intersect” as an additional condition to further isolate the interesting event quickly. “Intersect” only includes events that occur within the zone. “Not-intersect” events include all events that occur outside of the zone.

Touch *Trigger* > *Zone* to recall zone dialog box:

- A. Turn on or off zone trigger
- B. Select the source: C1~C4
- C. Turn on or off zone1
- D. Set the property of zone1: Intersect or Not intersect
- E. Set the coordinate of zone1. The range is within the waveform area
- F. Turn on or off zone2
- G. Set the property of zone2: Intersect or Not intersect
- H. Set the coordinate of zone2. The range is within the waveform area

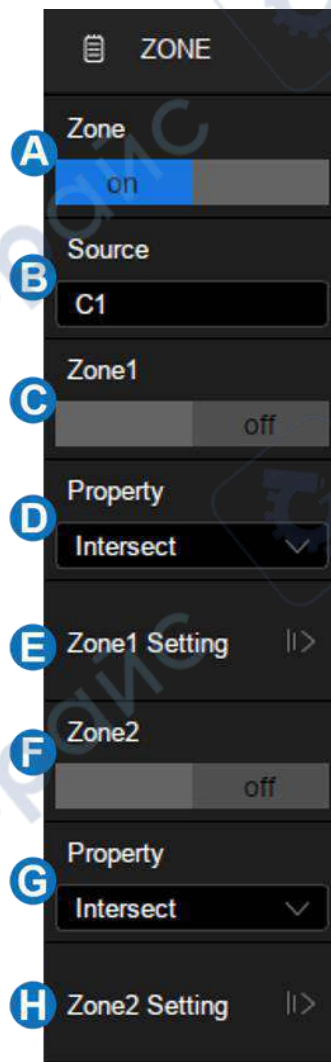

The zones can be created and moved by gestures or by setting *Zone* > *Zone Setting* in the dialog box. The color of the zone's outline is consistent with the color of the specified source (Channel 1 = Yellow,

etc...).

Gesture

When the zone trigger is turned on, touch-and-hold on any position within the waveform area and draw a rectangular box, as shown in the following figure:

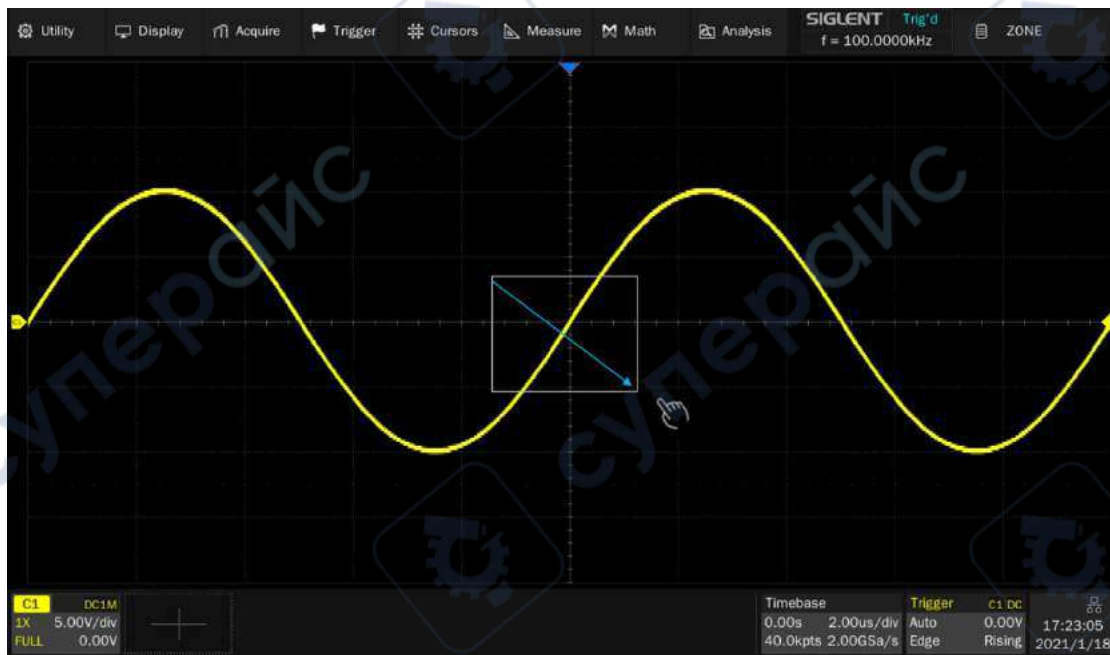

When the finger moves out of the screen, a menu pops up for selecting the zone and setting the zone properties:



Once a zone is created, it can be moved by dragging. Just touch and hold the zone box and use a dragging gesture.

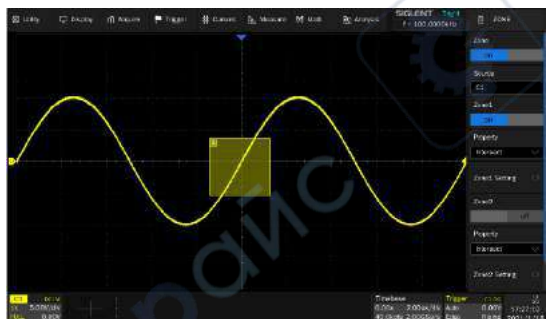

Select C1 as the source, turn on zone1, and set the property as "Intersect"

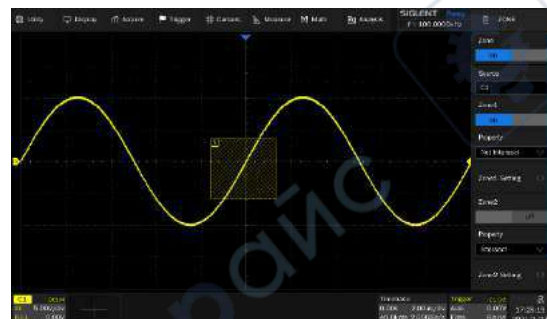

Select C1 as the source, turn on zone1, and set the property as "Not Intersect"

Dialog Box

Touch **Zone** > **Zone Setting** to recall the dialog box.

- A. Set the left border of the zone
- B. Set the right border of the zone
- C. Set the top border of the zone
- D. Set the bottom border of the zone
- E. Return to previous menu



Touch the regions above to set the value by the universal knob or the virtual keypad.

Note: If zone1 and zone2 are both turned on, the result of the "AND" operation in two zones becomes the qualifying condition of triggering.

Below is an example in which we want to capture a waveform of bus contention using the SDS2000X Plus:

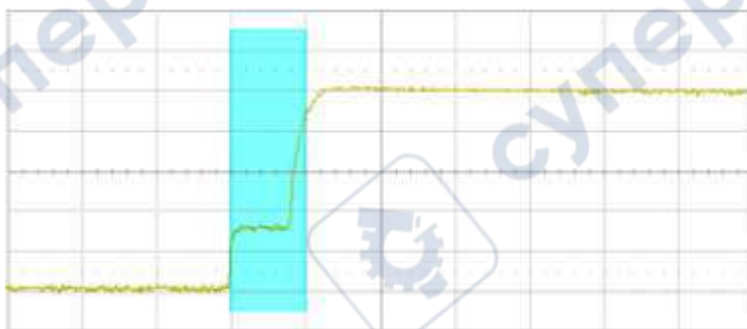

With a simple edge trigger, it is unlikely to trigger consistently on this anomaly. Thanks to the high waveform update rate of the SDS2000X

Plus, we can confirm there is bus contention happening by enabling the persistence display, as shown in the figure below:



In this case, the zone trigger is a quick and simple way to capture the interesting waveform. Enable the zone trigger, and draw a box to intersect with the bus contention part, as shown in the figure below:

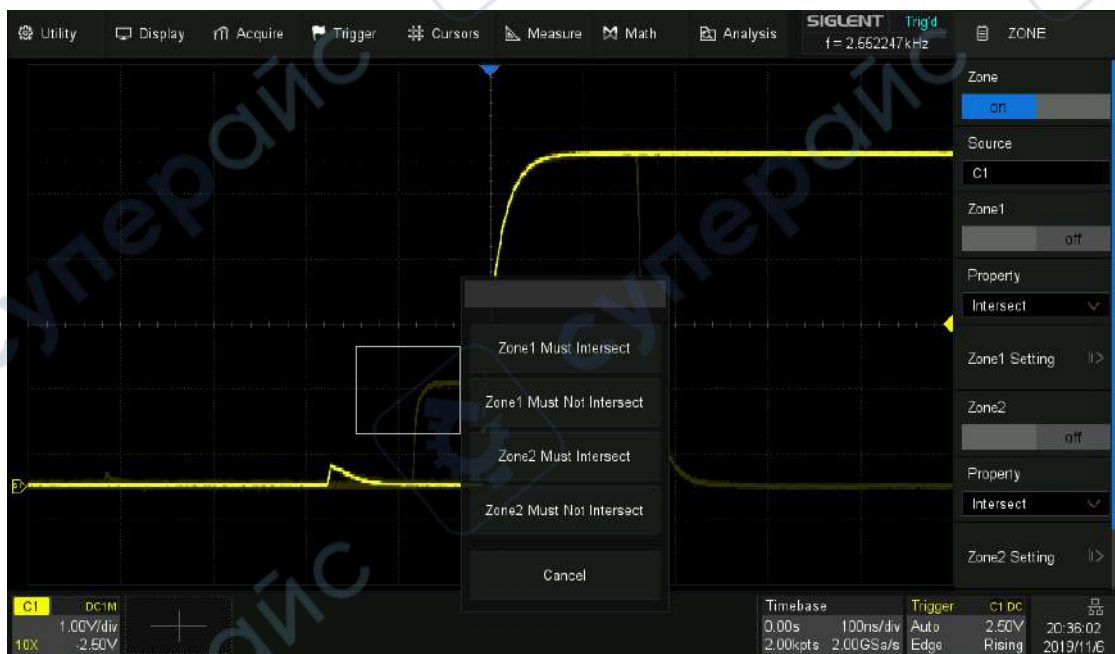

Now, we can accurately capture the exact bus contention waveform:



16 Serial Trigger and Decode

16.1 Overview

The SDS2000X Plus supports serial bus triggering and decoding on the following serial bus protocols: I2C, SPI, UART, CAN, LIN, and also support optional FlexRay, CAN FD, I2S, MIL-STD-1553B, SENT and Manchester.

Press the **Setup** button on the front panel or touch the trigger descriptor box, and then select the *Type* as *Serial* in the trigger dialog box to set the serial trigger:

- A. Select the type as *Serial*
- B. Select the serial bus protocol
- C. Set the signal, including the mapping relation between channels and bus signals, and the thresholds
- D. Trigger setting

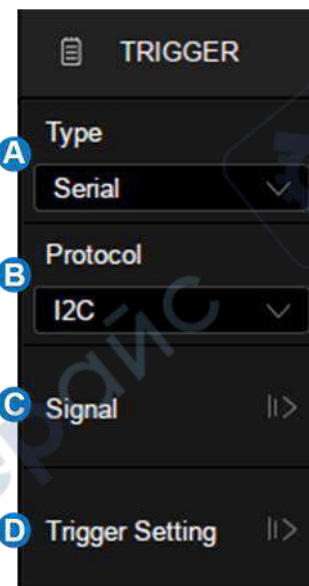

Press the **Decode** button or touch the *Analysis>Decode* to turn on the serial decode dialog box:

- A. Set the list of decode result
- B. Select the bus to set, Bus1 and Bus2
- C. Turn on/off the bus
- D. Set the bus display
- E. Select the serial bus protocol
- F. Touch to set the signal, including the mapping relation between channels and bus signals, and the thresholds. This is similar with the signal setting of serial trigger.
- G. Configure the bus protocol
- H. Synchronize the settings between serial trigger and decode

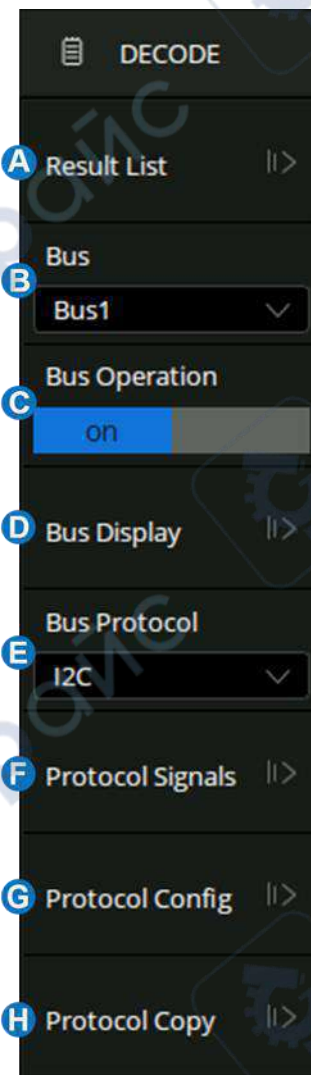

Below are detailed descriptions of the trigger and decoding steps for each protocol.

- I2C Trigger and Serial Decode
- SPI Trigger and Serial Decode
- UART Trigger and Serial Decode
- CAN Trigger and Serial Decode
- LIN Trigger and Serial Decode
- FlexRay Trigger and Serial Decode
- CAN FD Trigger and Serial Decode

- I2S Trigger and Serial Decode
- MIL-STD-1553B Trigger and Serial Decode
- SENT Trigger and Serial Decode
- Manchester Serial Decode

16.2 I2C Trigger and Serial Decode

This section covers triggering and decoding I2C signals. Please read the following for more details: " I2C Signal Settings", " I2C Trigger" and " I2C Serial Decode".

16.2.1 I2C Signal Settings

Connect the serial data signal (SDA) and the serial clock signal (SCL) to the oscilloscope, set the mapping relation between channels and signals and then set the threshold level of each signal. The signal settings of decoding and triggering are independent. If you want to synchronize the settings between decode and trigger, please perform *Copy Setting* in the decode dialog box.

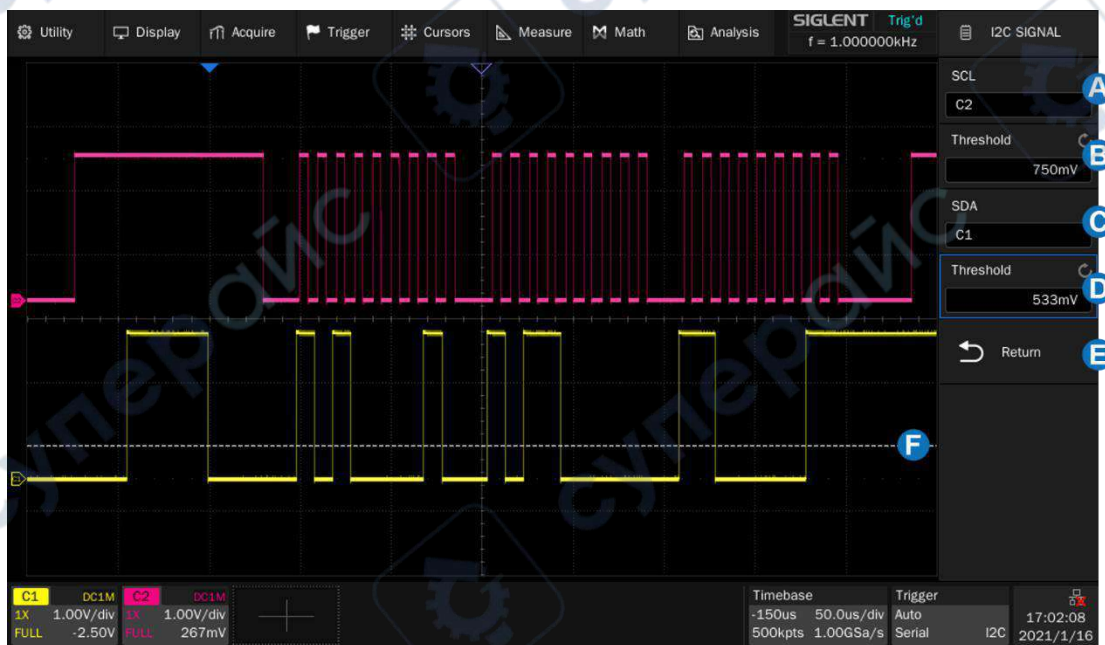

- Set the source of SCL. In the example above, SCL is connected to C4.
- Set the threshold level of SCL. It is 1.7V for the LVTTTL signal in this example.

- C. Set the source of SDA. In the example above, SDA is connected to C1.
- D. Set the threshold level of the SDA channel.
- E. Return to the previous menu.
- F. Threshold level line. It only appears when adjusting the threshold level.

Copy Setting

Touch the *Protocol Copy* in the decode dialog box to synchronize the settings between the trigger and decoding configurations.

- A. Copy the decode settings to trigger
- B. Copy the trigger settings to decode
- C. Return to the previous menu.

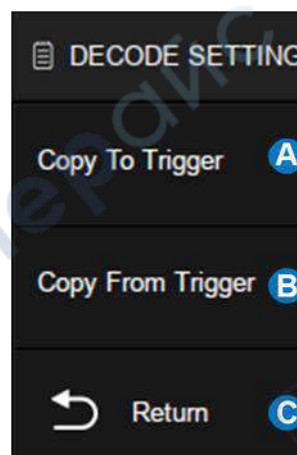

Note: The synchronization is not automatic. If the settings at one place change, a copy operation is necessary to re-synchronize.

16.2.2 I2C Trigger

When the protocol is set to I2C, the following trigger conditions can be set: Start, Stop, Restart, No Ack, EEPROM, or an R/W frame with specific device address and data value.

Touch **Trigger Setting** in the I2C trigger dialog box to select the trigger condition:

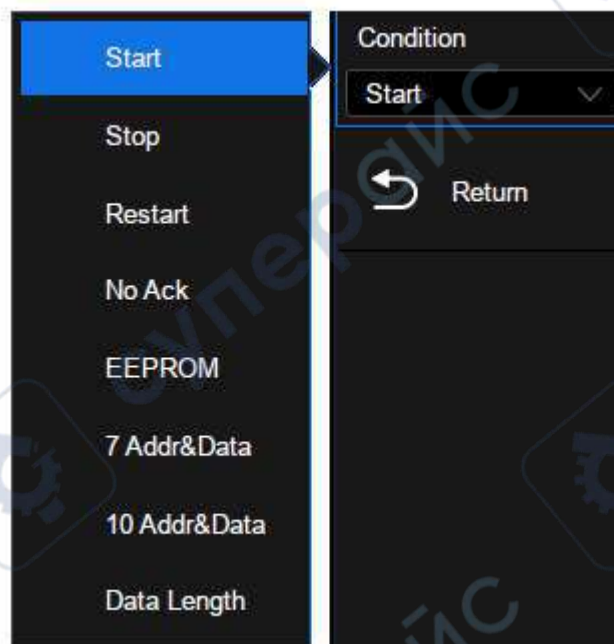

Start — The oscilloscope will be triggered when the SDA line transitions from high to low while the SCL is high.

Stop — The oscilloscope will be triggered when the SDA line transitions from low to high while the SCL is high.

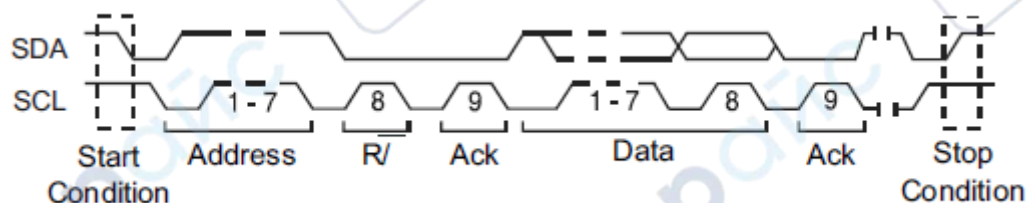

Restart — The oscilloscope will be triggered when another “Start” occurs before a “Stop”.

No Ack — The oscilloscope will be triggered when the SDA line is high during any SCL’ s ACK bit.

EEPROM — The trigger searches for EEPROM control byte value 1010xxx on the SDA bus. And there is a Read bit and an ACK bit behind EEPROM. Set the data value and compare type according to *Data1* and *Limit Range*. If EEPROM's data is greater than (less than, equal to) *Data1*, the oscilloscope will be triggered at the edge of ACK bit behind Data byte. It's unnecessary that the Data byte must follow the EEPROM.

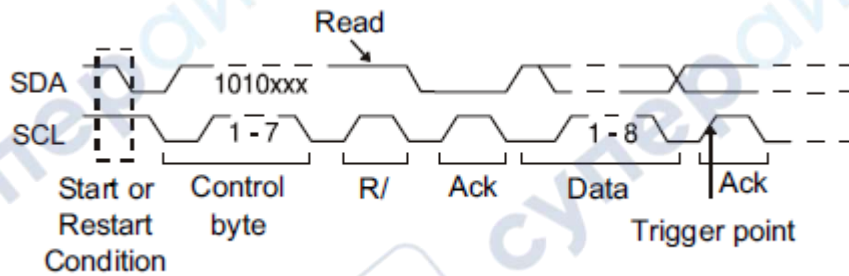
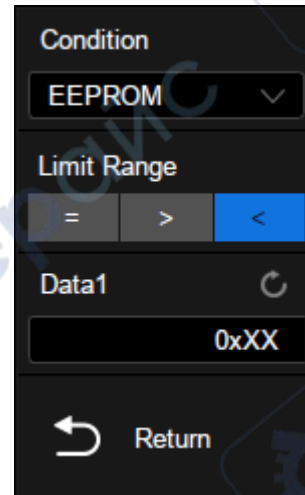

7 Address & Data — the oscilloscope will be triggered on read or write frame in 7-bit address mode.

Frame (Start: 7-bit address: R/W: Ack) — Data1 and Data2 are set to “0xXX”. If all bits match, then trigger on the Ack bit followed by the R/W bit.

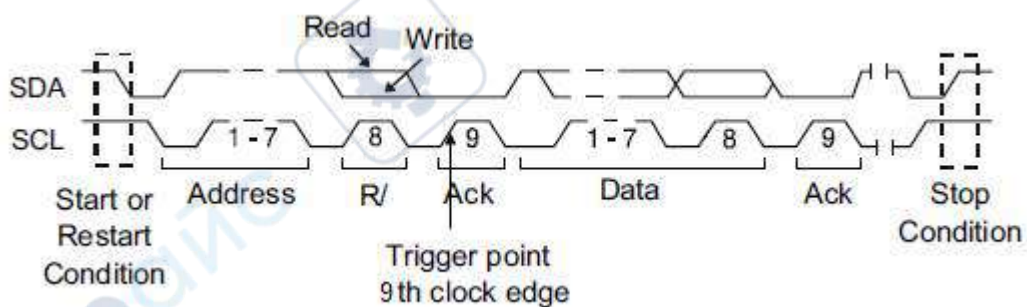

Frame (Start: 7-bit address: R/W: Ack: Data: Ack: Data2)—If all bits match, then trigger on the Ack bit followed by the Data2.

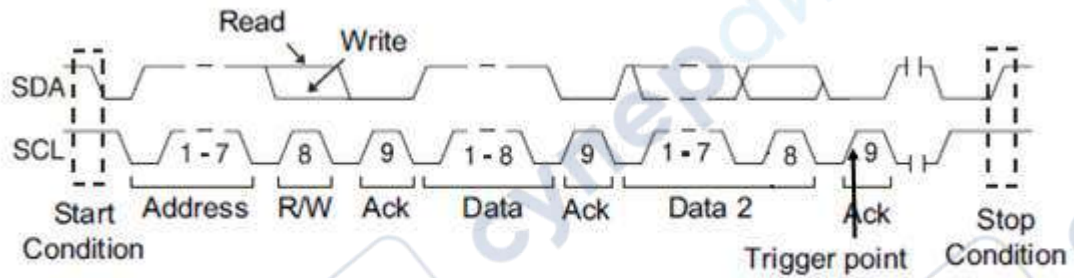

10 Address & Data — If all bits match, then trigger on the Ack bit followed by the Data.

Frame (Start: Address 1st byte: R/W: Ack: Address 2nd byte: Ack: Data)

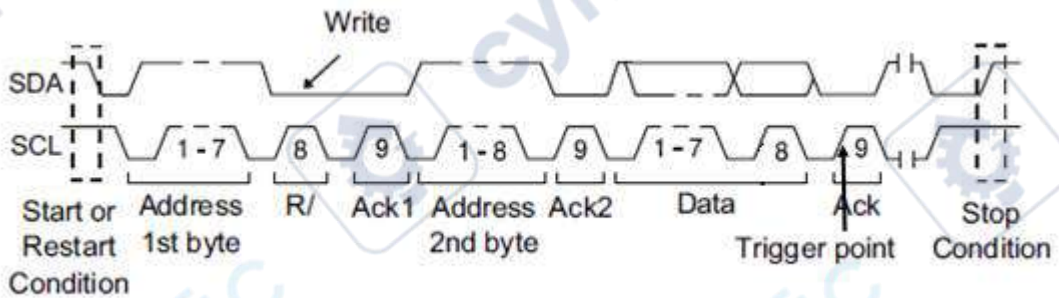

If you set the trigger condition to 7 address & data or 10 address & data:

- **Address** can be selected in the hexadecimal range of 0x00 to 0x7F (7-bit) or 0x3FF (10-bit). If the address is selected as "0xXX (7-bit address)" or "0xxx (10-bit address)", the address is ignored. It will always trigger on the Ack bit followed by the address.
- **Data1** and **Data2** can be selected in the hexadecimal range of 0x00 to 0xFF. If the data is selected as "0xXX", the data is ignored. It will always trigger on the Ack bit followed by the address.
- **R/W Bit** can be specified as Write, Read or Don't Care.

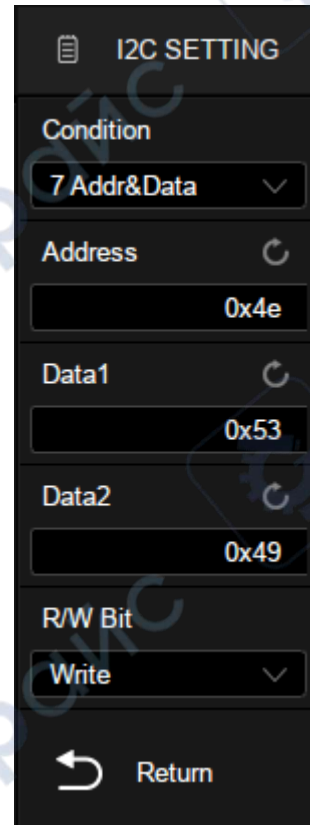

Data Length — The data length range is 1 to 12 bytes. When the SDA data length is equal to the value of the Data Length setting and the address length is the same as the set value, the oscilloscope will be triggered.

- Touch the **Address Length** to select "7-bits" or "10-bits" to match the address of the input signal.
- Touch the **Data Length** and turn the universal knob or by virtual keypad to set the data length to match the data length of the input signal.

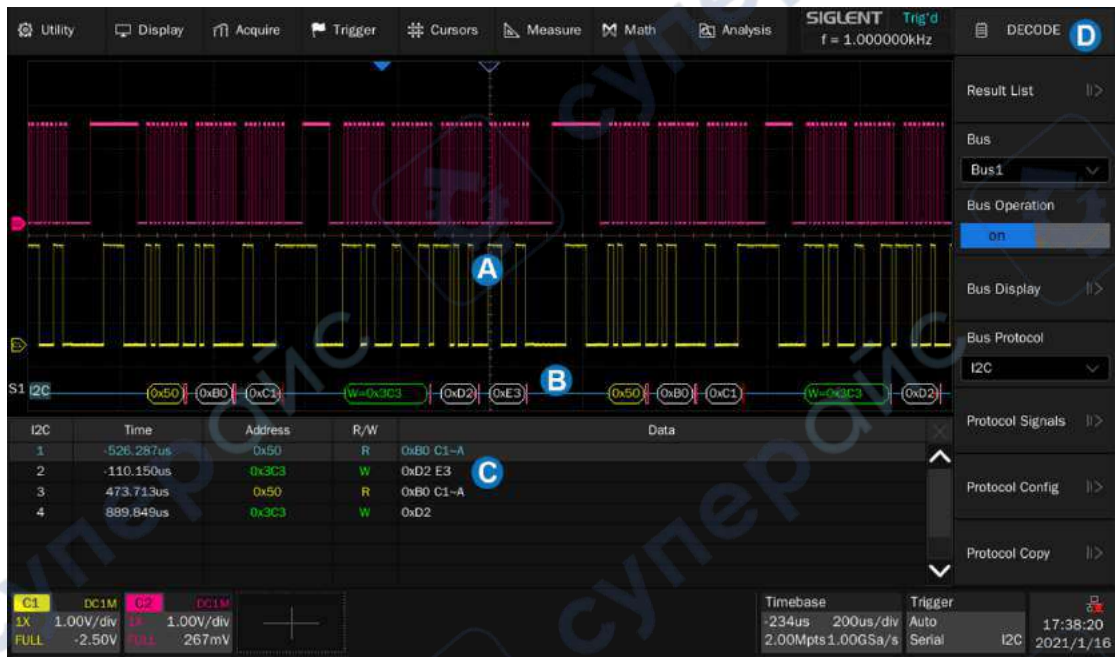

16.2.3 I2C Serial Decode

The layout of the touch screen display when I2C decoding is enabled is as follows:



- Waveform display area, shows the original waveforms of the bus signals
- Bus display, shows the decode result of the bus. At most two buses can be decoded at the same time. Touch *Bus Operation* of the dialog box to turn on or off selected bus, and touch *Bus Display* to select the display type of decode result (Binary, Decimal, Hex or ASCII) and set the bus location on the display
- List display area. The decoding results of multiple frames can be displayed in the list, in which each row shows the time label and decode result of a frame. Touch *Result List* to set the parameters of the list.
- Decode dialog box

Bus

- The address value is displayed at the beginning of a frame. The write address is displayed in green, and read address in yellow.
- W/R bit is represented by (W) and (R), followed by the address value.
- The  after a data or address byte represents ACK (acknowledgment), and  indicates no acknowledgment.
- The data value is displayed in white.
- A red point at the end of a segment indicates there is not enough space on the display to show the complete content of a frame, and some content is hidden, such as .

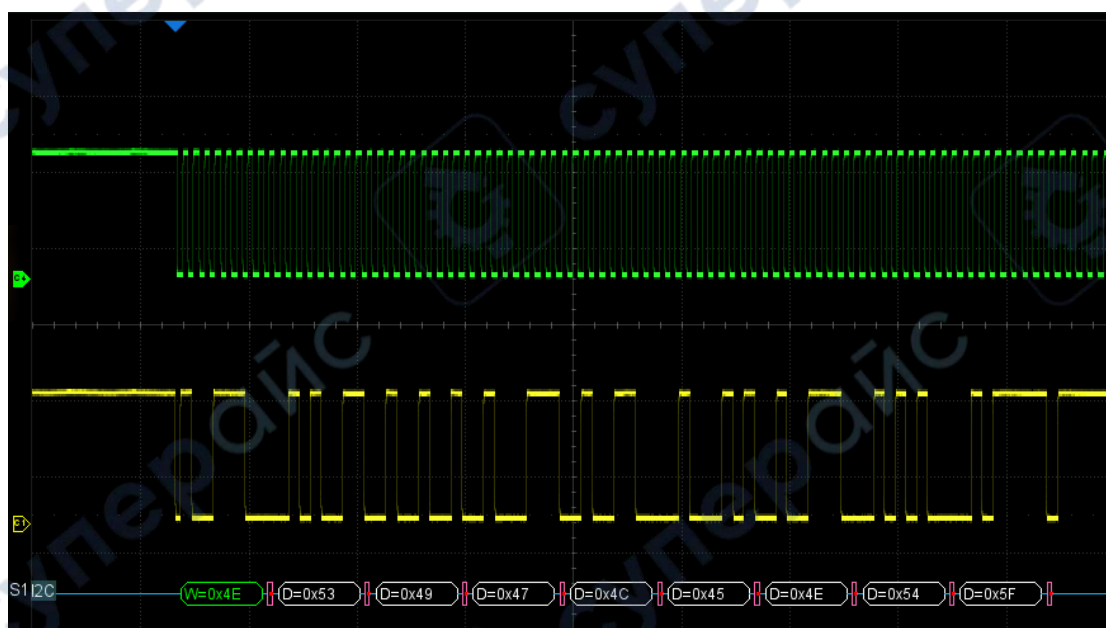

List

- TIME — The horizontal offset of the current data frame head relative to the trigger position.
- Address — Address value. For example, "0x2AB" means that address = 2AB with acknowledgement.

- R/W — Read address or write address.
- DATA — Data bytes.

I2C	Time	Address	R/W	Data
1	2.01300us	0x2AB	W	
2	192.003us	0x2AB	R	0x4E 54 5F 80 00 58 D8-A

Configuration

There is only one item *Include R/W Bit* in the configuration of the I2C decode. When it is disabled, the address is represented separately from the R/W bit, and when it is enabled, the R/W bit is represented together with the address.

For example, the address 0x4E: Write: Ack, is displayed as "0x4E (W)" when the R/W bit is not included and is displayed as "0x9C" when the R/W bit is included.

16.3 SPI Trigger and Serial Decode

This section covers triggering and decoding SPI signals. Please read the following for more details: " SPI Signal Settings", " SPI Trigger" and " SPI Serial Decode".

16.3.1 SPI Signal Settings

Connect the CLK, MOSI, MISO and CS signals to the oscilloscope and set the mapping relation between channels and signals. Then set the threshold level of each signal. The process of specifying the source and threshold is similar to " I2C Signal Settings".

CLK

In addition to specifying the source and the threshold level, for the CLK signal, it is also necessary to specify the *Edge Select*.

- Rising - Data latched on the rising edge of the clock.
- Falling - Data latched on the falling edge of the clock.

The user can select the edge according to the actual phase relationship between the clock and data of the SPI bus. Referring to the following figure, when the falling edge of the clock is aligned with the data, the rising edge is selected to latch the data. When the rising edge of the clock is aligned with the data, the falling edge is selected to latch the data.

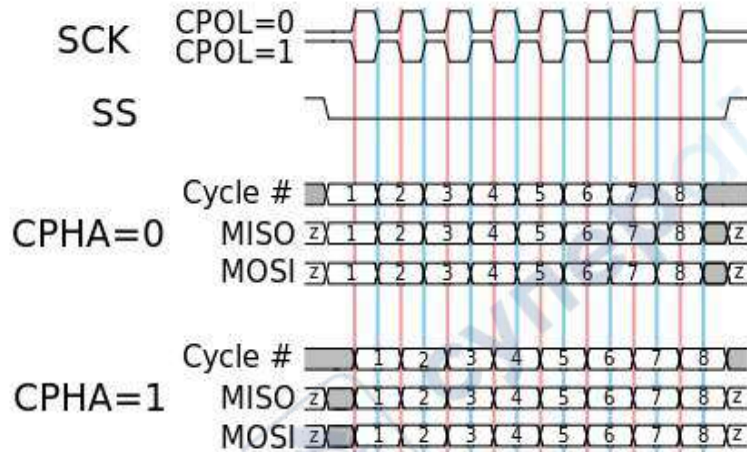

CS

The CS signal should be set to correct *CS Type*, including CS, \sim CS, and Clock Timeout.

- CS - Active high. The CS signal needs a complete rising edge on the screen to be regarded as active.
- \sim CS - Active low. The \sim CS signal needs a complete falling edge on the screen to be regarded as active.
- Clock Timeout - It is not necessary to specify the source and the threshold level for the CS signal. The only parameter for the CS signal is the timeout Limit, which is the minimum time that the clock signal must be held idle for before the oscilloscope acquires valid data. This setting is suitable for the case where the CS signal is not connected, or the number of oscilloscope channels is insufficient (such as two-channel oscilloscopes).

The method of copying settings is the same as I2C signal settings. See "I2C Signal Settings" for details.

Example:

Connect the data, CLK and \sim CS signals of an SPI bus respectively to C1, C2 and C3. Data width = 8-bit, Bit order = MSB, CS polarity = active low, and 12 data bytes are transmitted in one frame.

In the SPI trigger signal menu, set the source and threshold of CLK, MISO and CS signals, then copy the trigger settings to decoding. Adjust the timebase, so that there is a falling edge on the CS signal shown in the screen:



When the CS type is set to Clock Timeout, turn on Cursor, measure the clock idle time between frames as 830 μ s, and measure the interval between clock pulses as 0.78 μ s, then set the timeout to a value between 0.78 and 830 μ s. In this example it is set to 1 μ s:



If the data width is set to be greater than 8-bits (such as 16-bits), measure the clock idle time between 8-bit data packets as $3.14 \mu\text{s}$, and then set the timeout time to a value between 3.14 and $830 \mu\text{s}$. In this example, it is set to $5 \mu\text{s}$:



16.3.2 SPI Trigger

The trigger condition for the SPI trigger is mainly about data. Touch *Trigger Setting* in the dialog box to set data:

- A. Trigger Type: MISO or MOSI
- B. Position Type: Any or Value
- C. Data Length: 4~96 bits
- D. Set to trigger on the specified data value. Touch *Data Value* twice, and enter the value by the virtual keypad, or touch *All Same* to set all bits to 0, 1 or ignored ("X")
- E. Set the bit order to MSB or LSB
- F. Return to previous menu

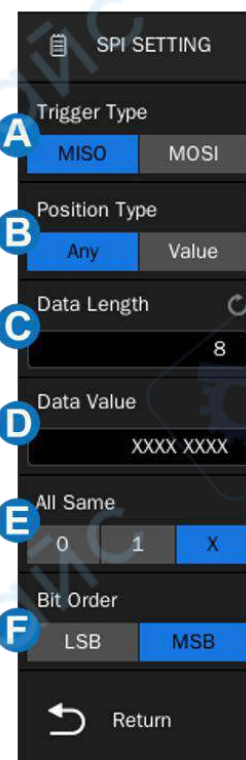

16.3.3 SPI Serial Decode

The configuration of SPI decoding is similar to I2C.

In the *Bus Config* menu, Data Length (4-32 bit) and Bit Order (LSB or MSB) are configurable.

16.4 UART Trigger and Serial Decode

This section covers triggering and decoding UART signals. Please read the following for more details: "UART Signal Settings", "UART Trigger" and "UART Serial Decode".

16.4.1 UART Signal Settings

Connect the RX and TX signals to the oscilloscope, set the mapping relation between channels and signals, and then set the threshold level of each signal. The process of specifying the source and threshold is similar to "I2C Signal Settings".

In the *BusConfig* menu of trigger or decode, the following parameters are available:

- A. Touch to select the baud rate: 600, 1200, 2400, 4800, 9600, 19200, 38400, 57600, 115200 b/s or Custom
- B. Data Length: 5~8 bit
- C. Parity Check: None, Odd, Even, Mark or Space. If the data is 9 bits, the 9th bit is treated as Mark parity or Space parity
- D. Select the number of stop bits
- E. Set the idle level
- F. Set the bit order
- G. Return to previous menu

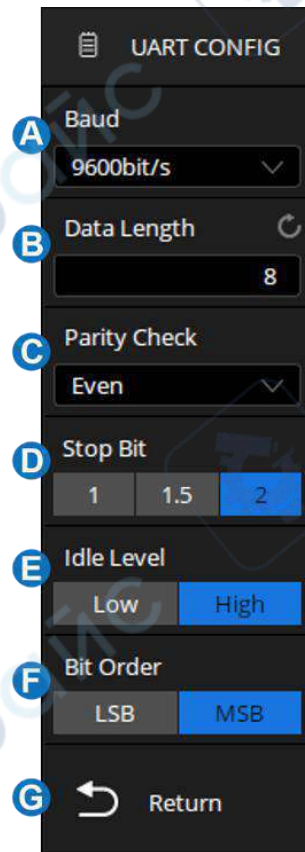

The method of copying settings is the same as I2C signal settings. See "I2C Signal Settings" for details.

16.4.2 UART Trigger

Touch *Trigger Setting* in the dialog box to set the trigger condition:

- A. Source Type: RX or TX
- B. Trigger Condition: Start, Stop, Data or Error
- C. When the "trigger condition" is Data, set the compare type to: =, >, <
- D. When the "trigger condition" is Data, set the data value
- E. Return to previous menu

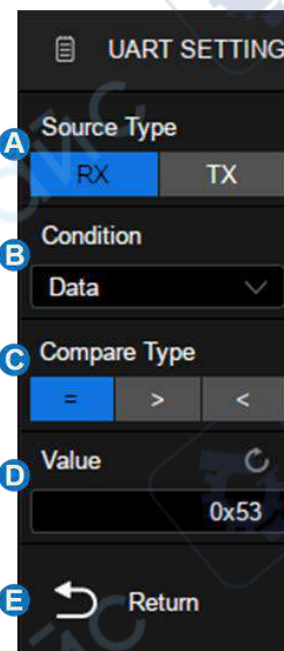

Trigger Condition

- **Start** — The oscilloscope triggers when the start bit appears on the RX/TX.
- **Stop** — The oscilloscope triggers when the stop bits appear on the RX/TX. It always triggers on the first stop bit.
- **Data** — Trigger on data
 - ✓ Touch *Compare Type* to select "=", ">" or "<".
 - ✓ Touch *Value* to set the data value by the universal knob or virtual keypad. The range of data value is 0x00 to 0xff.
- **Error** — The oscilloscope performs parity check on the data according to the parity type set by the user, and triggers if the check value is incorrect.

16.4.3 UART Serial Decode

The configuration of UART decoding is similar to that of I2C decoding.

16.5 CAN Trigger and Serial Decode

This section covers triggering and decoding CAN signals. Please read the following for more details: "CAN Signal Settings", "CAN Trigger" and "CAN Serial Decode".

16.5.1 CAN Signal Settings

Connect the CAN_H and CAN_L signals to the oscilloscope, set the mapping relation between channels and signals, and then set the threshold level of each signal. The process of specifying the source and threshold is similar to "I2C Signal Settings".

In *BusConfig* menu of trigger and decode, baud rate can be set to: 5 kb/s, 10 kb/s, 20 kb/s, 50 kb/s, 100 kb/s, 125 kb/s, 250 kb/s, 500 kb/s, 800 kb/s, 1 Mb/s or Custom.

The method of copying settings is the same as I2C signal settings. See "I2C Signal Settings" for details.

16.5.2 CAN Trigger

Touch *Trigger Setting* in the CAN trigger dialog box to set the trigger condition:

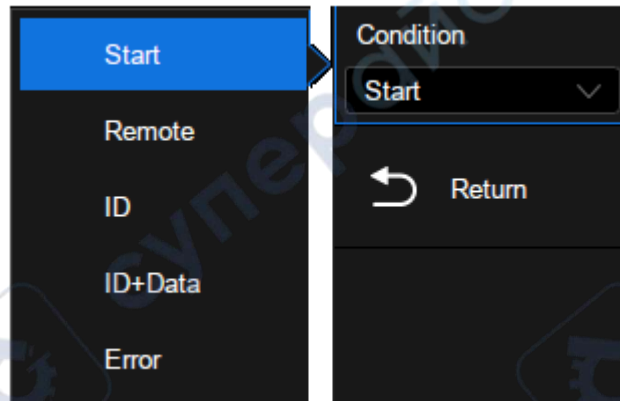

- **Start** —The oscilloscope triggers at the beginning of the frame.
- **Remote** — The oscilloscope triggers on a remote frame with a specified ID. ID, ID Bits (11-bit or 29-bit) and Curr ID Byte (1st, 2nd, 3rd, or 4th byte) can be set. Curr ID Byte is used to specify the byte to be adjusted when using the universal knob.
- **ID** —The oscilloscope triggers on the data frame that matches the specified ID. ID, ID Bits (11-bit or 29-bit), and Curr ID Byte (1st, 2nd, 3rd, or 4th byte) can be set.
- **ID + Data** —The oscilloscope triggers on the data frame that matches the specified ID and data. ID, ID Bits (11-bit or 29-bit), Curr ID Byte (1st, 2nd, 3rd, or 4th byte), Data1 and Data2 can be set.
- **Error**—The oscilloscope triggers on the error frame.

16.5.3 CAN Serial Decode

The configuration of CAN decoding is similar to that of I2C decoding.

On the bus:

- ID is displayed in green.
- LEN (data length) is displayed in light yellow.
- DATA is displayed in white.
- CRC is displayed in blue.
- The red point at the end of a segment indicates there is not enough space on the display to show the complete content of a frame and some content is hidden.

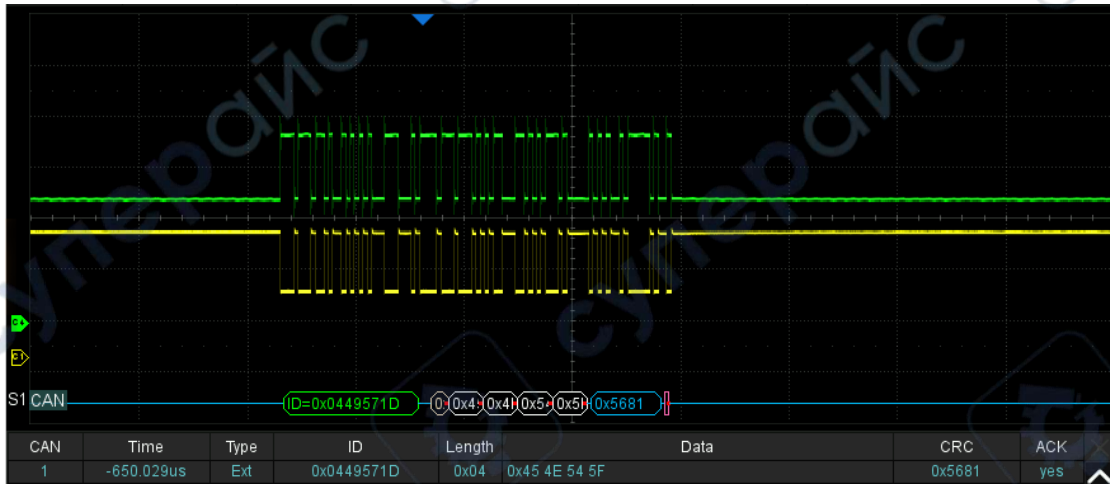

In the list view:

- Time — The horizontal offset of the current data frame head relative to the trigger position.
- Type — Type of the frame. The data frame is represented by “D” and the remote frame is represented by “R”.
- ID — ID of the frame, 11-bits or 29-bits ID are automatically detected.
- Length — Data length.
- Data — Data values.

- CRC — Cycle redundancy check.
- Ack — Acknowledge bit.

CAN	Time	Type	ID	Length	Data	CRC	ACK
1	-24.1488ms	R	0x012F30DC	0		0x4BA5	yes
2	-19.9490ms	D	0x0449571D	4	0x45 4E 54 5F	0x5681	yes
3	-15.1293ms	R	0x056A7E0C	3		0x734E	yes
4	-10.9295ms	D	0x07819F51	8	0x53 49 47 4C 45 4E 54 5F	0x0C9B	yes
5	-5.44975ms	R	0x012F30DC	0		0x4BA5	yes
6	-1.24996ms	D	0x0449571D	4	0x45 4E 54 5F	0x5681	yes
7	3.56980ms	R	0x056A7E0C	3		0x734E	yes

16.6 LIN Trigger and Serial Decode

This section covers triggering and decoding LIN signals. Please read the following for more details: “LIN Signal Settings”, “LIN Trigger” and “LIN Serial Decode”.

16.6.1 LIN Signal Settings

Connect the LIN signal to the oscilloscope, and then set the threshold level of the signal. The process of specifying the source and threshold is similar to “I2C Signal Settings”.

In *BusConfig* menu of trigger and decode, baud rate can be set to: 600 b/s, 1200 b/s, 2400 b/s, 4800 b/s, 9600 b/s, 19200 b/s or Custom.

The method of copying settings is the same as I2C signal settings. See “I2C Signal Settings” for details.

16.6.2 LIN Trigger

Touch *Trigger Setting* in the LIN trigger dialog box to set the trigger conditions:

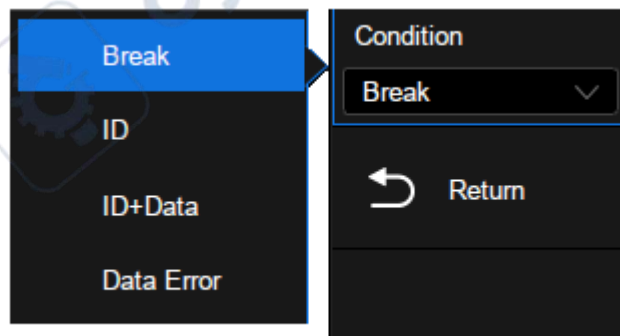

- **Break** —The oscilloscope triggers at the beginning of the frame.
- **ID** —The oscilloscope triggers on the frame that matches the specified ID, which ranges from 0x00 to 0x3f.
- **ID & Data**—The oscilloscope triggers on the frame that matches the specified ID and data. ID, Data1, and Data2 can be set.
- **Data Error** —The oscilloscope will trigger when a data error happens.

16.6.3 LIN Serial Decode

The configuration of LIN decoding is similar to that of I2C decoding.

On the bus:

- ID is displayed in green
- LEN (data length) and CHK are displayed in blue
- DATA is displayed in white.

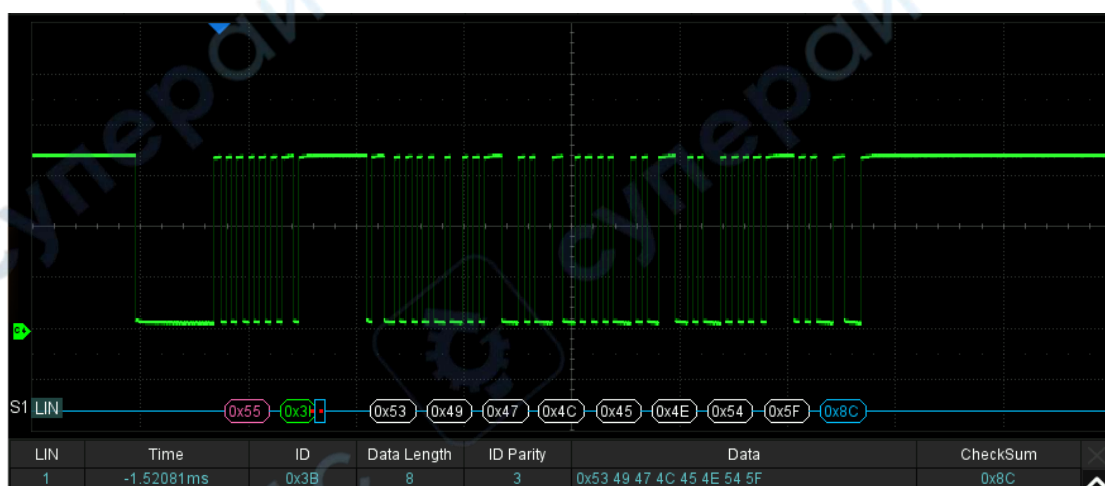

In the list view:

- Time — The horizontal offset of the current data frame head relative to the trigger position.
- ID — ID of the frame.
- Data length — Data length.
- ID Parity — ID parity check.
- Data — Data values.
- Checksum — Data checksum.

LIN	Time	ID	Data Length	ID Parity	Data	Checksum
1	-39.8835ms	25H	4	00H	ENT_	93H
2	-3.63532ms	3BH	8	03H	SIGLENT_	8CH
3	36.7793ms	06H	2	00H	T_	46H
4	70.9443ms	14H	2	00H	T_	38H
5	105.109ms	25H	4	00H	ENT_	93H

16.7 FlexRay Trigger and Serial Decode

This section covers triggering and decoding FlexRay signals. Please read the following for more details: " FlexRay Signal Settings", " FlexRay Trigger" and " FlexRay Serial Decode".

16.7.1 FlexRay Signal Settings

Connect the FlexRay signal to the oscilloscope, and then set the threshold level of the signal. The process of specifying the source and threshold is similar to " I2C Signal Settings".

In the *BusConfig* menu of the trigger and decoding section, the baud rate can be set to 2.5 Mb/s, 5.0 Mb/s, 10.0 Mb/s or Custom.

The method of copying settings is the same as I2C signal settings. See " I2C Signal Settings" for details.

16.7.2 FlexRay Trigger

Touch *Trigger Setting* in the FlexRay trigger dialog box to set the trigger conditions:



- TSS— The oscilloscope triggers on the transmission start sequence.

- **Frame**— The oscilloscope triggers on the frame.
 - ✓ Set Frame header indicators: Payload preamble indicator, null frame indicator, sync frame indicator, startup frame indicator.
 - ✓ Touch *ID* to set the frame ID by the universal knob or virtual keypad. The range of ID is 0x000 to 0x7ff.
 - ✓ Touch *Compare Type* to select "=", ">" or "<". When setting the *Compare Type* as "=", the repetition factor is also required.
 - ✓ Touch *Cycle* to set the cycle count by the universal knob or virtual keypad. The range of data value is 0 to 63.
- **Symbol**— The oscilloscope triggers on CAS/MTS (Conflict Avoidance Symbol/ Media access Test Symbol) or WUS (Wake-up Symbol)
- **Errors**— The oscilloscope will trigger when a data error happens, including errors on FSS, BSS, FES, Header CRC, and Frame CRC.

16.7.3 FlexRay Serial Decode

The configuration of FlexRay decoding is similar to that of I2C decoding.

On the bus:

- The signatures (CAS/MTS, WUP) are displayed in yellow-green.
- TSS transmission start sequence, displayed in yellow-green.
The null frame indicator, the Sync frame indicator, and the Startup frame indicator are displayed in the frame and displayed in pink.
- The ID is displayed in the frame and is displayed in green.

- PL (Valid Data Length) is displayed in frames, in words, in light yellow.
- HCRC (Head Check Code) is displayed in the frame and displayed in blue.
- CYC (cycle) is displayed in the frame and displayed in light yellow.
- D (data) is displayed in the frame and displayed in white.
- FCRC (Data Check Code) is displayed in the frame and displayed in blue.



In the list view:

- Time— The horizontal offset of the current data frame head relative to the trigger position.
- FID— Frame ID, symbol occupies a single line of the list.
- PL— Valid Data Length
- HCRC— Head Check Code
- CYC— Cycle count
- Data— Data values

- FCRC— Data Check Code

FLX	Time	FID	PL	HCRC	CYC	Data	FCRC
1	-83.0406us	0x012	0x02	0x776	0x0C	0xEE 0x23 0x8C 0x7E	0x90E786
2	-25.0160us	CAS/MTS					
3	-1.40820us	0x012	0x02	0x776	0x0C	0xEE 0x23 0x8C 0x7E	0x90E786
4	56.6174us	CAS/MTS					
5	80.2240us	0x012	0x02	0x776			

16.8 CAN FD Trigger and Serial Decode

This section covers triggering and decoding CAN FD signals. Please read the following for more details: "CAN FD Signal Settings", "CAN FD Trigger" and "CAN FD Serial Decode".

16.8.1 CAN FD Signal Settings

Connect the CAN FD signal to the oscilloscope, and then set the threshold level of the signal. The process of specifying the source and threshold is similar to "I2C Signal Settings".

In *BusConfig* menu of trigger and decode, the nominal baud rate can be set to: 10 kb/s, 25 kb/s, 50 kb/s, 100 kb/s, 250 kb/s, 1 Mb/s or Custom. The data baud rate can be set to: 500 kb/s, 1 Mb/s, 2 Mb/s, 5 Mb/s, 8 Mb/s, 10 Mb/s or Custom.

The method of copying settings is the same as I2C signal settings. See "I2C Signal Settings" for details.

16.8.2 CAN FD Trigger

Touch *Trigger Setting* in the CAN FD trigger dialog box to set the trigger conditions:

- A. Frame Type: Both, CAN, CAN FD
- B. When the "Frame Type" is CAN FD, turn on or off ISO
- C. When the "Frame Type" is CAN FD, set the BRS (Bit Rate Switch) to Both, Normal or FD
- D. Trigger Condition: Start, Remote, ID, ID + Data, Error
- E. Return to previous menu

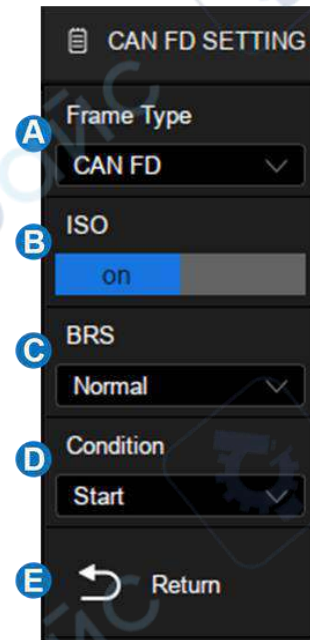

Trigger Condition

- **Start**— The oscilloscope triggers at the beginning of the frame.
- **Remote**— The oscilloscope triggers on a remote frame with a specified ID. ID, ID Bits (11-bit or 29-bit) and Curr ID Byte (1st, 2nd, 3rd, or 4th byte) can be set. Curr ID Byte is used to specify the byte to be adjusted when using the universal knob.
- **ID**— The oscilloscope triggers on the data frame that matches the specified ID. ID, ID Bits (11-bit or 29-bit), and Curr ID Byte (1st, 2nd, 3rd, or 4th byte) can be set.
- **ID + Data**— The oscilloscope triggers on the data frame that matches the specified ID and data. ID, ID Bits (11-bit or 29-bit), Curr ID Byte (1st, 2nd, 3rd, or 4th byte), Data1 and Data2 can be set.
- **Error**— The oscilloscope triggers on the error frame.
 - ✓ Error Frame
 - ✓ Stuff Bit Error

- ✓ CRC Mismatch Error: The oscilloscope triggers when the calculated CRC does not match the transmitted CRC.
- ✓ Stuff Bit Cnt Err: Effective only when ISO is turned on, the oscilloscope triggers when the stuff bit count is incorrect.
- ✓ Stuff Bit Cnt Par. Err: Effective only when ISO is turned on, the oscilloscope triggers when the polarity of the stuff bit count is incorrect.

16.8.3 CAN FD Serial Decode

The configuration of CAN FD decoding is similar to that of I2C decoding.

On the bus:

- ID is displayed in green.
- BRS (Bit Rate Switch) is displayed in light yellow.
- ESI (Error State Indicator) is displayed in blue.
- L (Data Length) is displayed in light yellow.
- D (Data) is displayed in white.
- CRC is displayed in blue.
- Ack is displayed in pink.
- The red point at the end of a segment indicates there is not enough space on the display to show the complete content of a frame and some content is hidden.

In the list view:

- Time— The horizontal offset of the current data frame head relative to the trigger position.
- Type— Type of the frame. Standard CAN frame is represented by "Std", CAN FD frame is represented by "FD", the extended frame is represented by "Ext" and the remote frame is represented by "RTR".
- ID— Frame ID.
- Length— Data length.
- Data— Data bytes.
- CRC— Cycle redundancy check.
- Ack— Acknowledge bit.

CAN FD	Time	Type	ID	Length	Data	CRC	ACK
1	-190.506us	FD Std	0x66	0x08	0x0A 1B 2C 3D 4E 5F 60 71	0x9ADA	yes
2	-95.5054us	FD Std	0x66	0x08	0x0A 1B 2C 3D 4E 5F 60 71	0x9ADA	yes
3	-505.600ns	FD Std	0x66	0x08	0x0A 1B 2C 3D 4E 5F 60 71	0x9ADA	yes
4	94.4942us	FD Std	0x66	0x08	0x0A 1B 2C 3D 4E 5F 60 71	0x9ADA	yes
5	189.496us	FD Std	0x66	0x08	0x0A 1B 2C 3D 4E 5F 60 71	0x9ADA	yes

16.9 I2S Trigger and Serial Decode

This section covers triggering and decoding I2S signals. Please read the following for more details: " I2S Signal Settings", " I2S Trigger" and " I2S Serial Decode".

16.9.1 I2S Signal Settings

Connect the WS, BCLK, and Data signals to the oscilloscope set the mapping relation between channels and signals, and then set the threshold level of each signal. The process of specifying the source and threshold is similar to " I2C Signal Settings"

BCLK

In addition to specifying the source and the threshold level, BCLK signals also require the specification of the *Edge Select*.

- Rising - Data latched on the rising edge of the clock.
- Falling - Data latched on the falling edge of the clock.

WS

In addition to specifying the source and the threshold level, WS signals also require the specification of the *Left CH*.

- Low - Select left channel when WS is low and right channel when WS is high.
- High - Select the right channel when WS is low and left channel when WS is high.

The method of copying settings is the same as I2C signal settings. See "I2C Signal Settings" for details.

16.9.2 I2S Trigger

Touch *Trigger Setting* in the I2S trigger dialog box to set the trigger conditions:

- A. Audio Variant: Audio-I2S, Audio-LJ, Audio-RJ
- B. Trigger Condition: Data, Mute, Clip, Glitch, Rising Edge, Falling Edge
- C. Channel: Set the channel to trigger, Left or Right
- D. Set the bit order to MSB or LSB
- E. Start Bit: The start bit of data, range from 0 to 31
- F. Data Bits: Specify the number of bits per channel, range from 1 to 32 bits
- G. When the "Trigger Condition" is Data, set the compare type to: =, >, <
- H. When the "Trigger Condition" is Data, set the data value
- I. Return to previous menu

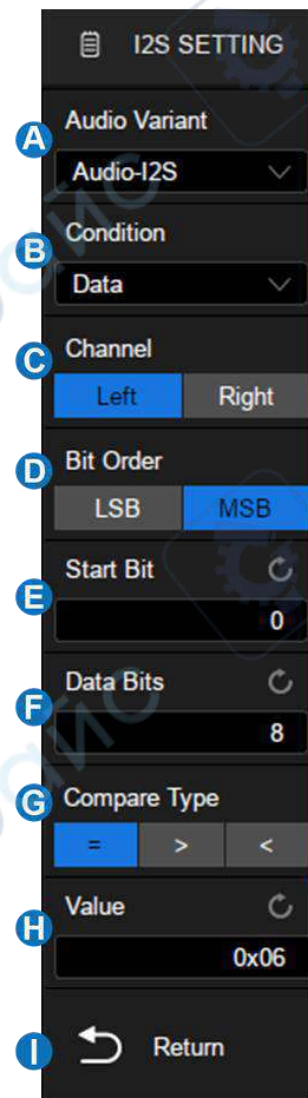

Trigger Condition

- **Data**— Trigger on data.
 - ✓ Touch *Compare Type* to select "=", ">" or "<".
 - ✓ Touch *Value* to set the data value by the universal knob or virtual keypad. The range of data value is related to the number of *Data Bits*.
- **Mute**— Trigger on the mute signal. Mute signal: Volume is less than the set value and duration reaches the set value.
 - ✓ Touch *MNF* to set the mute threshold by the universal knob or virtual keypad. The range of value is related to the number of *Data Bits*.
 - ✓ Touch *Duration* to set the value by the universal knob or virtual keypad. The range is 1-64 frames.
- **Clip**— Trigger on a clipped signal. Clip signal: Volume is greater than the set value and duration reaches the set value.
 - ✓ Touch *Clip Level* to set the clip threshold by the universal knob or virtual keypad. The range of value is related to the number of *Data Bits*.
 - ✓ Touch *Duration* to set the value by the universal knob or virtual keypad. The range is 1-64 frames.
- **Glitch**— Trigger on glitches within the audio signal.
 - ✓ Touch *Threshold* to set the threshold by the universal knob or virtual keypad. The range of value is related to the number of *Data Bits*.
- **Rising Edge**— Trigger on signals greater than the *Threshold* setting value.

- ✓ Touch *Threshold* to set the threshold by the universal knob or virtual keypad. The range of values is related to the number of *Data Bits*.
- **Falling Edge**— Trigger on signals less than the *Threshold* setting value.
 - ✓ Touch *Threshold* to set the threshold by the universal knob or virtual keypad. The range of value is related to the number of *Data Bits*.

16.9.3 I2S Serial Decode

The configuration of I2S decoding is similar to that of I2C decoding.

In the list view:

- Time— The horizontal offset of the current data frame head relative to the trigger position.
- Type— Channel type, the left channel is represented by "Left CH" and the right channel is represented by "Right CH".
- Data— Data bytes
- Error— Error

I2S	Time	Type	Data	Error
0	-600.034us	Right CH	0x01	
1	-100.006us	Left CH	0x03	
2	399.97us	Right CH	0x01	
3	899.996us	Left CH	0x01	

16.10 MIL-STD-1553B Trigger and Serial Decode

This section covers triggering and decoding MIL-Standard 1553B signals. Please read the following for more details: "MIL-STD-1553B Signal Settings" and "MIL-STD-1553B Serial Decode".

16.10.1 MIL-STD-1553B Signal Settings

Connect the MIL-STD-1553B signal to the oscilloscope, set the mapping relation between channels and signals, and then set the threshold level of each signal. The process of specifying the source and threshold is similar to "I2C Signal Settings"

16.10.2 MIL-STD-1553B Serial Decode

The configuration of MIL-STD-1553B decoding is similar to that of I2C decoding.

On the bus:

- C/S the Command/Status word is displayed in green.
- RTA the RT address is displayed in the frame and displayed in light yellow.
- C/S Data is displayed in the frame and is displayed in white.
- The data word is displayed in yellow and the data is displayed in the frame and displayed in white.
- Check Code is displayed in the frame and displayed in blue.

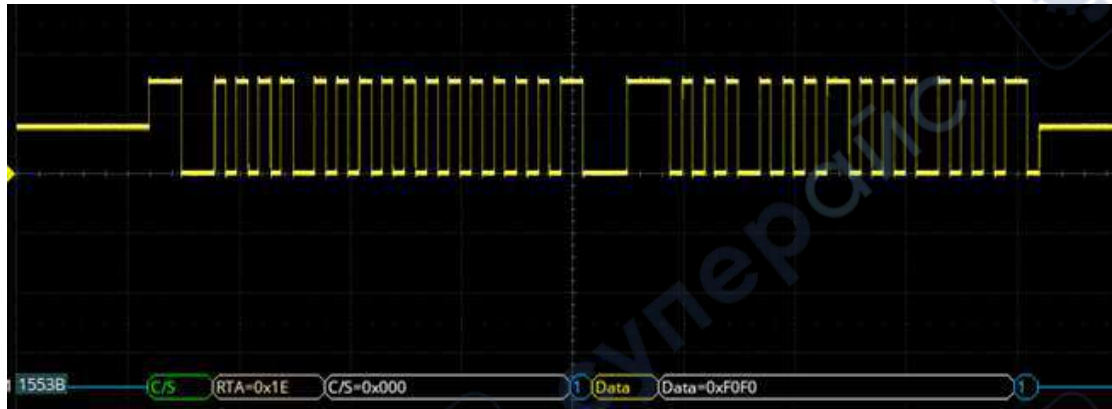

In the decoding list view:

- Time— The horizontal offset of the current data frame head relative to the trigger position.
- RTA— The RT address
- Type— Type of the word
- Data— Data values
- Error— Error type

1553B	Time	RTA	Type	Data	Error
1	-2.89040us	0x1	Cmd/Status	0x031	
2	27.0088us	0x1	Cmd/Status	0x0	Parity
3	47.0402us		Data	0x888	

16.11 SENT Trigger and Serial Decode

This section covers triggering and decoding SENT signals. Please read the following for more details: " SENT Signal Settings", " SENT Trigger" and " SENT Serial Decode".

16.11.1 SENT Signal Settings

Connect the SENT signal to the oscilloscope, set the mapping relation between channels and signals, and then set the threshold level of each signal. The process of specifying the source and threshold is similar to " I2C Signal Settings"

In the **BusConfig** menu of trigger or decode, the following parameters are available:

- A. Touch to specify the nominal clock period (tick) time
- B. Set the percent tolerance to determine whether the sync pulse is valid for decoding the data
- C. Set the number of nibbles in a Fast Channel Message
- D. Set the CRC format that will be used in calculating the correctness of the CRCs. The New CRC selection uses the 2010 CRC format. If "NEW" is not selected, the CRC will use the 2008 format. Enhanced

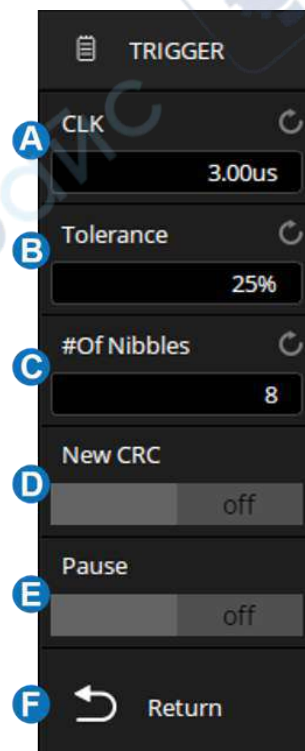

Serial Message CRCs are always calculated using the 2010 format, but for the Fast Channel Messages, and for Short Serial Message CRCs, the chosen setting is used

- E. Specify whether there is a pause pulse between Fast Channel Messages
- F. Return to previous menu

16.11.2 SENT Trigger

When the protocol is set to SENT, the following trigger conditions can be set: Start, Slow Channel, Fast Channel and Error.

Touch *Trigger Setting* in the SENT trigger dialog box to select the trigger condition:

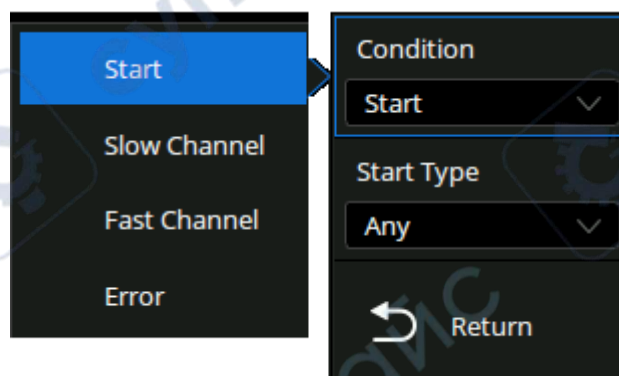

Start — the oscilloscope will be triggered on the start of message (after 56 synchronization ticks). You can select the type of the message: Fast Channel Message, Slow Channel Message or any.

Fast Channel — the oscilloscope will be triggered on a Fast Channel Message when the Status & Communication nibble and the data nibbles match the specified values.

- **State** can be selected in the hexadecimal range of 0x0 to 0xF. If the value is selected as "0xX", the state is ignored.
- **Compare Type** can be specified as Equal, Not Equal, Less than, Less or Equal, Greater than, Greater or Equal, in Range of, out of Range.
- **At Pos** determines the start position of the trigger data. If selected as Value, you need to set **Nibble Pos** in the decimal range of 0 to 5. If selected as Don't care, the oscilloscope will be triggered at the first data which matches the specified condition.
- **Nibble Len** can be selected in the decimal range of 1 to 6. It is associated with the **Nibble Pos**.
- **Data** can be selected in hex. The range is associated with the **Nibble Pos**. If the data is selected as "0xXX", the data is ignored.

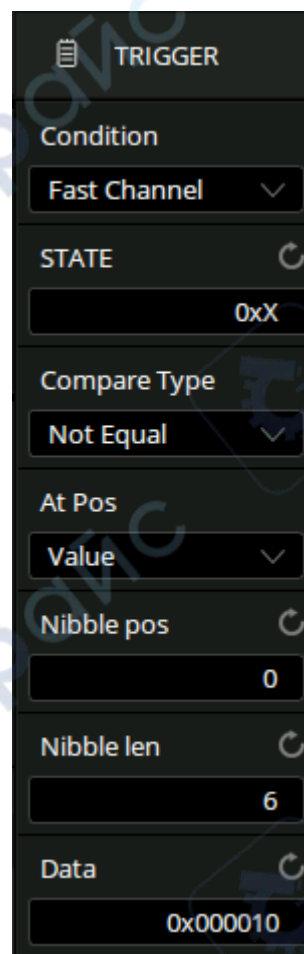

Slow Channel — the oscilloscope will be triggered on a Slow Channel Message.

Frame (short serial message) — The 16-bit message consists of a 4 bit Message ID nibble, 2 nibbles (1 byte) of data, and a CRC checksum nibble. If ID and data match, then trigger on the end of CRC bit.

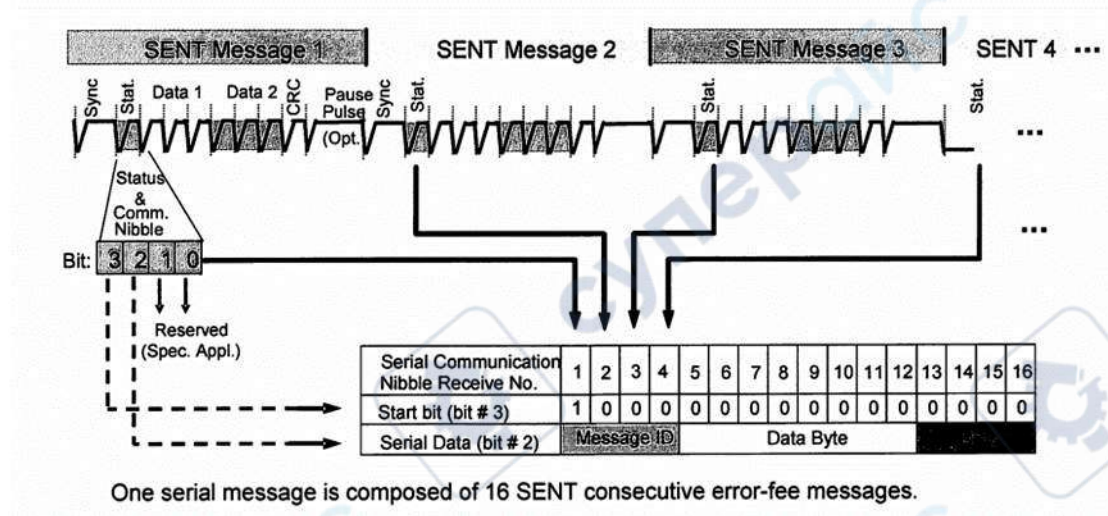

The serial message frame contains 21 bits of payload data. Two different configurations can be chosen determined by the configuration bit (serial data bit #3, serial communication nibble No. 8):

Frame (enhanced serial message with 4bits ID) —16-bit data and 4-bit message ID, the configuration bit is 1.

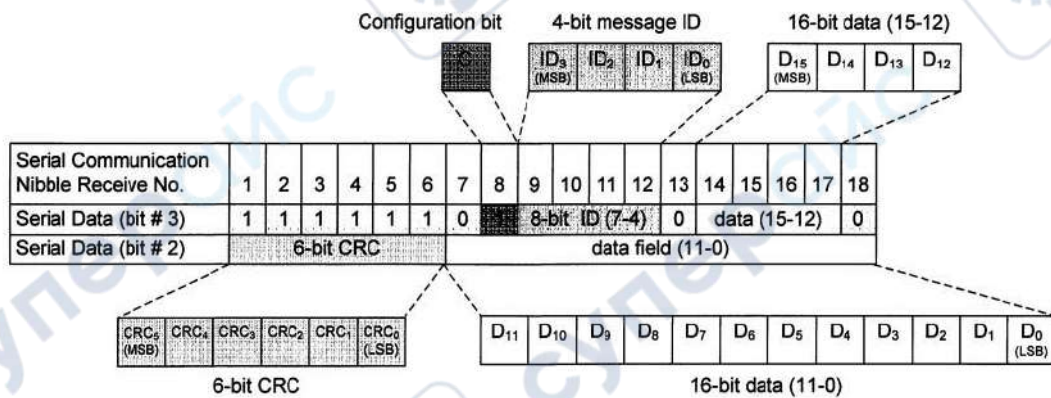

Frame (enhanced serial message with 8bits ID) —12-bit data and 8-bit message ID, the configuration bit is 0.

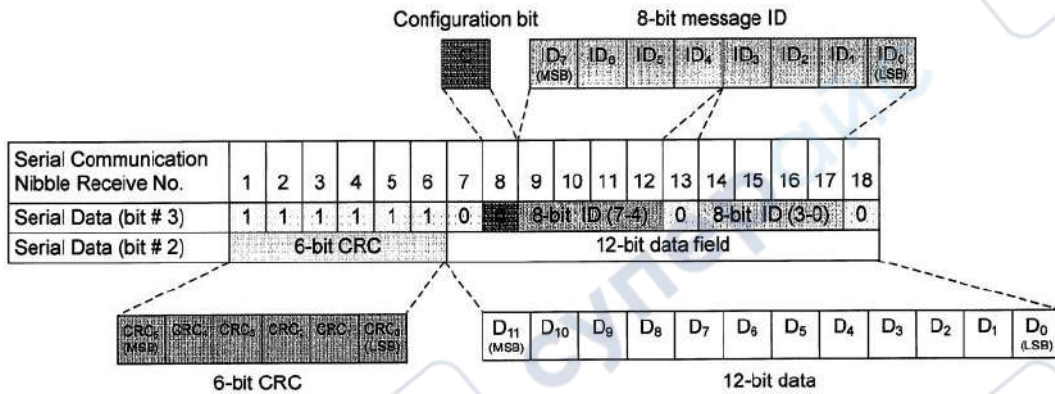

If you set the trigger condition to Slow Channel:

- **ID** can be selected in the hexadecimal range of 0x0 to 0xF (short serial / enhanced serial with 4 bits ID) or 0x00 to 0xFF (enhanced serial with 8 bits ID). If it is selected as "0xXX", the ID is ignored.
- **Compare Type** can be specified as Equal, Not Equal, Less than, Less or Equal, Greater than, Greater or Equal, in Range of, out of Range.
- **Data** can be selected in the hexadecimal range of 0x00 to 0xFF (short serial) or 0x0000 to 0xFFFF (enhanced serial with 4 bits ID) or 0x000 to 0Xfff (enhanced serial with 8 bits ID). If it is selected as "0xXX", the data is ignored.

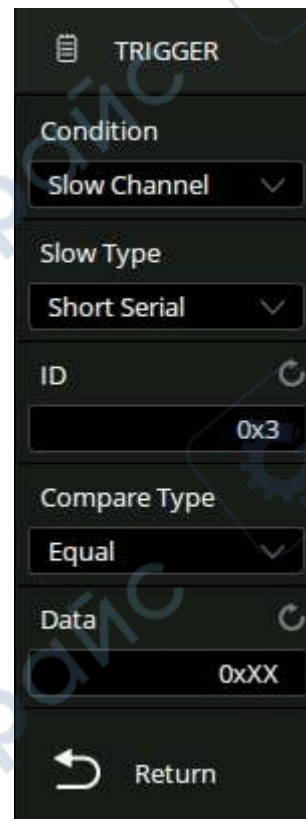

Error — the oscilloscope triggers on the error frame. Errors include

Successive Sync Pulses Error, Pulse Period Error, Fast Channel CRC Error, Slow Channel CRC Error, All CRC Errors.

- Successive Sync Pulses Error: triggers on a sync pulse whose width varies from the previous sync pulse's width by greater than 1/64 (1.5625%, as defined in the SENT specification).
- Pulse Period Error: triggers if a nibble is either too wide or too narrow (for example, data nibble < 12 (11.5) or > 27 (27.5) ticks wide). Sync, S&C, data, or checksum pulse periods are checked.
- Fast Channel CRC Error: triggers on any Fast Channel Message CRC error.
- Slow Channel CRC Error: triggers on any Slow Channel Message CRC error.
- All CRC Errors: triggers on any CRC error, Fast or Slow.

16.11.3 SENT Serial Decode

The configuration of SENT decoding is similar to that of I2C decoding.

On the bus:

For Fast Channel:

- SYNC is displayed in pink
- STATE is displayed in green
- DATA is displayed in white
- CRC and Pause pulse are displayed in blue

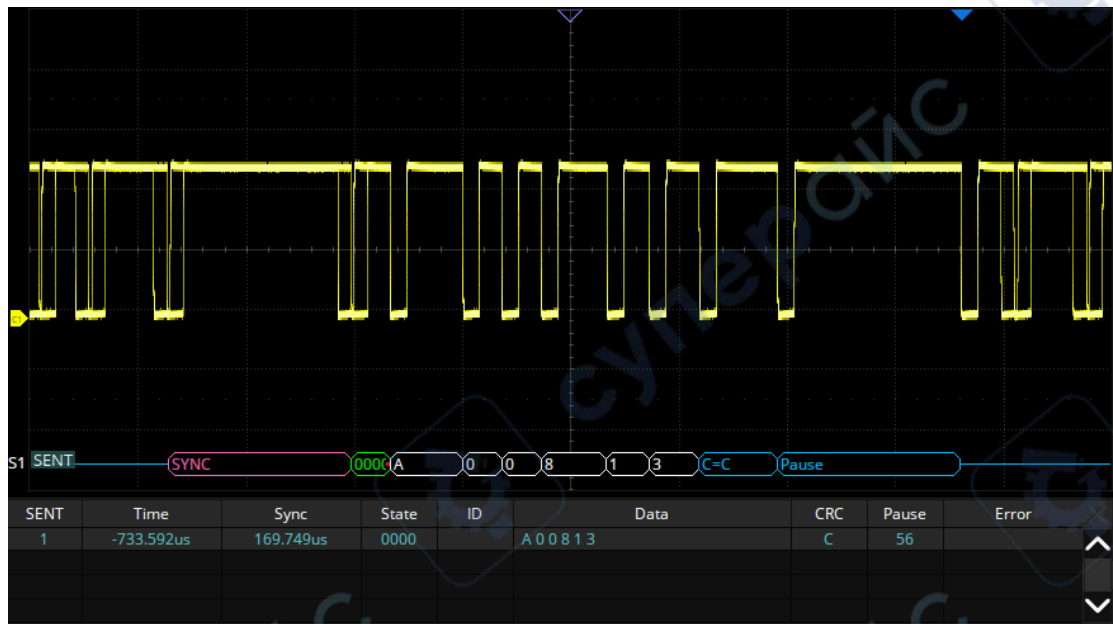

For Slow Channel:

- ID is displayed in green
- DATA are displayed in white
- CRC is displayed in blue

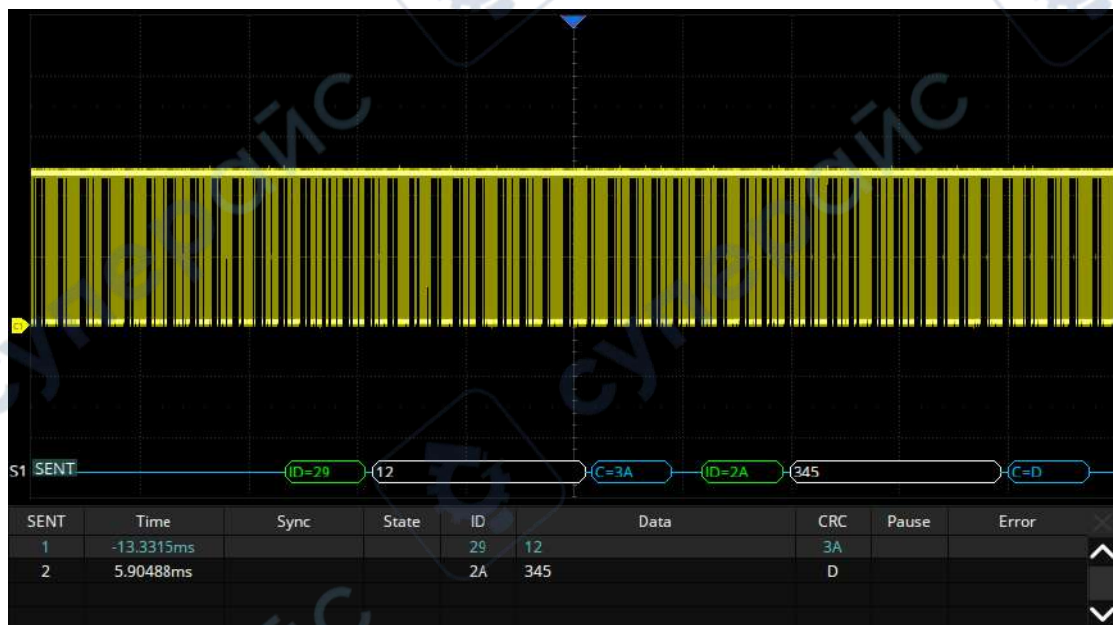

In the list view:

- Time — The horizontal offset of the current data frame head relative to the trigger position.
- Sync — Sync pulse width (only fast channel)
- State — Status & Communication nibble (only fast channel)
- ID — ID of the frame. (only slow channel)
- Data — Data values
- CRC — Cycle redundancy check
- Pause — Pause ticks
- Error — Error type

16.12 Manchester Serial Decode

This section covers decoding Manchester signals. Please read the following for more details: "Manchester Signal Settings" and "Manchester Serial Decode".

16.12.1 Manchester Signal Settings

Connect the Manchester signal to the oscilloscope, set the mapping relation between channels and signals, and then set the threshold level of signal. The process of specifying the source and threshold is similar to "I2C Signal Settings"

In the *BusConfig* menu of decode, the following parameters are available:

- A. Touch to specify the baud rate, the range is 500b/s to 5Mb/s
- B. Set the Manchester signal's logic type. R:1 indicates that rising edge is used to encode a bit value of logic 1, and F:1 indicates that falling edge is used to encode a bit value of logic 1
- C. Set the idle level
- D. Set the starting edge of the Manchester signal. The range is 1~32
- E. Set the minimum idle time/inter-frame gap time of the Manchester bus in terms of the bit width.
- F. Set the display format to Byte or Bit
- G. Set the bit order to MSB or LSB
- H. Set the sync field size, from 0 to 32
- I. Set the header size, from 0 to 32
- J. Set the number of words in data field, from 1 to 255
- K. Set the data word size, from 2 to 8
- L. Set the trailer size, from 0 to 32
- M. Return to previous menu

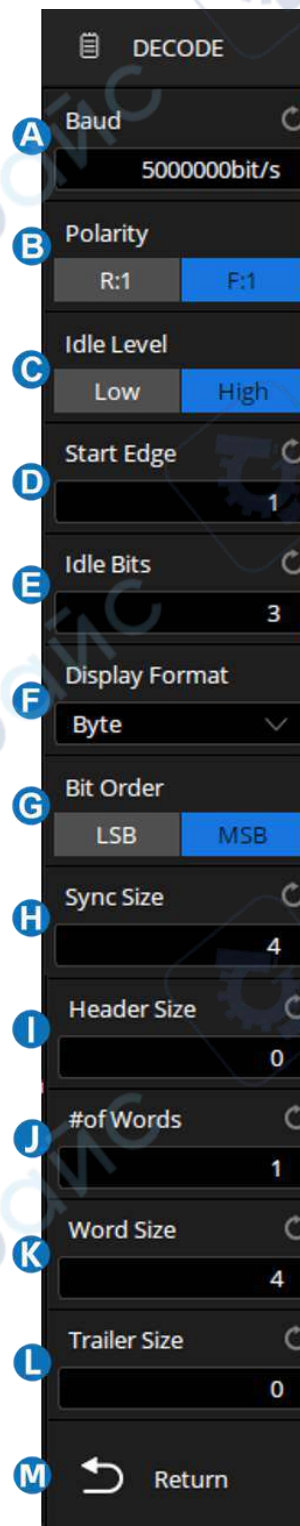

16.12.2 Manchester Serial Decode

The configuration of Manchester decoding is similar to that of I2C decoding.

On the bus:

- SYNC is displayed in pink
- Header is displayed in green
- DATA is displayed in white
- Trailer is displayed in blue

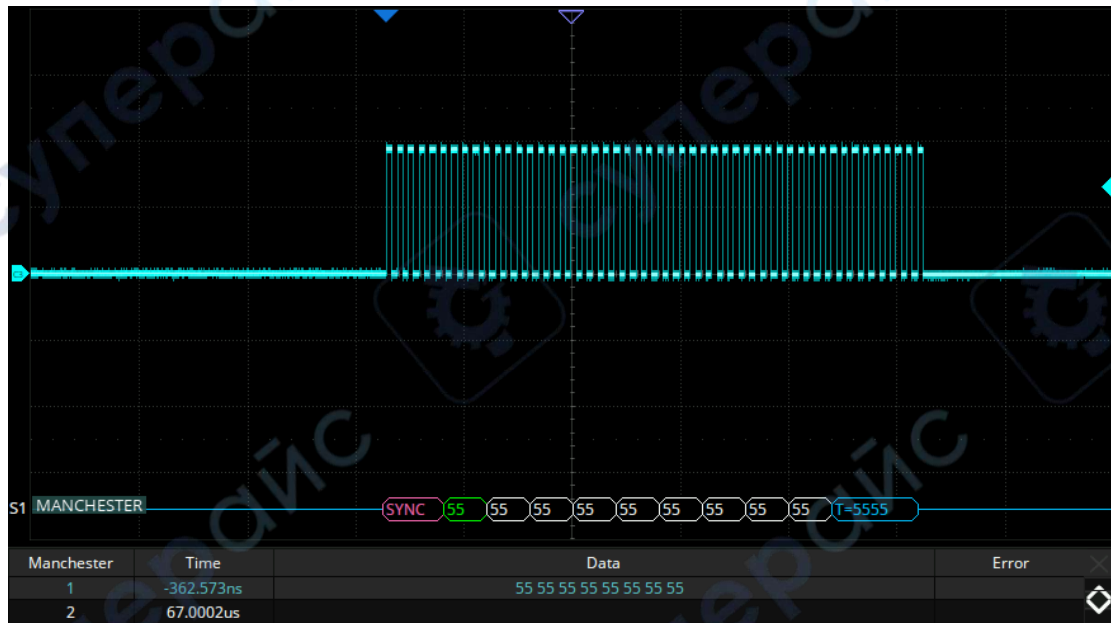

In the list view:

- Time — The horizontal offset of the current data frame head relative to the trigger position.
- Data — Data words
- Error — Error type

17 Cursors

17.1 Overview

Cursors are important tools when measuring signals. Rapid measurements can be performed using cursors in both horizontal and vertical directions. The cursor types include X1, X2, X1-X2, Y1, Y2 and Y1-Y2, used to indicate X-axis values (time or frequency) and Y-axis values (amplitude) on a selected waveform (CH1/CH2/CH3/CH4/F1/F2/REFA/REFB/REFC/REFD).

Press the **Cursors** button on the front panel or touch the menu *Cursors* > *Menu* to open cursors dialog box:

- A. Turn on or off cursors function
- B. Cursors Mode. The vertical cursors will automatically track the waveform in Trace mode.
- C. Specify the cursor and set the position (by gestures, universal knob, or virtual keypad)
- D. Cursors type (horizontal, vertical, horizontal + vertical), this option is supported only in "Manual" mode.
- E. Select the source
- F. Display mode of cursors
- G. X cursors reference (Delay or Position)
- H. Y cursors reference (Offset or Position), this option is supported only in "Manual" mode.

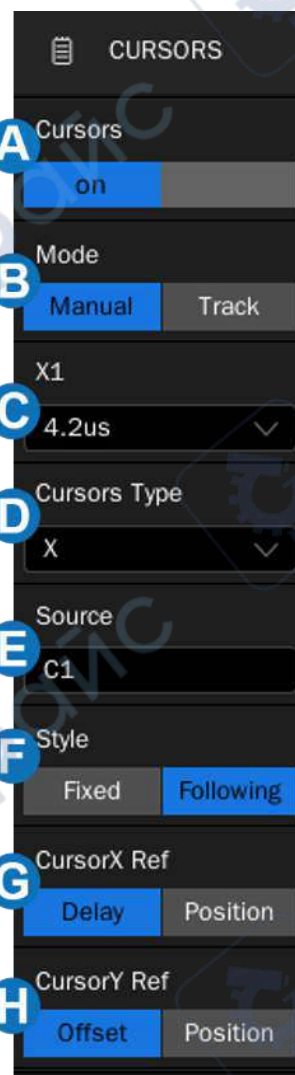

Cursors Mode

- Manual — Manually set the cursors' position. Cursors type

(horizontal, vertical, horizontal + vertical) is available in this mode.

- Track -- The cursor type is automatically set to "horizontal + vertical". In this mode, only horizontal cursors are adjustable, while the vertical cursors automatically attach to the cross-point of the cursor and the source waveform.

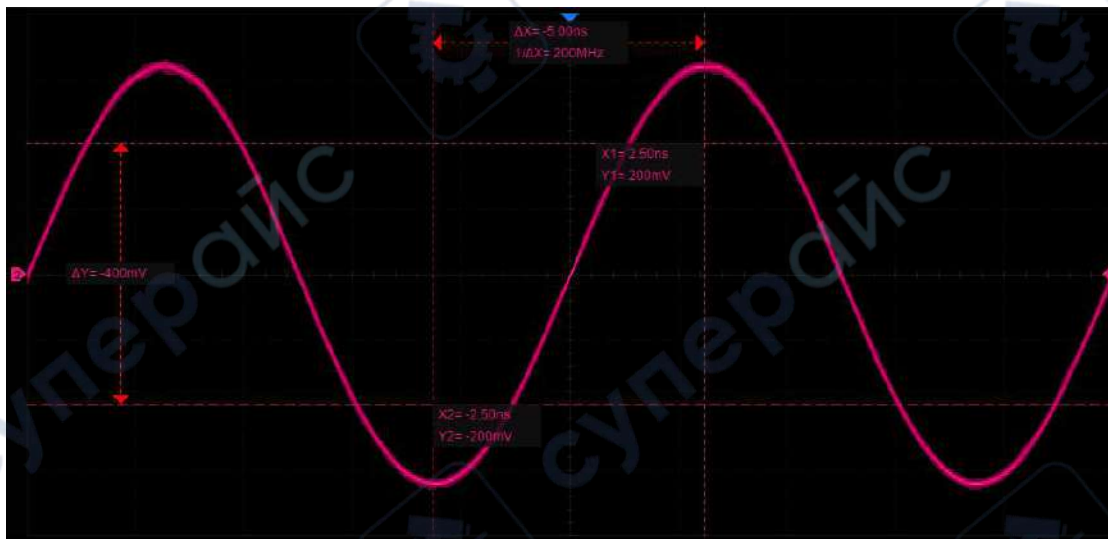

Manual Mode

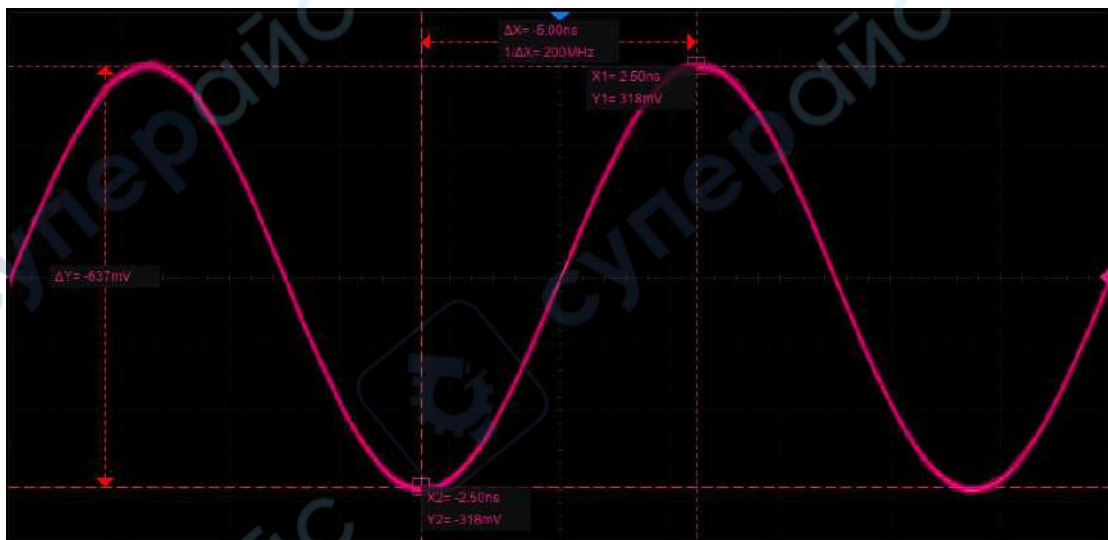

Track Mode

Cursors Type

X (horizontal) -- Vertical dotted lines that measure horizontal time (when the source is an FFT waveform, X cursors measure frequency).

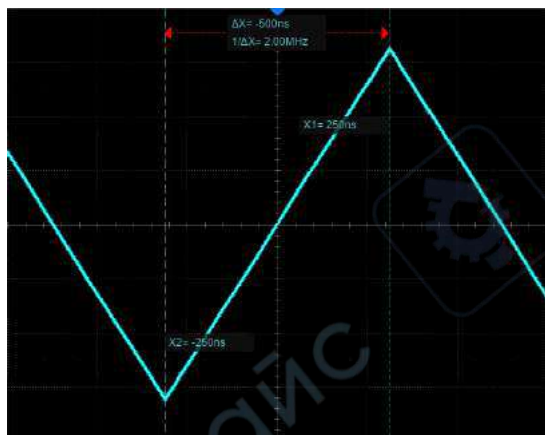

X cursors (time)

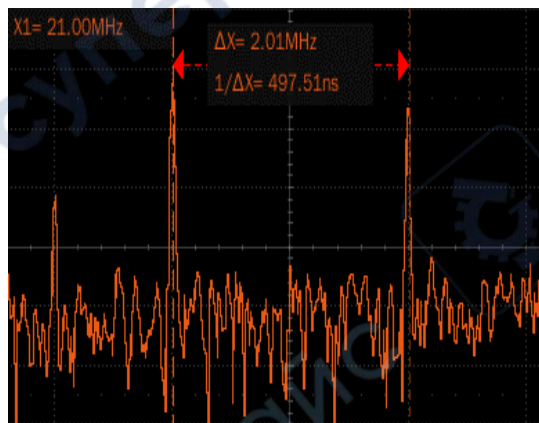

X cursors (frequency)

- **X1** — The left (default) vertical dotted line. It can be manually moved to any horizontal position on the screen.
- **X2** — The right (default) vertical dotted line. It can be manually moved to any horizontal position on the screen.
- **X1- X2** — The difference between X1 and X2. After this option is selected, turning the universal knob will move both X1 and X2 simultaneously.

Y (vertical) - Horizontal dotted lines that measure vertical voltage or current (depending on the unit of the selected channel). When the cursor's source is the math function, the units will match the math function.

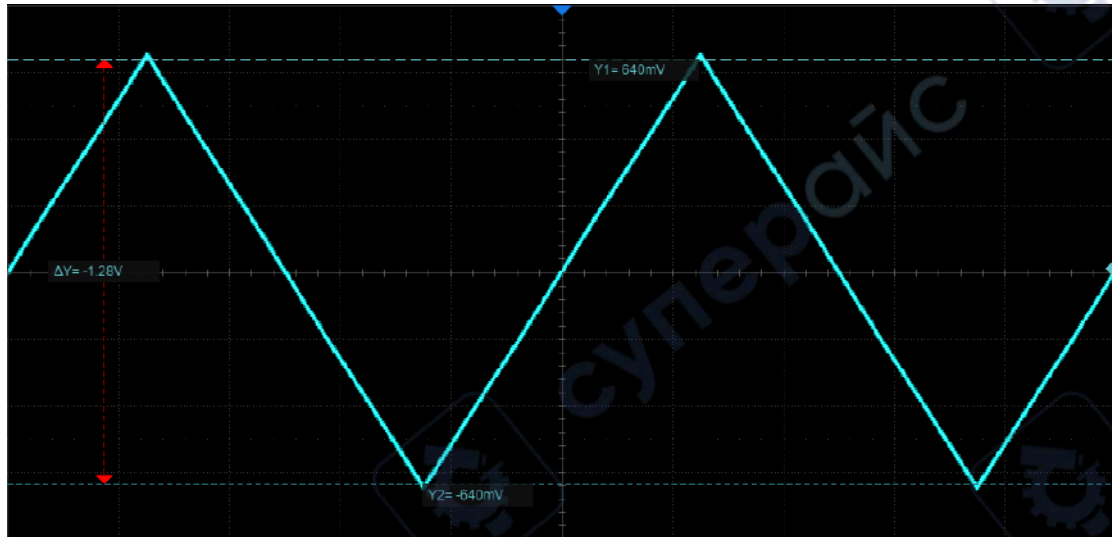

- **Y1** — The upper (default) horizontal dotted line. It can be manually moved to any vertical position on the screen.
- **Y2** — The lower (default) horizontal dotted line. It can be manually moved to any vertical position on the screen.
- **Y1- Y2** — The difference between Y1 and Y2. After this option is selected, turn the universal knob to move both Y1 and Y2 simultaneously.

X+Y (horizontal + vertical) — Both the X cursors and Y cursors are enabled.

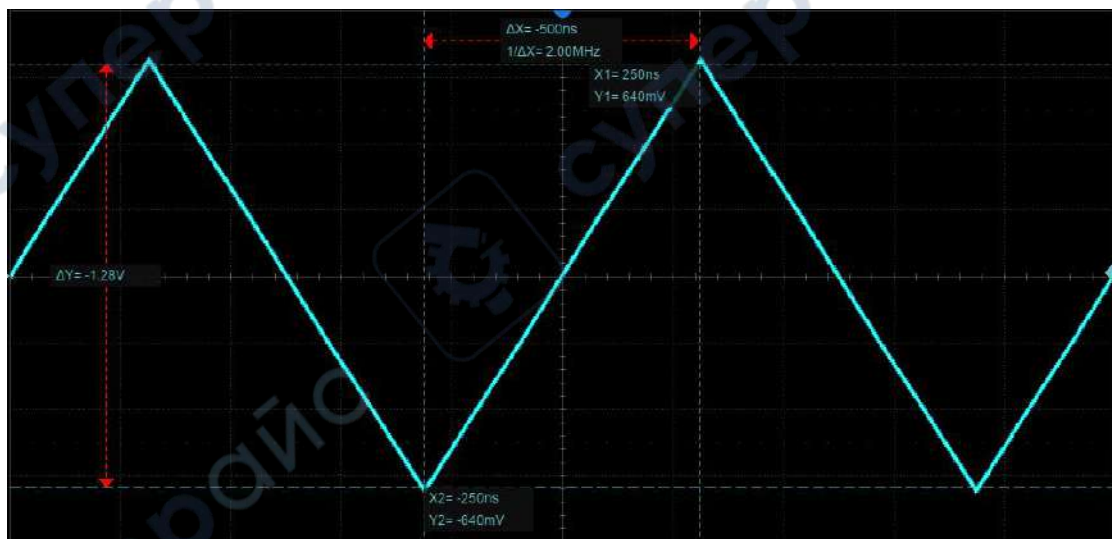

Display Mode

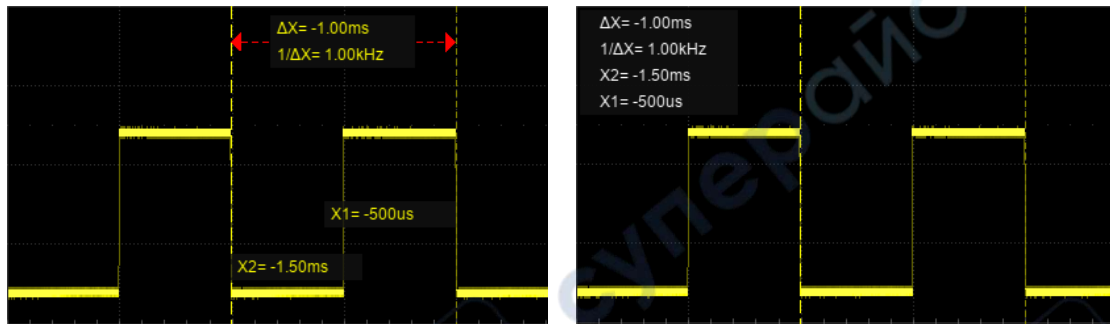

Display Mode M1

Display Mode M2

- M1 - The position information of each cursor is attached to the cursor, and the difference information is between the two cursors with arrows connected to the cursors. This mode is more intuitive.
- M2 — The position information of each cursor and the difference between the cursors are displayed in a region on the screen. The region can be moved by gestures to avoid covering the waveform. This mode is relatively concise.

Cursors Reference

X cursors reference:

- Fixed Delay - When the timebase is changed, the value of X cursors remain fixed.
- Fixed Position - When the timebase is changed, the X cursors remain fixed to the grid position on the display.

Y cursors reference:

- Fixed Offset - When the vertical scale is changed, the value of Y cursors remain fixed.
- Fixed Position - When the vertical scale is changed, the y

cursors remain fixed to the grid position on the display.

Take X cursors reference as an example to demonstrate the scaling effect of different settings:



Timebase=50 ns/div, $X1 = -50\text{ ns} = -1\text{div}$, $X2 = 100\text{ ns} = 2\text{div}$



Fixed position, timebase is changed to 100ns/div, the grid number of X cursors (-1div, 2div) remains fixed. The value of X1 and X2 are changed to -100 ns, 200 ns.



Fixed delay, timebase is changed to 100 ns/div, the value of X cursors (-50 ns, 100 ns) remains fixed. The grid number of X cursors are changed to -0.5 div, 1 div.

17.2 Select and Move Cursors

The cursors can be selected and moved directly by gestures and the universal knob on the front panel, in addition, they can be selected in the cursors dialog box.

Gestures

Directly touch the cursor and drag it, as shown below:

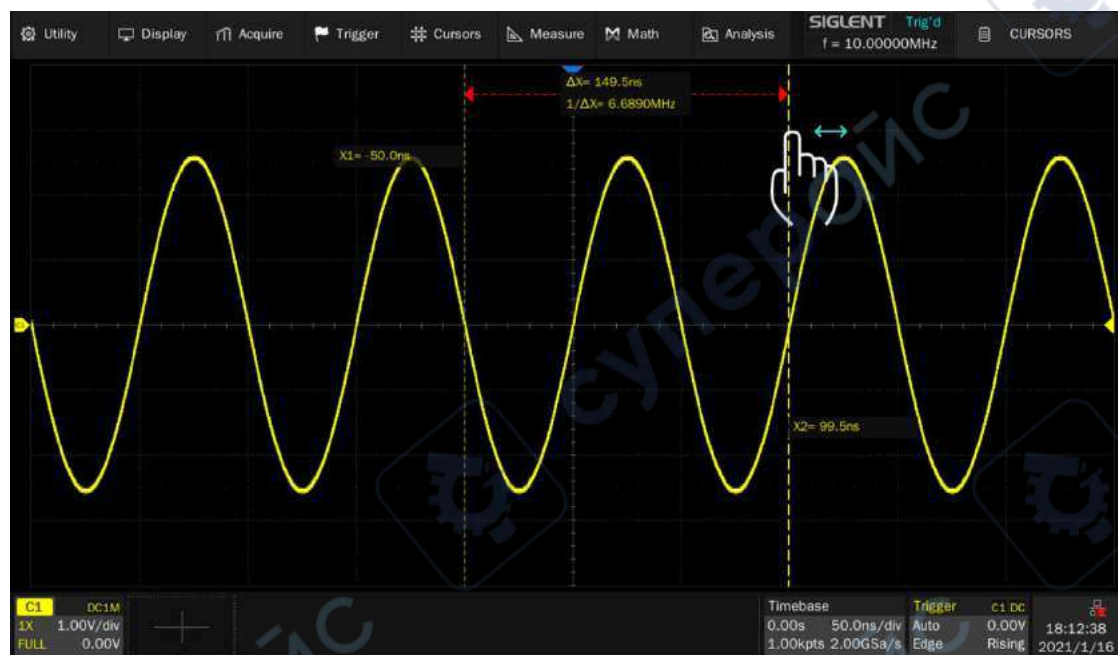

Touch the display area of ΔX (or ΔY) in M1 mode and drag it to move the two cursors simultaneously, as shown in the figure below. This is equivalent to the operation on the cursor type X1-X2 or Y1-Y2.

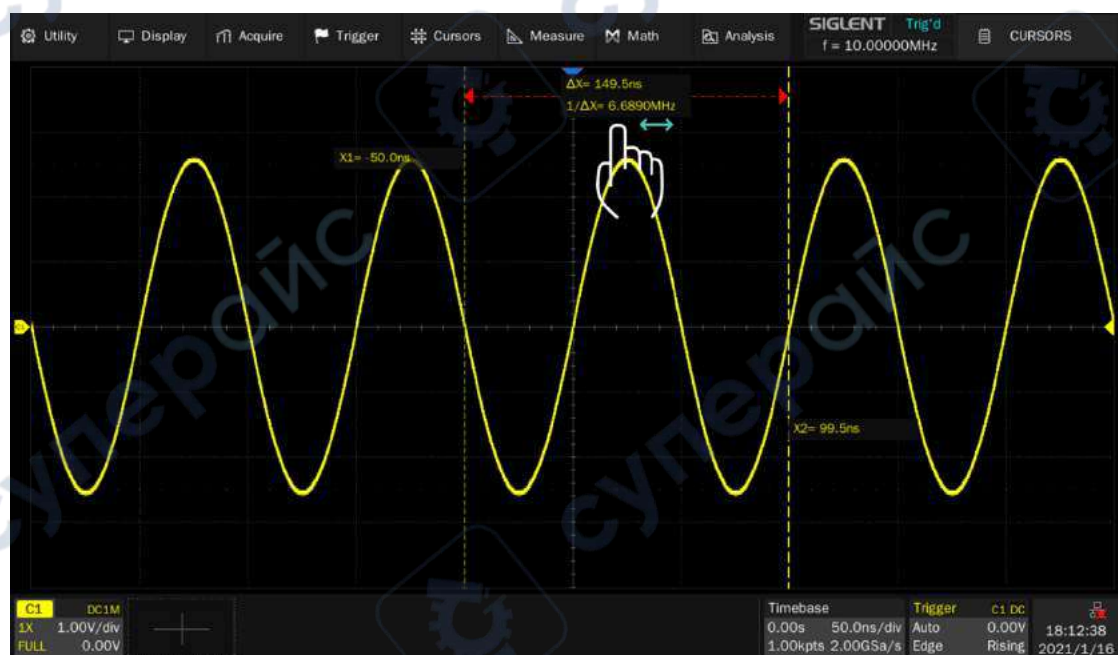

Universal Knob

Move the cursor position by turning the universal knob on the front panel. Press the knob to select different cursor lines. For example,

if the current cursor is X1, press to select X2, and press again to select X1-X2.

Gestures move the cursor quickly but not precisely, while the knob moves the cursor precisely but not as quickly. You can use both in combination to suit your needs: First, a rough adjustment is achieved by using gestures and then a fine adjustment is achieved by using the universal knob.

Dialog Box

Touch the cursor name area of the dialog box, select the cursor(s) in the pop-up list, and then rotate the universal knob to adjust the position.

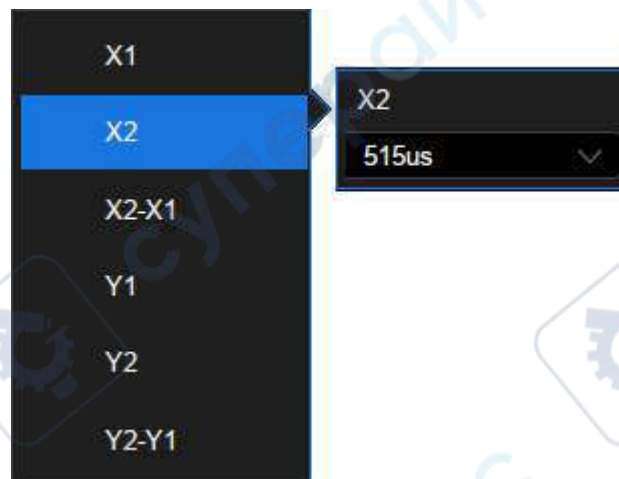

18 Measurement

18.1 Overview

The SDS2000X Plus features a strong automatic measurement list. These parameters can be automatically measured without cursors and include common measurements such as rise time, fall time, peak-peak, and period. The SDS2000X Plus can also measure multiple channels at the same time, showing up to 5 parameter measurements with statistics while in the M1 display mode and up to 12 parameters in the M2 mode. If you wish to view more parameters on a specified channel, then the "Simple" mode can be employed. For measuring waveform of interest in a time gate, the "Gate" function is suggested.

Some parameter measurements (such as the mean) may be a value generated by all the data in a frame. Some parameter measurements (such as period) accumulate all measurements in a frame, but the displayed value is always the first value. If you want to know the distribution of multiple parameters in one frame, you should use the statistics function.



- The waveform display area automatically compresses when the other windows are displayed
- Measurement parameters and statistics display area. If select the mode as “Simple”, the “Simple” parameter area is displayed
- Statistics histogram display area
- Measure dialog box

Press the **Measure** button on the front panel or touch **Measure**>**Menu** to open the dialog box.

- A. Enable/disable measure
- B. Set the mode of measure: Simple or Advanced. "Simple" shows the specified basic measurement parameters of the selected channel. In "Advanced" mode, the measurement parameters can be added one-by-one as needed
- C. Measure configuration: gate, amplitude strategy, threshold and display mode
- D. Clear all the selected measurements
- E. Select measurement parameters
- F. Turn on the trend plot of the selected measurement
- G. Turn on or off statistics
- H. Statistics settings: count limit, reset statistics and histogram

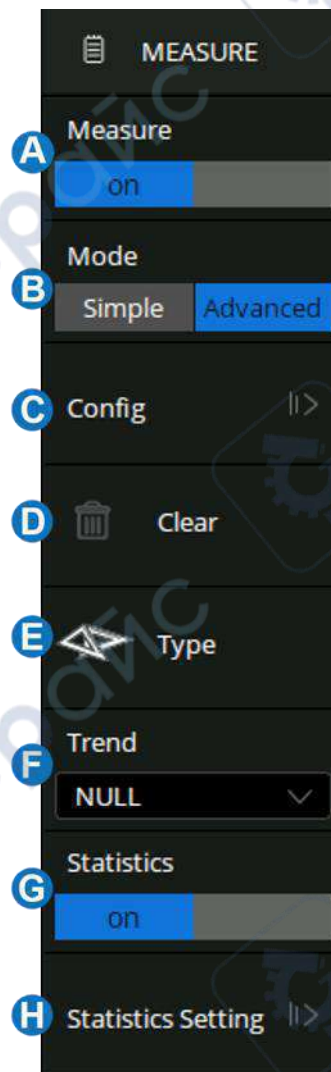

18.2 Set Parameters

Touch **Type** in the measure dialog box, or touch **+** in the measurement parameters and statistics display area to open the parameter selection window:

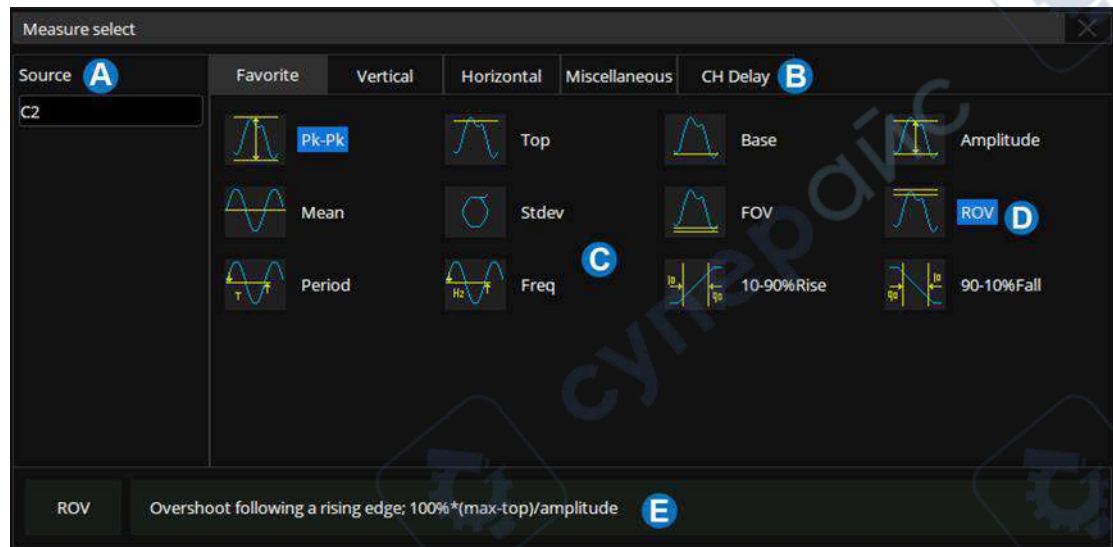

- A. Set the source of the current setting.
- B. Measurement parameter classification tabs, including Favorite, Vertical, Horizontal, Miscellaneous and CH Delay. Touch a tab and in the C area will display the corresponding parameters
- C. Parameters. Touch the parameter to be measured to activate it, and touch it again to close the parameter.
- D. Background highlighted parameters represent it is activated. In the figure above, "Pk-Pk" and "ROV" are activated.
- E. Description of the last selected parameter.

The correct steps to add a measurement parameter are to select the source in the A area and then select the parameter in the C area. For example, to add Pk-Pk measurements for C1 and Period measurements for C2, follow the steps below:

```
Source>C1>Vertical>Pk-Pk
```

```
Source>C2>Horizontal>Period
```

For the channel delay (CH Delay) measurement, because the number of

sources involved is greater than 1, the steps to specify the source is different:



In the parameter selection area, the channel corresponding to *Source A* is specified first, and then the channel corresponding to *Source B*. Finally, the measurement parameter is selected. For example, to activate the skew between C1 and C2, you can follow the following steps:

Source A>C1>*Source B*>C2>Skew

Once a parameter is selected, it will appear in the parameter and statistical display area below the grid:



Touch + in the blank area to add a parameter.

Touch - in the upper right corner of each parameter to close the parameter.

Touch × in the upper right corner of the area to close measurement.

Touch *Clear* in the dialog box to close all parameters.

The “Favorite” tab is used to store frequently used items. You can customize this tab. Up to 20 items can be stored in it. Long-press an

item to add or remove it from the “Favorite” tab. For example, to add Pk-Pk to the “Favorite” tab:

Advanced>Type >Vertical>Pk-Pk>Add to favorite

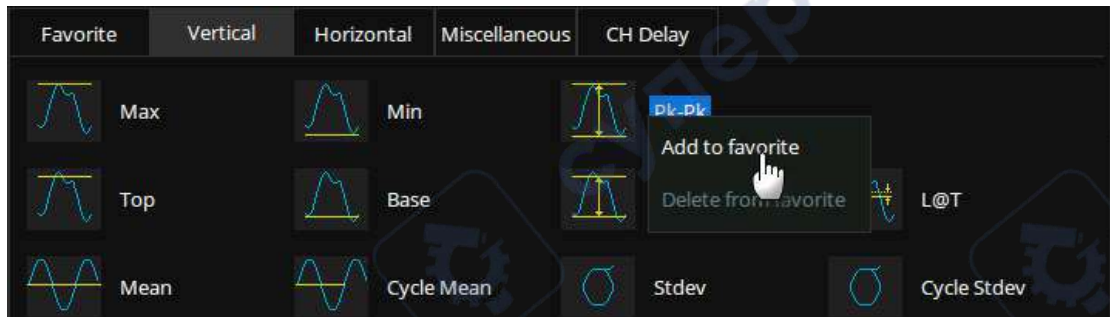

To remove Period from the “Favorite” tab:

Advanced>Type >Favorite>Period>Delete from favorite



18.3 Type of Measurement

18.3.1 Vertical Measurement

Vertical measurement includes 19 parameters:

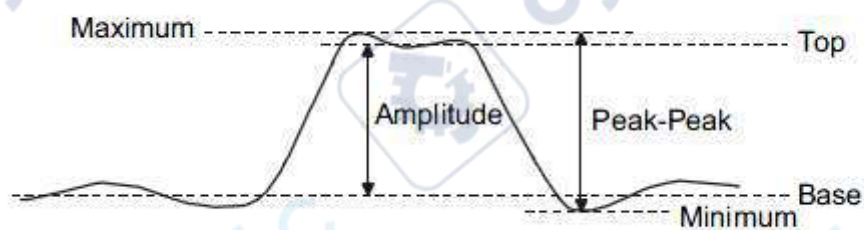
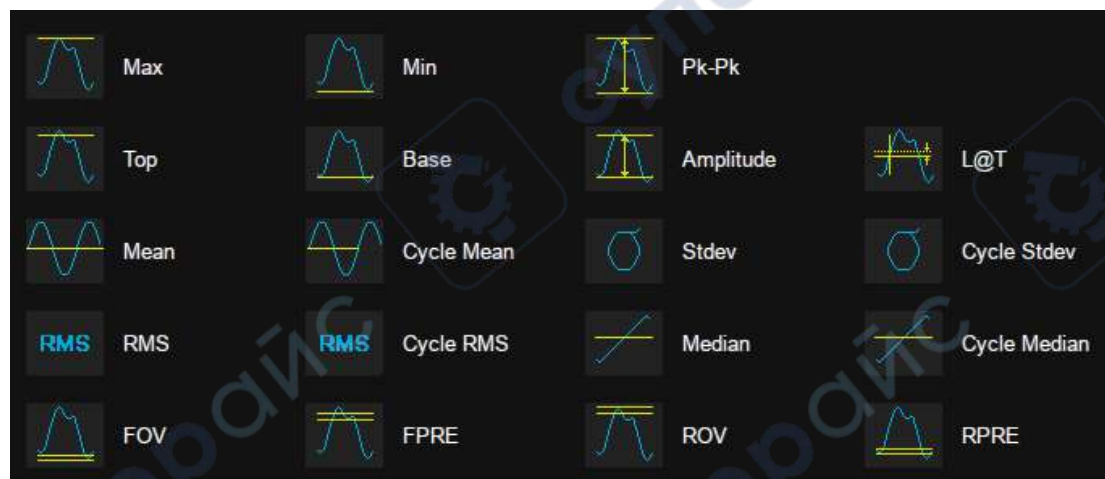

- **Max:** Highest value in the input waveform
- **Min:** Lowest value in the input waveform
- **Pk-Pk:** Difference between maximum and minimum data values
- **Top:** Value of most probable higher state in a bimodal waveform
- **Base:** Value of most probable lower state in a bimodal waveform
- **Amplitude:** Difference between top and base in a bimodal waveform

waveform. If not bimodal, the difference between max and min

- **Mean:** Average of data values
- **Cycle Mean:** Average of data values in the first cycle
- **Stdev:** Standard deviation of the data
- **Cycle Stdev:** Standard deviation of the data in the first cycle
- **RMS:** Root mean square of the data
- **Cycle RMS:** Root mean square of the data in the first cycle
- **Median:** Value at which 50% of the measurements are above and 50% are below
- **Cycle Median:** Median of the first cycle
- **Overshoot (FOV):** Overshoot following a falling edge; $100\% \times (\text{base} - \text{min}) / \text{amplitude}$
- **Overshoot (ROV):** Overshoot following a rising edge; $100\% \times (\text{max} - \text{top}) / \text{amplitude}$

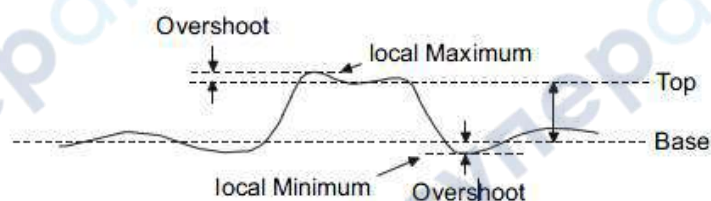

$$\text{Rising Edge Overshoot} = \frac{\text{Maximum} - \text{Top}}{\text{Amplitude}} \times 100\%$$

$$\text{Falling Edge Overshoot} = \frac{\text{Minimum} - \text{Base}}{\text{Amplitude}} \times 100\%$$

- **Preshoot (FPRE):** Overshoot before a falling edge.

Equal to $100 \% * (\text{max} - \text{top}) / \text{amplitude}$.

- **Preshoot (RPRE):** Overshoot before a rising edge.

Equal to $100 \% * (\text{base} - \text{min}) / \text{amplitude}$.

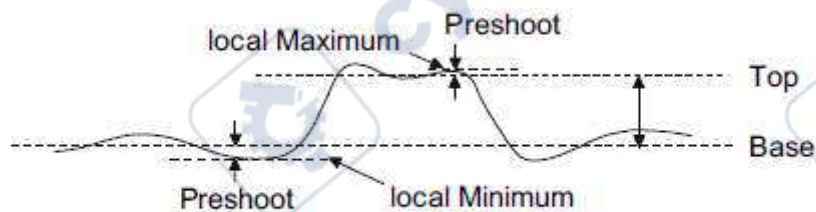

$$\text{Falling Edge Preshoot} = \frac{\text{Maximum} - \text{Top}}{\text{Amplitude}} \times 100\%$$

$$\text{Rising Edge Preshoot} = \frac{\text{Minimum} - \text{Base}}{\text{Amplitude}} \times 100\%$$

- **L@T:** Level measured at trigger position

18.3.2 Horizontal Measurement

Horizontal measurement includes 17 parameters:

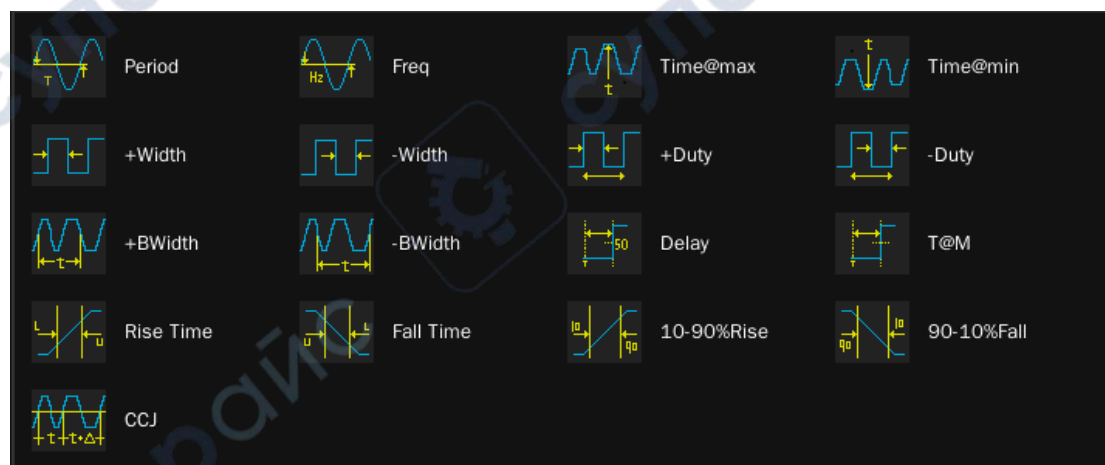

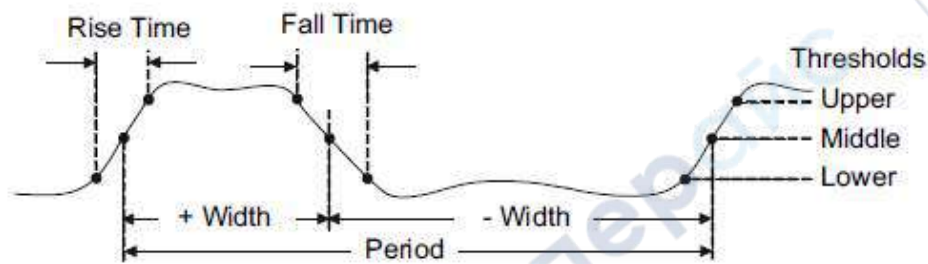

- **Period:** Time between the middle threshold points of two consecutive like-polarity edges.
- **Freq:** Reciprocal of period
- **Time@max:** Time of maximum value
- **Time@min:** Time of minimum value
- **+Width:** Time difference between the middle threshold of a rising edge to the middle threshold of the next falling edge of the pulse
- **-Width:** Time difference between the middle threshold of a falling edge to the middle threshold of the next rising edge of the pulse
- **+Duty:** Positive Duty Cycle. Ratio of positive width to period
- **-Duty:** Negative Duty Cycle. Ratio of negative width to period
- **+BWidth:** Time from the first rising edge to the last falling edge at the middle threshold
- **-BWidth:** Time from the first falling edge to the last rising edge at the middle threshold
- **Delay:** Time from the trigger to the first transition at the

middle threshold

- **T_M**: Time from the trigger to each rising edge at the middle threshold
- **Rise Time**: Duration of rising edge from lower threshold to upper threshold
- **Fall Time**: Duration of falling edge from upper threshold to lower threshold
- **10–90% Rise**: Duration of rising edge from 10–90%
- **90–10% Fall**: Duration of falling edge from 90–10%
- **CCJ**: The difference between two consecutive periods

18.3.3 Miscellaneous Measurements

The Miscellaneous measurements tab includes 14 parameters:



- **+Area@DC**: Area of the waveform above zero
- **-Area@DC**: Area of the waveform below zero

- **Area@DC:** Area of the waveform
- **AbsArea@DC:** Absolute area of the waveform
- **+Area@AC:** Area of the waveform above average
- **-Area@AC:** Area of the waveform below average
- **Area@AC:** Area of the waveform above average minus area of the waveform below average
- **AbsArea@AC:** Area of the waveform above average add area of the waveform below average
- **Cycles:** Number of cycles in a periodic waveform
- **Rising Edges:** Number of rising edges in a waveform
- **Falling Edges:** Number of falling edges in a waveform
- **Edges:** Number of edges in a waveform
- **Ppulses:** Number of positive pulses in a waveform
- **Npulses:** Number of negative pulses in a waveform

18.3.4 Delay Measurement

Delay measurement measures the time difference between two channels.

It includes 10 delay parameters:



- **Phase:** Phase difference between two edges
- **Skew:** Time of source A edge minus time of nearest source B edge
- **FRFR:** The time between the first rising edge of source A and the following first rising edge of source B at the middle threshold
- **FRFF:** The time between the first rising edge of source A and the following first falling edge of source B at the middle threshold
- **FFFR:** The time between the first falling edge of source A and the following first rising edge of source B at the middle threshold
- **FFFF:** The time between the first falling edge of source A and the following first falling edge of source B at the middle threshold
- **FRLR:** The time between the first rising edge of source A and the last rising edge of source B at the middle threshold
- **FRLF:** The time between the first rising edge of source A and the last falling edge of source B at the middle threshold
- **FFLR:** The time between the first falling edge of source A and the last rising edge of source B at the middle threshold
- **FFLF:** The time between the first falling edge of source A

and the last falling edge of source B at the middle threshold

18.4 Trend

After adding a measurement parameter, Trend can be used to observe the change of the selected measurement value over time.

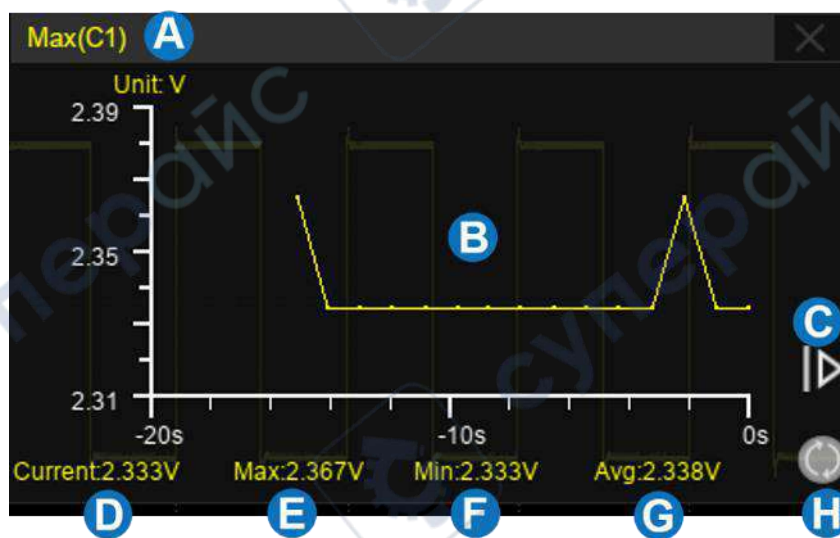

- A. Measurement parameter display area
- B. Trend plot display area
- C. Extend the range of time. Touch it to expand the time range.
- D. Current value
- E. Maximum value
- F. Minimum value
- G. Average value
- H. Reset statistics

Press **Clear Sweeps** button or touch **Reset Statistics** in the measure dialog box, or touch the symbol  in the statistics display area to clear and restart statistics.

18.5 Display Mode

In advanced measurement mode, two display modes are supported: M1 and M2.

In M1 mode, up to 5 parameter measurements are displayed at a time. When statistics are enabled, they are listed under the measurement items. Touch a column to add or replace a measurement.



In M2 mode, up to 12 parameter measurements are displayed at a time. When statistics are enabled, they are distributed on the right side of the measurement item. Touch a row to add or replace a measurement.



18.6 Measurement Statistics

Touch *Statistics Setting* in the measure dialog box to recall the statistics config dialog box:

- A. Set the maximum number of samples for the statistics function. The setting range is 0 ~ 1024, or unlimited. If there is no limit, the number of statistics will be accumulated. If there is a limit, when the maximum number of statistics N is reached, only the latest N measurements will be counted. When count is limited, only the first period

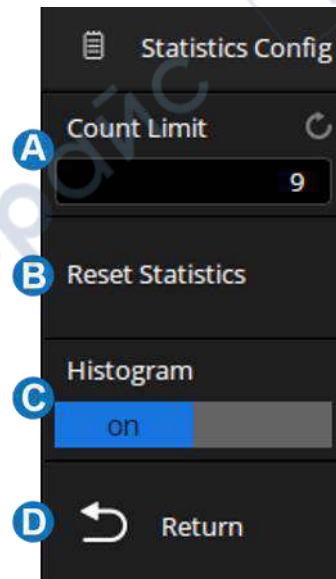

measurement value of each frame
is counted

- B. Clear and restart the statistics. Pressing the **Clear Sweeps** button on the front panel has an equivalent effect
- C. Turn on or off histogram
- D. Return to previous menu

Enable the **Statistics** function to observe the distribution of the measured values of every selected parameter.

MEASURE	Pk-Pk(C1)	Base(C1)	Period(C1)	Rise(C1)	+Duty(C1)
Value	3.17V	-1.50V	1.00ms	2.00ns	50.00%
Mean	3.16V	-1.50V	994.90us	3.49ns	50.38%
Min	3.15V	-1.50V	500.00us	2.00ns	0.00%
Max	3.17V	-1.50V	1.50ms	6.40ns	100.00%
Sdev	7.67mV	0.0pV	87.33us	1.52ns	7.80%
Count	82	62	196	37	132

- **Value** - The current measurement
- **Mean** - Average of all historical measurements
- **Min** - The minimum of all historical measurements
- **Max** - The maximum of all historical measurements
- **Stdev** - Standard deviation of all historical measurements
- **Count** - The number of historical measurements

Press the **Clear Sweeps** button or touch **Reset Statistics** in the measure dialog box, or touch the symbol  in the statistics display area to clear and restart statistics.

18.7 Statistics Histogram

After enabling statistics on a selected measurement, you can also activate a statistical histogram. The histogram appears at the bottom of the statistics area. This enables users to quickly view the probability distribution of the measured parameters. The color of the histogram is consistent with the measurement source (Channel 1 is yellow, etc.).

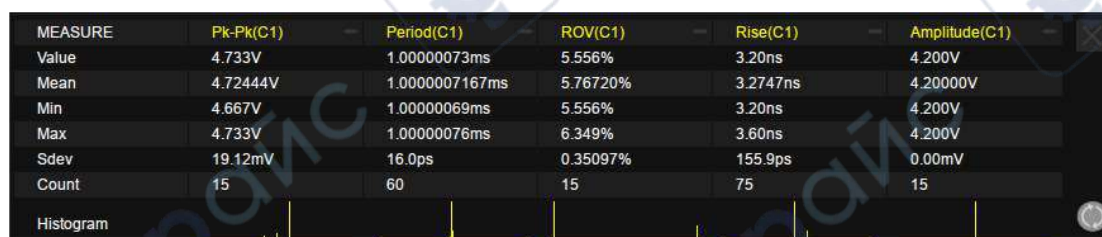

Touch the histogram area of a parameter to enlarge it for details. You can move the large histogram window position around the display by dragging. Touch the histogram of another parameter to switch to the corresponding enlarged histogram.

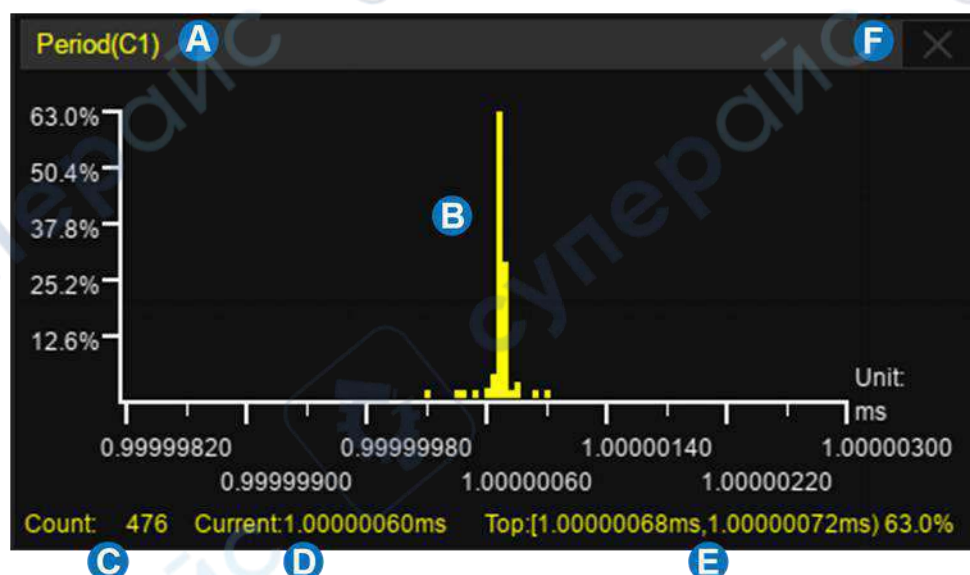

- Parameter
- Histogram display area. The X-axis represents measured values

and the Y-axis represents the probability.

- C. Count of statistics
- D. Current value
- E. The bin that includes the maximum value and the probability of a value falling into it
- F. Close the enlarged histogram

18.8 Simple Measurements

Enabling Simple Measurement displays all selected measurement parameters of the specified channel at the same time. The font color of the measurement parameters is consistent with the color of the specified source. Yellow for Channel 1, Purple for Channel 2, etc.

Max	1.58V	Cycle Mean	-4.28mV	ROV	2.22%	Rise	2.00ns
Min	-1.58V	Stdev	1.50V	RPRE	0.56%	Fall	2.00ns
PK-Pk	3.17V	Cycle Stdev	1.50V	L@T	233.33mV	BWwidth	4.50ms
Top	1.50V	RMS	1.50V	Period	1.00ms	+Duty	50.00%
Base	-1.50V	Cycle RMS	1.50V	Freq	1.00kHz	-Duty	50.00%
Amplitude	3.00V	FOV	2.78%	+Width	500.00us	Delay	-2.50ms
Mean	-4.19mV	FPRE	0.0%	-Width	500.00us	T@M	1.50ms

18.9 Gate

Sometimes the user may want to measure parameters for a certain specified time range of the signal and ignore signal parts that lie outside of that range. In this case, the Gate function can be helpful.

Touch **Gate** in the measure dialog box, then two horizontal cursors A and B will appear in the grid area. The gate setting dialog box will be displayed on the right.

Gate cursors A and B are used to define the range of time for parameter measurements. The oscilloscope only measures the parameters of the data between A and B, ignoring the data outside the range.

The setting of gate cursors is similar to that of ordinary cursors. See "Select and Move Cursors" for details.

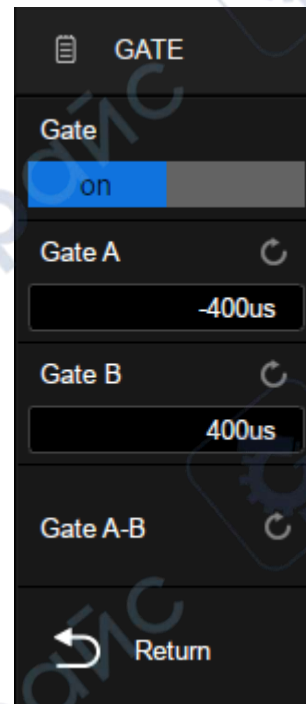

The figure below shows a scenario in which the gate function is used to measure the peak-peak parameter of the trough of an amplitude modulated waveform:

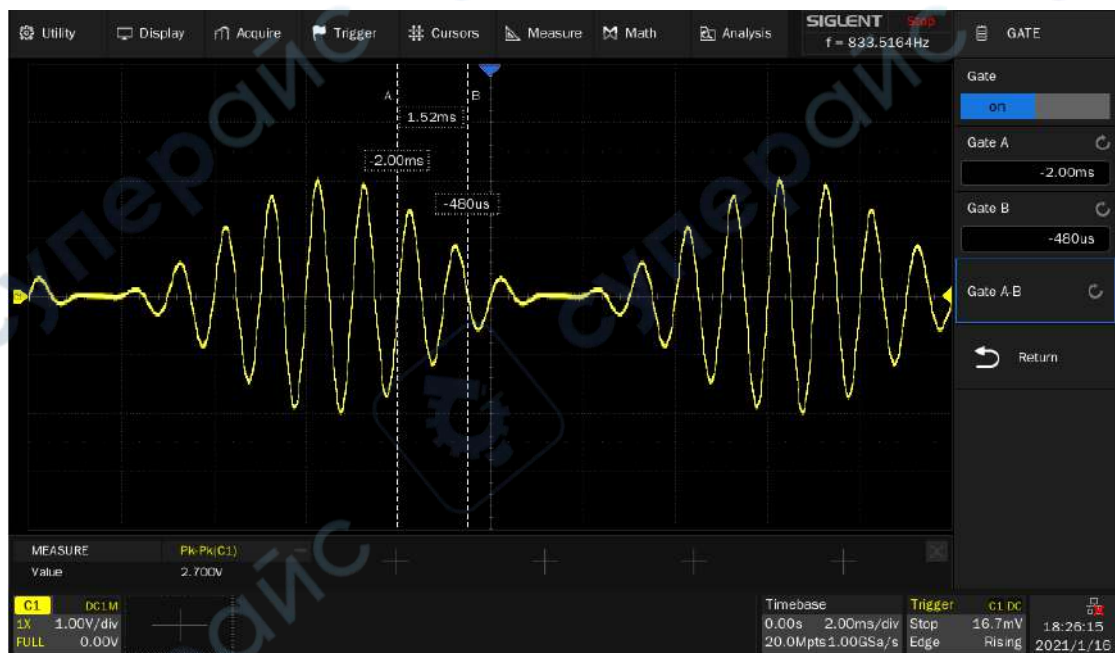

18.10 Amplitude Strategy

According to different types of input signals, users can choose the corresponding amplitude calculation strategy which can make the measurement of top value and bottom values more accurate.

Touch *Config* > *Amplitude Strategy* in the measure dialog box to recall the amplitude strategy dialog box:

- A. Set the amplitude calculation strategy. When set to auto, the amplitude calculation strategy will be selected automatically according to the input signal to ensure the accuracy of the measured value

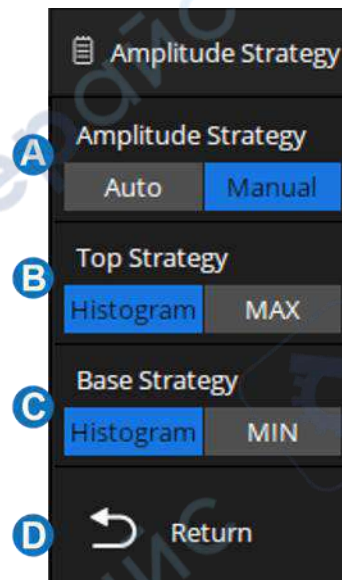

- B. Set the top value calculation strategy. When set to histogram, the value greater than half of peak value will be counted, and the value with the maximum probability will be identified as the top value; when set to max, the maximum value of waveform will be identified as the top value
- C. Set the base value calculation strategy. When set to histogram, the value less than half of peak value will be counted, and the value with the maximum probability will be identified as the base value; when set to min, the minimum

value of waveform will be identified as the base value

- D. Return to previous menu

18.11 Threshold

Measurement thresholds can be defined by the user. This is more flexible than fixed thresholds. For example, for pulse width measurement, the threshold can be specified rather than fixed at 50%. For rise time, the lower / upper thresholds can be specified rather than fixed at 10%/90%.

Changing the default threshold may change the measurement results of relevant measurement items, such as: Period, frequency, +width, -width, +duty, -duty, +Bwidth, -Bwidth, delay, T@M, rise time, fall time, CCJ, cycles, rising edges, falling edges, edges, Ppulses, Npulses, and delay measurement.

Touch *Config*>*Threshold* in the measure dialog box to recall the threshold dialog box:

- A. Set measurement threshold source
- B. Set the type of threshold
- C. Set the upper value
- D. Set the middle value
- E. Set the lower value
- F. Return to previous menu

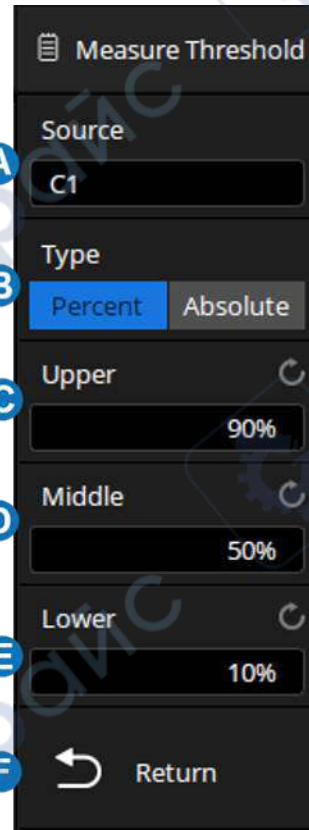

Threshold Type

Percent: Set according to the percentage of waveform. The setting range of lower value and upper value is 1% ~ 99%, and the low value shall not be greater than the middle value and high value

Absolute: Set according to the vertical range. The absolute threshold value depends on the vertical scale, offset and probe attenuation. These values should be set before setting absolute thresholds. Lower and upper values are limited to the range of screen. If any absolute threshold is greater or less than the minimum or maximum waveform value, the measurement may be invalid.

19 Math

19.1 Overview

The SDS2000X Plus supports 2 math traces and multiple operators. Arithmetic operators: Addition (+), subtraction (-), multiplication (\times), division (/), average, eres, identity, negation; Algebra operators: differential (d/dt), integral ($\int dt$), square root ($\sqrt{\quad}$), absolute ($|y|$), sign, exp, exp10, ln, lg, interpolate; and FFT, as well as a formula editor. The math traces are labeled with an “F1” and “F2” icon and can be measured by the cursors or as the source of auto measurement.

Press the **MATH** button on the front panel, or touch **+** in the channel descriptor box region and select *Func1* or *Func2*, and then the math dialog box pops up.

- A. Select the math trace, F1 or F2
- B. Turn on or off the math operation
- C. Select the function. Touch the area to recall the function setting page, and select the source and operator
- D. Set the vertical scale of the math operation
- E. Set the label text of the math trace
- F. Set the vertical position of the math operation. The vertical scale and position of the math can also be set by knob, referring to "Vertical Setup"
- G. Enable/Disable invert, that is similar to the process used in "Vertical Setup".

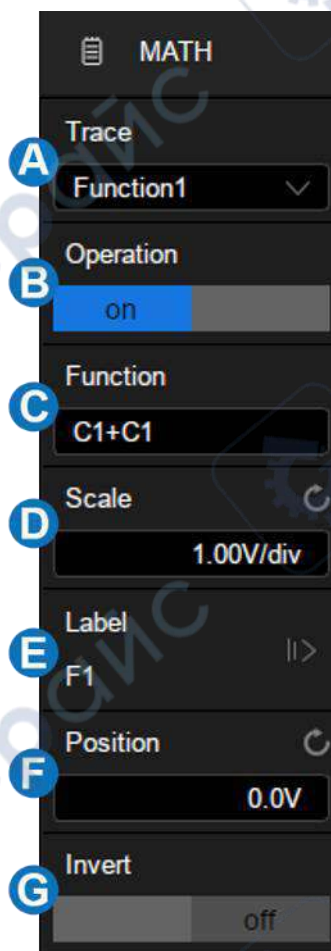

Units for Math Waveform

Different operations have different dimensions. Therefore, the specific units displayed in *Scale* depend on the operation:

Math Operation	Unit
Addition (+) or Subtraction (-)	V, A, or U* *(used when the units of two sources are not consistent)
Multiplication (x)	V ² , A ² , or W
Division (/)	None, Ω (Resistance unit Ohms), S (conductance unit Siemens)
FFT	dBVrms, Vrms, dBArms, Arms, dBm

d/dt	V/s (Volt/second) or A/s (A/second)
$\int dt$	VS (Volt*second) or AS (A*second)
$\sqrt{\quad}$	$V^{0.5}$ or $A^{0.5}$
y	V, A
Sign	V, A
Exp\Exp10	V, A
Ln\lg	V, A
intrp	V, A

19.2 Arithmetic

The SDS2000X Plus can perform arithmetic operations including addition, subtraction, multiplication or division on any two analog input channels. The values of Source A and Source B are computed point-by-point.

The following figure shows an example of $F1 = C1 + C2$:



19.2.1 Average

The oscilloscope accumulates multiple waveform frames and calculates the average as the result. If a stable trigger is available, the resulting average has a random noise component lower than that of a single-shot record. The more frames that are accumulated, the lower the noise is.

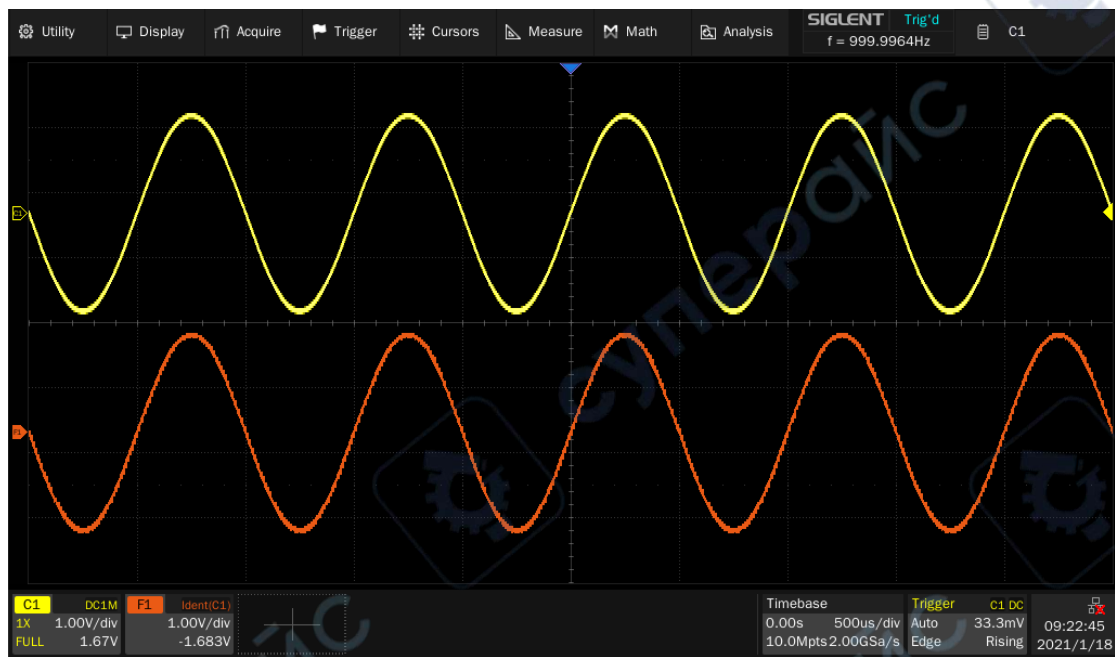

Note: Average acquisition is only valid for periodic signals, and it is important to ensure that the waveform is triggering in a stable way when using average mode.

19.2.2 ERES

The oscilloscope filters the sample, which rejects noise in the high-frequency domain, so the signal-to-noise ratio (SNR) is improved. As a result, the effective number of bits (ENOB) of the oscilloscope is enhanced.

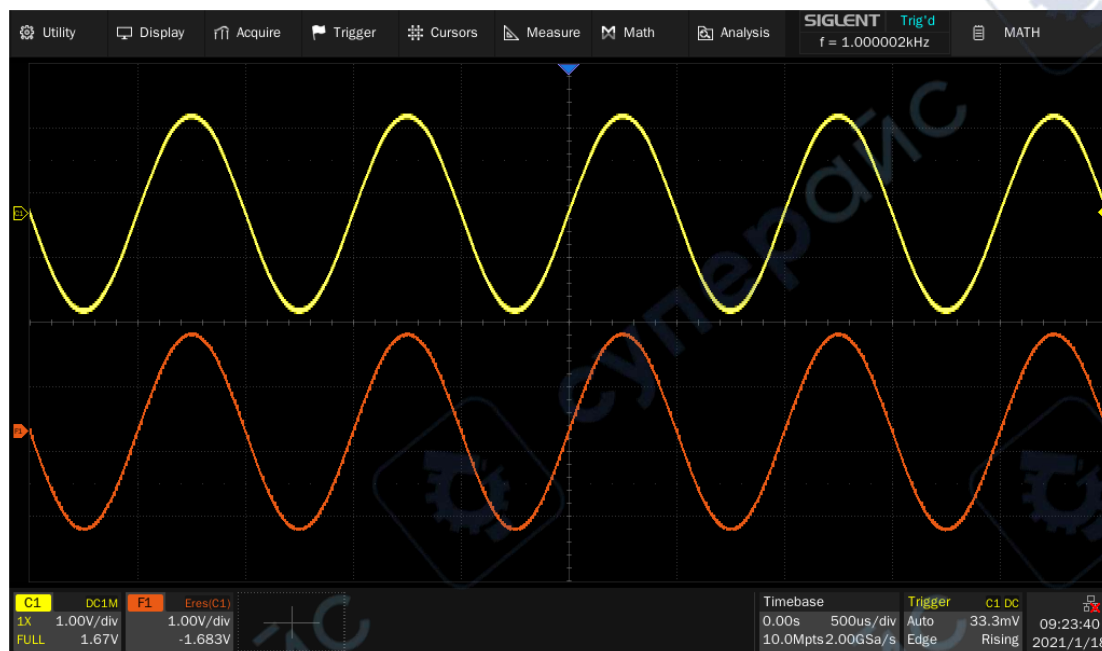

ERES operation does not require the signal to be periodic, nor does it require stable triggering, but due to the digital filtering, the system bandwidth of the oscilloscope will degrade when acquiring data in ERES mode. The higher the enhanced bits, the lower the bandwidth. The following table shows the relationship between ERES bits and bandwidth:

ERES Bits	-3dB bandwidth
0.5	0.25*Sample rate
1	0.115*Sample rate
1.5	0.055*Sample rate
2	0.028*Sample rate
2.5	0.014*Sample rate
3	0.007*Sample rate

19.3 Algebra

The SDS2000X Plus can perform algebra operations including differential (d/dt), integral ($\int dt$) and square root ($\sqrt{\quad}$)

19.3.1 Differential

The differential (d/dt) operator is used to calculate the derivative of the selected source. It is always used to measure the instantaneous slope of the waveform, such as the slew rate of an operational amplifier.

The differential equation is:

$$d_i = \frac{y(i + dx) - y(i)}{dx}$$

Where:

d = Differential result

y = Values of source data

i = Data point index

dx = Differential interval

The range of “dx” in the d/dt menu is 2[~]20. The measurement units are point and the corresponding time difference range is 0.02[~]0.20 div.

“div” indicates the number of the pixel points that each division has and is 100 for the SDS2000X Plus. If dx = 10 points, the time difference is:

$$0.01 * 10 = 0.1 \text{ div}$$

Then the differential operator calculates the “average slope in 10

points” of the selected source and dx represents the time difference between the 10 sampled points.

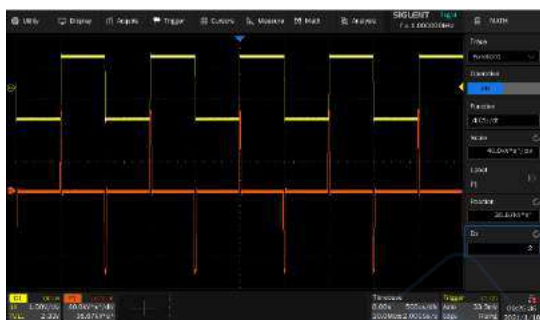

$dx = 2$



$dx = 6$

Note: Differentiation is sensitive to noise.

19.3.2 Integral

Integral operation integrates the waveforms on the screen or within the specified gate.

Setting *Offset* in the integral menu provides an approach to correct the DC offset of the source. Small DC offsets in the input signal (or even small offset errors of the oscilloscope itself) may cause the integral output waveform to “ramp” up or down, as shown below:

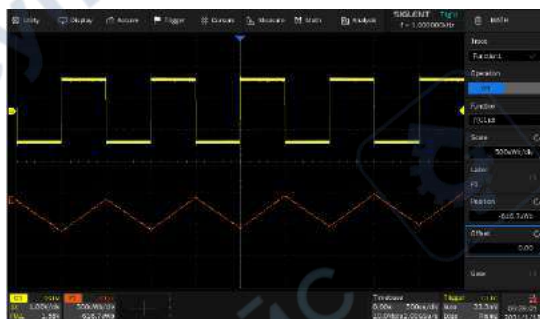

Integral without Offset

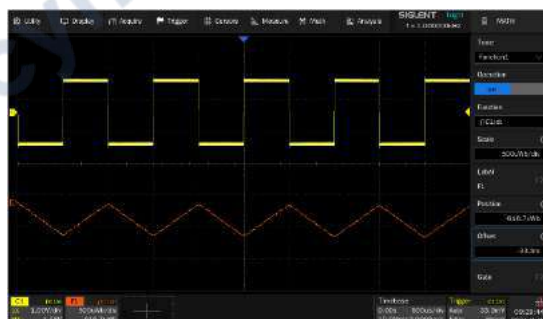

Integral with Offset

In addition, the integral operation can be performed within a specified gate. Touch *Gate* area in the math dialog box, and enable *Gate* function, then set *Gate A* and *Gate B* to define the gate. The setting of the gate cursors is similar to that of normal cursors. See "Select and Move Cursors" for details.



19.3.3 Square Root

Square root ($\sqrt{\quad}$) calculates the square root of the selected source. If the waveform value is negative (the waveform is below the ground level), the result is displayed as zero.

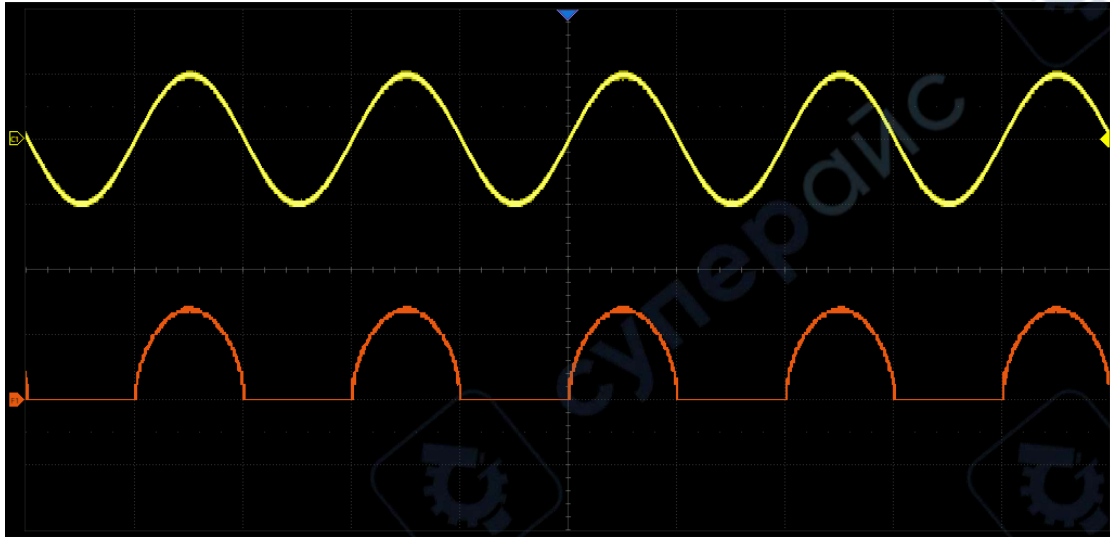

19.3.4 Absolute

Absolute ($|x|$) calculates the absolute value of the selected trace.

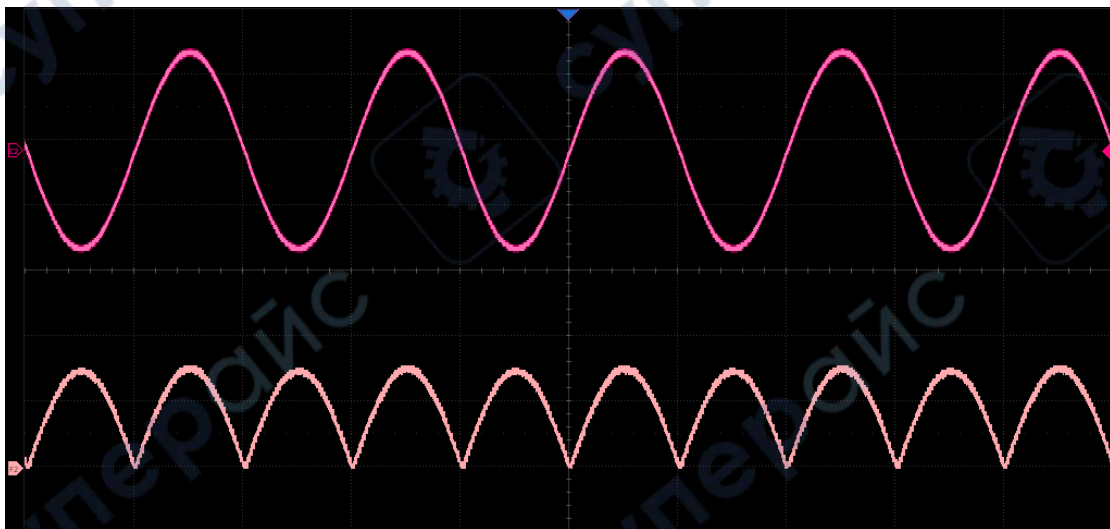

19.3.5 Sign

In mathematics, the sign function or signum function (from signum, Latin for "sign") is an odd mathematical function that extracts the sign of a real number.

The sign function of a real number x is defined as follows:

$$\begin{aligned}\text{Sign}(x) &= -1 && \text{if } x < 0, \\ &= 0 && \text{if } x = 0, \\ &= 1 && \text{if } x > 0.\end{aligned}$$

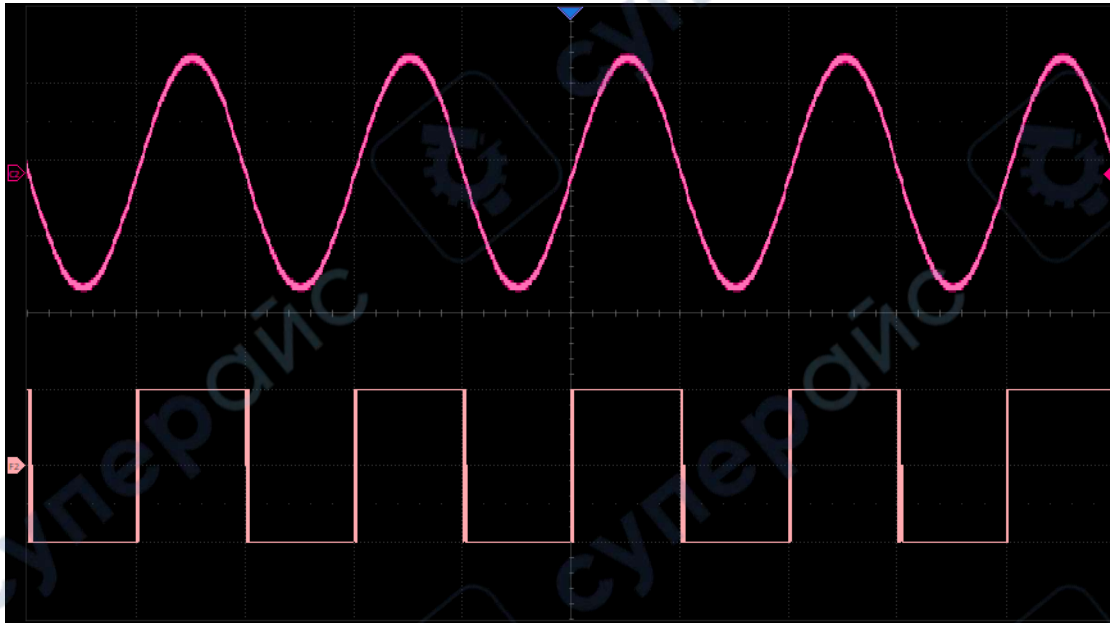

19.3.6 Exp/Exp10

The exponential operation includes the exponential operation e^x based on constant e and the exponential operation 10^x based on 10.

For example: $y(x) = e^x$.

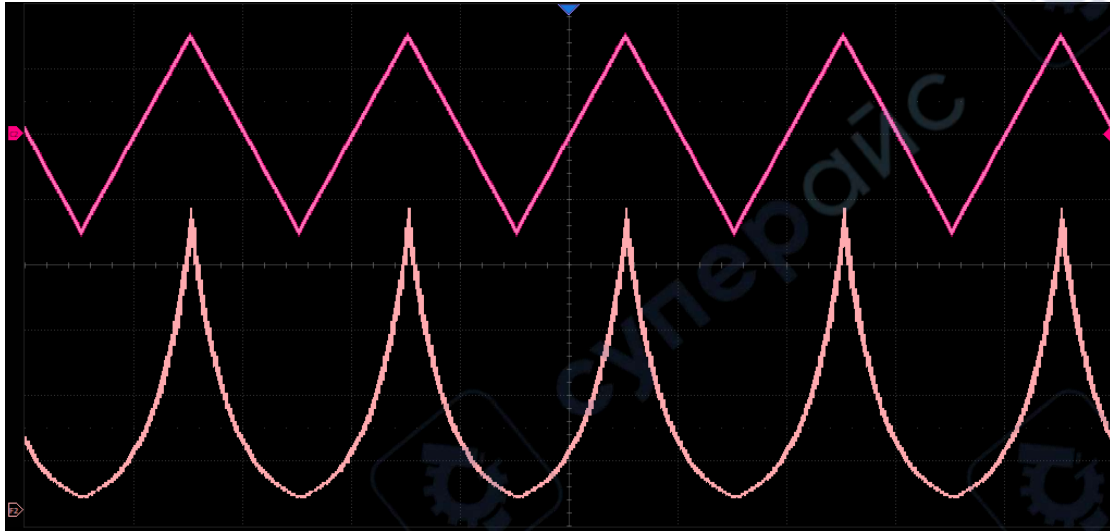

19.3.7 Ln/Lg

Logarithmic operation includes logarithm base e (\ln) and logarithm base 10 (\lg). In logarithmic operation, if the waveform value is negative (the waveform is below the ground level), the result is displayed as zero.

For example: $F1 = e^x$, where x is the trigonometric wave function. $F2 = \ln(F1)$.



19.3.8 Interpolate

Between the adjacent sampling points, the waveform is interpolated according to the selected interpolation method and interpolation coefficient. Touch *Acquire* > *Interpolation* to set the interpolation method, and the interpolation coefficient can be set to 2, 5, 10 or 20.



coefficient = 2

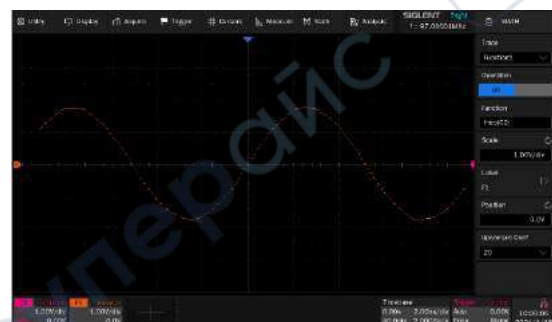

coefficient = 20

19.4 Frequency Analysis

The result of FFT (Fast Fourier Transform) calculations is the frequency spectrum of the source signal. The horizontal axis of the FFT display is labeled using frequency (Hz) units instead of time (seconds). In addition, the vertical axis provides the option of logarithmic scaling (dBVrms/dBArms or dBm). In this mode, the oscilloscope display is very similar to a spectrum analyzer.

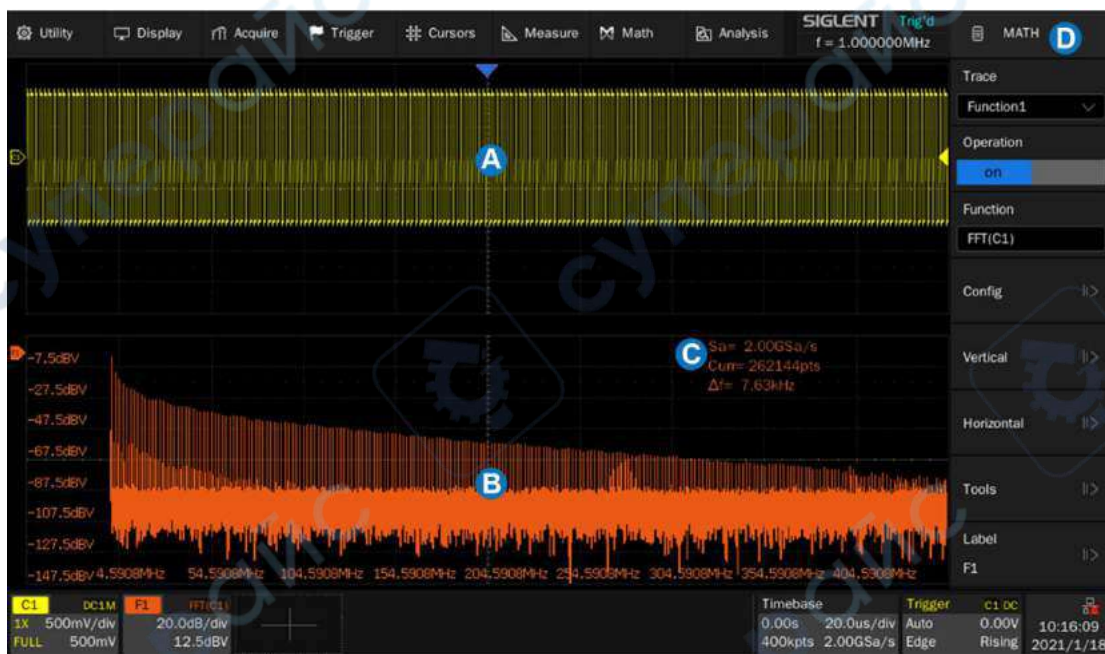

- Time-domain waveform display area
- Spectrum (FFT) waveform display area
- FFT parameter display area
- Dialog box

Parameter Display Area

The FFT parameters are displayed in the upper right of the spectrum

waveform display area:

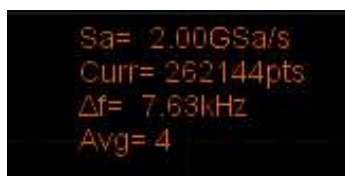

```
Sa= 2.00GSa/s
Curr= 262144pts
Δf= 7.63kHz
Avg= 4
```

- **FFT sample rate (Sa):** FFT operation results present the first Nyquist zone ($DC \sim Sa/2$) of the frequency spectrum. Be aware that the FFT sample rate may be inconsistent with the sample rate in the time domain. Assuming the max points is set to 2 Mpts:

- ✓ When the number of points in the time domain, N , is less than 2 Mpts, the FFT takes the number which is an integer power of 2 closest to N . In this case, the FFT sample rate = sample rate in the time domain.

- ✓ When N is greater than 2 Mpts, FFT first decimates N by D and then takes the first 2 Mpts for the calculation. In this case, the FFT sample rate = sample rate in time domain/ D .

For example, in the case of sample rate in the time domain is 1 GSa/s and the number of samples is 10 Mpts, the FFT first decimates the samples by 4, to 2.5 Mpts, and then takes the first 2 Mpts to calculate the spectrum. In this example, FFT sample rate = $1 \text{ GSa/s} \div 4 = 250 \text{ MSa/s}$.

- **FFT points (Curr):** The current FFT points, which is an integer power of 2, up to 2 M points (2097152, to be exact).
- **Frequency interval (Δf):** The frequency interval between two adjacent points in the FFT sequence, which is proportional to the frequency resolution.
- **Average count of FFT (Avg):** Displayed only when the FFT mode is set to "Average", indicating the completed average count.

Select *Operation* as FFT in the math dialog box and touch *Config* to recall the configuration dialog box:

- A. Set the maximum points (2^n , $n = 11 \sim 21$)
- B. Set the window type (Rectangle, Blackman, Hanning, Hamming, and Flattop)
- C. Automatically set vertical scale, reference level, center frequency, and horizontal scale according to the maximum frequency component in the previous frame
- D. Select the display mode (Split, Full Screen and Exclusive)
- E. Select the FFT mode (Normal, Average and Max-Hold)
- F. Set the average count in average mode
- G. Reset average
- H. Return to previous menu

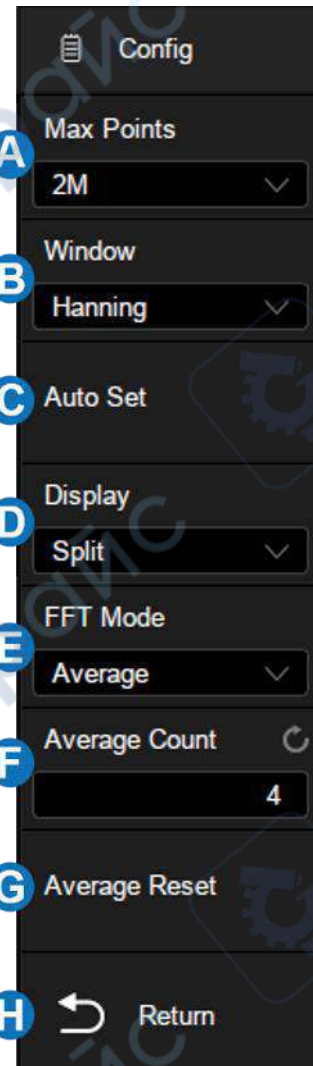

Windows

Spectral leakage in FFTs can be considerably decreased when a window is used. SDS2000X Plus provides five windows that have different characteristics and are applicable to different scenarios.

For example, for a two-tone signal with a very close frequency interval, it is suitable to use a Rectangle window with the best frequency resolution. For the case where the accuracy of amplitude measurement is critical, it is recommended to select the Flattop window with the best amplitude resolution.

Window	Characteristics	Main lobe width	Side lobe suppression	Maximum amplitude error
Rectangle	The best frequency resolution The worst amplitude resolution It is equivalent to the case of no window	$4\pi/N$	-13 dB	3.9 dB
Hanning	Better frequency resolution Poor amplitude resolution	$8\pi/N$	-32 dB	1.4 dB
Hamming	Better frequency resolution Poor amplitude resolution	$8\pi/N$	-43 dB	1.8 dB
Blackman	Poor frequency resolution Better amplitude resolution	$12\pi/N$	-58 dB	1.1 dB
Flattop	The worst frequency resolution The best amplitude resolution	$23\pi/N$	-93 dB	< 0.1dB

Display Mode

- **Split:** Time-domain waveform and frequency domain waveform are displayed separately. The time-domain waveform is on the upper half screen, while the frequency domain waveform is located within the lower half of the display. In Split mode, if Zoom is enabled, the zoomed waveform and the frequency domain waveform are displayed on the lower half screen together.
- **Full Screen:** Time-domain waveform and frequency-domain waveform are displayed together.
- **Exclusive:** Only the frequency-domain waveform is displayed.

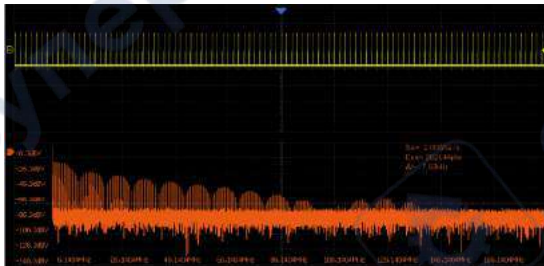

Split Mode, Zoom off

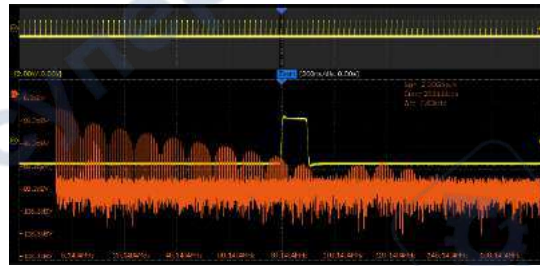

Split Mode, Zoom on

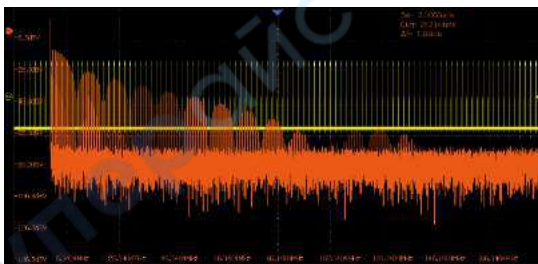

Full Screen Mode

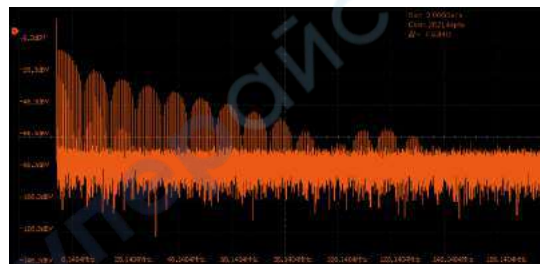

Exclusive Mode

FFT Mode

- **Normal:** Displays the FFT result of each frame directly.
- **Max-Hold:** Holds the maximum value in the historic frame on the display until cleared. This mode is suitable for detecting

discontinuous waves, such as sporadic pulse signals, or frequency hopping signals. Press the **Clear Sweeps** button on the front panel to clear the max-hold waveform.

- **Average:** Reduces the effect of the superimposed random noise on the signal. After the FFT mode is set as Average, *Average* will appear under *FFT Mode*. The average count can be set here, ranging from 4 to 1024. Press the **Clear Sweeps** on the front panel or touch *Reset* in the dialog box to restart the average counter.

Touch *Vertical* or *Horizontal* in the math dialog box to recall the FFT vertical or horizontal settings dialog box:

- Set the vertical scale and the reference level
- Set the unit (dBVrms, Vrms and dBm). When the unit is dBm, the oscilloscope will automatically calculate the dBm value based on the *Ext Load* value set in **C** area
- Set the external load, which is used to calculate the correct dBm result
- Return to previous menu
- Set the center-span frequencies
- Set the start-end frequencies

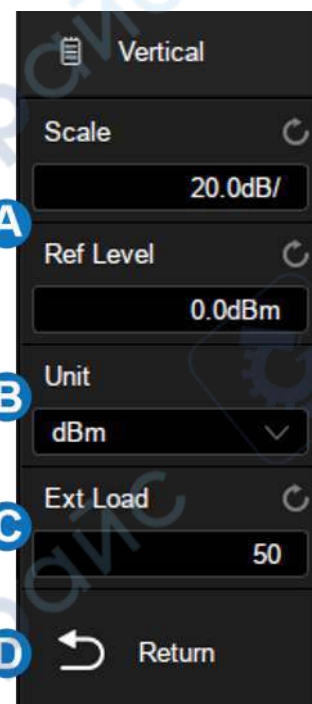

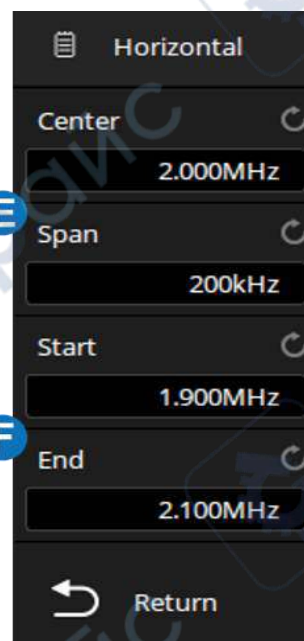

Unit

The unit of the vertical axis can be set to dBm, dBVrms or Vrms. dBVrms and Vrms respectively using either logarithmic or linear scaling. dBVrms is recommended to show larger dynamic ranges. dBm is a power unit, the correct result can be obtained only if the value of *Ext Load* is set to be consistent with the load impedance of the actual measured signal.

Vertical Control

Touch *Ref Level* to set the reference level of FFT waveform by the universal knob or the virtual keypad. It can also be set by the offset knob shared by Decode, Digital, Math, and Ref on the front panel.

Touch *Scale* to set the vertical scale of FFT waveform by the universal knob or the virtual keypad. It can also be set by the scale knob shared by Decode, Digital, Math, and Ref on the front panel. The reference

point for vertical scale scaling is the reference level.

Horizontal Control

Touch **Center** to set the center frequency by the universal knob or the virtual keypad. Touch **Span** to set the frequency span by the universal knob or the virtual keypad.

Touch **Start** to set the start frequency by the universal knob or the virtual keypad.

Touch **End** to set the end frequency by the universal knob or the virtual keypad.

The relationship between Center, Span, Start and End is:

$$\text{Center} = (\text{Start} + \text{End})/2$$

$$\text{Span} = \text{End} - \text{Start}$$

FFT Tools

The SDS2000X Plus provides two tools for FFT waveform: Peaks and Markers. The peaks tool can automatically search the qualified peak points and mark them on the FFT waveform. Up to 10 peaks are supported. Based on the peak tool, the markers tool can automatically search the qualified harmonics, and users can control the position of each marker. Up to 8 markers are supported.

Touch **Tools** in the math dialog box to recall the FFT tools dialog box:

When the FFT tool type is set to peaks, the dialog box is as follows:

- A. Turn on or off the table. Turn on the table, the peaks searched with the limit of **D** *Search Threshold* and **E** *Search Excursion* will be displayed in table
- B. Turn on or off the display of peak frequency in the table
- C. Sort peaks by amplitude or frequency
- D. Set the search threshold. Only peaks larger than the limit are shown
- E. Set the difference between the peak value and the minimum amplitude on both sides. The difference should be greater than the search excursion
- F. Return to previous menu

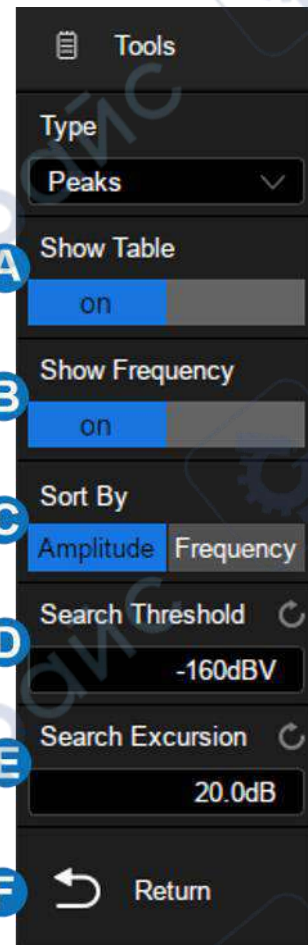

When the FFT tool type is set to markers, the dialog box is as follows:

- A. Control markers. Touch to control the display and position of each marker
- B. Marker on peaks. It will automatically mark the peak that meets the conditions of *Search Threshold* and *Search Excursion*
- C. Marker on harmonics. It will automatically mark each harmonic of FFT waveform
- D. Turn on or off the table
- E. Turn on or off the frequency display
- F. Turn on or off the delta display
- G. Set the search threshold. Only peaks larger than the peak limit can be judged as peaks
- H. Set the difference between the peak value and the minimum amplitude on both sides. The difference should be greater than the search excursion, which can be determined as the peak
- I. Return to previous menu

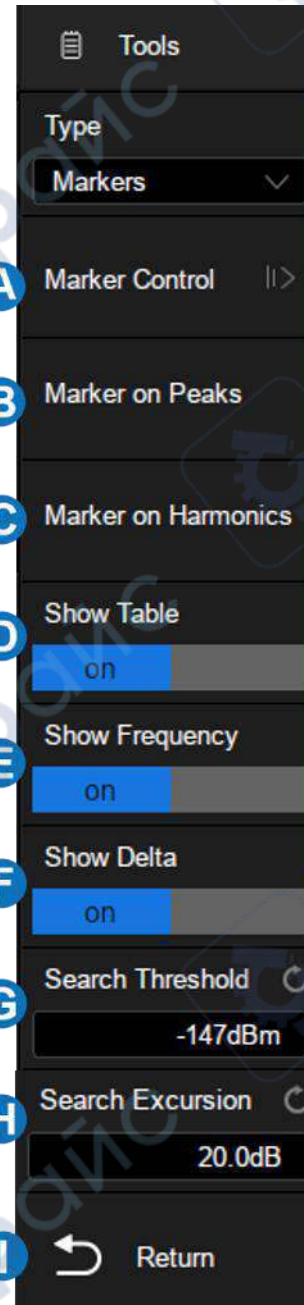

Note: The FFT dialog box is longer than the display. Slide the dialog box area up and down by gestures, or scroll the mouse wheel to the

view non-displayed areas.

The following shows the peak tool enabled for an FFT waveform:



Measure the FFT waveform

Press the **Cursors** button on the front panel to turn on the cursor function, and then specifying the source as "Math". X1 and X2 cursors can be used to measure the frequency value at the cursor position.

Only the maximum parameter of the FFT is supported in automatic measurement.

Note: DC components in the signal may show a large amplitude near 0 Hz. If your application does not require measurement of the DC component, it is recommended to set the coupling mode of the source channel to "AC".

19.5 Formula Editor

Touch *Formula Editor* in the operation setting page to recall the editor:

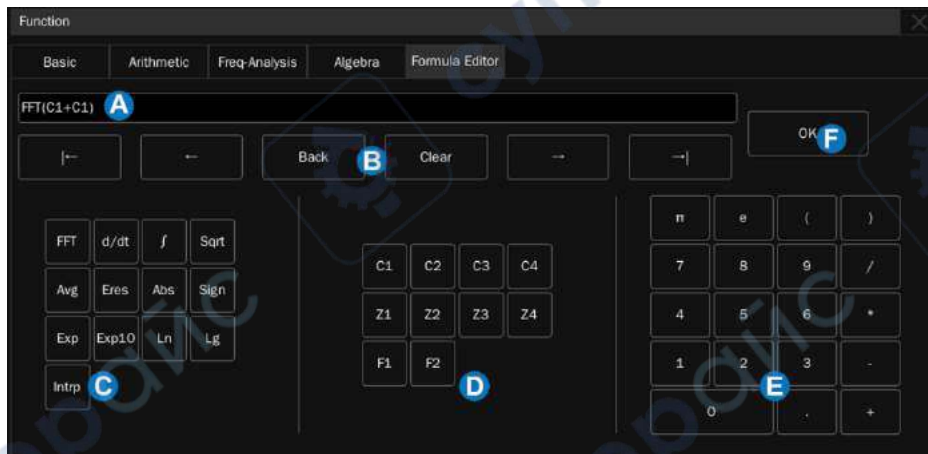

- A. Formula display text box
- B. Text box operation area, which can clear and modify the entered formula
- C. Special operators
- D. Operation source. **Cx** represents analog traces, **Zx** represents zoomed traces and **Fx** represents math traces
- E. Keyboard area, which contains the basic arithmetic operators addition (+), subtraction (-), multiplication (*), division (/)
- F. Confirm button. After the formula is input, press the button to apply it

The following is an example of $F1 = (C1 + C1) * C2$ through the formula editor



20 Reference

Data from analog channels or math can be saved to the reference locations (REFA/REFB/REFC/REFD) in the built-in non-volatile memory. The saved reference waveform can be recalled to be compared with the current waveform.

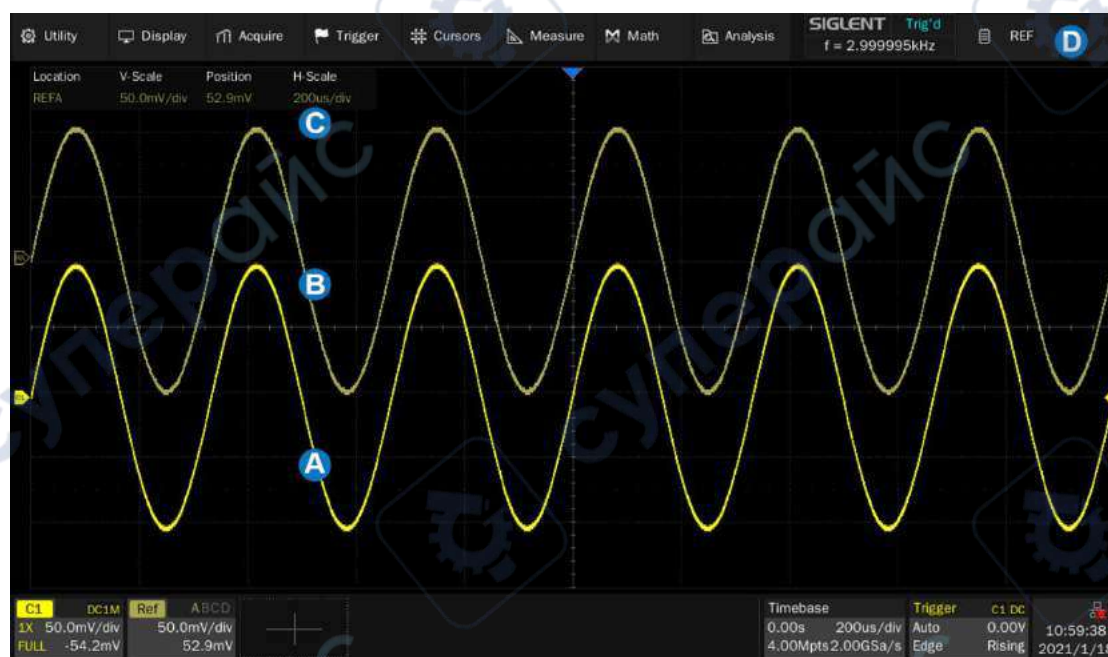

- Channel waveform
- Reference waveform
- Reference vertical and horizontal information display area
- Reference dialog box, hidden in this figure

Press the **Ref** button on the front panel, or touch **+** in the descriptor box region and select *Ref* to recall the ref dialog box.

- A. Select the location of the reference (REFA/REFB/REFC/REFD)
- B. Select the source (C1~C4 and MATH)
- C. Enable/disable Display of the reference waveform
- D. Set the label text of the reference trace.
- E. Save the specified waveform in **B** to the specified location in **A**

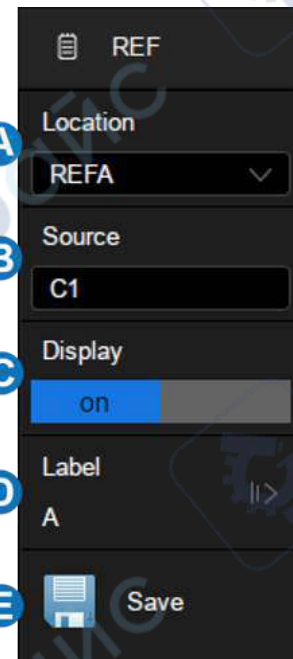

Adjust the Reference Waveform

Set the vertical position of the reference waveform by the offset knob shared by Decode, Digital, Math, and Ref on the front panel, and set the vertical scale of the reference waveform by the scale knob.

21 Search

The SDS2000X Plus can search for the specified events in a frame. The location of the qualifying events are indicated by white triangle indicators along the top of the display. In YT mode or Roll mode with the acquisition stopped, up to 1000 events are supported. In Roll mode with acquisition set to run, the number of search events is unlimited. The waveform can be zoomed when the search function is enabled.

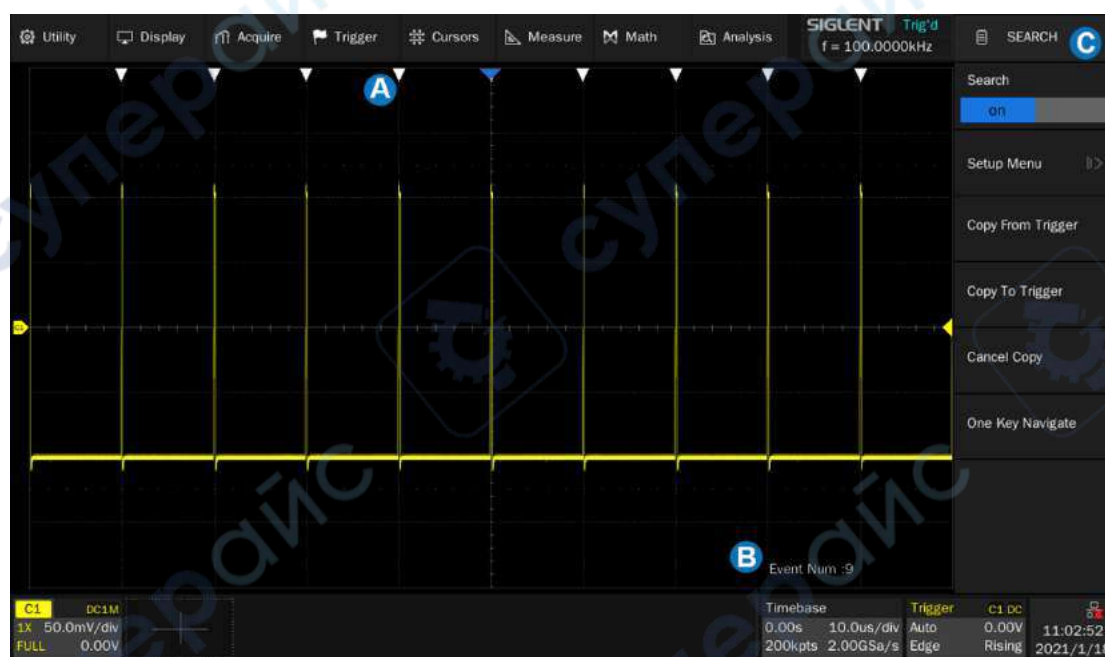

- A. Search event indicator, marking the time point of an event
- B. Total number of events marked on the display
- C. Search dialog box, hidden in this example

In the stop state, the area **B** shows the index of the current event /total number of events. The current event is the one in the center of the display.



Press the **Search** button on the front panel or touch the menu **Analysis>Search** to recall the search dialog box and turn on it.

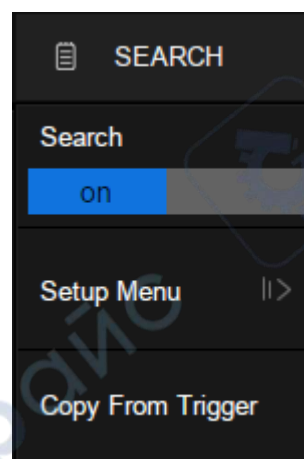

Setup Menu

Select and set the search type in the **Setup Menu**. The SDS2000X Plus provides five search conditions: Edge, Slope, Pulse, Interval and Runt.

Search Type	Setup Description
Edge	Slope: Rising, Falling, Either

Slope	Slope: Rising, Falling Limit Range setting is available
Pulse	Polarity: Positive, Negative Limit Range setting is available
Interval	Slope: Rising, Falling Limit Range setting is available
Runt	Polarity: Positive, Negative Limit Range setting is available

Search setup is similar to the corresponding trigger type. See the sections “ Edge Trigger”, “ Slope Trigger”, “ Pulse Trigger”, “ Interval Trigger” and “ Runt Trigger” for details.

Copy

The SDS2000X Plus supports replication between search settings and trigger settings.

- **Copy from Trigger:** Synchronize the current trigger settings to the search settings.
- **Copy to Trigger:** Synchronize the current search settings to the trigger settings.
- **Cancel Copy:** Cancel the last synchronization and restore the settings before it.

Note: When performing a copy from trigger, if the trigger type is not supported by search, the operation is invalid.

22 Navigate

Press the **Navigate** button on the front panel or touch the menu **Analysis** > **Navigate** to recall the navigate dialog box. The SDS2000X Plus provides three navigate types: Search Event, Time and History Frame.

Navigate by Time

The oscilloscope automatically adjusts the trigger delay according to the direction set by the user.

Touch **Type** in the navigate dialog box to select the navigate type as “Time”.

There are two ways to navigate by time:

- Touch the **Time** area to set the time value by the universal knob or the virtual keypad.
- Press the navigation buttons ◀■▶ on the front panel to play backward, stop, or play forward the waveform. Press the ◀ or ▶ buttons multiple times to speed up the playing. Three speed levels are supported: Low Speed, Medium Speed and High Speed.

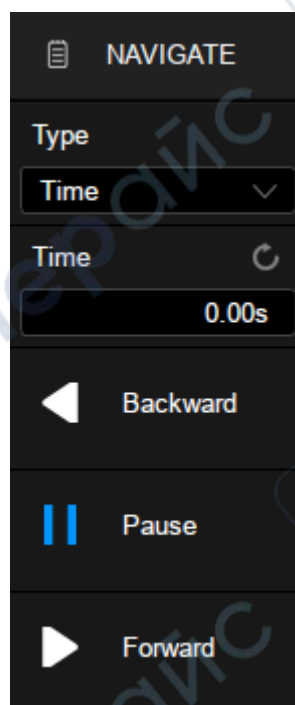

Navigate by Search Event

When the Search function is turned on and the acquisition is stopped, Navigate is usable to find search events (see the chapter "Search" for search function).

Touch *Type* in the navigate dialog box to select the navigate type as "Search Event".

Touch *Event Num* to set the event number by the universal knob or the virtual keypad. Press the navigation buttons ◀ or ▶ on the front panel to go to the previous or next search event.

Touch *Playing Mode* to set the search event playing mode.

Touch *Interval Time* to set the playing interval by the universal knob or the virtual keypad.

Touch the *Event List Switch* area to turn on or off the list. The list contains time labels for each event. Touching a row in the list

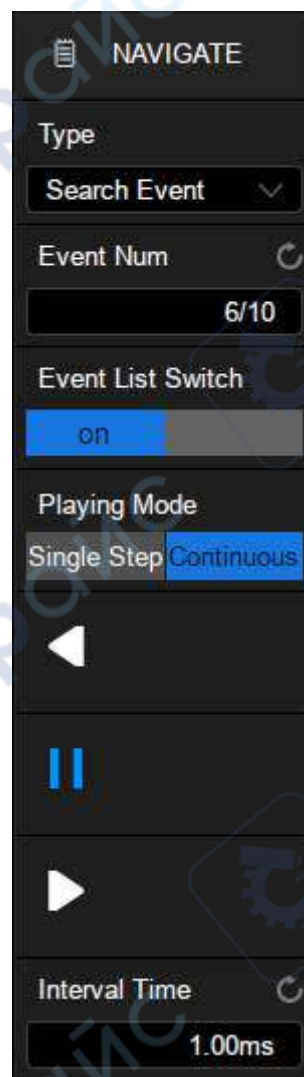

automatically jumps to the corresponding event. This operation is equivalent to specifying an event in the *Event Num* area.



Navigate by History Frame

When the history function is turned on, Navigate can be used to play history frames (see the chapter "History" for details of history function).

Touch *Type* in the navigate dialog box to select the navigate type as "History Frame".

Touch *Frame* to set the frame number by the universal knob or the virtual keypad. Press the navigation buttons ◀■▶ on the front panel to play backward, stop, or play forward.

Touch *Playing Mode* to set the search event playing mode.

Touch *Interval Time* to set the playing interval by the universal knob or the virtual keypad.

Touch *Stop On Search Event* to set the stop play condition: stop when the event is searched. This setting is only valid when the search function is on.

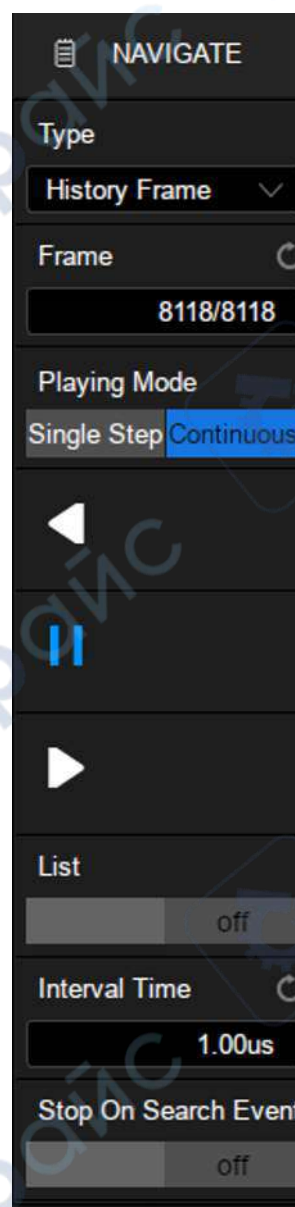

The following is an example of an occasional runt signal to demonstrate how to quickly locate and find events of interest by using the combination of Search and Navigate:

The input signal is a 2 V periodic square wave, in which every 10ms there is a dwarf pulse with a height of 1/3 of the normal amplitude:

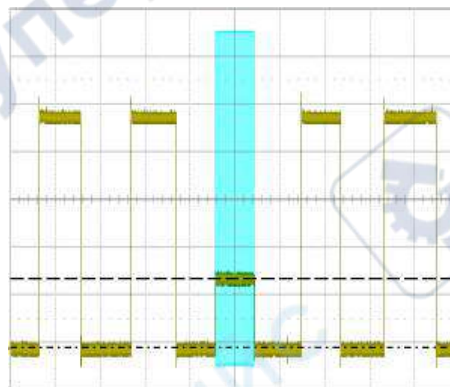

First, set the trigger type to Runt to trigger on the dwarf pulse. See the section “Runt Trigger” for details.

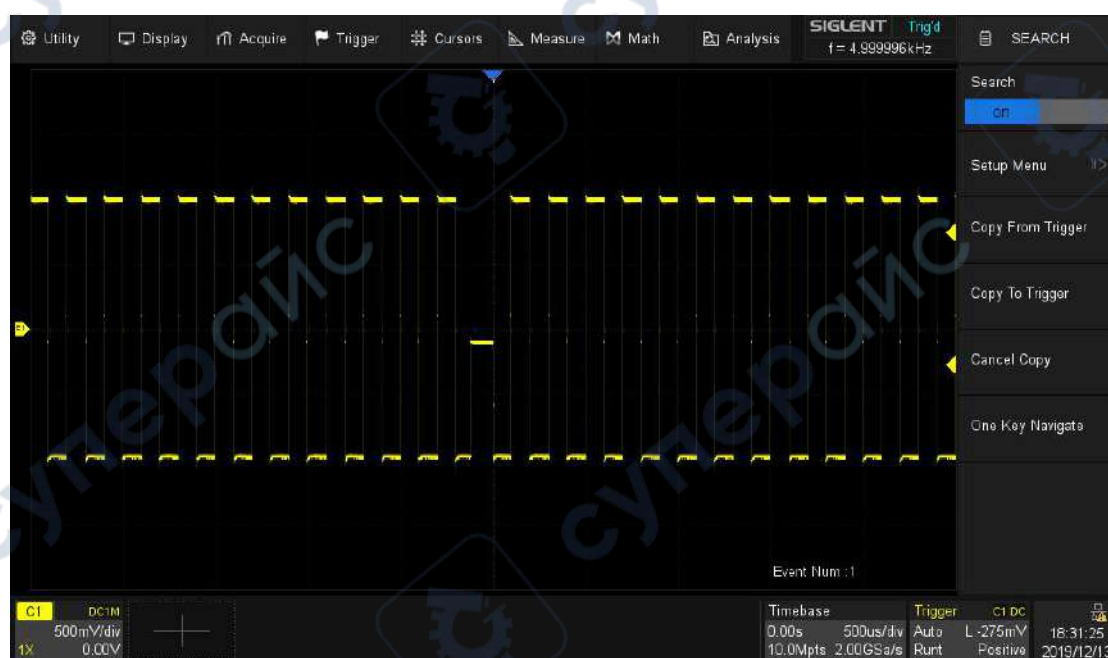

Then turn on the Search function and operate *Copy from Trigger* in the search dialog box so that the oscilloscope searches for the dwarf pulses according to the same setting as the trigger.

Set the horizontal scale to 10 ms/div, then 9 markers with ~ 10 ms interval are shown on the display, indicating that a total of 9 dwarf pulses were found in the full screen of 100 ms time range:

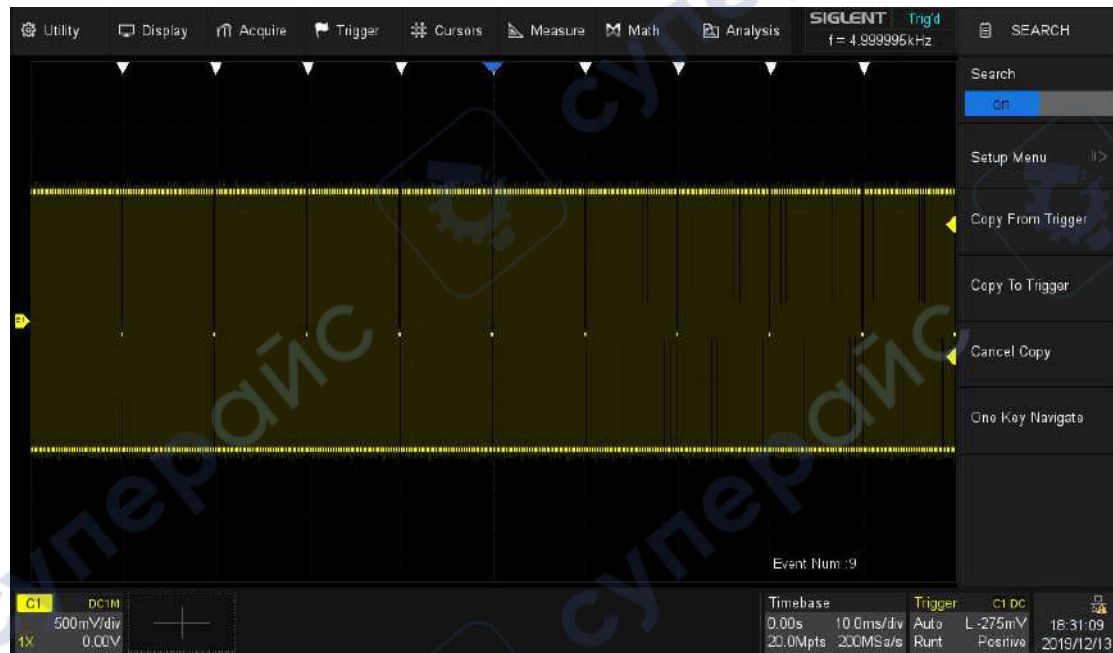

Turn on Zoom function to observe the full view of the frame and the detail of the third dwarf pulse at the same time:

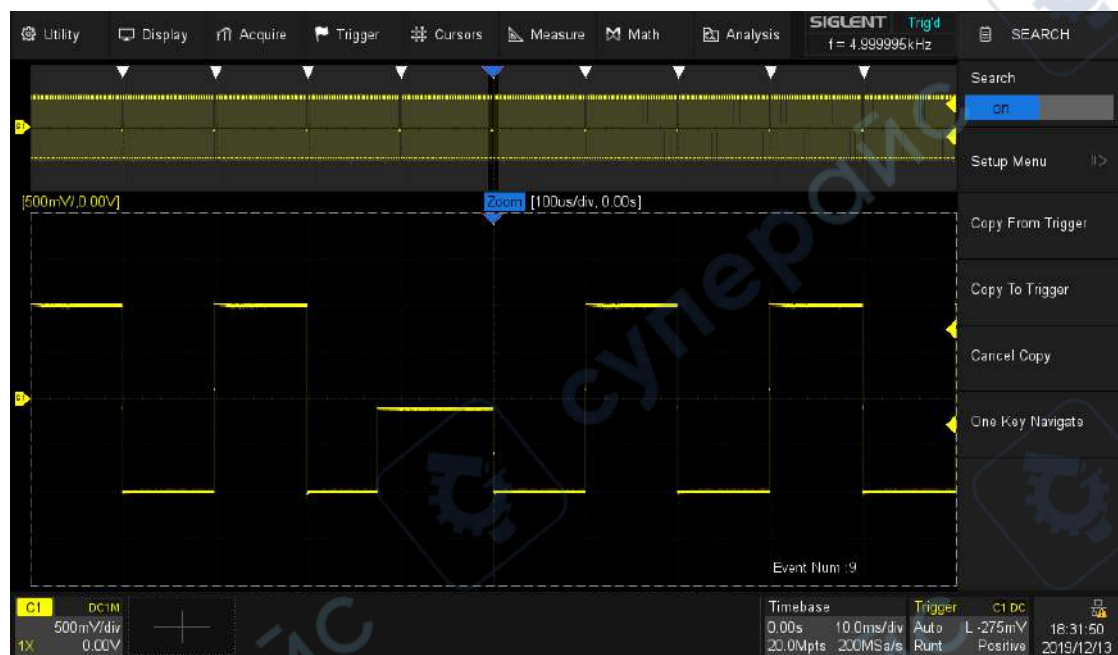

Press the **Run/Stop** button on the front panel to stop the acquisition, and then follow the steps **Navigate** > **Type** to select “Search Event”. The following figure shows the first dwarf pulse. In this example, the list is enabled and time labels of each event are shown in the list.

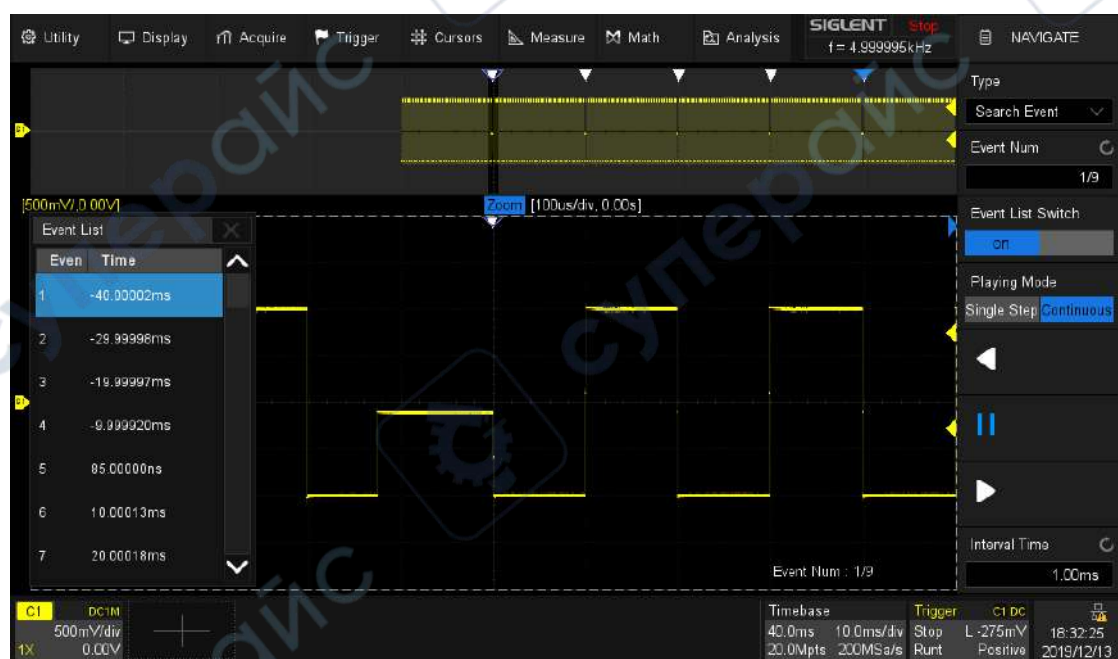

23 Mask Test

23.1 Overview

Users can create masks and define the rule used to evaluate Pass/Fail operations. An event violating the rule is defined as a failure and a pulse can be generated from the "Aux Out" port on the back panel. This is very useful to find and quantify anomalies in production tests or similar batch measurements. When Pass/Fail is enabled, the signal output from the Aux Out is automatically switched to Pass/Fail pulse.



- A. Mask area in green. Any dot violating the rule is highlighted in red, instead of the normal waveform color.
- B. Pass/Fail information display area, including the count of the passing frames, failed frames, total frames, and the fail rate.
- C. Dialog box

Perform *Analysis* > *Mask Test* to open the Mask Test dialog box:

- A. Turn on/off the test
- B. Select the source (C1~C4)
- C. Select the rule (All In, All Out, Any In and Any Out)
- D. Set the mask
- E. Turn on/off the Pass/Fail operation. Turning off the operation when the test is in progress will stop the test immediately, and the counters in the information display area will stop. Turn on the operation again re-starts the test and all the counters are cleared. Pressing the Clear Sweeps button on the front panel is equivalent.
- F. Turn on/off the information display
- G. Turn on/off “Stop on Fail”. When it is “on”, the oscilloscope stops the acquisition once it detects a failure
- H. Turn on/off “Failure to History”. When it is “on”, the failure frame will be stored to history buffer
- I. Turn on/off “Capture on Fail”. When it is “on”, the screenshot with the failure frame will be stored automatically.
- J. Turn on/off the sound prompt when a failure occurs.

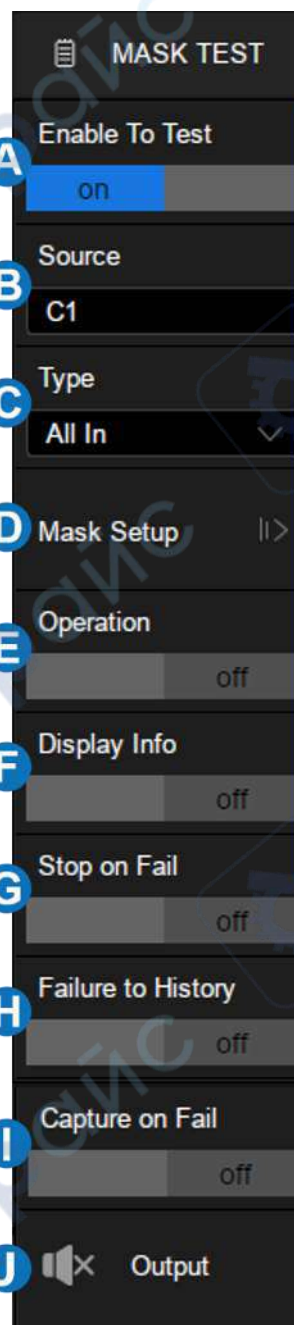

23.2 Mask Setup

Touch *Mask Setup* in the Mask Test dialog box to set the mask. There are two methods to create a mask, one is by setting horizontal and vertical values, and the other is by drawing a polygon mask.

- A. Create a mask automatically according to the waveform
- B. Create a custom mask using the Mask Editor tool
- C. Specify the location of the mask to be loaded
- D. Load the mask from the location specified at **C**
- E. Return to previous menu

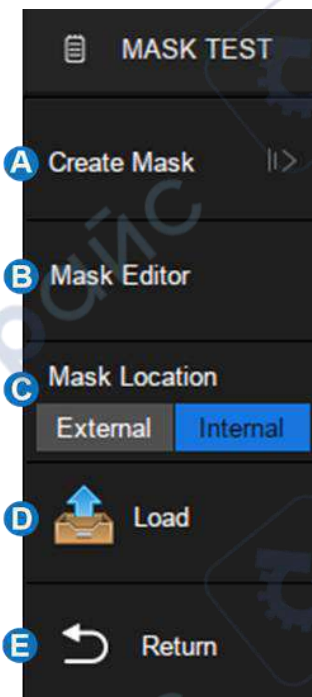

23.2.1 Create Mask

The mask can be created based on an existed waveform trace.

- Set the spacing of the mask to the trace in horizontal, with the unit of division
- Set the spacing of the mask to the trace in vertical, with the unit of division
- Create the mask based on settings in **A** and **B**
- Specify the location of the mask to be saved
- Select number of internal locations, optional 1~4
- Save the mask to the location specified at **D**
- Return to previous menu

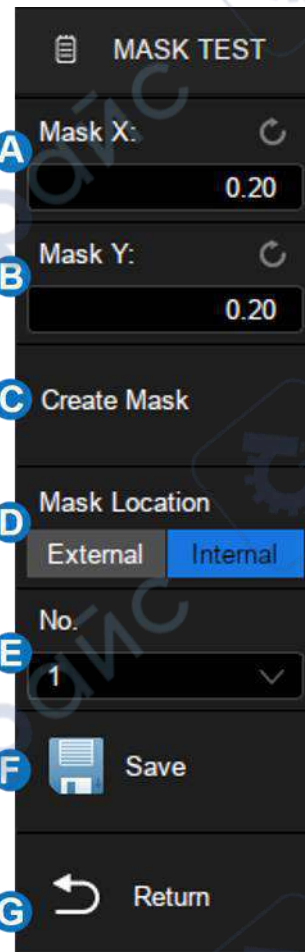

Set the values for *Mask X* and *Mask Y* (in divisions of display graticule), and then perform *Create Mask* to generate the mask. The horizontal and vertical adjustment range is 0.08~4.00 div.

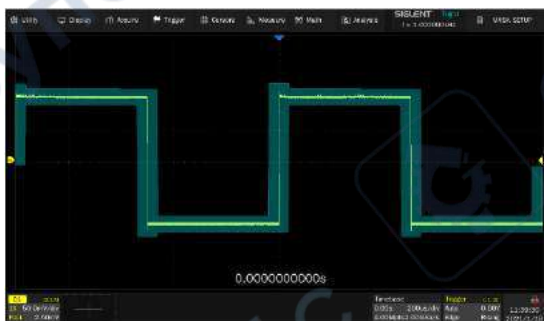

X = 0.2 div, Y = 0.2 div

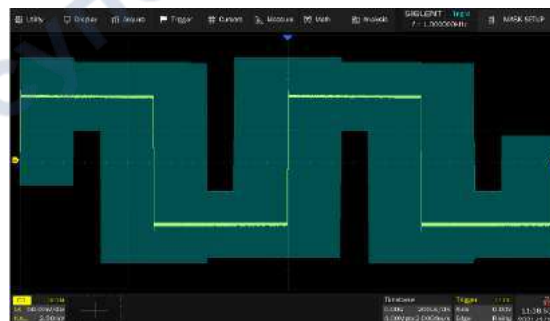

X = 1 div, Y = 1 div

Saving and recalling mask files (*.msk) is similar to the operation of setup files, see the chapter "Save/Recall" for details.

23.2.2 Mask Editor

The Mask Editor is a built-in tool that provides an approach to create custom masks. Below is its layout:

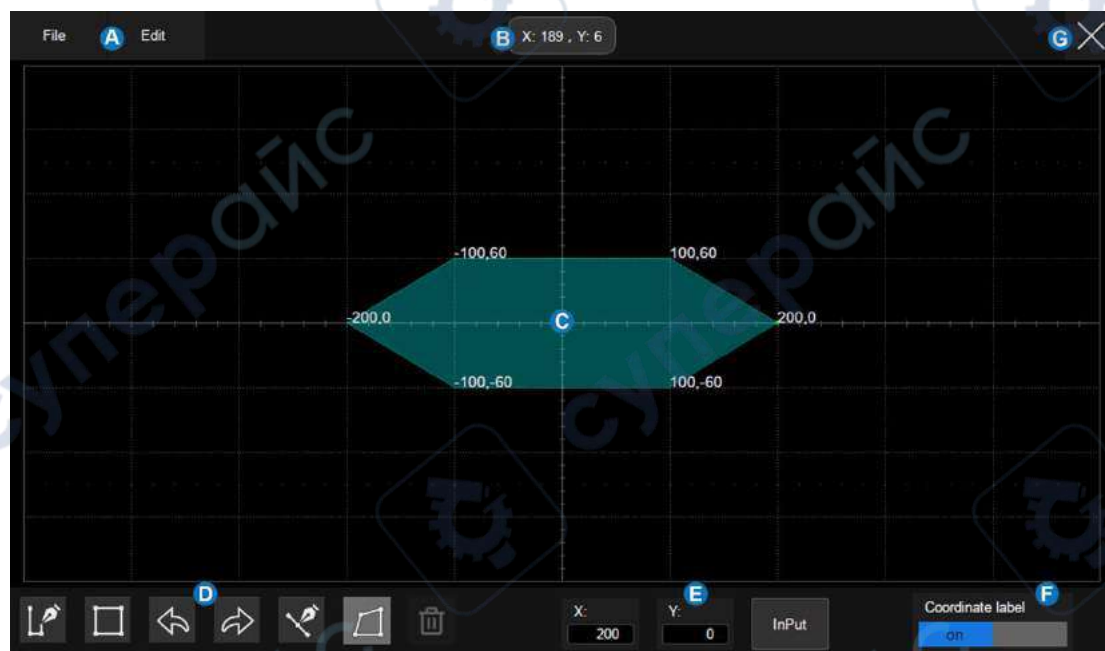

- A. Menu bar
- B. Coordinate of the latest touched point on the display
- C. Mask edit area, which is equivalent to the grid area. In this example, a hexagon has been created as a part of the mask
- D. Toolbar
- E. Coordinate edit area. Set the X ordinate and Y ordinate by the virtual keypad and then touch the "Input" button to perform the ordinate update

- F. Display or hide coordinate of polygon vertices on the display
- G. Exit the tool

Menu bar







There are 2 menus on the menu bar. The File menu includes ordinary file operations such as:

- **New:** Create a new mask file
- **Open:** Open an existed mask file
- **Save:** Save the current mask file
- **Exit:** Exit the Mask Editor tool

Note: The mask file created by the “Create Mask” cannot be recalled by the Mask Editor.

The contents of the Edit menu are equivalent to the Toolbar.

Toolbar

-  **Draw:** Creates vertices of a polygon by touching the display or entering values in **E** coordinate edit area
-  **Create Polygon:** Creates a polygon based on the drawn vertices by the operation Draw
-  **Undo**
-  **Redo**
-  **Insert Point:** Inserts a vertex on a selected side
-  **Edit Polygon:** Edits a polygon. Vertices, sides and the polygon

are all editable objects

-  **Delete Polygon:** Deletes selected polygon

To edit a vertex, side or polygon object, firstly select it, and then move it by a dragging gesture or by entering the desired value in **E** coordinate edit area. For a side, the value is for its middle point. For a polygon, the ordinate is for its geometric center.

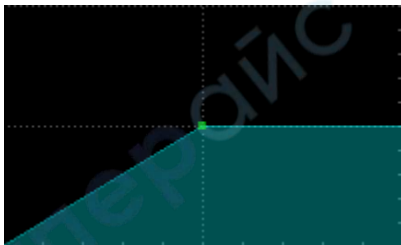

Select a vertex (point)

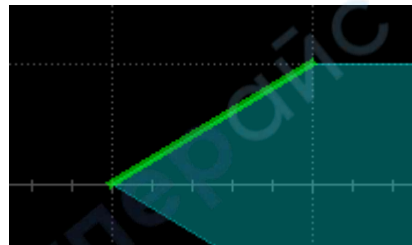

Select a side (line segment)

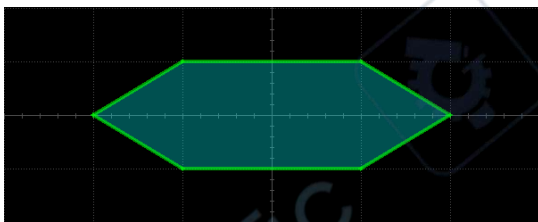

Select a polygon

23.3 Pass/Fail Rule

The Pass/Fail rule is specified at the **Type** region in the Mask Test dialog box.

- **All In:** All data points must be inside the mask to pass the test. Even a single point outside the mask will cause a failure.

- **All Out:** All data points must be outside the mask to pass the test. Even a single point inside the mask will cause a failure.
- **Any In:** Any data point inside the mask will be recognized as a pass. All data points outside the mask will cause a failure.
- **Any Out:** Any data point outside the mask will be recognized as a pass. All data points inside the mask will cause a failure.

23.4 Operation

Touch *Operation* to start/stop the test. Stopping a test in progress and restart the test will clear the count of the passing frames, failed frames, total frames, and the fail rate. Pressing the **Clear Sweeps** button on the front panel can also clear the count information.

24 Counter

24.1 Overview

The counter is used to measure the frequency and period of a signal or count the events happening within it. The counter is asynchronous to the acquisition system of the oscilloscope. It can work well even if the acquisition of the oscilloscope is stopped (indicated by a red-colored Run/Stop button)

Touch the menu *Analysis* > *Counter* to open counter dialog box:

- A. Turn on or off Counter
- B. Select the mode: frequency, period and totalizer
- C. Select the source (C1~C4)
- D. Set the level of the counter
- E. Turn on or off statistics
- F. Clear and restart the statistics.

Pressing the **Clear Sweeps** button on the front panel has an equivalent effect

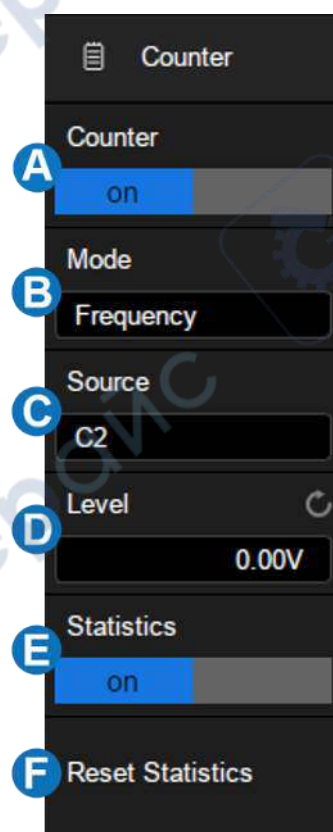

Mode

See section “Mode” for details.

Statistics

When statistics are enabled, the counter will increment the data and display the statistics results on the screen.

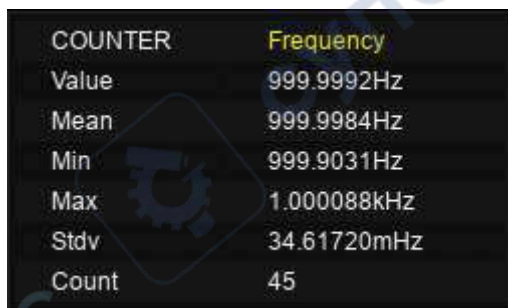

COUNTER	Frequency
Value	999.9992Hz
Mean	999.9984Hz
Min	999.9031Hz
Max	1.000088kHz
Stdv	34.61720mHz
Count	45

Value - The latest count

Mean - The average of all historical counts

Min - The minimum of all historical counts

Max - The maximum of all historical counts

Stdv - The standard deviation of all historical counts, used to judge the distribution of historical count parameters

Count - Number of counts obtained

Press the **Clear Sweeps** button or touch *Reset Statistics* in the measure dialog box to clear and restart statistics.

24.2 Mode

The counter provides 3 modes. Touch *mode* in the counter dialog box to open the mode selection window:

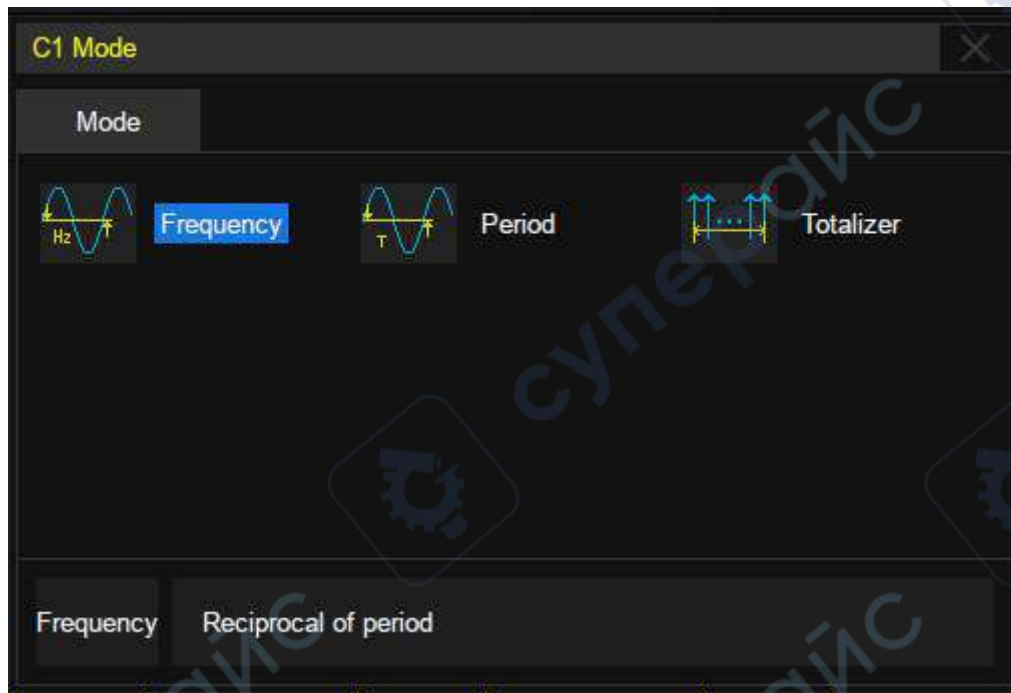

- **Frequency:** Average frequency over a period of time
- **Period:** The reciprocal of the average frequency over a period of time
- **Totalizer:** Cumulative count

When the mode is set to totalizer, the edge of the counting source needs to be set. When the counting gate is turned on, the counter can count only when the gate-source meets the specified conditions. Touch **Gate Setting** to recall the gate setting dialog box:

- A. Turn on or off the gate
- B. Select the gate type: Level or After Edge
- C. Gate source display area. C1 and C2 are gate sources of each other, C3 and C4 are gate sources of each other
- D. When the gate type is level, set the polarity (Positive or Negative) of the gate-source. When the gate type is edge, set the slope (Rising or Falling edge) of the gate source.
- E. Set the gate level
- F. Return to previous menu

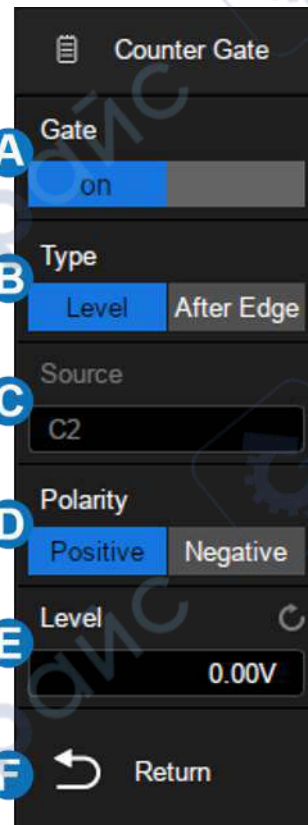

25 Power Analysis

25.1 Overview

The SDS2000X Plus supports a power analysis function. Power analysis can help users quickly and easily analyze and debug switching power supply designs. It automatically calculates Power Quality, Current Harmonics, Inrush Current, Switching Loss, Slew Rate, Modulation, Turn On/Turn Off, Transient Response, PSRR, Power Efficiency, Output Ripple, etc. Full use of the Power analysis requires an SDS2000X Plus oscilloscope, a differential voltage probe like the SIGLENT DPB series, a current probe like the SIGLENT CP series, the SIGLENT DF2001A deskew fixture, and the power analysis activation license (part number SDS_2000XP_PA). Install the software option part number SDS_2000XP_PA to permanently enable the power analysis function. Please refer to the section "Install Option" for installation and activation instructions.

Touch *Analysis*>*Power Analysis* to recall power analysis dialog box:

- A. Enable/Disable the test
- B. Select the analysis item (Power Quality, Current Harmonics, Inrush Current, Switching Loss, Slew Rate, Modulation, Turn On/Turn Off, Transient Response, PSRR, Power Efficiency, Output Ripple, etc.)
- C. Turn on/off the state of the

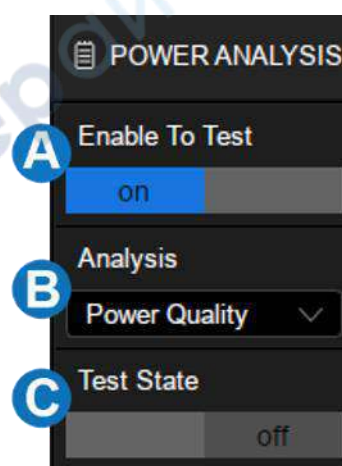

analysis item

25.2 Power Quality

The specific measurement parameters of power quality analysis include active power, apparent power, reactive power, power factor, power phase angle, voltage effective value, current effective value, voltage crest factor and current crest factor of power input of a switching power supply.

Type

Power—includes all the items to describe energy flow in a system: Active power, reactive power, apparent power, power factor and power phase angle.

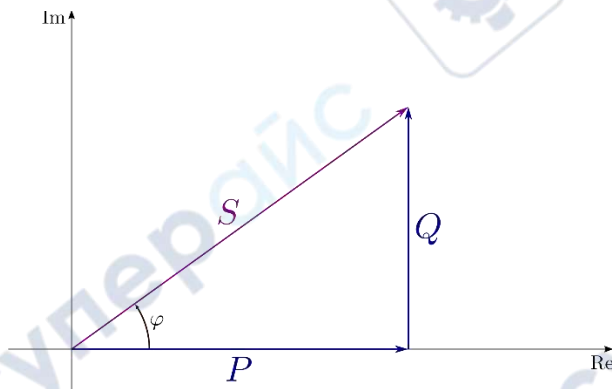

$$P: \text{Active Power} = \frac{1}{N} * \sum_{i=0}^{N-1} V_i * I_i$$

$$S: \text{Apparent Power} = V_{\text{rms}} * I_{\text{rms}}$$

$$Q: \text{Reactive Power} = \sqrt{\text{Apparent Power}^2 - \text{Active Power}^2}$$

φ : Power Phase Angle: Phase difference between voltage and current

$\cos \varphi$: Power Factor, which is the ratio of active power and apparent

power.

Voltage Crest -- Voltage parameters of the power input including voltage crest, voltage effective value, and voltage crest factor.

$$V_{rms} = \frac{1}{N} * \sqrt{\sum_{i=0}^{N-1} Vi^2}$$

$$V_Crest = V_{peak} / V_{rms}$$

Current Crest -- Current parameters of the power input including current crest, current effective value, and current crest factor.

$$I_{rms} = \frac{1}{N} * \sqrt{\sum_{i=0}^{N-1} Ii^2}$$

$$I_Crest = I_{peak} / I_{rms}$$

Signal Settings

Touch **Signal** to recall signal settings dialog box:

- Set the input voltage source
- Set the input current source
- Set the periods displayed
- View the connection guide
- Return to the previous menu

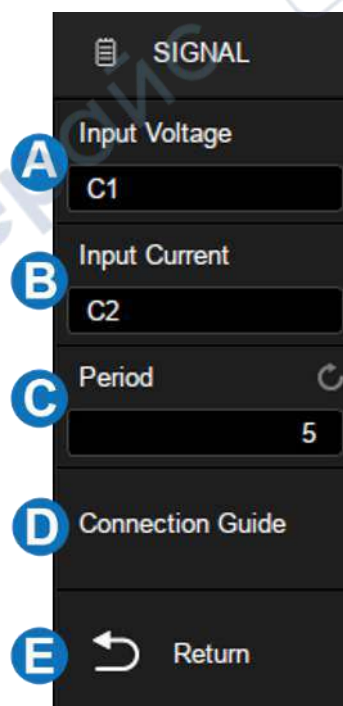

Connection Guide

Touch *Signal* > *Connection Guide* to recall the connection guide of power quality, as shown in the figure below. Please follow the instructions in this figure for correct connections. Touch the icon on the top right of the guide to close.

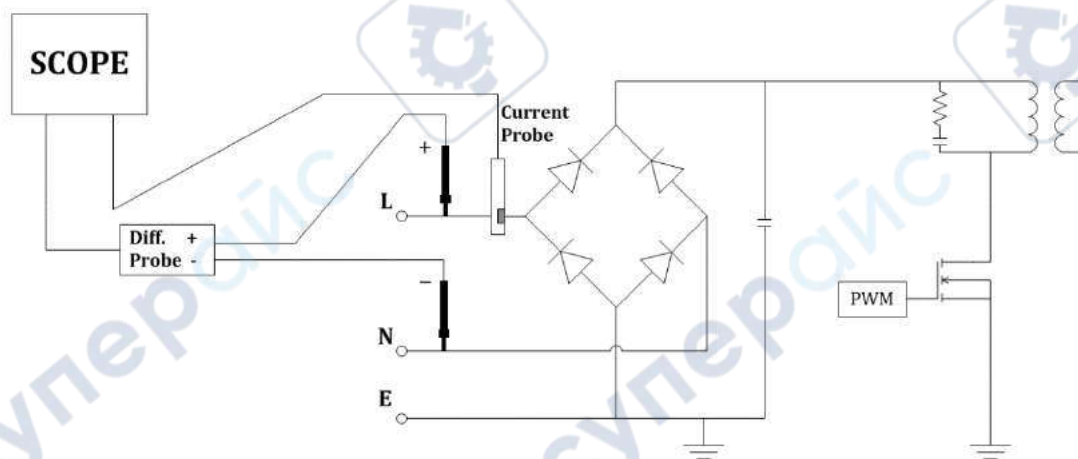

25.3 Current Harmonics

Current harmonics is used to analyze the input current harmonics. An FFT of the selected channel is performed to get the harmonic components. The signal settings and connection guide are the same as the power quality test.

Configuration

Touch *Config* to recall configuration dialog box:

- A. Set the frequency of the line
(Auto, 50 Hz, 60 Hz or 400 Hz)
- B. Set the standard type (IEC61000-3-2 A, IEC61000-3-2 B, IEC61000-3-2 C or IEC61000-3-2 D)
- C. Set the display type (Off, Bar Chart or Table)
- D. Return to previous menu

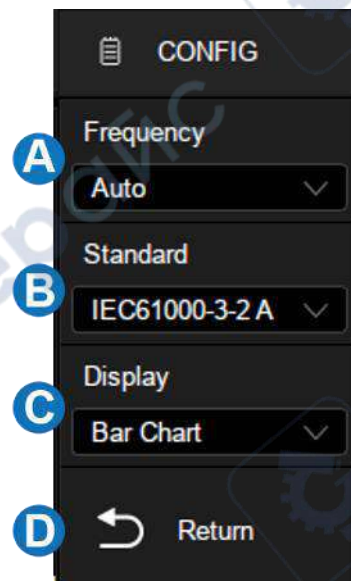

Standard

IEC 61000-3-2 is an international standard that limits mains voltage distortion by prescribing the maximum value for harmonic currents from the second harmonic up to and including the 40th harmonic current. There are 4 different classes in the EN 61000-3-2 that have different limit values:

- Class A: Balanced 3-phase equipment, household appliances excluding equipment identified as class D, tools, excluding portable tools, dimmers for incandescent lamps, audio equipment, and all other equipment, except that stated in one of the following classes.
- Class B: Portable tools, arc welding equipment which is not professional equipment
- Class C: Lighting equipment.
- Class D: PC, PC monitors, radio, or TV receivers. Input power $P \leq 600 \text{ W}$.

Parameter Description

For the first 40 harmonics, the following values are displayed:

Measured Value (RMS) -- The measured value displayed in the unit specified by the harmonic unit parameter

Limit Value (RMS) -- Limits specified by the selected standard

Margin (%) --The margin specified by selected standard parameters. The margin value is (standard value - measured value) / standard value * 100%

Pass/Fail State -- Determine whether the measured value is passed or failed according to the selected standard. The rows in the table or the bars in the bar chart are rendered in different colors based on the pass / fail state. When the value is greater than 85% of the limit but less than 100% of the limit, it is defined as a critical state.

Total Harmonic Distortion (THD) $= 100\% * \frac{\sqrt{X_2^2 + X_3^2 + \dots + X_n^2}}{X_1}$, where X_n is the nth harmonic, and X_1 is the basic component.

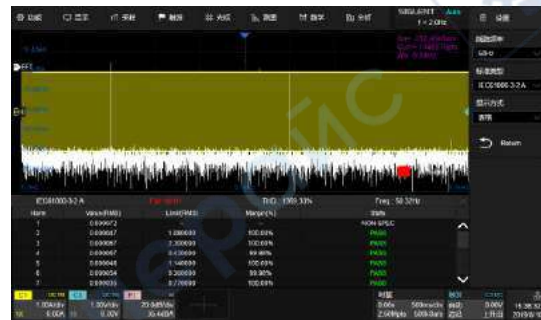

25.4 Inrush Current

A large current far greater than the stable current may flow through at the moment of switching on a power supply. The large current is called inrush current. The current waveform when switching on is shown

in the figure below:

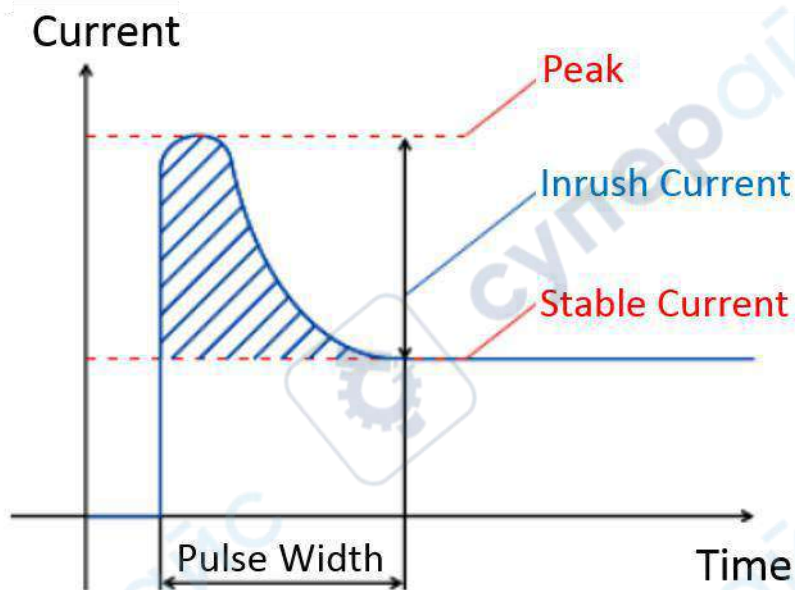

Signal Settings

Touch *Signal* to recall signal settings dialog box:

- Set the input voltage source
- Set the input current source
- Set the expected current value, the range is 100 mA ~ 500 A. The oscilloscope will set the trigger level to expected current/20 and the vertical scale of the current channel to expected current/3.
- Set the maximum effective input voltage (Vrms), the range is 1 V ~ 1 kV. The oscilloscope will set the vertical scale of the voltage

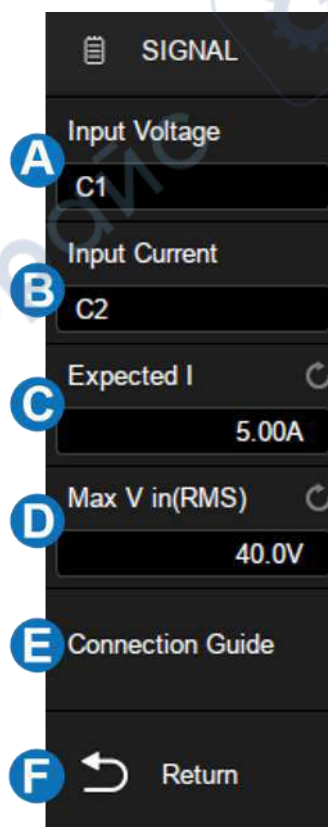

channel to maximum input
voltage/6

- E. View the connection guide
- F. Return to previous menu

25.5 Switching Loss

Switch loss analysis can be used to calculate the power dissipated in the switching period.

Deskew Calibration

A relatively small skew can cause a large measurement error of switching loss, especially during the on phase when the voltage is close to zero and the non-on phase when the current is close to zero. This is a typical oscilloscope dynamic range limitation when trying to measure weak voltage and (or) current in the presence of relatively large switching voltage and (or) current.

To correct the skew between the oscilloscope channels or probes, the deskew procedure should be performed once initially, and re-run when any part of the hardware setup changes (for example, a different probe, different oscilloscope channel, etc.) or when the ambient temperature changes. The deskew procedures by using the DF2001A deskew fixture is as followed.



- A. Demagnetize and zero-adjust the current probe
- B. Set up connections to the DF2001A deskew fixture

	Small Loop	Large Loop
Available current probes	CP4020 (100 kHz, 20 Arms) CP4050 (1 MHz, 50 Arms) CP4070 (150 kHz, 70 Arms) CP4070A (300 kHz, 70 Arms) CP5030 (50 MHz, 30 Arms) CP5030 (100 MHz, 30 Arms)	CP5150 (12 MHz, 150 Arms) CP5500 (5 MHz, 500 Arms)
High-voltage differential probe sense points	J7: signal terminal J6: earth terminal	J3: signal terminal J4: earth terminal

- a. Connect D+ and D- of the high-voltage differential probe to J7 and J6
- b. Connect the current probe to the loop with the direction

- of the arrow indicating the direction of the current flow
- c. Make sure the switch S1 on the deskew fixture is set to the appropriate side of the fixture (either “small loop” or “large loop”)
 - d. Connect the deskew fixture to a USB port on your oscilloscope or a PC using a USB cable. The USB port supplies power to the deskew fixture

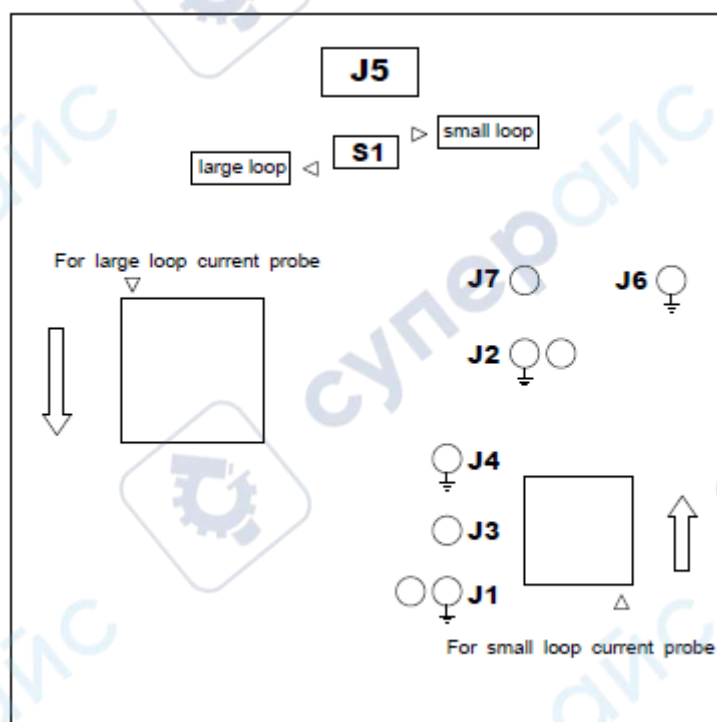

- C. Connect the voltage and current probes to the oscilloscope input channel
- D. Touch **Signal** to enter the signal setting menu. Select the corresponding input channel, and then touch **Auto Deskew** to perform the calibration. When the process completes, a message will pop up indicating whether the deskew operation was successful or not.



Before deskew calibration

After deskew calibration

Configuration

Touch *Config* to recall configuration dialog box:

- A. Set the voltage reference, i.e. the switch level at the edge of the input switch. This value is a percentage of the maximum switching voltage. Adjusting the value to ignore background noise. This value is used to determine the threshold hysteresis of the switch edge

- B. Set the current reference, i.e. the switch level at the beginning of the input switch edge. This value is the percentage of the maximum switching current. This value can be adjusted to ignore background noise or invalid offset that is difficult to

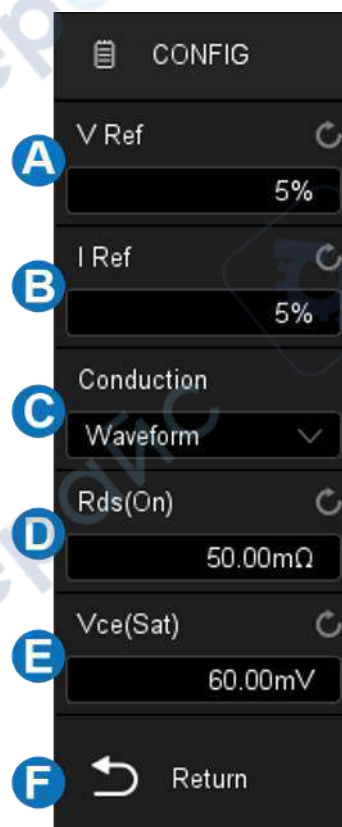

eliminate in the current probe.

This value is used to determine the threshold hysteresis of the switch edge

- C. Set the conduction type
(Waveform, Rds(on) or Vce(sat))
- D. Set Rds(on) resistance
- E. Set Vce voltage
- F. Return to previous menu

Conduction Type

Waveform -- The power waveform uses the original data, and the calculation formula is $P = V * I$, $E = P * T$.

Rds (on) -- In the on the area (where the voltage level is lower than the voltage reference (adjustable)), the power calculation formula is $P = I^2 * Rds (on)$. In the off area (where the current level is lower than the current reference (adjustable)), the power calculation formula is $P = 0$ watt.

Vce (sat) -- In the on area (where the voltage level is lower than the voltage reference (adjustable)), the power calculation formula is $P = Vce (sat) * I$. In the off area (where the current level is lower than the current reference (adjustable)), the power calculation formula is $P = 0$ watt.

Connection Guide

Touch *Signal* > *Connection Guide* to recall the connection guide of

switching loss, as shown in the figure below. Please follow the instructions in this figure for connection. Touch the icon on the top right of the guide to close.

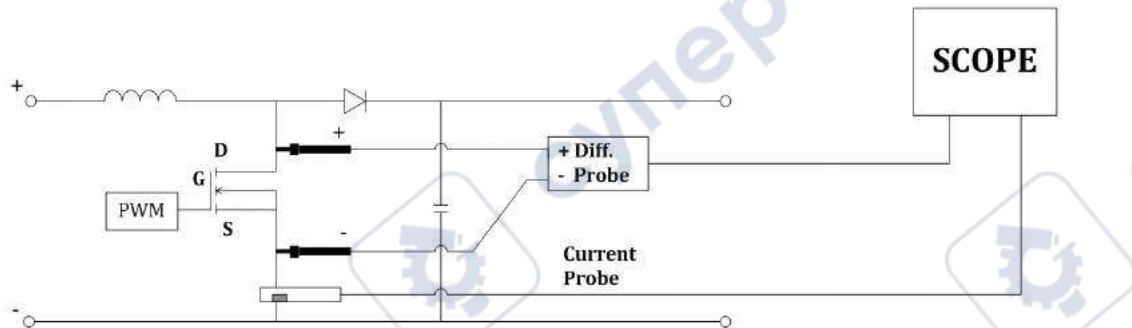

25.6 Slew Rate

The slew rate measures the change rate of voltage or current during switching.

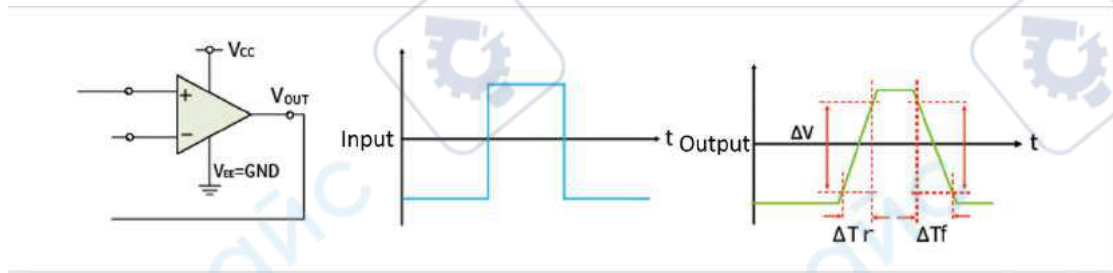

Connection Guide

Touch *Signal* > *Connection Guide* to recall the connection guide of slew rate, as shown in the figure below. Please follow the instructions in this figure for connection. Touch the icon on the top right of the guide to close.

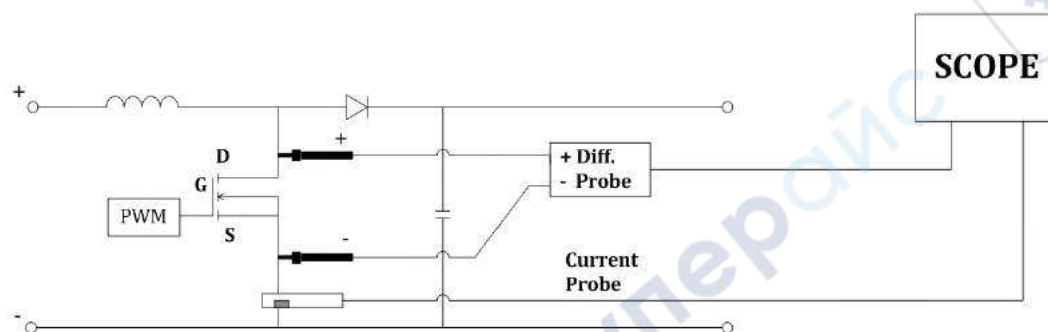

25.7 Modulation

Modulation analysis measures the control pulse signal of the switching device (MOSFET) and observes the pulse width, duty, period, frequency and other trends of the control pulse signal in response to different events.

Connection Guide

Touch **Signal** > **Connection Guide** to recall the connection guide of modulation, as shown in the figure below. Please follow the instructions in this figure for connection. Touch the icon on the top right of the guide to close.

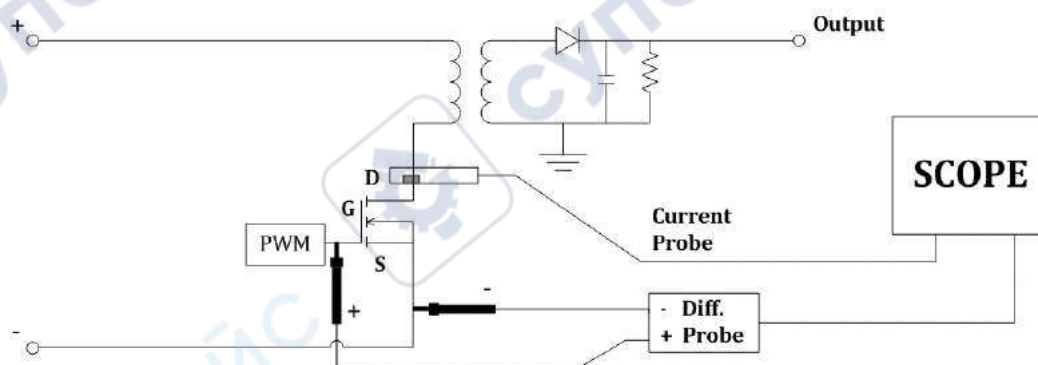

25.8 Output Ripple

Power supply ripple is an important parameter to evaluate DC power supplies, which represents the quality of output DC voltage. Ripple analysis can measure the current value, average value, minimum value, maximum value, standard deviation and count of the power supply output ripple.

Connection Guide

Touch *Signal* > *Connection Guide* to recall the connection guide of output ripple, as shown in the figure below. Please follow the instructions in this figure for connection. Touch the icon on the top right of the guide to close.

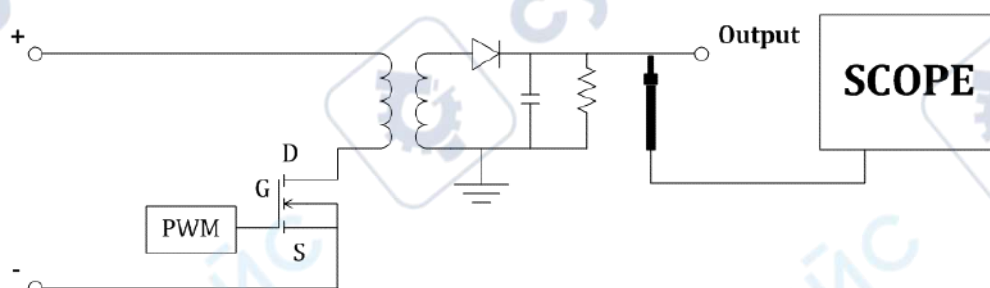

25.9 Turn On/Turn Off

Turn on analysis determines the time taken for the power supply to reach 90% of its steady-state output. Turn off analysis determines the time taken for the power supply to fall to 10% of its maximum output voltage.

Signal Settings

Touch *Signal* to recall signal settings dialog box:

- A. Set the input voltage source
- B. Set the output voltage source
- C. Set the input type (AC or DC)
- D. Set the duration, the range is 5 ns ~ 20 s. The oscilloscope will set the timebase according to the value (duration / 10)
- E. Set the maximum effective input voltage V_{rms} , the range is 1 V ~ 1 kV. The oscilloscope will set the vertical scale of the voltage channel to maximum input voltage / 7 and the trigger level to maximum input voltage / 10.
- F. Set the stable output voltage value, the range is -30 V ~ 30 V. The oscilloscope will set the vertical scale of the output voltage channel to stable output voltage / 6
- G. View the connection guide
- H. Return to previous menu

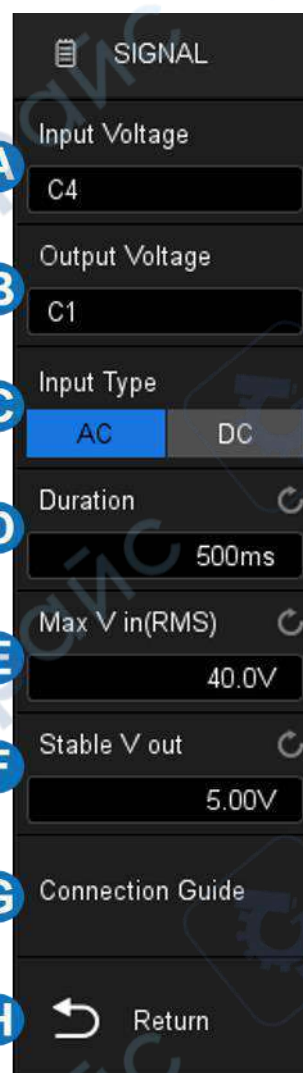

Testing Conditions

Turn On — Determines the time taken for the power to reach a certain

percentage of its steady-state output. The turning on time is between T2 and T1, where:

T1 = When the input voltage first rises to a certain percentage (usually 10%) of its maximum amplitude

T2 = When the output DC voltage rises to a certain percentage (usually 90%) of its maximum amplitude

Turn Off -- Defines the time that has elapsed after a power supply has been turned off and has fallen to a certain percentage of its maximum output voltage. The turning off time is between T2 and T1, where:

T1 = When the input voltage finally falls to a certain percentage (usually 10%) of its maximum amplitude

T2 = When the output DC voltage finally falls to a certain percentage (usually 10%) of its maximum amplitude

Connection Guide

Touch **Signal** > **Connection Guide** to recall the connection guide of the turn on/turn off setup, as shown in the figure below. Please follow the instructions in this figure for connection. Touch the icon on the top right of the guide to close.

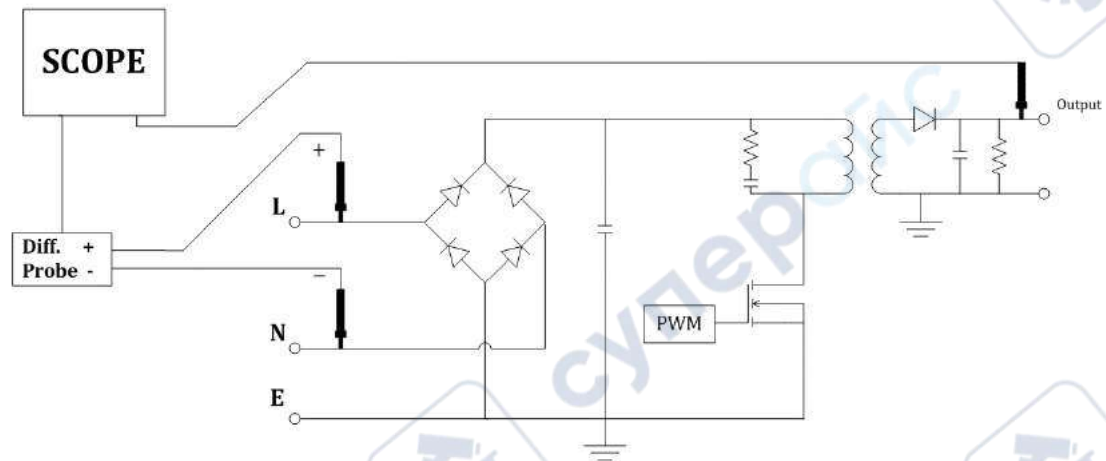

25.10 Transient Response

Transient response analysis can determine the response speed of the output voltage of the power supply to the change of the output load.

This time starts from the first time that the output voltage exits the stable band and ends at the last time that the output voltage enters the stable band.

Signal Settings

Touch *Signal* to recall signal settings dialog box:

- A. Set the output voltage source
- B. Set the output current source
- C. Set the duration. The oscilloscope will set the appropriate time base according to the duration
- D. Set the stable output voltage, i.e. the expected output DC voltage of the power supply in stable state
- E. Set the overshoot percentage of output voltage, which can be used to determine the stable band value of transient response and adjust the vertical scale of the oscilloscope
- F. View the connection guide
- G. Return to previous menu



Configuration

Touch *Config* to recall configuration dialog box:

- A. Set the input low current value.

This is the expected low current value before or after the load change

- B. Set the input high current value.

This is the expected high current value before or after the load change

- C. Return to previous menu

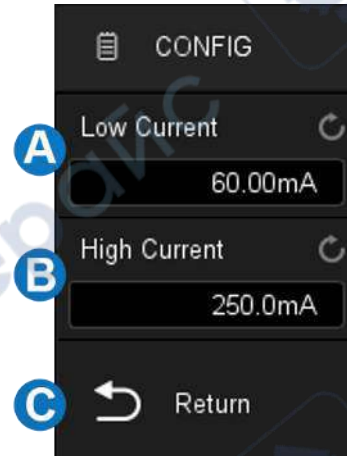

Note: low current value and high current value are used to calculate the trigger level and adjust the oscilloscope vertical scale. After the load changes, the current value changes from low to high (or from high to low), and the oscilloscope triggers and performs to measure the transient response stability time.

Connection Guide

Touch **Signal** > **Connection Guide** to recall the connection guide of transient response, as shown in the figure below. Please follow the instructions in this figure for connection. Touch the icon on the top right of the guide to close.

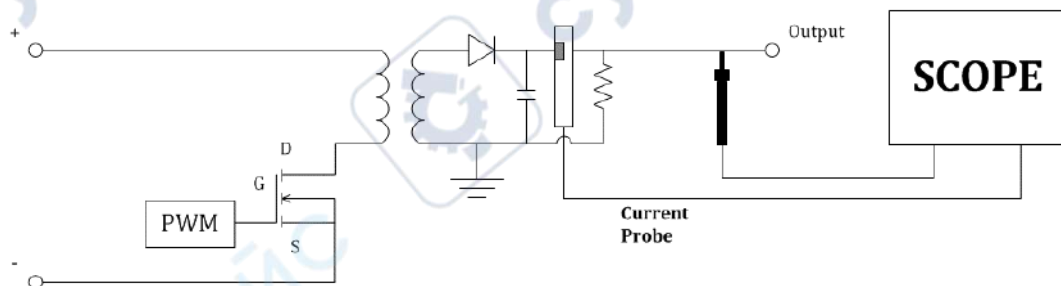

25.11 PSRR

The power supply rejection ratio (PSRR) test is used to determine how the regulator suppresses ripple noise in different frequency ranges. The oscilloscope controls the arbitrary waveform/function generator to output a sweep signal, which is used to introduce ripple into the DC voltage transmitted to the voltage regulator. Measure the AC RMS ratio of input to output, and plot the relationship between the ratio and frequency. The background noise of the oscilloscope is higher than that of the network analyzer, and the sensitivity is lower than that of the network analyzer, so the PSRR measured by the oscilloscope is difficult to exceed -60 dB. The PSRR test is generally acceptable for sampling the overall PSRR behavior of the power supply under test.

The configuration of PSRR is the same as that of the bode plot, see the chapter "Bode Plot" for details.

Connection Guide

Touch *Signal* > *Connection Guide* to recall the connection guide of PSRR, as shown in the figure below. Please follow the instructions in this figure for connection. Touch the icon on the top right of the guide to close.

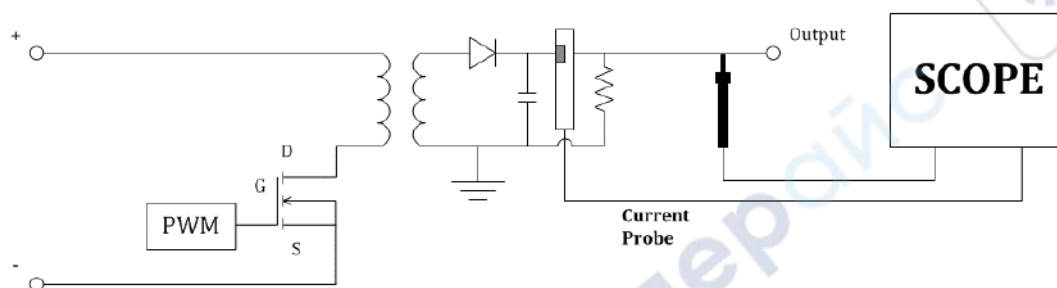

25.12 Power Efficiency

Power efficiency analysis can test the overall efficiency of the power supply by measuring the output power and input power. This analysis is only supported on 4-channel models because all of the input voltage, input current, output voltage, and output current are necessary for the measurement.

Connection Guide

Touch *Signal* > *Connection Guide* to recall the connection guide of power efficiency, as shown in the figure below. Please follow the instructions in this figure for connection. Touch the icon on the top right of the guide to close.

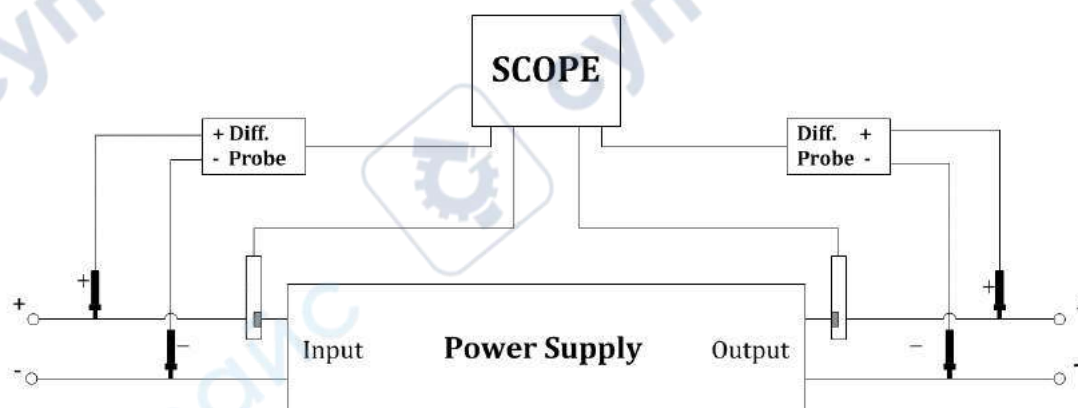

26 Bode Plot

26.1 Overview

The SDS2000X Plus supports an automatic bode plot function. This function provides a frequency response curve of the device-under-test as well as the interface for output sweep parameter control and data display settings. At this time, either the built-in waveform generator or one of a SIGLENT SDG series arbitrary function generators are supported. During the sweep, the oscilloscope configures the generator output frequency and amplitude and then compares the input signal to the output of the DUT. Gain (G) and phase (P) are measured at each frequency and plotted on the frequency response bode plot. When the loop response analysis is complete, you can move the markers on the chart to see the gain and phase values measured at each frequency point. You can also adjust the scale and offset settings for the amplitude and phase plots.

Touch *Analysis* > *Bode Plot* to recall the bode plot dialog box:

- A. Turn on/off the bode plot
- B. Configure the bode plot (DUT, AWG connection, sweep parameters)
- C. Turn on/off the operation
- D. Set display parameters. You can set the coordinate axis of bode plot, trace visibility display, and cursors of bode plot
- E. Data list. Open the data list of bode plot to view the curve data, or save the data results to a U-disk or recall it from a U-disk
- F. Set the measurement parameters. Parameter measurement of scanning curve includes upper cut-off frequency (UF), lower cut-off frequency (LF), bandwidth (BW), gain margin (GM) and phase margin (PM)



26.2 Configuration

26.2.1 Connection

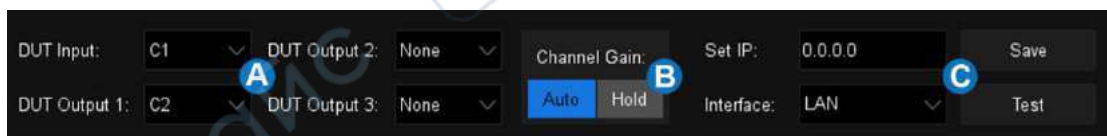

- A. DUT input and output channels

- B. Channel gain. When it is set to Auto, the oscilloscope will automatically adapt the vertical scale according to the signal amplitude. When it is set to Hold, it will always keep the currently selected vertical scale. If signals overload the selected range in Hold mode, the data may not accurately represent the physical test.
- C. Arbitrary waveform generator connection settings. Touch *Interface* to select the connection type. When selecting LAN, it needs to *Set IP* and *Save* it. Touch *Test* to confirm whether the arbitrary waveform generator is connected correctly.

26. 2. 2 Sweep

Touch *Sweep Type* to select the sweep type. There are two types: Simple and variable level.



- A. Set the sweep type to simple

- B. Set the sweep frequency. The frequency mode can be linear or decade. When it is set to linear, the corresponding center frequency and span frequency need to be set. When it is set to decade, the corresponding start frequency and stop frequency need to be set
- C. Set the number of sweep points. The larger the number of points, the higher the sweep resolution
- D. Set the amplitude of sweep signal
- E. Set the offset of the sweep signal
- F. Set the signal amplitude unit. When it is set to dB, reference level and load need to be set
- G. Set the load

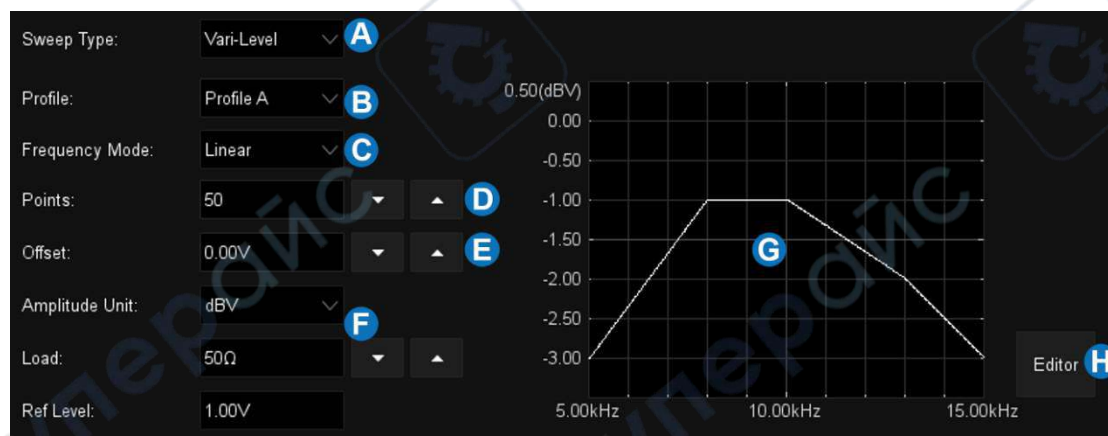

- A. Set the sweep type to Vari-Level
- B. Select a profile. Up to 4 profiles can be edited
- C. Set the frequency mode
- D. Set the number of sweep points
- E. Set the offset of the sweep signal

- F. Set the signal amplitude unit. When it is set to dB, reference level and load need to be set
- G. Variable level signal display area
- H. Touch *Edit* to turn on the profile editor

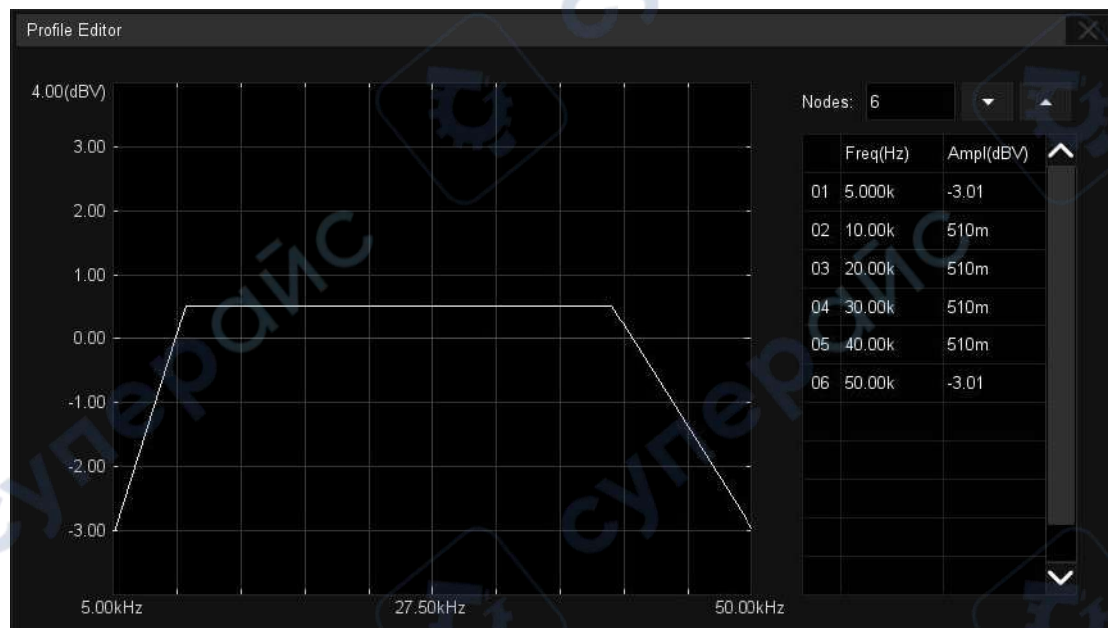

Touch *Nodes* to set the signal node number through the universal knob, or touch ▲ to increase the nodes and ▼ to decrease.

Touch the cell in the table area to set the frequency and amplitude of the corresponding node. Touch to activate the cell, adjust the value through the universal knob, or touch the cell again to call up the virtual keypad.

26.3 Display

Bode plot display settings include amplitude, phase, cursors and trace

visibility.

Amplitude

Set the amplitude coordinate axis of the bode plot. Touch *Display* > *Amplitude* to recall the amplitude setting dialog box:

- A. Set the scale of the amplitude coordinate axis
- B. Set the reference level, the max value of the amplitude coordinate axis
- C. Set the amplitude mode. Set to Vout to display the amplitude value of the output signal; set to Vout/Vin to display the amplitude ratio of the output signal to the input signal
- D. When the mode is Vout, it needs to set the unit (Vpp, Vrms, dBV, dBu, dBm or Arbitrary dB); when the mode is Vout/Vin, it needs to set the amplitude axis type (Linear or Logarithmic).
- E. Auto Set. According to the output signal amplitude curve, the oscilloscope automatically sets the scale and reference level
- F. Return to the previous menu



Phase

Set the phase coordinate axis of the bode plot. Touch *Display>Phase* to recall the phase setting dialog box:

- A. Set the scale of the phase coordinate axis
- B. Set the reference level, the max value of the phase coordinate axis
- C. Set the phase unit (Degree or Rad)
- D. Auto-Set. According to the output signal phase curve, the oscilloscope automatically sets the scale and reference level
- E. Return to previous menu

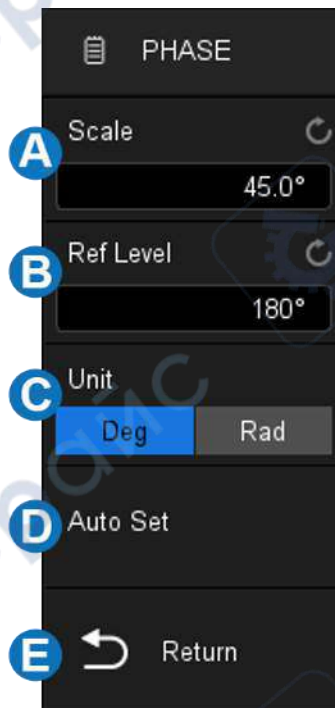

Cursors

SDS2000X Plus can use the cursor to measure the bode plot curve. The cursor of the bode plot is similar to the ordinary cursor, see the chapter "Cursors" for details. Touch *Display>Cursors* to recall the cursor setting dialog box.

- A. Turn on/off the cursors of bode plot
- B. Set the cursors type (X or Y)
- C. Specify the cursor and set the position (by gestures, universal knob, or virtual keypad)
- D. Set the source 1
- E. Set the source 2
- F. Return to previous menu

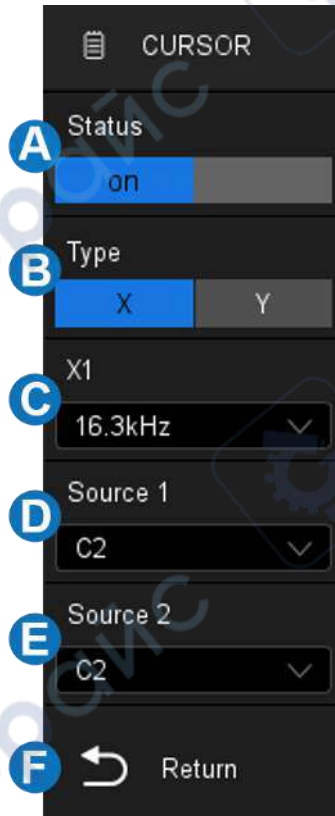

Trace Visibility

When multiple output signals are connected, the bode plot interface will display the amplitude and phase curves of all output signals at the same time. Users can turn on/off other scanning curves to observe the details of specific curves. Touch *Display* > *Trace Visibility* to recall the setting dialog box.

26.4 Data Analysis

With the data list, cursor measurement and automatic measurement functions, the bode plot curve can be analyzed in detail. The data list provides the information of each scanning point. The cursors can be used to flexibly measure the change of each position of the curve. The

automatic measurement function can be used to measure the five parameters of the bode plot curve: Upper cut-off frequency (UF), lower cut-off frequency (LF), bandwidth (BW), gain margin (GM), phase margin (PM).

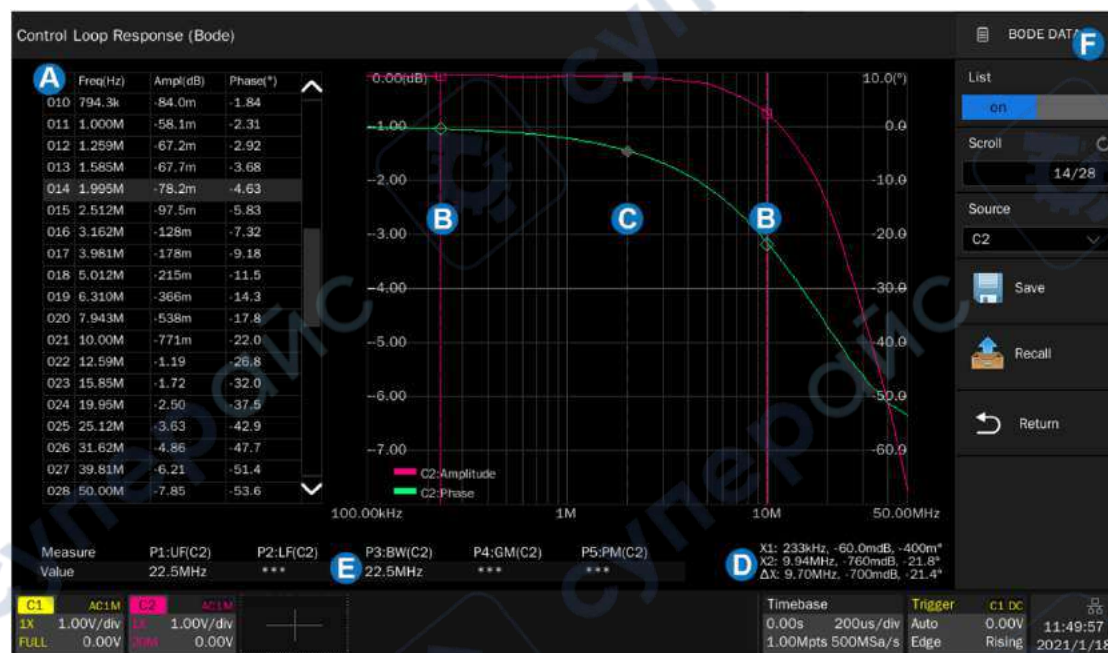

- Data list display area
- Cursors
- Datapoint location line
- Cursor information display area
- Measurement parameters display area
- Bode plot dialog box

Data List

Touch *Data* to recall the data setting dialog box:

- A. Turn on/off the data list
- B. Set the selected row in the list.
Adjust the universal knob to set, or directly touch the list display area to select a specific line.
- C. Set the data source
- D. Save/Recall the data. Saving and recalling bode plot data (*.csv) is similar to the operation of setup files, see the chapter "Save/Recall" for details
- E. Return to previous menu

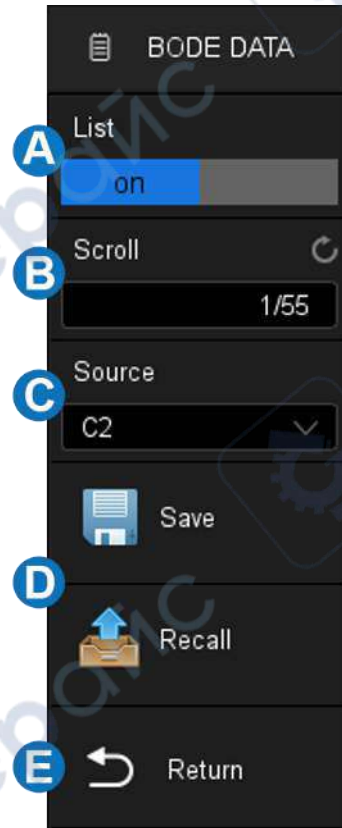

Measure

Touch *Measure* to recall the measure setting dialog box:

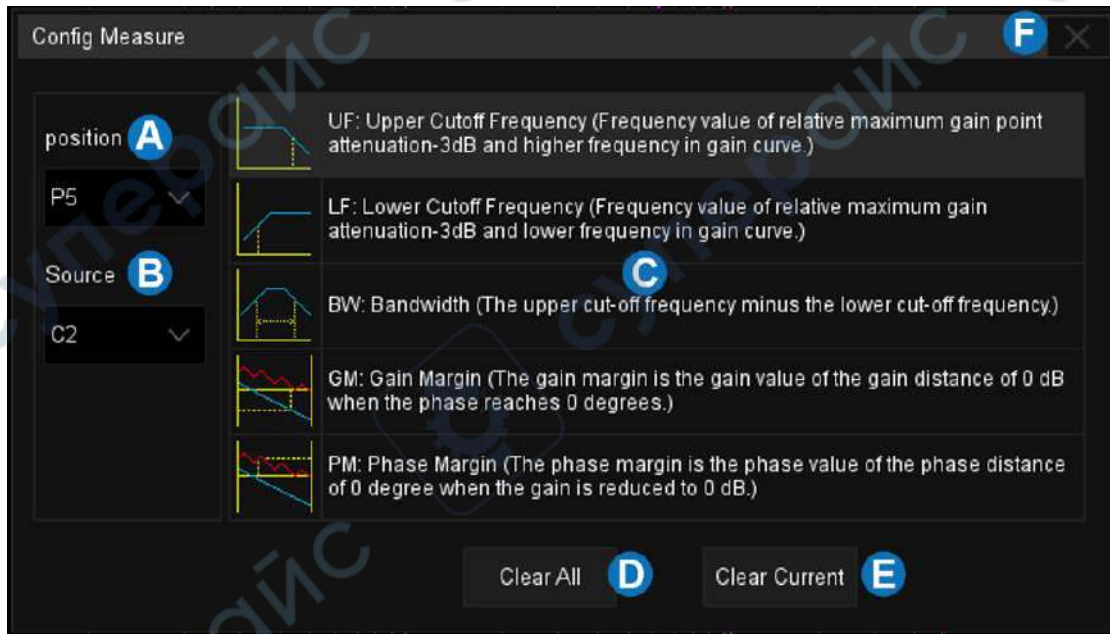

- A. Set the position of measurement items, and support 5

measurement items at most

- B. Set the measurement source
- C. Measurement parameter area. Touch each parameter area to activate the measurement parameter. In the figure above, "UF" is activated.
- D. Clear all measurements
- E. Clear the current measurement
- F. Close the measurement configuration window

For example, to add UF measurements for C2 and GM measurements for C3, follow the steps below:

Measure > *Position* > *Source* > *UF*

Measure > *Position* > *Source* > *GM*

27 Display

Display settings include display type of waveform, color, persistence, grid type, trace brightness, graticule brightness, etc.

Press the **Display/Persist** button, or touch the menu *Display* > *Menu* to recall the display dialog box.

- A. Switch the waveform display type to Vectors (line display) or Dots
- B. Turn on or off color grade
- C. Set persist
- D. Clear persist
- E. Clear display. The operation clears all waveforms displaying on the screen and clear persist
- F. The dialog box is automatically hidden after the set time. When set to “Off” it can only be hidden by manual
- G. Set the menu style to Embedded or Floating. When set to Embedded, the grid area will be compressed horizontally to display the complete waveform when the dialog box is displayed. When set to Floating, the dialog box will directly cover part of the grid area
- H. Select the grid type (Full Grid, Light Grid and No Grid)
- I. Set the trace intensity (0~100%), Backlight (0~100%); graticule brightness (0~100%) and LEDlight (0~100%)
- J. Set the color of traces

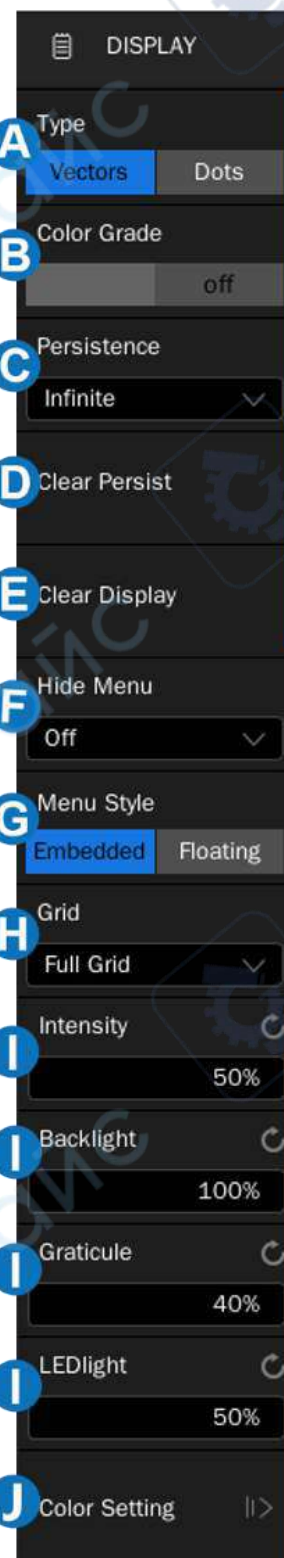

Display Type

There is no difference between the vector and dot display types when the number of samples of a frame is greater than 1000. When the sample number is below 1000, there are some differences.

- **Vectors:** The samples are connected by lines (i. e. interpolated) and displayed. The interpolation methods include linear interpolation and $\sin(x)/x$ interpolation. See the section of "Acquisition Setup" for details of interpolation.
- **Dots:** Displays the raw samples directly.

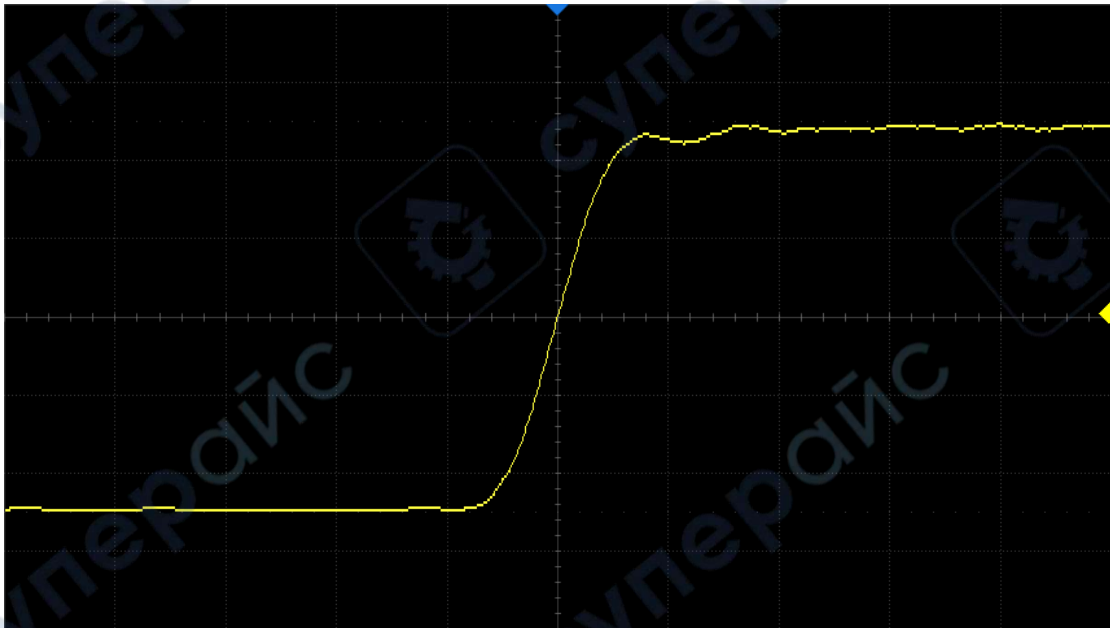

Vector Display

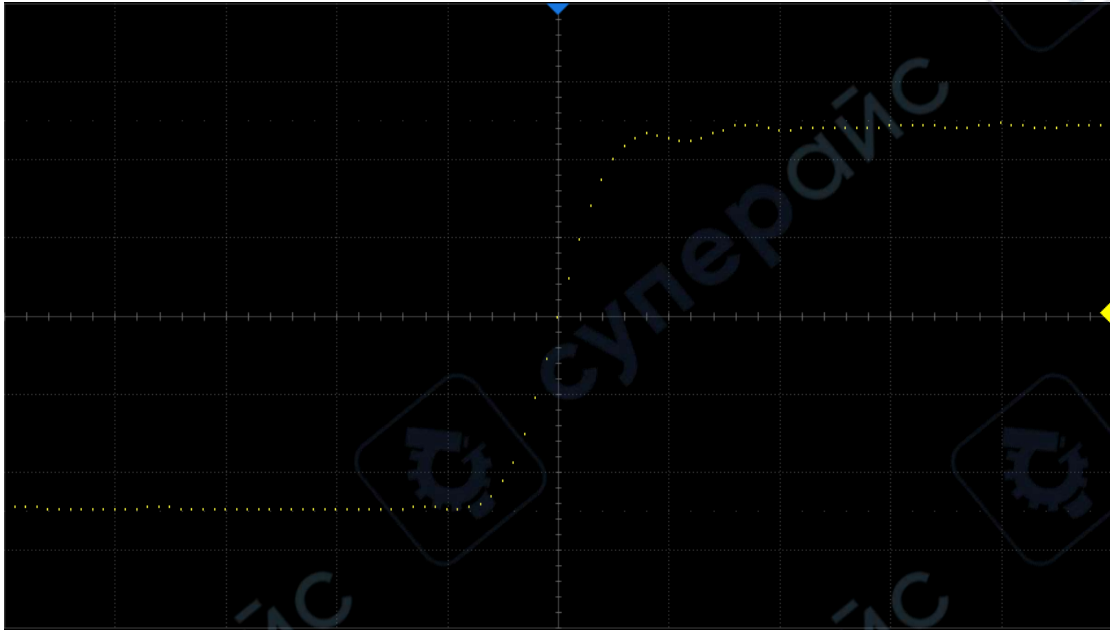

Dot Display

Note: In the Run state, due to the high waveform update rate of the oscilloscope, the waveform displayed is the superposition of multiple frames. Therefore, what is seen using the dots display is not the discrete sampling points, but the display effect similar to equivalent sampling. Stop the acquisition to view the original samples of each frame separately.



Dots display in Run state

Color Grade

Color grade uses color temperature to map the probability of the waveforms. The greater the probability that the waveform appears in a pixel, the warmer the color of the pixel. The smaller the probability, the colder the color temperature of that pixel.

The picture below shows the change of color from cold to warm.

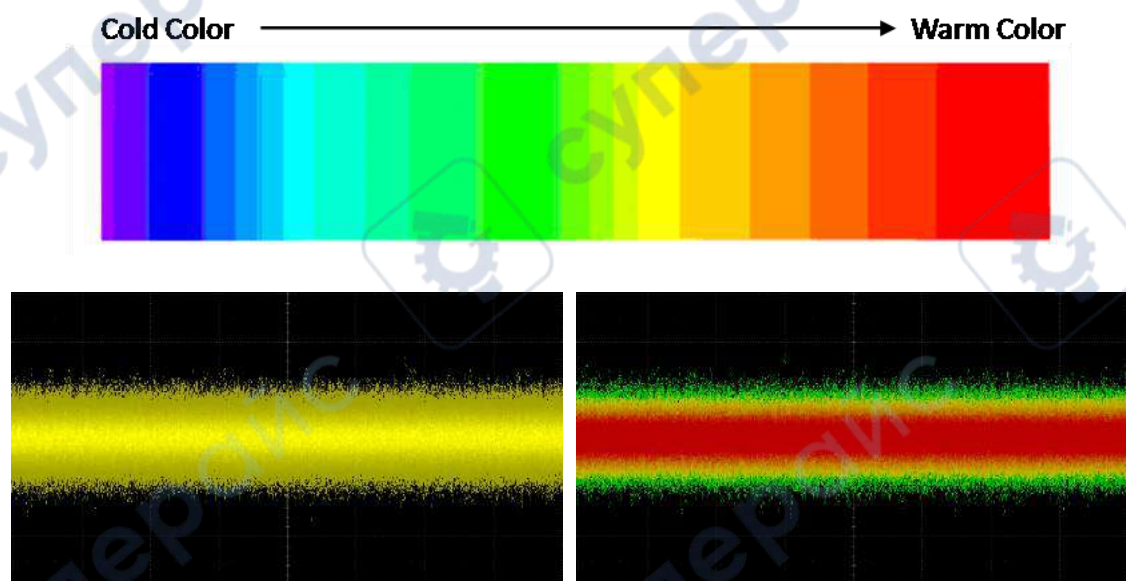

Color grade On

Color grade Off

Set Persist

With persistence, the oscilloscope updates the display with new acquisitions but does not erase the results of previous acquisitions in the specified period. All previous acquisitions are displayed with reduced intensity. New acquisitions are shown in their normal color

with normal intensity. In combination with SDS2000X Plus's high waveform update rate and persist function, in some cases anomalies in the waveform can be found in a short time without complex trigger settings to improve test efficiency. Below is an example to display glitches in a data sequence with an infinite persistence.

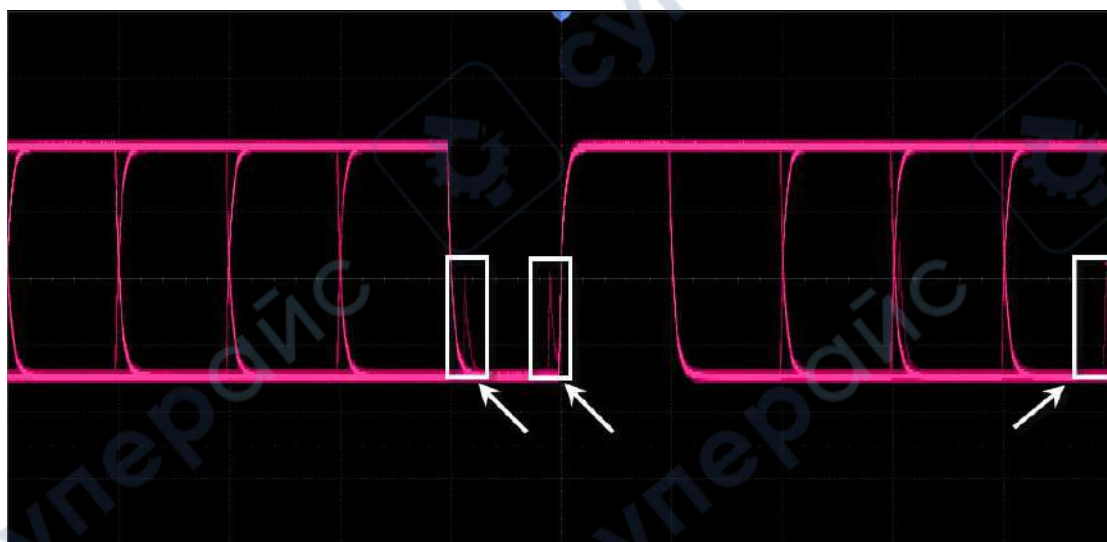

When the display dialog box and persist are off, double-pressing the **Display/Persist** button on the front panel can quickly turn on persistence.

Touch **Persist** in the display dialog box to set the persistence time.

- **Off:** Turn off persist.
- **Variable persist time (1s, 5s, 10s, 30s):** Choose different persist times. The oscilloscope updates with the newly acquired waveform display. Acquired waveforms will be cleared after the corresponding time has expired.
- **Infinite:** Select “Infinite”, previous acquisitions will never be erased until a **Clear Display** or **Clear Sweeps** operation is

performed.

Set Grid

- **Full Grid:** Display 8*10 grid
- **Light Grid:** Display 2*2 grid
- **No Grid:** Display without grid

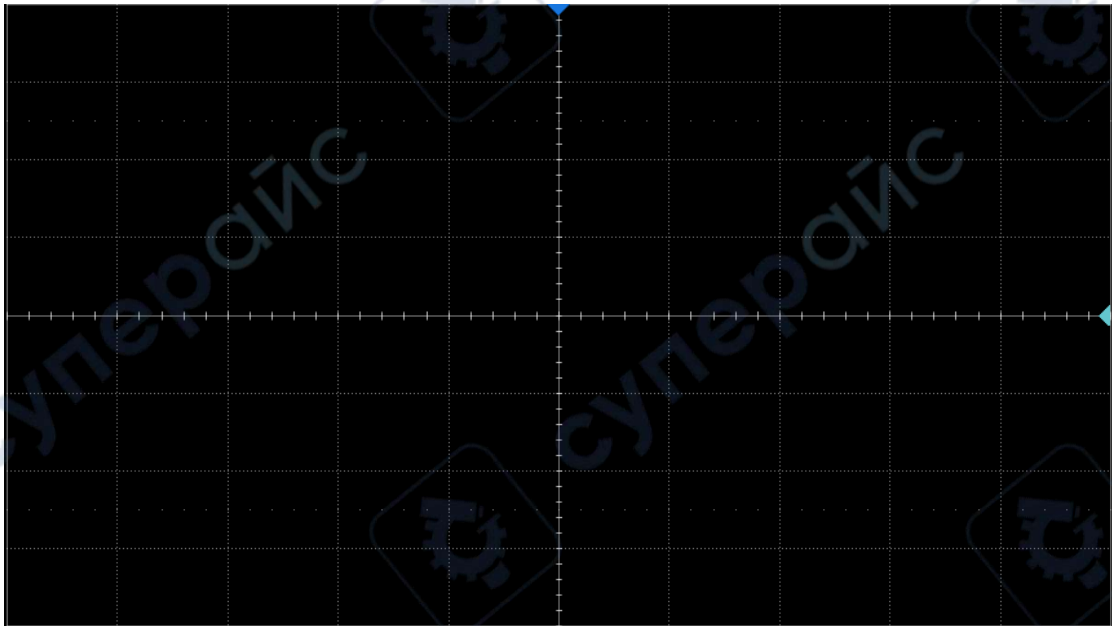

Full Grid

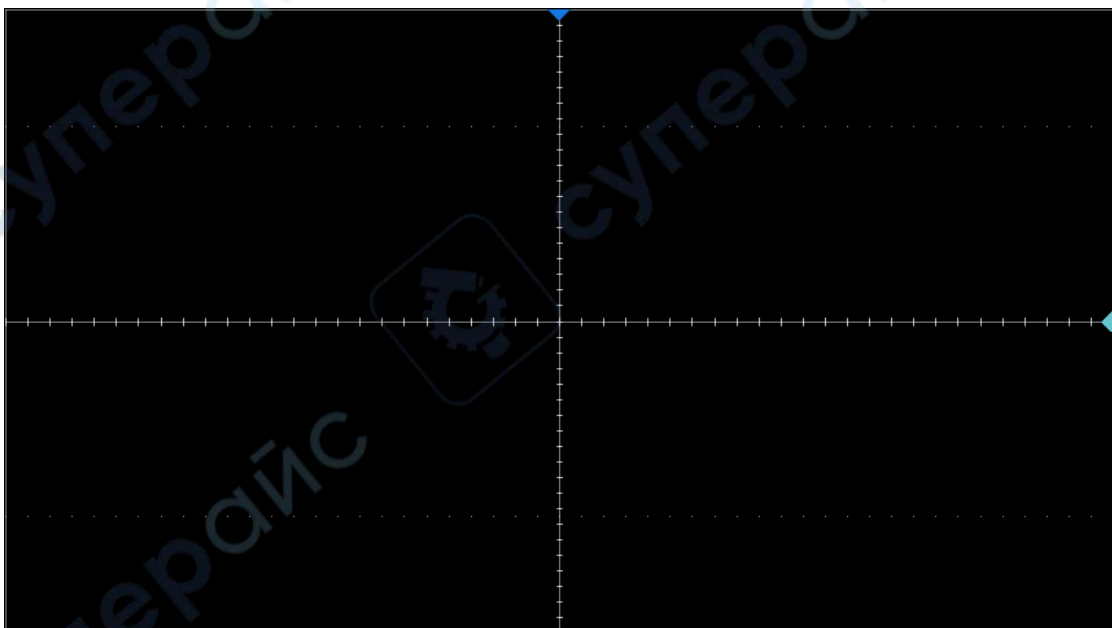

Light Grid



No Grid

Color Setting

Color setting supports user-defined trace colors. Touch the color rectangle box to set in the pop-up palette page. Touch *Default* area to restore the default color for all channels.

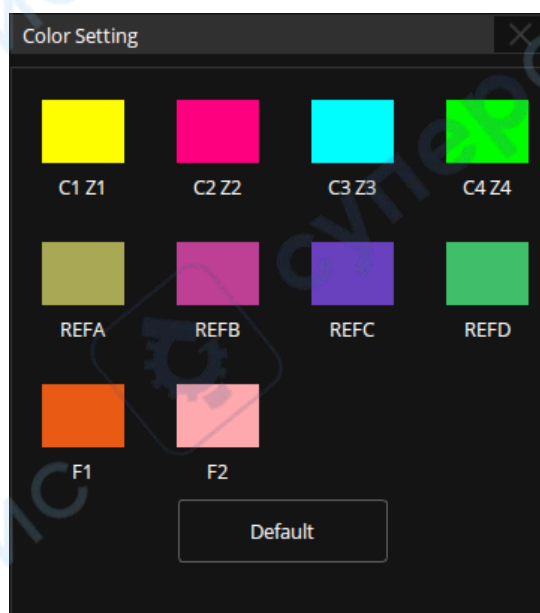

Select a color directly on the palette and preview its hue, saturation,

light, and RGB values or directly modify the color parameters to customize the color. After the change, touch *OK* to confirm.

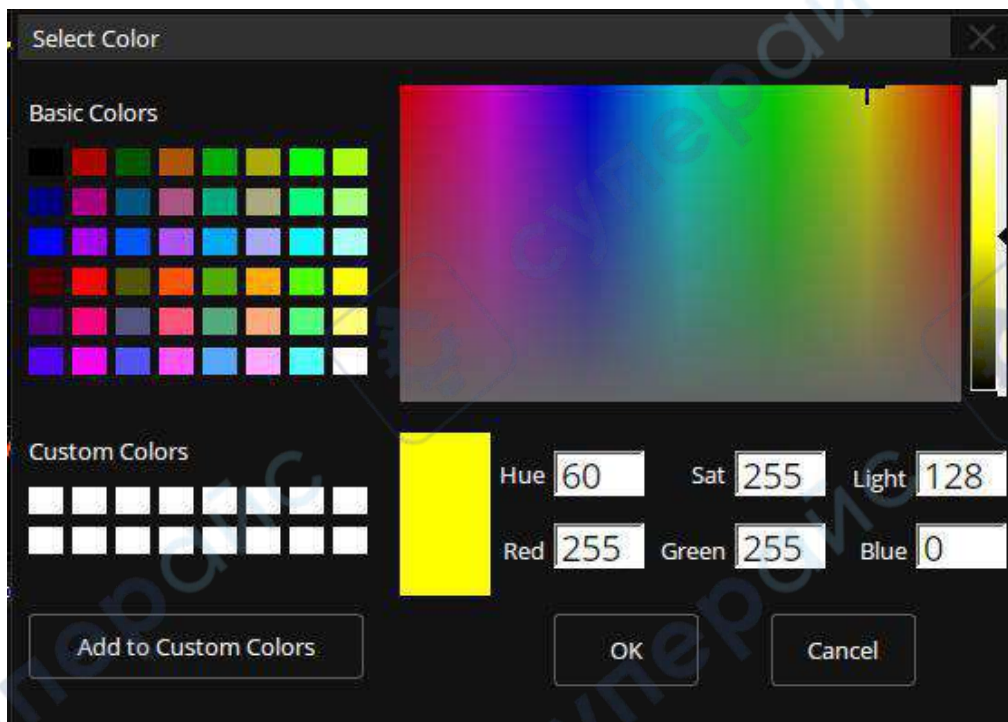

28 Arbitrary Waveform Generator

28.1 Overview

The SDS2000X Plus supports a built-in arbitrary waveform/function generation when activated using option SDS_2000XP_FG.

The AWG functions include:

- 6 basic waveforms: Sine, Square, Ramp, Pulse, Noise, and DC
- 45 built-in and 2 custom arbitrary waveforms
- Output frequency up to 50 MHz
- $-3\text{ V} \sim +3\text{ V}$ output amplitude range

Refer to the datasheet for the detailed specifications of the AWG.

Press the **WaveGen** button on the front panel, or touch the menu **Utility**>**AWG Menu** to recall the AWG dialog box.

- A. Turn on/off the output of AWG
- B. Select the waveform type (Sine, Square, Ramp, Pulse, Noise, DC and Arb)
- C. Set the frequency
- D. Set the amplitude
- E. Set the offset
- F. Other AWG settings: output load, overvoltage protection and so on.

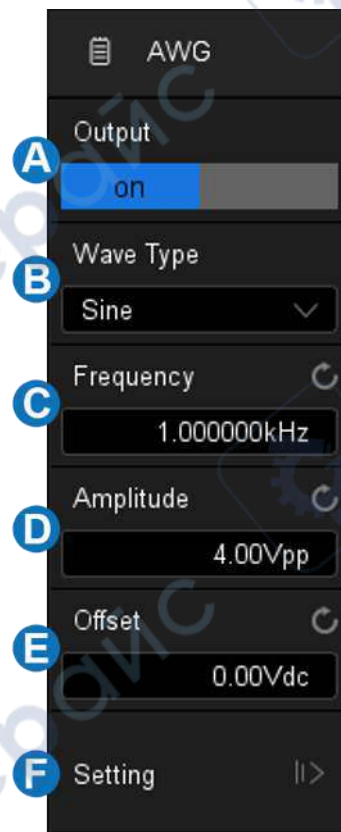

28.2 Output

For safety, pressing the **Wave Gen** button does not automatically turn on the output of AWG. To turn on the output, touch *Output* in the AWG dialog box after pressing **Wave Gen**. When the output is enabled, the **Wave Gen** button lights up.

28.3 Wave Type

The AWG function provides six standard waveforms and multiple arbitrary waveforms. The standard waveforms are Sine, Square, Ramp, Pulse, Noise, and DC.

The following table shows all waveform types and corresponding parameters.

Wave Type	Parameters
Sine	Frequency, Amplitude, Offset
Square	Frequency, Amplitude, Offset, Duty
Ramp	Frequency, Amplitude, Offset, Symmetry
Pulse	Frequency, Amplitude, Offset, Duty
DC	Offset
Noise	Stdev, Mean
Arb	Frequency, Amplitude, Offset, Arb Type

The Arbitrary waveforms consist of two types: built-in waveforms and stored waveforms. Touch *Arb Type* in the AWG dialog box, and select the arbitrary in the pop-up window:

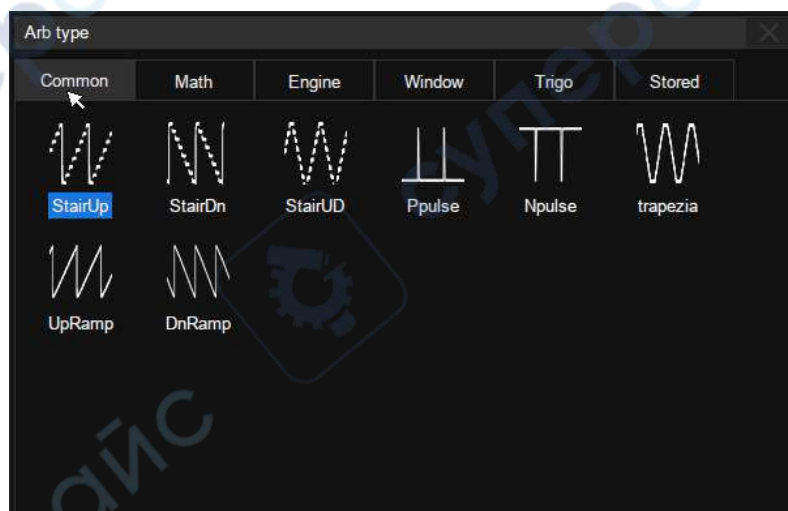

There are 6 tabs in the window. Under each tab, a catalog of waveforms are listed. Built-in waveforms are stored in Common, Math, Engine, Window, and Trigo. Stored waveforms are located in the Stored menu.

Users can edit arbitrary waveforms using SIGLENT EasyWave PC software, and send the stored waveforms to the instrument through the remote interface, or import the stored waveforms through a U disk.

28.4 Other Setting

Touch *Setting* in the AWG dialog box to recall "Other Setting" dialog box:

- A. Select the output load
- B. Turn on/off the OVP (Over Voltage Protection)
- C. Do zero adjust
- D. Set to default
- E. Return to previous menu



Output Load

The selected output load value must match the load impedance. Otherwise, the amplitude and offset of the output waveform of AWG will be incorrect.

OVP

When OVP is enabled, the output will be turned off automatically once the protection condition is met. The protection condition is when the absolute value on the output port is higher than $4\text{ V} \pm 0.5\text{ V}$). At the same time, a warning message is displayed.

Zero Adjust

The output zero error of the AWG can be calibrated by using auto mode or manual mode. The object of the Zero Adjust is: when AWG outputs 0V DC signal, the measured mean value of the corresponding channel is within $\pm 1\text{mV}$.

- **Auto Steps:** In this mode, the adjustment can only be performed with CH1 of the oscilloscope. Connect the output of AWG to CH1 of the oscilloscope, press *Auto*, and the AWG will start to automatically adjust. The scope will display “Zero adjust completed!” when the adjustment is done.
- **Manual Steps:** The AWG can be manually calibrated through any channel on the oscilloscope. Take CH2 as an example:
 1. Connect the output of AWG to CH2, open CH2, set it to DC coupling, turn on bandwidth limit, and set the probe attenuation to 1X.
 2. Set the vertical scale of CH2 to a small scale such as 1mV/div. Turn on measure and set the parameter to Mean of CH2.
 3. Press *Manual* and rotate the universal knob to adjust the compensation value, until the mean value of CH2 is within $\pm 1\text{mV}$, and then press *Save*.

29 Save/Recall

The SDS2000X Plus supports saving setups, reference waveforms, screenshots, and waveform data files to internal storage or external USB storage devices (e.g. U disk). Saved setups and reference waveforms can be recalled as needed.

29.1 Save Type

SDS2000X Plus supports save types: Setup, Reference, Image (*.bmp/*.jpg/*.png), Waveform Data (binary/csv/matlab) and Bin2CSV tool. It also supports saving the current setup as default setting.

Here are brief descriptions of save types:

Setup

This is the default file save type of the oscilloscope. Setups can be saved into internal or external memory with the *.xml file extension. Up to 10 setup files can be stored in the internal memory (No.1 ~ No.10).

Reference

The reference waveform data are saved to external memory with the *.ref file extension. The saved file contains the reference waveform data and its setup information such as the vertical scale, vertical position, and timebase.

BMP

Saves the screenshot to external memory in *.bmp format.

JPG

Saves the screenshot to external memory in *.jpg format.

PNG

Saves the screenshot to external memory in *.png format.

Binary Data

Saves the waveform data to external memory in binary (*.bin) format.

CSV Data

Saves the waveform data to the external memory in ".csv" format. After selecting this type, you can touch the *ParaSwitch* to determine to include the scope configuration parameter information (horizontal timebase, vertical scale, etc.) or not. Touch the *Save All Channel* to save all displayed waveforms on the screen or select the *Source* to save. The available sources include C1 ~ C4 and F1 ~ F2.

Matlab Data

Saves the waveform data to external memory in *.mat format which can be imported by Matlab directly. The available sources include C1 ~ C4 and F1 ~ F2.

To Default Key

The oscilloscope provides two options for the default setting. When the Default Type is set to “Factory”, the factory default setting will be recalled by pressing the **Default** button on the front panel; When the Default Type is set to “Current”, the last setting saved by the “To Default Key” operation will be recalled by pressing the **Default** button on the front panel.

Bin2CSV Tool

The mini tool is used to convert stored binary files to CSV format for viewing with a spreadsheet program. This is ideal when collecting large datasets. For a waveform frame with deep memory such as 200 Mpts, to save directly as a CSV file will take long time and will occupy a large amount of memory on a USB storage device. It's recommended to save the data as binary file and then convert it to CSV file on a computer.

The following table shows the relationship between the save types and save/recall operations.

Type	Save to Internal	Save to External	Recall
Setup	√	√	√
Reference	×	√	√
BMP	×	√	×
JPG	×	√	×

PNG	×	√	×
Binary Data	×	√	×
CSV Data	×	√	×
Matlab Data	×	√	×

*Save/Recall only supports saving Reference to external memory. However, the reference waveform itself can be saved to internal memory. See the chapter "Reference" for details.

29.2 Internal Save and Recall

"Setup" can be saved/recalled to/from the internal memory. In this section the save/recall operations of Setup are introduced.

Save oscilloscope setup to internal memory

Follow the steps below:

- A. Select *Mode* as "Save"
- B. Select *Type* as "Setup"
- C. Select *Save Path* as "Internal"
- D. Select *No.* of internal storage locations, 1~10 optional.
- E. Touch *Save* to perform the save operation

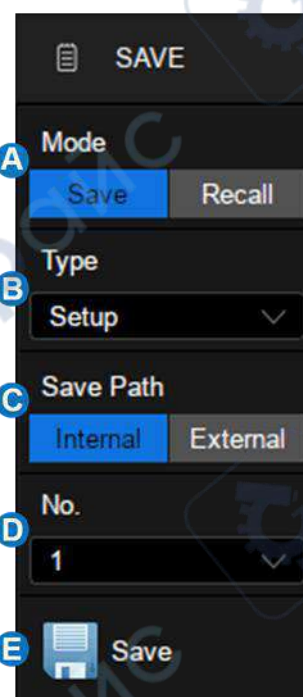

A progress bar is shown when the Save operation is in progress. When it is done, the oscilloscope prompts "Saved to internal file No.X", where X is the internal storage location index selected in the step **D**.

Recall oscilloscope setup from internal memory

Follow the steps below:

- A. Select *Mode* as "Recall"
- B. Select *Type* as "Setup"
- C. Select *Recall Path* as "Internal"
- D. Select *No.* of internal storage locations, 1~10 optional
- E. Touch *Recall* to perform the recall operation

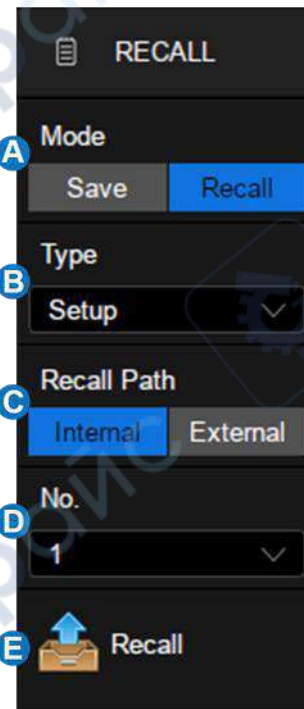

29.3 External Save and Recall

Before performing an external save or recall, make sure the USB storage device is connected correctly.

- A. Select *Save Path* as "External"
- B. Touch the *File Manager* and open the file manager. If the U disk is not properly connected, the system will prompt "USB flash drive not detected!"

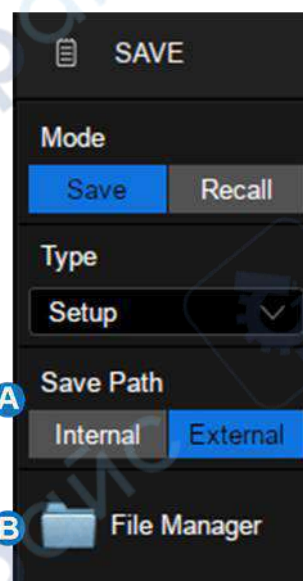

29.3.1 File manager

The SDS2000X Plus's file manager has similar style and operation with the Windows operating systems.

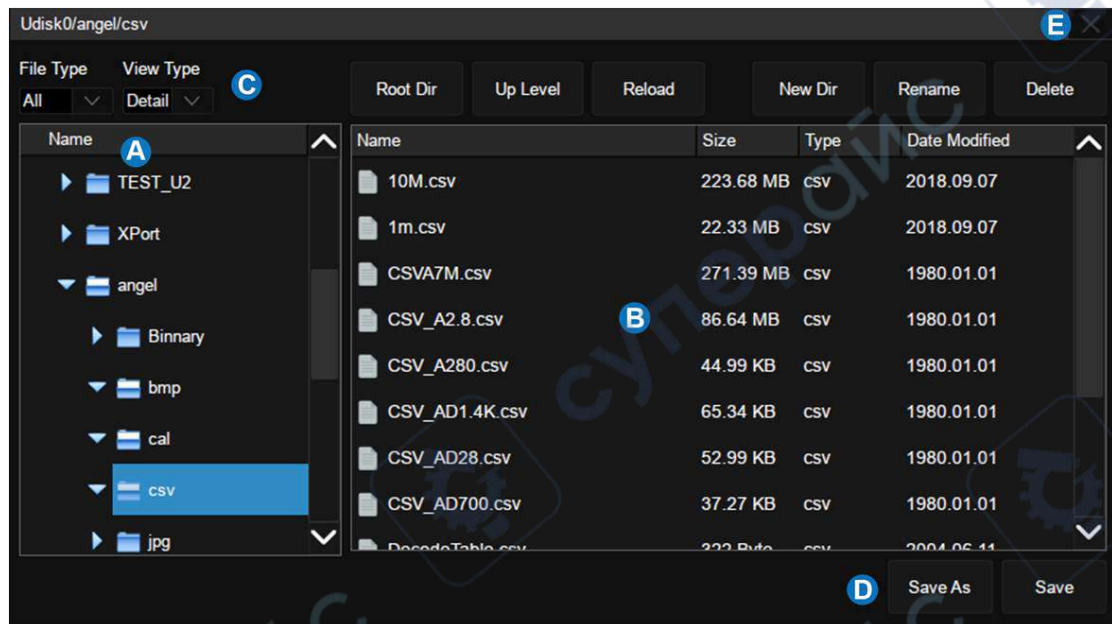

- A. Left window
- B. Right window
- C. Toolbar
- D. Save/Recall command bar
- E. Close the file manager

Left window: Displays a list of available drives and internal folders.

- The selected folder has an icon with a blue background.
- The triangle tag on the left of the folder indicates that the folder includes subfolder(s). Clicking the tag expands the folder to show the subfolder(s) in the left window.

Right window: Displays the files and the subfolders contained in the selected folder.

Toolbar: Graphical commands for file operations.

- **File Type:** Specify the file type to display, including All (all types), *.xml, *.ref, *.bmp, *.jpg, *.png, *.csv, *.dat, *.bin, *msk, *smk
- **View Type:** Contains two modes of "Detail" and "Icon"

Name	Size	Type	Date Modified
10M.csv	223.68 MB	csv	2018.09.07
1m.csv	22.33 MB	csv	2018.09.07
CSVA7M.csv	271.39 MB	csv	1980.01.01
CSV_A2.8.csv	86.64 MB	csv	1980.01.01
CSV_A280.csv	44.99 KB	csv	1980.01.01
CSV_AD1.4K.csv	65.34 KB	csv	1980.01.01
CSV_AD28.csv	52.99 KB	csv	1980.01.01
CSV_AD700.csv	37.27 KB	csv	1980.01.01
DecodeTable.csv	223.68 MB	csv	2018.09.07

Detail View Type

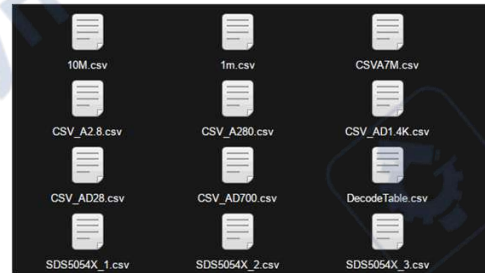

Icon View Type

- **Root Dir:** Jump to root directory quickly
- **Up Level:** Return to upper-level folder
- **Reload:** Refresh file manager view
- **New Dir:** Create a new folder under the current path
- **Rename:** Rename the selected file or folder
- **Delete:** Delete the selected file or folder

Save/Recall command bar - Execute the Save/Recall command

- **Save As:** Save as the filename specified by the user. Visible when the mode is "Save"
- **Save:** Save as system default file name. Visible when the mode is "Save"
- **Recall:** Recall the specified file. Visible when the mode is "Recall"

29.3.2 External Save and Recall Instance

Save the screenshot to the path “Udisk0\sds2kxplus\” in the format of BMP

First, Insert the U disk.

Secondly, set the parameters of the Save operation:

- Select *Mode* as “Save”
- Select *Type* as “BMP”
- Select the *Image Style*. “Normal” saves images with the same color of the display; “Inverted” saves images with a white background color for ink-saving print
- Touch *File Manager* to open the file manager

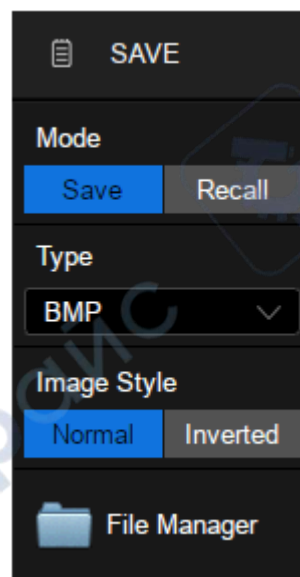

Third, select the \Udisk0\sds2kxplus\ directory in the file manager:

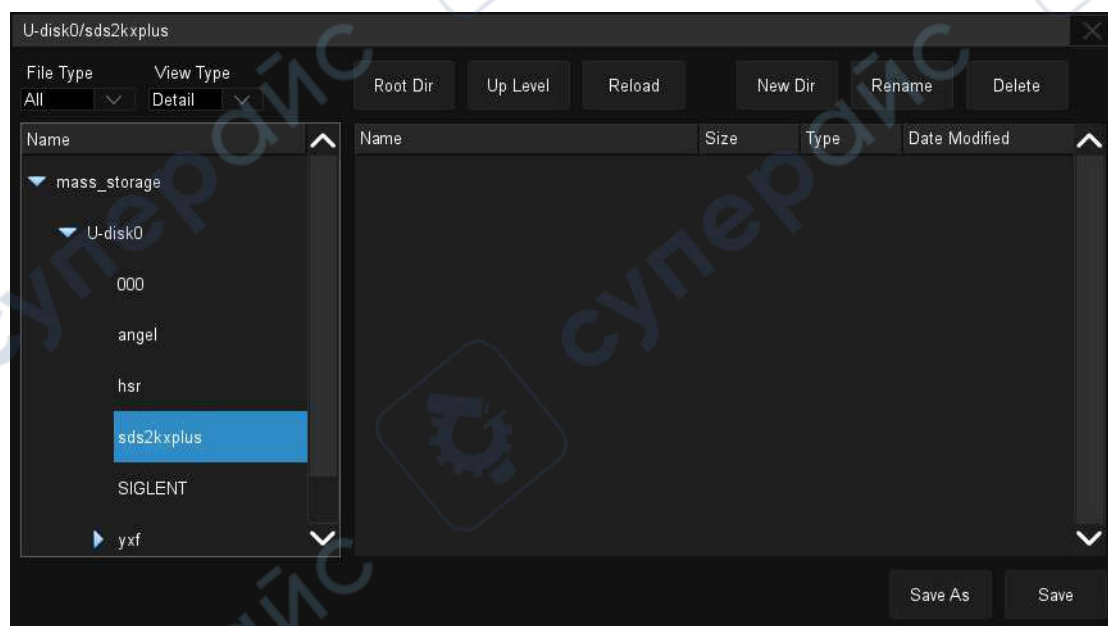

Fourth, touch *Save As*, click the pop-up text box to recall the virtual keyboard and input the file name, and then touch *OK*:

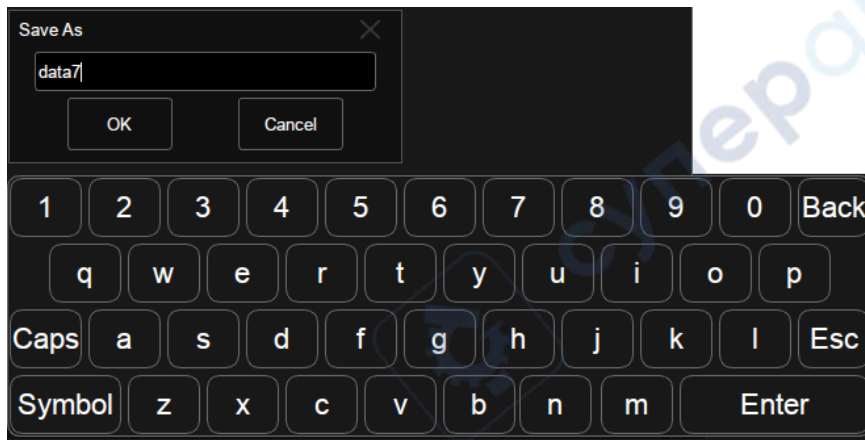

Once saved, the new BMP file is visible in the file manager:

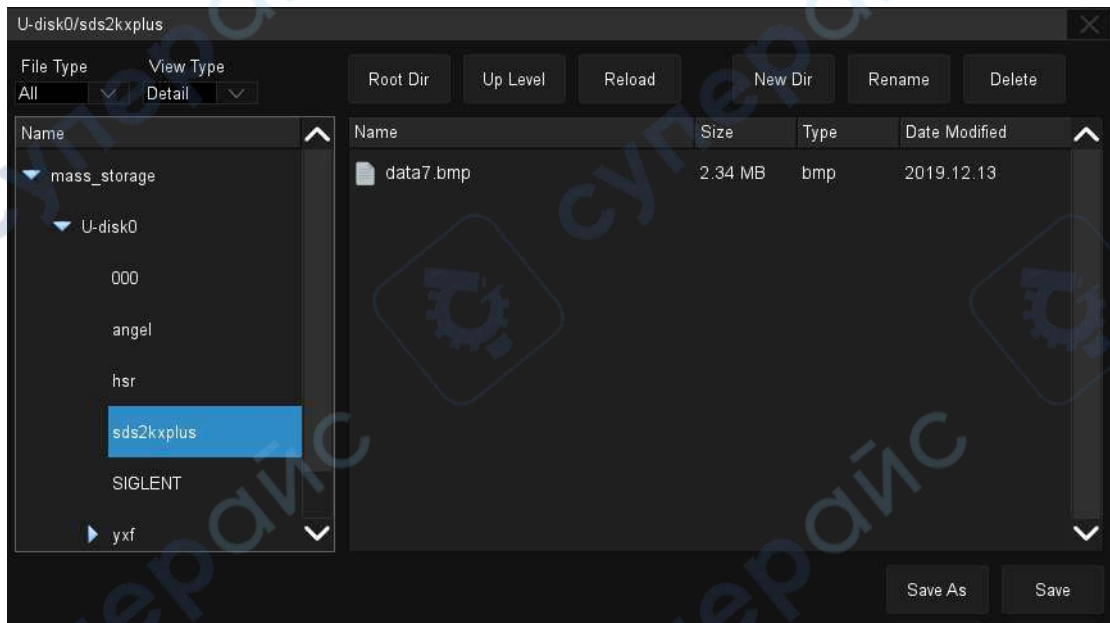

In step 4, if *Save* is selected instead of *Save As*, the system saves the file as the default file name sds2000X Plus_BMP_n.bmp, where n is an integer incrementing from 1. The default save path is \SIGLENT\.

Note: Pressing the **Print** button on the front panel quickly saves a screenshot to the U disk.

Recall the setup file "uart_decode.xml" stored in the path
"Udisk0\sds2kxplus\"

First, insert the U disk with the file "uart_decode.xml" stored folder
"\sds2kxplus\" .

Second, set the parameters of the Recall operation:

- Select *Mode* as "Recall"
- Select *Type* as "Setup"
- Select *Recall Path* as "External"
- Touch *File Manager* to open the file manager

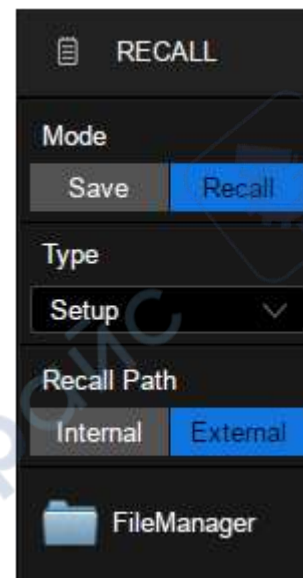

Third, select the \Udisk0\sds2kxplus\ directory in the file manager,
and then select the setup file "uart_decode.xml"

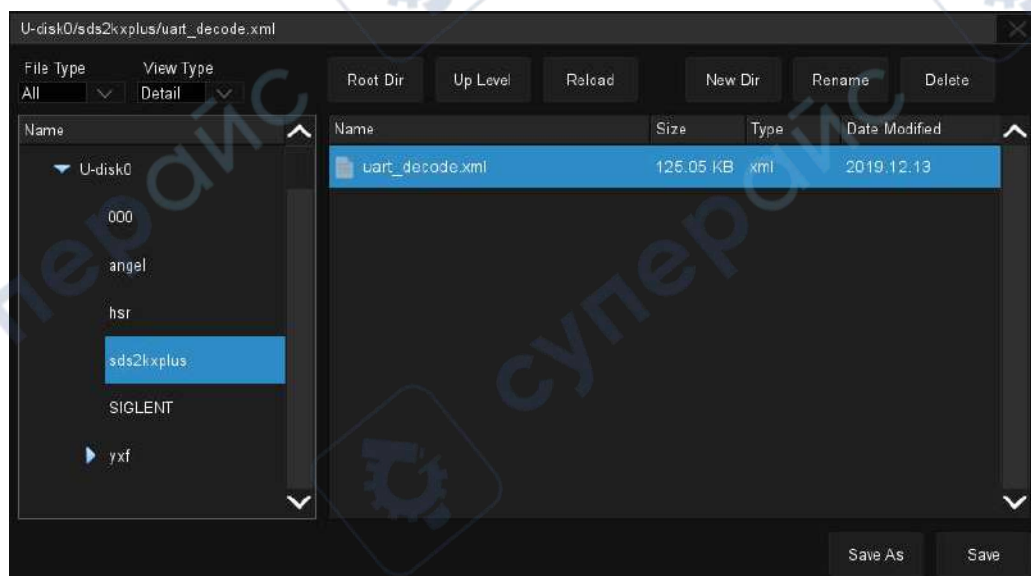

Fourth, touch *Recall* and wait for the oscilloscope to finish recalling
the setup.

30 System Setting

Most of the system settings can be found in the Utility dialog box, such as system status, language, sound, self-calibration, firmware upgrading.

30.1 System Status

Operate **Utility** > *System Setting* > *System Status* to check the system status.

System information includes the contents shown below.



30.2 Sound

Perform **Utility** > *System Setting* > *Sound* to enable or disable the audible buzzer.



: Indicates the buzzer is on.



: Indicates the buzzer is off.

30.3 Upgrade Software

The firmware is upgradeable through external USB memory devices/U disk. Make sure the U disk contains the correct upgrade file (*.ads) is connected to the oscilloscope before performing the upgrade.

Operate **Utility** > *System Setting* > *Upgrade* to recall the upgrade dialog box:

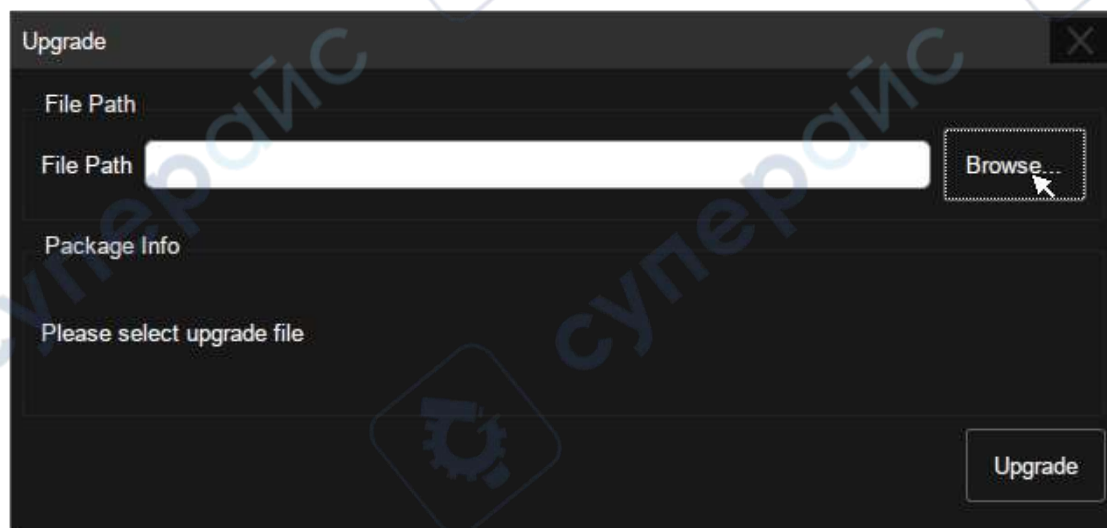

Click *Browse* to open the file manager, select the correct upgrade file and click *OK*:

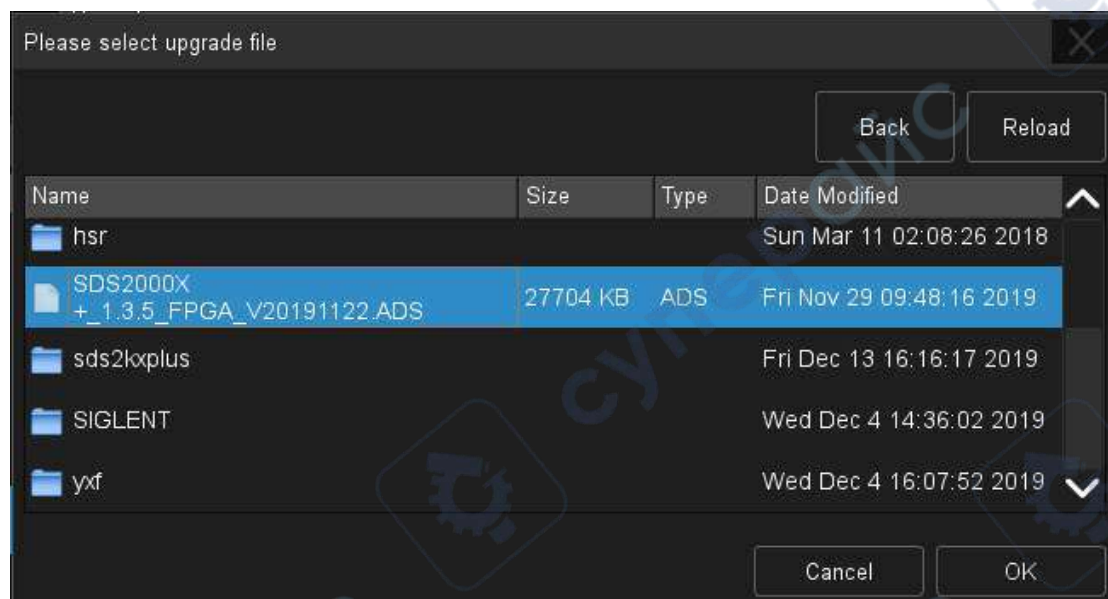

Click *Upgrade* in the upgrade dialog box to start the upgrade. The oscilloscope first copies the upgrade file (*.ads) to the local memory and parses it. If the parse succeeds, it will show the following dialog. Users can choose *Cancel* to cancel the upgrade or *Reboot* to restart the oscilloscope immediately and continue the upgrade. Otherwise, the oscilloscope will restart automatically to finish the upgrade.

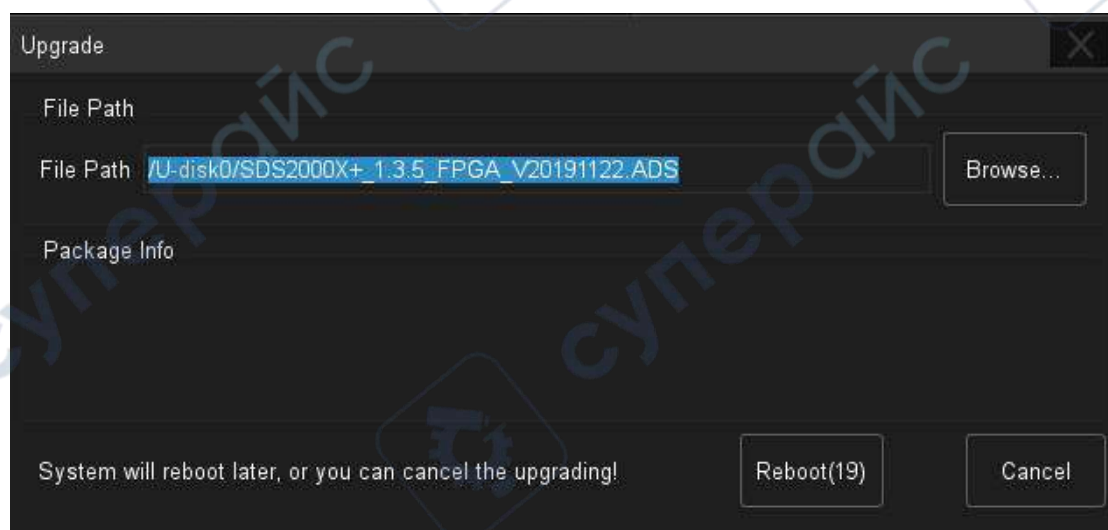

After the reboot, check the version number in "System Status".



Warning: Do Not turn off the power during upgrading. Otherwise, the oscilloscope may not boot up anymore!

30.4 Language

The SDS2000X Plus supports multiple languages, including: Simplified Chinese, Traditional Chinese, English, French, Japanese, German, Spanish, Russian, Italian, Portuguese, and so on.

Operate **Utility** > *System Setting* > *Language*, and select the language in the list.

30.5 Screen Saver

The screen saver will be activated if the oscilloscope has not been operated for a set period of time. At this time the backlight of the display is cut off to save power consumption.

Operate **Utility** > *System Setting* > *Screen Saver* to specify the period before screen saver, or select "Off" to disable the screen saver.

Any action from the mouse, touch screen or front panel can disable the screen saver.

30.6 I/O Setting

30.6.1 LAN

Operate the following steps to set the LAN port:

Perform **Utility** > *System Setting* > *I/O Setting* > *LAN Config* to open the LAN Config dialog box.

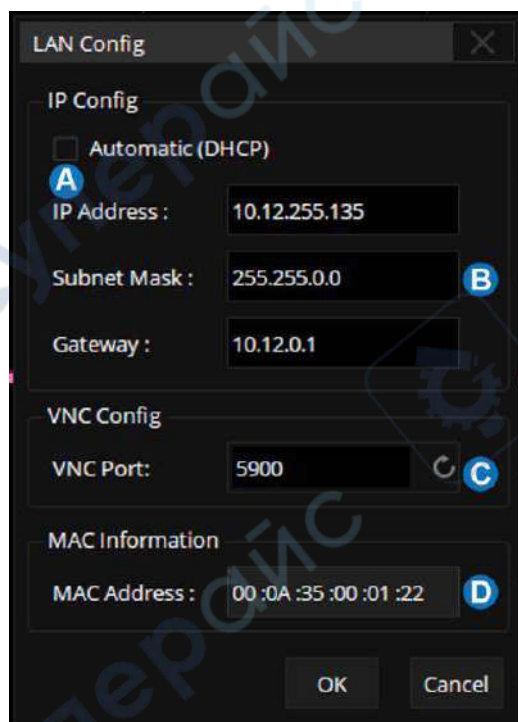

- A. Check *Automatic (DHCP)* to enable dynamic IP. In this case, the oscilloscope must be connected to the local area network with a DHCP server. Contact your network administrator to confirm the relevant information.
- B. When **A** is not checked, the oscilloscope uses static IP. Set the static IP address, subnet mask, and gateway separately.
- C. When accessing more than two SIGLENT instruments through the web browser, it is necessary to set a different VNC port number for each instrument. The range is from 5900 to 5999.
- D. MAC address of the oscilloscope, read only.

30.6.2 Web Server

The SDS2000X Plus supports the web server function, the oscilloscope can be accessed and controlled using a web browser. See the section "Remote Control" for details about remote control.

Perform **Utility** > *System Setting* > *I/O Setting* > *Web Server* to set the password to control the instrument. The password length is limited to 20 bytes.

30.7 Date/Time

The SDS2000X Plus has an RTC clock, which helps to record absolute time information for screenshots, history frames and so on.

Operate **Utility** > *System Setting* > *Date/Time* to open the Date/Time dialog box:

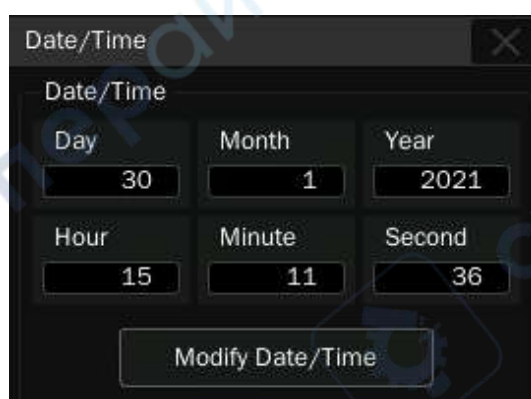

Touch the text box of Hour, Minute, Second, Day, Month and Year to edit these fields. Touch the *Modify* button to perform the change.

30.8 Install Options

The SDS2000X Plus provides a few options to enhance its functionality. Contact your local **SIGLENT** sales representative or **SIGLENT** technical support to get the corresponding option key. Perform the following steps to install the option:

Utility > Options

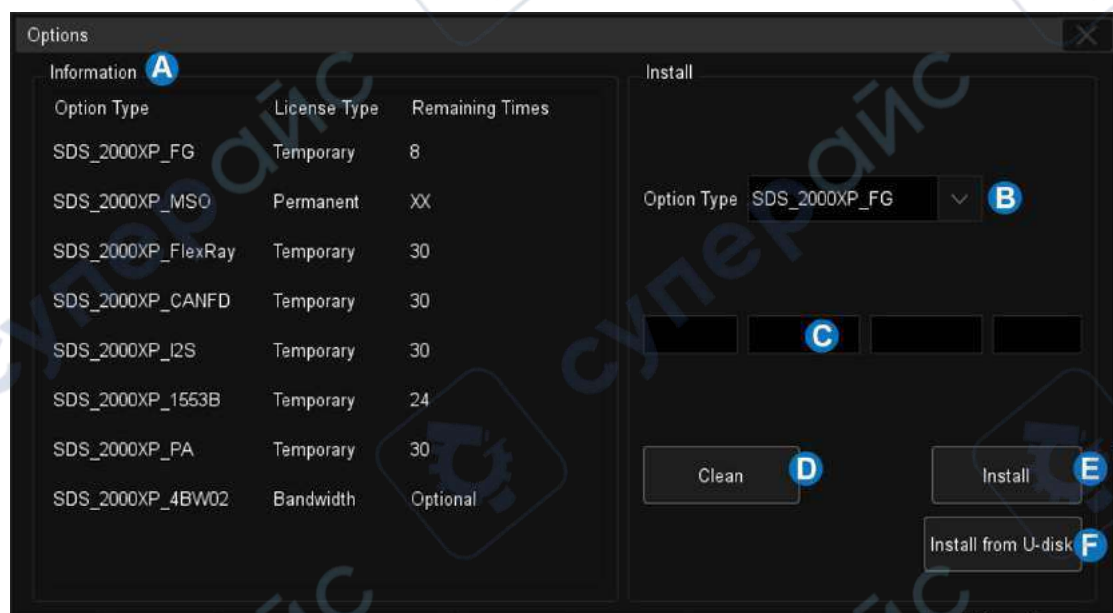

- A. Option information display area. When the option is not activated, the license type is displayed as "Temporary" and can be tried up to 30 times.
- B. Select the option to install.
- C. The option key input area, touch or click the text box and enter the key by the virtual keyboard.
- D. Clear the characters in the key input area.
- E. After entering the option key, click *Install* to perform the installation.

- F. Use the U-disk to automatically install the option, the license must be stored in the root directory of the U-disk.

30.9 Reference Position Setting

The reference position is used to set the strategy of scaling on the horizontal and vertical axes, adapting different requirements.

Operate **Utility** > *Reference Pos* to open the dialog box, and choose the strategy for the offset value change in the vertical (or horizontal) direction when the vertical (or horizontal) scale is changed.

Horizontal Ref

- **Fixed Delay:** When the timebase is changed, the horizontal delay value remains fixed. As the horizontal timebase scale is changed, the waveform expands/contracts around the center of the display
- **Fixed Position:** When the timebase is changed, the horizontal delay remains fixed to the grid position on the display. As the horizontal timebase scale is changed, the waveform expands/contracts around the position of the horizontal display.

Vertical Ref

- **Fixed Offset:** When the vertical scale is changed, the vertical offset remains fixed. As the vertical scale is changed, the waveform expands/contracts around the main X-axis of the display
- **Fixed Position:** When the vertical scale is changed, the vertical offset remains fixed to the grid position on the display. As the vertical scale is changed, the waveform

expands/contracts around the position of the vertical ground position on the display.

Take Horizontal Ref as an example to demonstrate the scaling effect of different settings:



Timebase = 10 ns/div, Horizontal Delay = -20 ns = -2 div



Fixed position, timebase is changed to 5 ns/div, the grid number of delay (-2 div) remains fixed, while the horizontal delay changes to -10 ns

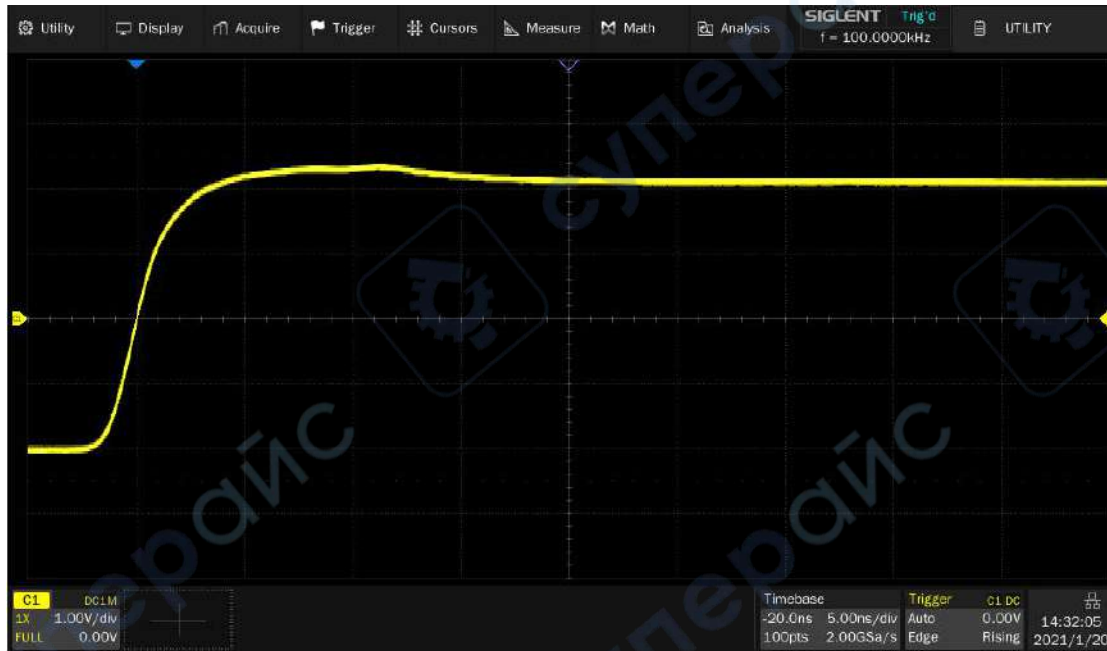

Fixed delay, timebase is changed to 5 ns/div, the horizontal delay value remains fixed, while the grid number of delay changes to -4 div

30.10 Perform Self-Test

The Self-tests include a screen test, keyboard test and LED test. It is used to check whether the oscilloscope has any electrical or mechanical problems on the user interface such as color distortion, the sensitivity of buttons and knobs.

Screen Test

The screen test is used to find out whether the oscilloscope display has serious color distortion, bad pixels or screen scratches. Perform **Utility** > *Do Self-Test* > *Screen Test*, and the oscilloscope will enter the screen test interface as shown below. The screen displays in blue at first.



Press the "Single" button to switch to red and green display mode. Observe whether there is any color distortion, bad pixel or scratch on the screen.

Press the "Run/Stop" button to exit the screen test mode.

Keyboard Test

The keyboard test is used to check whether the oscilloscope front panel buttons or knobs are responsive or sensitive. Perform **Utility** > **Do Self-Test** > **Keyboard Test** to recall the following interface:

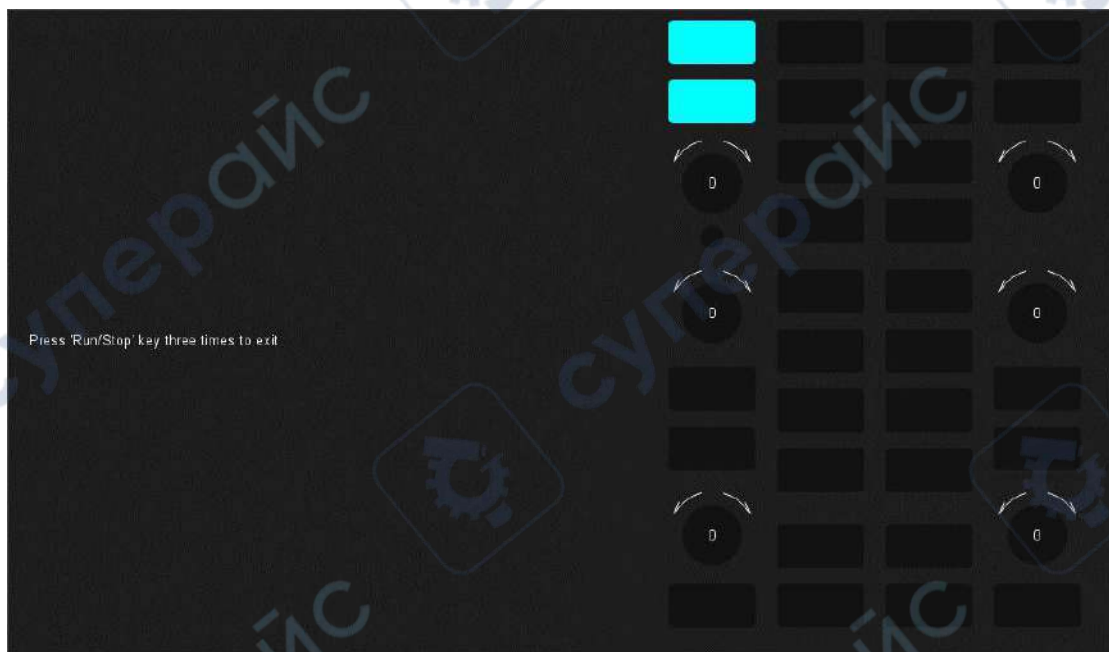

Knob test: Turn each knob clockwise, counter-clockwise, and press down. Observe whether the value on the corresponding knob (default 0) on the screen increases or decreases in real-time and whether the knob lights up when it is pressed.

Button test: Press each button and check whether the corresponding button icon on the screen lights up in real-time.

Press the "Run/Stop" button three times to exit the keyboard test.

LED Test

The LED test is used to check whether the button backlight on the front panel is functional. Operate **Utility** > *Do Self-Test* > *LED Test* to recall the following interface:



Press the "Single" button and the first LED on the front panel will light. The corresponding position of the key on the screen will also change color. Press the "Single" button to check the next button. Press the "Single" button consecutively until all the backlights are tested.

Press the "Run/Stop" button to exit the LED test.

30.11 Do Self Cal

The self-calibration program can quickly calibrate the oscilloscope to reach the best working state and the most precise measurement. It is recommended to perform a self-calibration if the change of ambient temperature is more than 5 °C.

Note: Make sure the oscilloscope has been warmed up or operated for more than 30 minutes before the self-calibration.

Please do the self-calibration as follows:

1. Disconnect everything from all inputs.
2. Operate **Utility** > *Do Self Cal*, and it will pop up the following dialog. Select *Continue* to start the self-cal program.

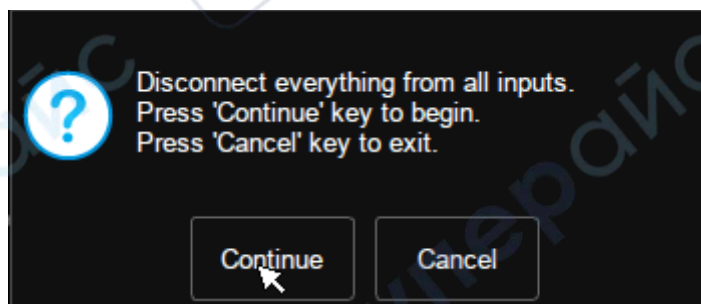

3. The oscilloscope will not respond to any operation until the self-cal is finished. After the self-cal is completed, touch the screen or press any button to exit.

30.12 Power on Line

Operate **Utility** > *Power on Line* to set. See the chapter "Power on" for details.

30.13 Debug

This function is used for the internal development of SIGLENT engineering and has no user purpose.

31 Remote Control

The SDS2000X Plus provides a LAN port and a USB Device port which can be used for remote control in multiple ways.

31.1 Web Browser

A built-in web server provides an approach to control the oscilloscope by a web browser. It doesn't require any additional software to be installed on the controlling computer. Set the LAN port correctly (see section "LAN" for details), input the IP address of the oscilloscope in the browser address bar, and then the user can browse and control the oscilloscope in the web.



- Input the IP address of the instrument
- Instrument Information
- Click here to recall the instrument control interface

Below is the instrument control interface:

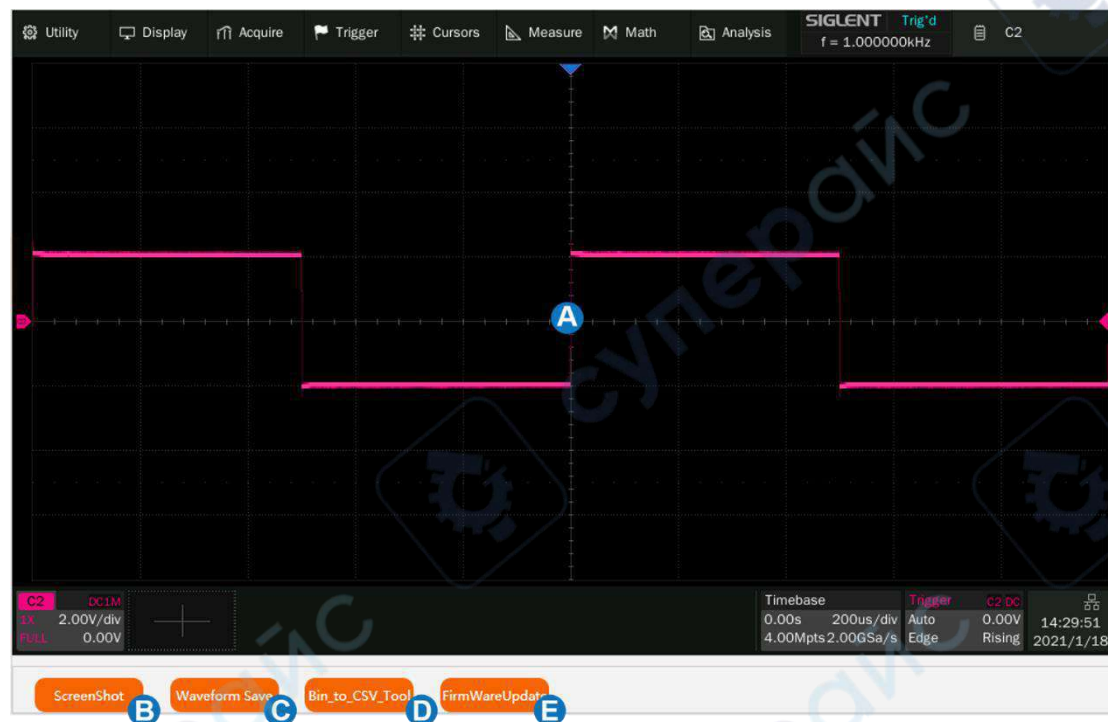

- A. Display and control area of the instrument. The display in this area is a copy of the instrument display. Using the mouse to operate in the area is equivalent to directly operating the touch screen display of the instrument.
- B. Click here to perform a screenshot
- C. Click here to save the waveform data as a binary (*.bin) file and download it to the local computer
- D. Click here to download an executable program that converts binary waveform files (*.bin format) files to csv files.
- E. Click here to perform a firmware upgrade

31.2 Other Connectivity

The SDS2000X Plus also supports remote control of the instrument by sending SCPI commands via NI-VISA, Telnet, or Socket. For more information, refer to the programming guide of this product.

32 Troubleshooting

The commonly encountered failures and their solutions are listed below. When you encounter those problems, please solve them following the corresponding steps. If the problem remains still, please contact **SIGLENT** as soon as possible.

1. The screen is still dark (no display) after power on:
 - 1) Check whether the power is correctly connected.
 - 2) Check whether the power switch is really on.
 - 3) Check whether the fuse is burned out. If the fuse needs to be changed, please contact **SIGLENT** timely and return the instrument to the factory for replacement by the maintenance personnel authorized by **SIGLENT**.
 - 4) Restart the instrument after finishing the above inspections.
 - 5) If it still does not work correctly, please contact **SIGLENT**.

2. The signal is sampled but no waveform of the signal is displayed:
 - 1) Check whether the probe is correctly connected to the signal connecting wire.
 - 2) Check whether the signal connecting wire is correctly connected to the BNC (namely channel connector).
 - 3) Check whether the probe is correctly connected to the item to be tested.
 - 4) Check whether there are signals generated from the item to be tested.

- 5) Resample the signal.
-
3. The tested voltage amplitude is greater or lower than the actual value (Note that this problem usually occurs when a probe is used):
 - 1) Check whether the attenuation coefficient of the channel complies with the attenuation ratio of the physical probe.
 - 2) Disconnect the oscilloscope from the external signal and do a self-cal.

 4. There is a waveform displayed but it is not stable. The waveform moves across the display over time:
 - 1) Check the trigger signal source: Check whether the source item at the trigger panel complies with the signal channel actually used.
 - 2) Check whether it is a "false wave": When the signal frequency is very large (more than half of the sample rate), it is easy to appear a "false wave". At this point, a small time base should be set to make the sample rate more than 2 times of the signal frequency.
 - 3) Check the trigger type: General signals should use "Edge" trigger and video signals should use "Video" trigger. Only when the proper trigger type is used, can the waveform be displayed stably.
 - 4) Change the trigger holdoff setting.

5. No display after pressing **Run/Stop**:

Check whether the mode at the trigger panel (TRIGGER) is on “Normal” or “Single” and whether the trigger level exceeds the waveform range. If yes, set the trigger level to the middle or set the mode to “Auto”.

Note: Using **AutoSetup** could automatically finish the above setting.

6. Touch screen does not respond to touch operation:

- 1) Check whether the **Touch** button backlight on the front panel is lighted up. If not, the touch screen is not turned on. Press the button to enable the touch screen
- 2) Restart the instrument.

7. The USB storage device cannot be recognized:

- 1) Check whether the USB storage device can work normally.
- 2) Make sure whether the USB interface can work normally.
- 3) Make sure that the USB storage device being used is a flash storage type (USB memory sticks, thumb drives, etc.). This oscilloscope does not support hardware storage types like stand-alone disk drives.
- 4) Make sure that the U disk system format is FAT32.
- 5) Restart the instrument and then insert the USB storage device to check it.
- 6) If the USB storage device still cannot be used normally, please contact **SIGLENT**.



About SIGLENT

SIGLENT is an international high-tech company, concentrating on R&D, sales, production and services of electronic test & measurement instruments.

SIGLENT first began developing digital oscilloscopes independently in 2002. After more than a decade of continuous development, SIGLENT has extended its product line to include digital oscilloscopes, isolated handheld oscilloscopes, function/arbitrary waveform generators, RF/MW signal generators, spectrum analyzers, vector network analyzers, digital multimeters, DC power supplies, electronic loads and other general purpose test instrumentation. Since its first oscilloscope was launched in 2005, SIGLENT has become the fastest growing manufacturer of digital oscilloscopes. We firmly believe that today SIGLENT is the best value in electronic test & measurement.

Headquarters:

SIGLENT Technologies Co., Ltd
Add: Bldg No.4 & No.5, Antongda Industrial
Zone, 3rd Liuxian Road, Bao'an District,
Shenzhen, 518101, China
Tel: + 86 755 3688 7876
Fax: + 86 755 3359 1582
Email: sales@siglent.com
Website: int.siglent.com

North America:

SIGLENT Technologies America, Inc
6557 Cochran Rd Solon, Ohio 44139
Tel: 440-398-5800
Toll Free: 877-515-5551
Fax: 440-399-1211
Email: info@siglentna.com
Website: www.siglentna.com

Europe:

SIGLENT Technologies Germany GmbH
Add: Staetzlinger Str. 70
86165 Augsburg, Germany
Tel: +49(0)-821-666 0 111 0
Fax: +49(0)-821-666 0 111 22
Email: info-eu@siglent.com
Website: www.siglenteu.com

Follow us on
Facebook: SiglentTech

