

SPS5000X Series Wide Range Programmable Switching DC Power Supplies

User Manual



Contents

INTRODUCTION.....	4
IMPORTANT SAFETY INFORMATION.....	5
GENERAL SAFETY SUMMARY	5
SAFETY TERMS AND SYMBOLS	6
WORKING ENVIRONMENT	7
COOLING REQUIREMENTS.....	8
AC POWER AND GROUND CONNECTIONS	9
OUTPUT PORT CONNECTIONS	10
CLEANING	10
ABNORMAL CONDITIONS	11
DOCUMENTATION CONVENTIONS	12
INFORMATIONS ESSENTIELLES SUR LA SÉCURITÉ	13
EXIGENCE DE SÉCURITÉ.....	13
TERMES ET SYMBOLES DE SÉCURITÉ	14
ENVIRONNEMENT DE TRAVAIL	15
EXIGENCES DE REFROIDISSEMENT.....	17
CONNEXIONS D'ALIMENTATION ET DE TERRE	17
CONNEXION DU PORT DE SORTIE	18
NETTOYAGE.....	19
CONDITIONS ANORMALES.....	19
DELIVERY OF THE POWER SUPPLY	21
ABOUT WARRANTY	21
MAINTENANCE AGREEMENT	22
INTRODUCTION OF SPS5000X SERIES	23
PERFORMANCE AND FEATURES	24
MODEL INTRODUCTION	25
SIZE 26	
SPS5000X SERIES OVERVIEW	29
APPEARANCE	29
REAR PANEL	32
THEORY OF OPERATION	35
OPERATING AREA DESCRIPTION	35
CC AND CV MODE	35
SLEW RATE	36
BLEEDER CONTROL.....	37
INTERNAL RESISTANCE	38
ALARMS	39
CONSIDERATIONS.....	39
<i>Inrush current</i>	39
<i>Pulsed or Peaked loads</i>	40

Reverse current regenerative load.....	40
Reverse current connection method.....	41
Grounding.....	41
SWITCH ON / OFF AND OUTPUT PORT	43
CONNECT THE POWER CORD.....	43
POWER ON	43
POWER OFF.....	44
OUTPUT PORT	44
USER INTERFACE.....	46
BASIC OPERATION.....	48
SYSTEM SETTINGS	48
View Version Information.....	48
System Upgrade.....	48
Restore Default.....	49
Beeper Setup	49
Parallel/Series Operation.....	49
FUNCTION SETTINGS	63
Set List Function.....	63
Set OCP/OVP.....	67
Set Bleeder Resistor Control.....	67
Set CC/CV Priority	67
Set Output On/Off Delay Time	68
Set Internal Resistance.....	69
Set Measurement Accuracy.....	69
External Analog Control.....	70
External Control Output On/Off.....	71
Multi-channel Settings.....	73
Analog Interface.....	74
Save/Recall.....	76
COMMUNICATION INTERFACE SETTINGS.....	77
REMOTE CONTROL	78
WAY TO CONTROL.....	78
GRAMMATICAL CONVENTIONS	79
COMMAND SUMMARY	80
COMMAND DESCRIPTION.....	80
IEEE Common Command Subsystem	80
Measure Command Subsystem.....	83
Configure Configuration Command Subsystem.....	84
List Configuration Command Subsystem	91
System Configuration Command Subsystem.....	95
WEB SERVICE	98
List operation method:.....	101
List file export	103
TROUBLESHOOTING.....	104



Introduction

This user manual includes important safety and installation information related to the SPS5000X series wide range programmable Switching DC Power Supply and includes simple tutorials for basic operation of the supply.

The series includes the following models:

Model	Output parameters
SPS5041X	40 V/30 A/360 W
SPS5042X	40 V/60 A/720 W
SPS5043X	40 V/90 A/1080 W
SPS5044X	2-channel, 40 V/30 A/360 W/CH
SPS5045X	3-channel, 40 V/30 A/360 W/CH
SPS5051X	50 V/10 A/180 W
SPS5081X	80 V/15 A/360 W
SPS5082X	80 V/30 A/720 W
SPS5083X	80 V/45 A/1080 W
SPS5084X	2-channel, 80 V/15 A/360 W/CH
SPS5085X	3-channel, 80 V/15 A/360 W/CH
SPS5161X	160 V/7.5 A/360 W
SPS5162X	160 V/15 A/720 W
SPS5163X	160 V/22.5 A/1080 W
SPS5164X	2-channel, 160 V/7.5 A/360 W/CH
SPS5165X	3-channel, 160 V/7.5 A/360 W/CH

Important Safety Information

This manual contains information and warnings that must be followed by the user for safe operation and to keep the product in a safe condition.

General Safety Summary

Carefully read the following safety precautions to avoid personal injury and prevent damage to the instrument and any products connected to it. To avoid potential hazards, please use the instrument as specified.

To avoid fire or personal injury, use the proper power cord.

Only use the state/locally approved power cord with the instrument. Sold to North America and other countries, it will be equipped with power cord meeting local requirements.

**Warning:**

Do not use removable power cords with insufficient ratings.

Ground the instrument.

The instrument grounds through the protective terra conductor of the power line. To avoid electric shock, the ground conductor must be connected to the earth. Make sure the instrument is grounded correctly before connect its input or output terminals.

Review all terminal ratings before use.

To avoid fire or electrical shock, please look over all ratings and instructions for the instrument. Before connecting the instrument, please read the manual carefully to gain more information about the ratings and important use instructions for safe operation.

Do not operate with suspected failures.

If you suspect that there is damage to the instrument, halt use and contact your local SIGLENT dealer immediately.

Do not operate in wet/damp conditions.







Do not operate in an explosive atmosphere.

Keep the surface of the instrument clean and dry.

Anyone operating this equipment should refer to the instruction manual to understand the protection afforded by the equipment. Please use the instrument only in accordance with regulations.

Safety Terms and Symbols

When the following symbols or terms appear on the front or rear panel of the instrument or in this manual, they indicate special care in terms of safety.

	This symbol is used where caution is required. Refer to the accompanying information or documents to protect against personal injury or damage to the instrument.
	This symbol warns of a potential risk of shock hazard.
	This symbol is used to denote the measurement ground connection.
	This symbol is used to denote a safety ground connection.
	This symbol shows that do not put electronic equipment as unsorted municipal waste management. Please separate collection or contact equipment suppliers.
	This symbol is used to represent an alternating current, or "AC".
CAUTION	The " CAUTION " symbol indicates a potential hazard. It calls attention to a procedure, practice, or condition which may be dangerous if not followed. Do not proceed until its conditions are fully understood and met.
WARNING	The " WARNING " symbol indicates a potential hazard. It calls attention to a procedure, practice, or condition which, if not followed, could

	cause bodily injury or death. If a WARNING is indicated, do not proceed until the safety conditions are fully understood and met.
--	---

Working Environment

The design of the instrument has been verified to conform to EN 61010-1 safety standard per the following limits:

Environment

This instrument is intended for indoor use and should be operated in a clean, dry environment.

Ambient temperature

Operating: 0 °C to +50 °C

Non-operation: -20 °C to +60 °C

Note: Direct sunlight, radiators, and other nearby heat sources should be taken into account when assessing the ambient temperature.

Relative Humidity

Operating: 20% to 85% RH, 40 °C, 24 hours

Non-operating: 20% to 85% RH, 65 °C, 24 hours

Altitude

Operating: ≤ 2,000 m

Overvoltage category

This product is intended to be powered by MAINS that comply with Overvoltage Category II, which is typical of cord-and-plug connected equipment.

Note:

Measurement Category II. For measurements performed on circuits directly connected to the low-voltage installation.

Measurement Category III. For measurements performed in the building installation.

Measurement Category IV. For measurements performed at the source of low-voltage installation.

Only mains power supply circuits have an overvoltage category rating.

Degree of pollution

The power supply may be operated in environments of Pollution Degree II.

Note:

Degree of Pollution II refers to a working environment that is dry and non-conductive pollution occurs. Occasional temporary conductivity caused by condensation is expected.



Do not dispose of electronic equipment in unsorted municipal waste. To reduce the impact on the environment, please separate collection processing or contact equipment suppliers.

IP rating

IP20 (as defined in IEC 60529).

Cooling requirements

This instrument relies on forced air cooling with internal fans and ventilation openings.

Care must be taken to avoid restricting the airflow around the apertures (fan holes) at the back of the power supply. Please keep good ventilation when using, and regularly check the vents and fans.



CAUTION: Do not block the ventilation holes located on the back of the power supply.



CAUTION: Do not allow any foreign matter to enter the power supply through the ventilation holes, etc.

AC Power and ground connections

The instrument operates with a single-phase, 100 to 240 Vrms (+/-10%) AC power at 47 to 63 Hz (+/-5%)

To avoid electrical shock, always use a grounded power plug.

No manual voltage selection is required because the instrument automatically adapts to line voltages with the following specifications:

Voltage range: 90 to 264 Vrms, Frequency range: 47 to 63 Hz.



CAUTION: When using the power supply in the United Kingdom, ensure the security of the power cord conforms to the following instructions

Wire colors must meet the following rules:

Black/Brown: Live wire

Green/Green-yellow: Earth wire

White/Blue: Neutral wire



American Standard



European standard



Back view

The wire which is coloured Black(American Standard) or Brown(European standard)should

be connected to lug labeled with the letter L.

The wire which is coloured Green(American Standard) or Green-yellow(European standard) should be connected to the earth symbol  .

The wire which is coloured White(American Standard) or Blue(European standard) should be connected to lug labeled with the letter N.

Finally, fix the metal cover on the casing with screws and tighten the black fixing parts.

Wire connections must be made by a professional. If you have questions, please refer to the instructions or contact your local SIGLENT dealer.

Output Port connections

Make sure to turn off the power before connecting the cable to the output port, install the plastic protective shell and tighten the screws.



Output port connections



Warning: The power switch must be turned off before installing wiring at the power output terminal. The plastic protective shell must be installed before turning on the power supply.

Otherwise, there may be a risk of electric shock.

The front and rear outputs cannot be used at the same time. When the front output is connected with the load, the rear port should not be connected with the load.

Cleaning

Clean only the exterior of the instrument, using a damp, soft cloth. Do not use chemicals or abrasive elements. Under no circumstances should you allow moisture to penetrate the instrument. To avoid electrical shock, unplug the power cord from the AC outlet before cleaning.



Warning: Electrical Shock Hazard!

No operator serviceable parts inside. Do not remove covers.

Refer servicing to qualified personnel

Abnormal conditions

Only operate the instrument for the purposes specified by the manufacturer.

Do not operate the power supply if there are any visible signs of damage or if it has been subjected to severe transport stresses.

If you suspect the power supply's protection has been impaired, disconnect the power cord, and secure the instrument against any unintended operation.



Proper use of the instrument requires reading and understanding all of the instructions and labels.

If the equipment is used in a manner not specified by the manufacturer, the protection provided by the equipment may be impaired.



Warning: Any use of the power supply in a manner not specified by the manufacturer may impair the instrument's safety protection.

Documentation conventions

For the symbols appearing in the subsequent text, the convention with  represents the menu option on the front panel of the machine, the convention with  represents the menu option displayed by the machine, and the convention with  represents the selected item of the machine menu.

Informations essentielles sur la sécurité

Ce manuel contient des informations et des avertissements que les utilisateurs doivent suivre pour assurer la sécurité des opérations et maintenir les produits en sécurité.

Exigence de Sécurité

Lisez attentivement les précautions de sécurité ci - après afin d'éviter les dommages corporels et de prévenir les dommages aux instruments et aux produits associés. Pour éviter les risques potentiels, utilisez les instruments prescrits.

Éviter l'incendie ou les lésions corporelles.

Utilisez une ligne d'alimentation appropriée.

Seules les lignes d'alimentation en électricité réservées à l'usage exclusif d'instruments reconnus au niveau local peuvent être utilisées. Vendue en Amérique du Nord et dans d'autres pays, elle sera équipée de lignes électriques répondant aux exigences locales.



WARNING:

N'utilisez pas de cordon d'alimentation amovible de faible puissance.

Posez vos instruments par terre.

L'appareil est mis à la Terre par des conducteurs terra protecteurs de lignes électriques. Pour éviter le contact électrique, le fil de masse doit être mis à la terre. Avant de connecter les bornes d'entrée ou de sortie, assurez - vous que l'instrument est correctement mis à la terre.

Connectez correctement la ligne de signal.

Le potentiel de la ligne de signaux est égal à la terre, de sorte que la ligne de signaux ne doit pas être connectée à une haute tension. Ne touchez pas les contacts ou les composants nus.

Affiche la valeur nominale de toutes les bornes.

Pour éviter les incendies ou les coupures d'électricité, consultez toutes les valeurs nominales et signez la description de l'instrument. Avant de connecter l'instrument, lisez attentivement le Manuel pour obtenir davantage d'informations sur la valeur nominale.

Ne pas travailler en cas de panne.

Si vous soupçonnez que l'appareil est endommagé, demandez au personnel d'entretien qualifié de l'examiner.

Ne pas fonctionner dans des conditions humides / humides.







Pas dans un environnement explosif.

Maintenez la surface de l'instrument propre et sec.

L'organisme ou l'opérateur responsable doit se référer au cahier des charges pour protéger la protection offerte par le matériel. Veuillez utiliser l'instrument prescrit.

Termes et symboles de sécurité

Lorsque les symboles ou termes suivants apparaissent sur le panneau avant ou arrière de l'instrument ou dans ce manuel, ils indiquent un soin particulier en termes de sécurité.

	Ce symbole est utilisé lorsque la prudence est requise. Reportez-vous aux informations ou documents joints afin de vous protéger contre les blessures ou les dommages à l'instrument.
	Ce symbole avertit d'un risque potentiel de choc électrique.
	Ce symbole est utilisé pour désigner la connexion de terre de mesure.
	Ce symbole est utilisé pour indiquer une connexion à la terre de sécurité.
	This symbol shows that do not put electronic equipment as unsorted municipal waste management. Please separate collection or contact equipment suppliers.
	Ce symbole est utilisé pour représenter un courant alternatif, ou "AC".
CAUTION	Le symbole " CAUTION " indique un danger potentiel. Il attire l'attention sur une procédure, une pratique ou une condition qui peut être dangereuse si elle n'est pas suivie. Ne continuez pas tant que ses conditions n'ont pas été entièrement comprises et remplies.
WARNING	Le symbole " WARNING " indique un danger potentiel. Il attire l'attention sur une procédure, une pratique ou une condition qui, si elle n'est pas suivie, pourrait entraîner des blessures corporelles ou la mort. Si un AVERTISSEMENT est indiqué, ne continuez pas tant que les conditions de sécurité ne sont pas entièrement comprises et remplies.

Environnement de travail

La conception de l'instrument a été certifiée conforme à la norme EN 61010-1, sur la base des valeurs limites suivantes:

Environnement

Cet instrument est utilisé à l'intérieur des locaux et doit être utilisé dans un environnement propre et sec.

Température ambiante

En fonctionnement: 0 °C à +50 °C

Hors fonctionnement: -20 °C à +60 °C

Note: pour évaluer la température de l'environnement, il convient de tenir compte des rayonnements solaires directs, des radiateurs thermiques et d'autres sources de chaleur.

Humidité

Fonctionnement: 20 à 85% HR, 40 °C, 24 heures

Hors fonctionnement: 20 à 85% HR, 65 °C, 24 heures

Altitude

Fonctionnement: ≤ 2000m

À l'arrêt: ≤ 15 266 m

Catégorie d'installation (surtension)

Ce produit est alimenté par une alimentation électrique conforme à l'installation (surtension) Catégorie II.

Installation (overvoltage) Category Definitions Définition de catégorie d'installation (surtension)

La catégorie II d'installation (surtension) est un niveau de signal applicable aux terminaux de mesure d'équipement reliés au circuit source. Dans ces bornes, des mesures préventives sont prises pour limiter la tension transitoire à un niveau inférieur correspondant.

La catégorie II d'installation (surtension) désigne le niveau local de distribution d'énergie d'un équipement conçu pour accéder à un circuit alternatif (alimentation alternative).

Degré de pollution

Alimentation électrique peut être utilisé dans un environnement Pollution Degree II.

Note: Pollution Degree II signifie que le milieu de travail est sec et qu'il y a une pollution non conductrice. Parfois, la condensation produit une conductivité temporaire.

IP Rating

IP20 (as defined in IEC 60529).

Exigences de refroidissement

L'appareil repose sur un ventilateur interne et un ventilateur de ventilation. Attention. Des mesures doivent être prises pour éviter de limiter le flux d'air autour de l'ouverture arrière de l'alimentation (orifice de ventilateur). Gardez une bonne ventilation lors de l'utilisation et vérifiez régulièrement les ventilateurs et les ventilateurs.



ATTENTION: Ne bloquez pas les orifices de ventilation de l'arrière de l'alimentation.



ATTENTION: Ne laissez aucun objet étranger entrer dans l'alimentation électrique, par exemple par le trou de ventilation.

Connexions d'alimentation et de terre

L'instrument fonctionne avec une alimentation CA monophasée de 100 à 240 Vrms (+/- 10%) à 47 à 63Hz (+/- 5%).

Les bornes de mise à la terre de protection des prises d'alimentation en courant alternatif sont mises à la terre afin d'éviter les chocs électriques.

Il n'est pas nécessaire de sélectionner la tension manuellement, car l'instrument s'adapte automatiquement à la tension du circuit.

L'instrument s'adapte automatiquement aux entrées de lignes de communication dans les limites suivantes:

Plage de tension: 90 à 264 vrms, plage de fréquence: 47 à 63 Hz.



ATTENTION: Lorsque le Royaume - Uni utilise l'énergie électrique, la sécurité des lignes électriques est assurée conformément à la description ci - après.

La couleur du fil doit être conforme aux règles suivantes:

Noir / brun: conducteur vivant

Vert / vert - jaune: sol

Blanc / bleu: neutre



Normes américaines



Normes européennes

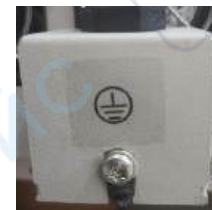

Vue arrière

Les fils noirs (norme américaine) ou bruns (norme européenne) doivent être raccordés aux languettes marquées de la lettre L.

Le conducteur vert (norme américaine) ou vert - jaune (norme européenne) doit être relié au symbole de mise à la terre .

Les fils blancs (norme américaine) ou bleus (norme européenne) doivent être raccordés aux languettes marquées de la lettre N.

Le câblage doit être effectué par un professionnel. Si vous avez des questions, consultez les instructions ou contactez votre revendeur siglent local.

Connexion du port de sortie

Assurez - vous d'éteindre l'alimentation avant de connecter le câble au port de sortie, d'installer un boîtier de protection en plastique et de serrer les vis.



Connexion du port de sortiet



Avertissement: L'interrupteur d'alimentation doit être éteint avant que le câblage ne soit installé à la sortie d'alimentation. Un boîtier de protection en plastique doit être installé avant que l'alimentation ne soit allumée.

Sinon, il peut y avoir un risque de choc électrique.

Les sorties avant et arrière ne peuvent pas être utilisées simultanément. Lorsque la sortie actuelle est connectée à la charge, le port arrière ne doit pas être connecté à la charge.

Nettoyage

Nettoyez uniquement l'extérieur de l'instrument à l'aide d'un chiffon doux et humide.

N'utilisez pas de produits chimiques ou d'éléments abrasifs. Ne laissez en aucun cas l'humidité pénétrer dans l'instrument. Pour éviter les chocs électriques, débranchez le cordon d'alimentation de la prise secteur avant de le nettoyer.



Avertissement: risque de choc électrique!

Aucune pièce réparable par l'opérateur à l'intérieur. Ne retirez pas les capots.

Confiez l'entretien à un personnel qualifié

Conditions anormales

Utilisez l'instrument uniquement aux fins spécifiées par le fabricant.

N'utilisez pas la lunette s'il y a des signes visibles de dommages ou si elle a été soumise à de fortes contraintes de transport.

Si vous doutez que la protection de l'alimentation électrique soit compromise, désactivez la ligne d'alimentation et fixez l'appareil afin d'éviter toute manipulation accidentelle.

Une bonne utilisation de l'instrument nécessite la lecture et la compréhension de toutes les instructions et étiquettes.

La protection offerte par le matériel peut être compromise si celui - ci est utilisé de manière non spécifiée par le fabricant.



Avertissement: L'utilisation de l'énergie de manière non prescrite par le fabricant peut compromettre la sécurité des instruments.

Delivery of The Power Supply

- **General Inspection**

Note: Before your first use of the equipment, please check the condition using the steps below.

- **Inspection of transport packaging**

If it is found that the packing box or foam plastic pad is seriously damaged, please save it for subsequent inspection. The carrier and shipper must be contacted for any damage caused during transport. The SIGLENT company is not responsible for any damage caused during shipment.

- **Check the equipment**

If there is mechanical damage, missing parts, or the instrument fails to pass the electrical and mechanical tests, please contact the nearest SIGLENT office or distributor as soon as possible.

- **Check the accessories**

Detailed information about included accessories is included at the end of this document. Please refer to this description to check whether the attachment is delivered completely. If there is any omission or damage, please contact the local SIGLENT customer service center or national distributors. If you fail to contact us in time in case of omission or damage, we will not be responsible for replacement.

About Warranty

The power supply has a 3-year warranty for normal use and operation from the date of delivery. SIGLENT may repair or choose to replace any product returned to the authorized service center during the warranty period. But to do so, we must first examine the product

to determine that the defect is caused by the process or material, not by abuse, negligence, accident, abnormal conditions, or operation.

SIGLENT is not responsible for any situation caused by any defect, damage or malfunction caused by the following:

- a) Maintenance or installation by personnel other than those authorized by SIGLENT
- b) Connection of incompatible equipment and improper connection
- c) Any damage or failure caused by the use of products not supplied by SIGLENT suppliers.

Also, SIGLENT will not be responsible for the maintenance of the modified or integrated power supply product if the product has been modified or integrated and these changes or integration increase the time or difficulty of power maintenance tasks.

All spare parts and replacement parts and maintenance are guaranteed for 90 days.

The power supply software has been fully tested and is considered to be functioning properly. However, the software is provided without any type of warranty covering detailed performance. Products not manufactured by SIGLENT are guaranteed by the OEM only.

Maintenance Agreement

We provide various services based on individual maintenance agreements. We offer extended warranties which can extend the warranty period beyond the standard period. We provide installation, training, enhancement and on-site maintenance and other services through a dedicated supplemental support agreement. For details, please contact your nearest SIGLENT customer service center or national distributors.

Introduction of SPS5000X Series

The SIGLENT SPS5000X series is a programmable DC switching power supply with single/multiple outputs and constant power features. The series includes 16 models, with 40 V, 50V, 80 V, 160 V rated output voltage values and 180W, 360 W, 720 W, 1080 W maximum output power levels. Users can connect 2 sets of power supplies in series or up to 3 sets in parallel. This series of products can meet the user's combination selection of 0 ~ 320 V, 0 ~ 270 A, and the maximum combined power can reach up to 3240 W, meeting different application requirements.

SPS5000X series programmable DC switching power supply is equipped with a 2.4-inch high brightness OLED display, friendly human-computer interaction interface, and excellent performance indicators. The minimum resolution is 1mV / 1mA. The output voltage and current rise time is adjustable. It has two output modes: Constant voltage and constant current. It also supports list sequence programming mode. It also has over-voltage, over-current, power limit and over-temperature protection, high-precision, low-noise, and high-reliability.

Standard LAN / USB communication interface, analog control interface, the product can be remotely controlled through web pages. It can be widely used in a variety of demanding testing places, such as general laboratory testing, LED lighting industry, automotive electronics, and other fields.



Performance and Features

- Rated voltage: 40 V, 50V, 80 V, 160 V
- Rated output power: 180W, 360 W, 720 W, 1080 W
- Constant power output, a wide range of voltage and current outputs, high efficiency switching power supply
- CV, CC priority mode selection, better protection for the circuit/DUT
- Fast recovery time, < 1 ms
- Fast output response time, < 1 ms
- Voltage and current rise/fall rate adjustable
- Set and read back resolution 1 mV, 1 mA
- Built-in bleeder current control, the power in the output capacitor can be discharged below the circuit/DUT safe voltage after shutdown
- Support remote voltage compensation Sense function
- Support local list function editing, USB import list sequence file
- External analog voltage and resistance control, voltage and current monitoring output
- Overvoltage, over current, power limit, over-temperature protection, safe and reliable
- 2.4-inch OLED high-brightness display with a wide viewing angle of 170 degrees
- Equipped with USB, LAN standard communication interface, optional USB-GPIB module
- With 1/2, 1/3, 1/6 rack size, flexible assembly
- Embedded web server provides remote computer by web browser without the need to install additional software on the host computer

Model Introduction

The SPS5000X series includes 16 models, with four voltage output types of 40V / 50V / 80V / 160V, with up to three output channels:

Model	Type	Channels	Voltage (V)	Current (A)	Power (W)
SPS5041X	I	1	0~40	0~30	360
SPS5042X	II	1	0~40	0~60	720
SPS5043X	III	1	0~40	0~90	1080
SPS5044X	IV	2	0~40/CH	0~30/CH	360/CH
SPS5045X	V	3	0~40/CH	0~30/CH	360/CH
SPS5051X	I	1	0~50	0~10	180
SPS5081X	I	1	0~80	0~15	360
SPS5082X	II	1	0~80	0~30	720
SPS5083X	III	1	0~80	0~45	1080
SPS5084X	IV	2	0~80/CH	0~15/CH	360/CH
SPS5085X	V	3	0~80/CH	0~15/CH	360/CH
SPS5161X	I	1	0~160	0~7.5	360
SPS5162X	II	1	0~160	0~15	720
SPS5163X	III	1	0~160	0~22.5	1080
SPS5164X	IV	2	0~160/CH	0~7.5/CH	360/CH
SPS5165X	V	3	0~160/CH	0~7.5/CH	360/CH

Size

The numbers marked in the pictures are in millimeters

1) Front dimension drawing of single module

SPS5041X , SPS5051X, SPS5081X, SPS5161X

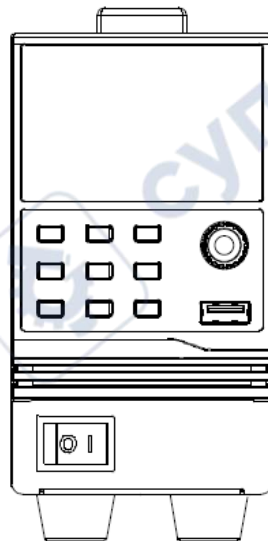
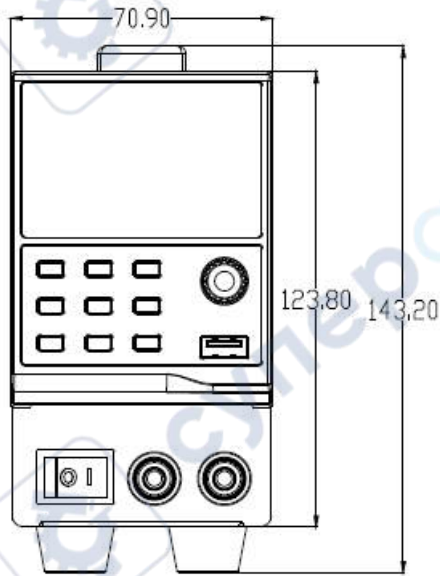

2) Front dimension drawing of dual module

SPS5042X, SPS5044X, SPS5082X, SPS5084X, SPS5162X, SPS5164X

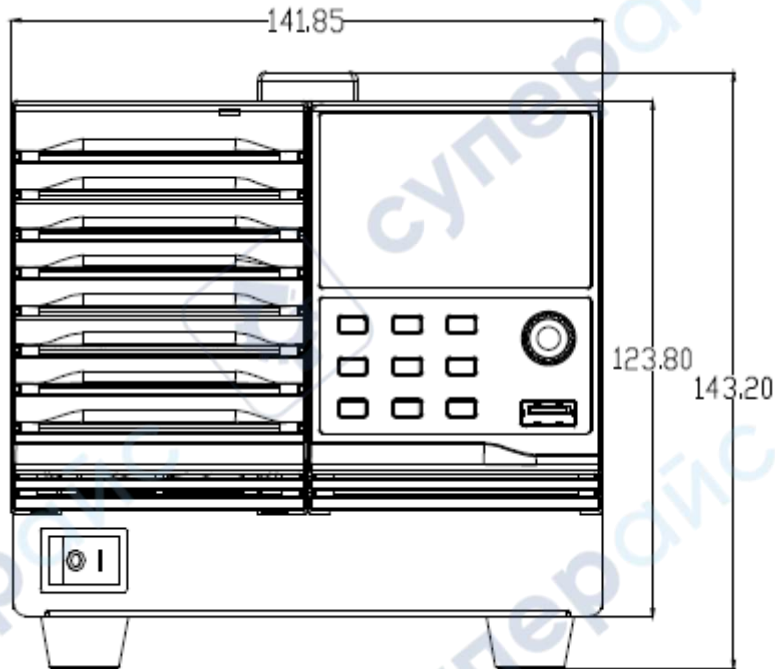

3) Three module frontal dimension drawing

SPS5043X, SPS5045X, SPS5083X, SPS5085X, SPS5163X, SPS5165X

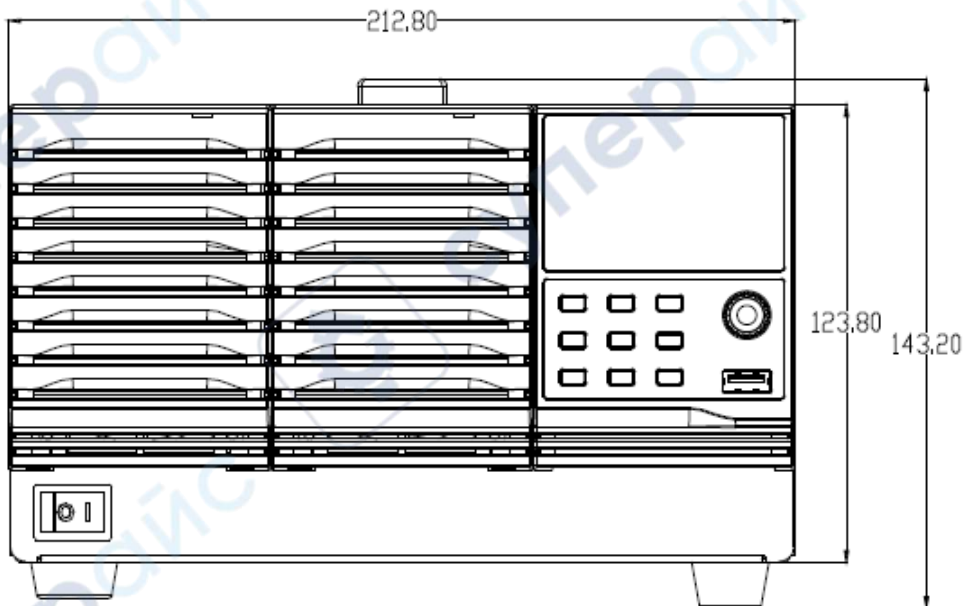

4) Side dimension drawing with front output port

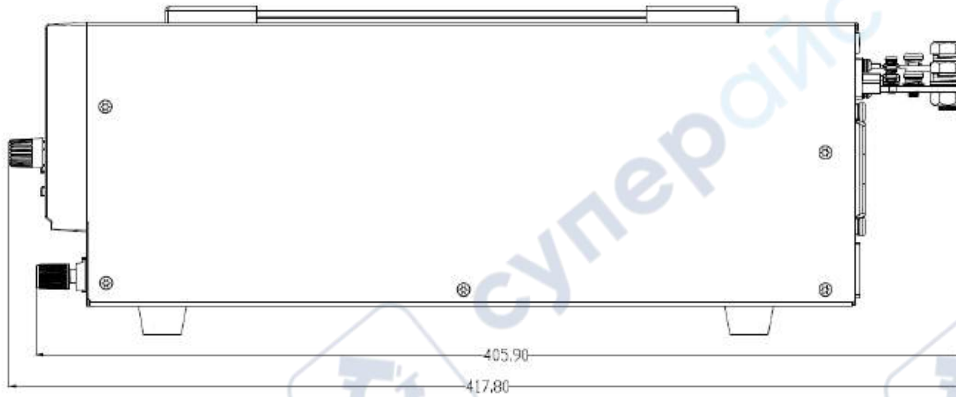

5) The side dimensions of other models are shown in the figure below, except that the rack dimensions of the models with front output ports are slightly different

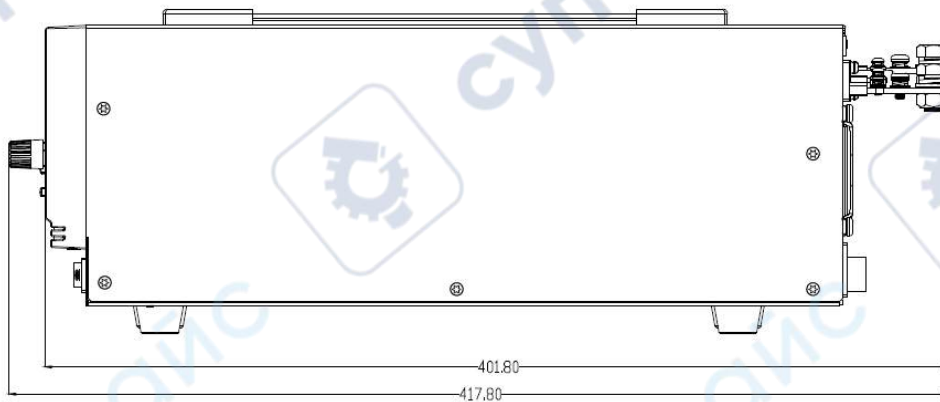

SPS5000X Series Overview

Appearance

The SPS5000X series has three different appearance panels, distinguished by Type I , Type II/TypeIV, TypeIII/Type V :

Type I



Type II/TypeIV:









Type III/Type V







A Screen

All SPS supplies include a 2.4-inch OLED display for displaying system output status, system parameter settings, menu options, and promotion information.

B Button

	<p>Used to view system information and configure power parameters.</p>
	<p>(V/I) In the main interface, press this key to select and set the output voltage value or output current value.</p>
	<p>Press this key in the function area to enter the next menu, which is equivalent to the confirm key.</p>
	<p>Press Menu to enter the menu list, press this key to return to the previous menu.</p>
	<p>When the power supply enters the protection state, long press the key to release the protection mode</p>
	<p>Press this key to enter the List mode, you can set each group of output current, output voltage and running time, etc.</p>
	<p>Press this key again to exit the List interface</p>

	Press this key to turn on the keyboard lock function, long press to release the key lock.
	Used to recall or store the state. If you select List, press this key to store or recall the List state.
	Power output button used to turn the output on or off.
	The direction buttons are used to switch the digits of the value where the cursor is selected, and to move the cursor position or switch options.

C Direction knob

When setting parameters, turn the knob to increase or decrease the value at the cursor.

When setting objects (voltage or current, operation mode, internal resistance configuration, etc.), rotate the knob to quickly move the cursor position or switch options, press the knob to set the current parameters, rotate the knob to increase or decrease the value at the cursor, and press again to make the current setting effective.

D USB Host port

Used to insert peripheral USB devices for file transfer and system upgrades.

F Power Switch

Used to turn the power on or off.

H Front output port (positive (+), negative (-))

The current output front port can output a maximum current of 10 A.

Rear Panel

Type I



Type II



Type III



Type IV



Type V

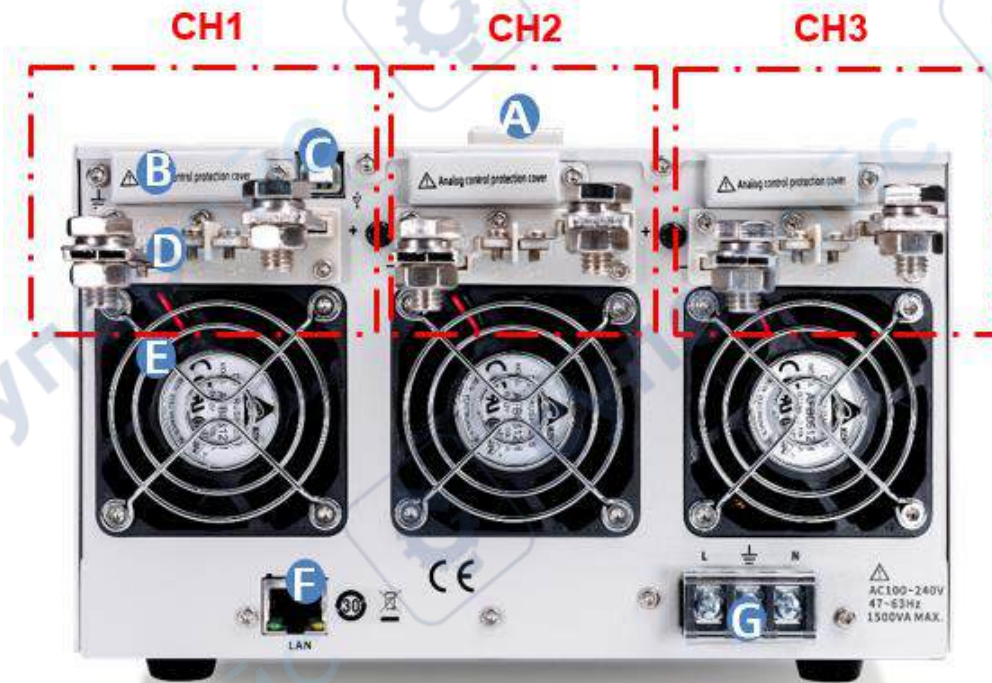

B Analog connector port

Output for the monitor signals of voltage and current output. Also used for analog control of the current and voltage outputs.

C USB Device port

This interface can be connected to a PC for remote communication via USB using the USBTMC protocol. Provides remote computer control of the supply by sending commands through computer software.

D Output Interface

One set of positive (+) and negative (-) output terminals, type IV has two output ports, and type V has three output ports. On units with multiple output channels, the channels are arranged as follows (when facing the rear panel): From right to left, the one near the display is CH1, then CH2, CH3.

E Fan port

The temperature-controlled fan effectively dissipates the heat of the power supply line over all operating conditions.

F LAN port

Supplies a connection between the power supply and a LAN. SPS5000X conforms to the VXI-11 instrument standard and supports Socket-based and remote commands, and remote control. It can quickly build a test system with other standard equipment and easily achieve system integration.

G AC power interface

The AC power supply supports 100 ~ 240 V, 47 Hz ~ 63 Hz. Please use the provided power cord to connect to MAINS. For different types of power interface connections, please refer to [7.1].

Theory of Operation

This chapter introduces the function and principles of operating the SPS5000X series power supply.

Operating Area Description

SPS5000X are DC switching power supplies with high voltage and current output. All models have continuous voltage (CV) and continuous current (CC) output control modes with working ranges limited only by the output power. The working area is determined by the rated output power and the rated voltage and current.

When the total output power of the power supply (voltage x current output) is less than the rated power output, the SPS operates as a typical constant voltage and constant current power supply.

When the total output power (voltage x current output) is greater than the rated power output, the effective output is limited to 105% of the rated power. At this time, the output voltage and current are only related to the load value as shown below:

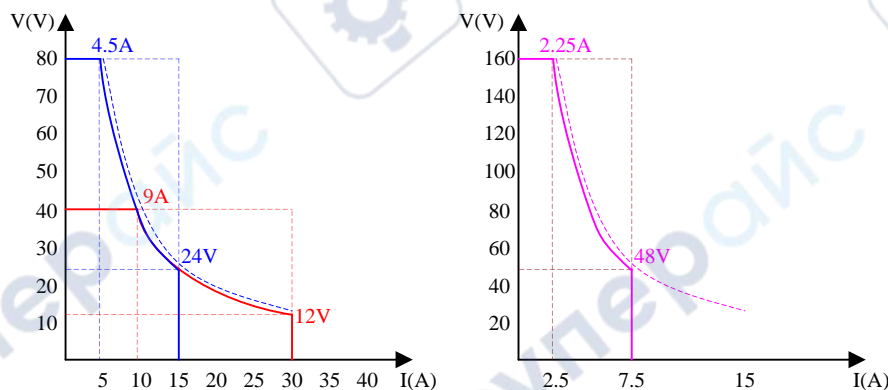

CC and CV Mode

When the power supply is operating in CV mode, the load receives a constant voltage, and the current output changes with the load. When the load resistance is too low to maintain

the constant voltage, the power supply switches to CC mode, and the current limit remains constant.

When the power supply is operating in constant current mode (CC), the load receives constant current. Even if the output voltage is changed, the current remains the same. If the load resistance increases to the current limit (I_{set}) or greater, the power supply switches to CV mode. This switching point is called the crossover point, and the local state is displayed as ALT.

The power supply operates in CV or CC mode, which is determined by the set voltage (V_{set}), set current (I_{set}), load resistance (R_L) and critical resistance (R_c , $R_c = V_{set}/I_{set}$). When $R_L > R_c$, the power supply runs in CV mode. At this time, $V_{out} = V_{set}$, $I_{out} < I_{set}$. If R_L decreases, when $I_{out} = I_{set}$, the power supply switches to CC mode.

On the contrary, when the load resistance is less than the critical resistance, the power supply operates in CC mode. In CC mode, the output current is equal to I_{set} and the output voltage is less than V_{set} .



CV priority mode



CC priority mode

Slew Rate

The slope of CV and CC mode can be selected to limit the voltage and current consumption. The slope setting is divided into high-speed priority and slope priority. The high-speed priority mode does not allow setting the slope in CV or CC mode, while the rising and falling slopes can be set independently in the slope priority mode.

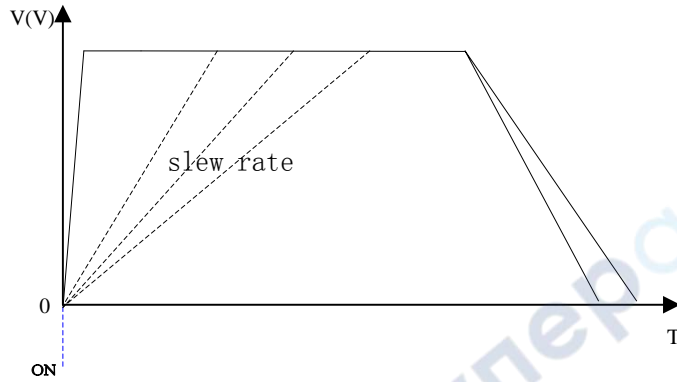

Bleeder Control

The SPS power supplies feature a bleeder resistor. When the power is turned off and the load is disconnected, the bleeder resistor will consume the power in the output capacitor. Without a bleeder resistor, the output capacitor would continue to be charged, causing potential danger.

The bleeder resistance can also play a role in smoothing the voltage regulation rate.

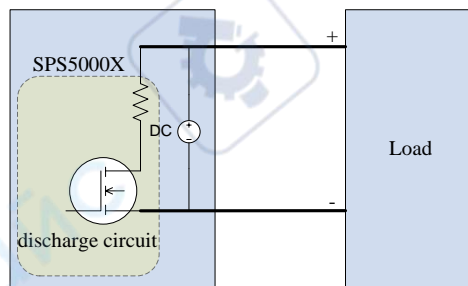

Bleeder circuit

Note

The bleeder resistor is turned on by default. In battery charging applications, make sure to turn off the bleeder resistor when the instrument is turned off because the bleeder resistor will discharge the connected battery.

Internal Resistance

The internal resistance can be customized in the configuration menu of the power supply. After setting, it can be regarded as a resistor in series with the positive output terminal. At this time, the power supply behaves like power source with internal resistance, such as a lead-acid battery.

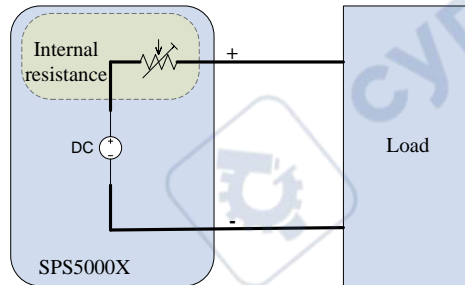

SPS Model	Internal Resistance Range
SPS5041X	0 ~ 1.5 Ω
SPS5042X	0 ~ 0.75 Ω
SPS5043X	0 ~ 0.5 Ω
SPS5044X	0 ~ 1.5 Ω
SPS5045X	0 ~ 1.5 Ω
SPS5051X	0 ~ 6 Ω
SPS5081X	0 ~ 6 Ω
SPS5082X	0 ~ 3 Ω
SPS5083X	0 ~ 2 Ω
SPS5084X	0 ~ 6 Ω
SPS5085X	0 ~ 6 Ω
SPS5161X	0 ~ 24 Ω
SPS5162X	0 ~ 12 Ω
SPS5163X	0 ~ 8 Ω
SPS5164X	0 ~ 24 Ω
SPS5165X	0 ~ 24 Ω

Alarms

The power supply has a protection function. When the protection alarm is set, the protection mechanism will be triggered and respond accordingly when the set conditions are reached.

OVP

The overvoltage protection (OVP) function prevents the load from being damaged by high voltage and triggers the output to be disconnected.

OCP

The overcurrent protection (OCP) function prevents the load from being damaged by high current and triggers the output to be disconnected.

OTP

Overtemperature protection function can prevent the instrument from overheating damage and automatically disconnect the output.

Alarm output

The alarm output is a separate open collector photocoupler output. When the protection settings (OCP, OVP, OTP) are exceeded, the power supply will automatically shut down and an alarm will be output via the analog control interface.

Considerations

The following conditions should be considered when using SPS power supplies:

Inrush current

The power supply generates an inrush current when it is turned on. Ensure that the power supply is sufficient at the moment of starting, especially when multiple power supplies are turned on at the same time.

**Note**

In a short time, the switching power supply will generate inrush current, reducing the service life of the power switch of the input fuse box.

Pulsed or Peaked loads

The load is subject to current peaks or pulses, and the maximum current may exceed the average current value. The power supplies only display the average current value. For pulsed current loads, the actual current may be greater than the displayed value. At this time, the current limit must be increased or the large power supply must be turned off.

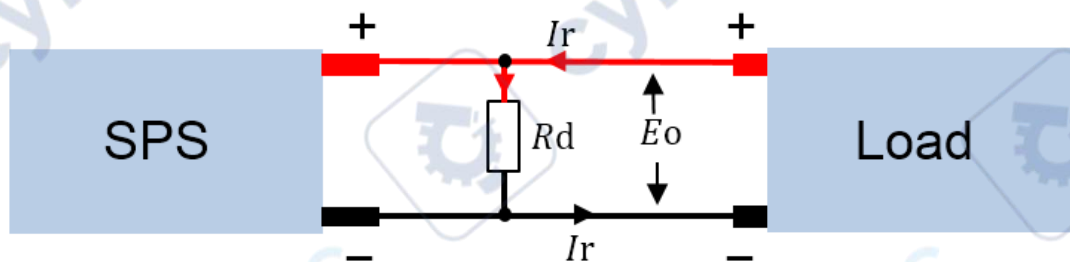
Reverse current regenerative load

When the power supplies are connected to regenerative loads (such as transformers and inverters), the reverse current will be fed back to the power supply and cannot be absorbed by the power supply. For such a load that can generate reverse current, a resistor must be connected in parallel with the power supply to avoid the inflow of reverse current. This method is only applicable when the bleeder resistor is closed.

To calculate the resistance value (R_d) of the virtual resistor, first determine the maximum reverse current I_r and determine the output voltage E_o .

$$R_d (\Omega) \leq E_o / I_r$$

**Note**

As the current decreases, the resistance of the output is partially absorbed.

Ensure that the resistor used can withstand the power

capacity of the power supply or load.

Reverse current connection method

When the power supplies are connected to a load such as a battery, reverse current may flow into the power supply. To prevent damage to the power supply, connect a reverse protection diode in series between the power supply and the load.

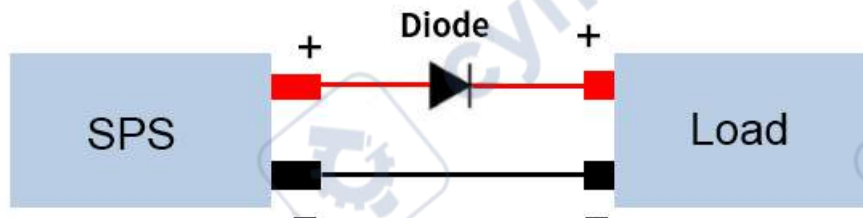

Note

Ensure that the reverse voltage of the protection diode can withstand 2 times the rated output voltage of the power supply and that it can withstand 3 ~ 10 times of the rated output current of the power supply in forward (conduction) current.

Ensure that the diode can withstand the subsequent heat generated by the maximum power that the supply can deliver.

When a diode is used to limit the reverse voltage, the remote measurement function should be turned off

Grounding

The output terminals of the power supplies are independent of the protective ground terminal. When in protective grounding or floating low, the insulation capacity of the load, load line, and other connected equipment must be considered.

Floating

When the output terminal is floating, the load and all load wires must be insulated, and the insulation capacity should be greater than the insulation voltage of the power supply.

Grounded output terminal

If the positive/negative terminal is connected to the protective ground terminal, the insulation capacity required by the load and the load line will be greatly reduced. The insulation capacity only needs to be greater than the maximum output voltage of the power supply.

**Note**

If using external voltage control, please do not ground the external voltage terminal, otherwise, it will cause a short circuit.

Switch On / Off and Output Port

Connect the Power Cord

Type I / type II / type IV supplies have a power interface with a 10 A input port: use the power cord provided to connect to the socket on the rear panel.

Type III / type V supplies have the following power cord connection method:

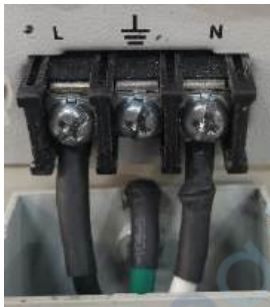

American Standard



European standard



Back view

- 1) Turn off the power switch;
- 2) Connect the AC input terminal to the AC power cord;
Black/Brown: The live/hot wire, connected to port L.
Green/Green-yellow: The ground wire is connected to the terminal with a grounding mark .
White/Blue: The neutral/zero line, connected to port N.
- 3) Install the protective cover.

Power On

The SPS5000X is powered on manually. After the power is connected to the AC power source through the power cord, manually press the power button to start the instrument and enter the boot interface.

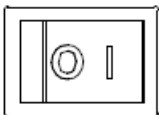

When the switch is in 1 state, it means that the switch is on. At this time, if there is sufficient AC power from MAINS, the power supply is in the on state.

**Note**

The power supplies generate an inrush current when turned on. Please make sure that the power supply is sufficient at the moment of turning on, especially when multiple power supplies are turned on at the same time.

Power Off

Press the switch button on the panel to set the 0 position to turn off the power.

**Warning**

It takes about 8 seconds for the power to be fully turned on and off.

Do not turn the power on and off quickly. Please wait at least 10 seconds before changing the output switch state.

Attention

When the power supply is on, quickly changing the output state may damage the power supply. Do not continuously change the output state of the supply.

Output Port

Before connecting the output terminal to the load, consider the cable specifications and the maximum voltage of the load. Connect the output terminal and load line with M4 screw or M8 bolt (> 30A). If remote voltage measurement is used, remove the connection terminals on S +, S - and output, and connect the S +, S - detection lines to the load. For the most accurate power delivery, connect the S+ and S- as close to the load as possible

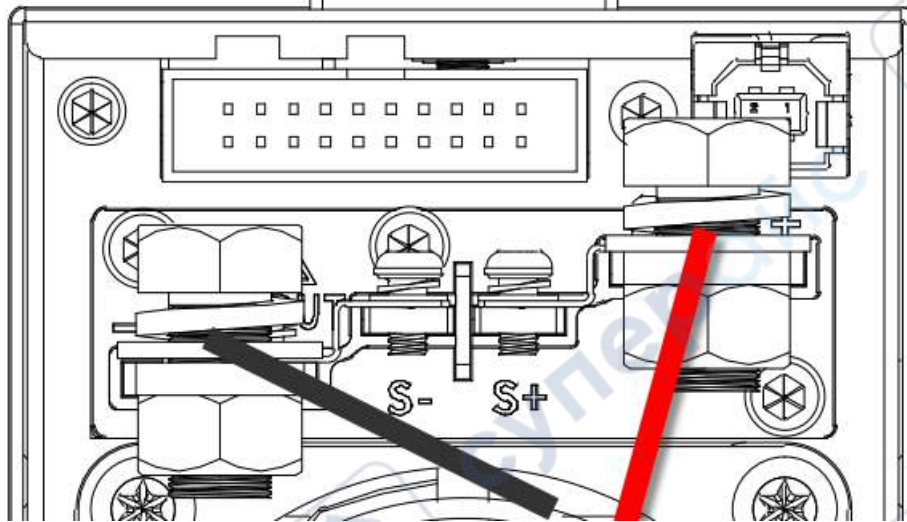
**Warning**

The power switch must be turned off before installing wiring at the power output terminal. The plastic protective shell must be installed before turning on the power supply.

Otherwise, there may be a risk of electric shock.

The single-module model also has a front output port that can output a maximum current of 10 A.

**Warning**

The front and rear outputs cannot be used at the same time. When the front output is connected with the load, the rear port should not be connected with the load.

User Interface

According to different output channels, the SPS5000X series has different user interfaces.

Type I /Type II/Type III

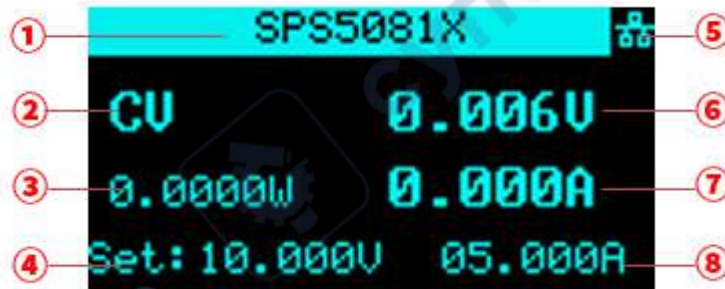

Type IV

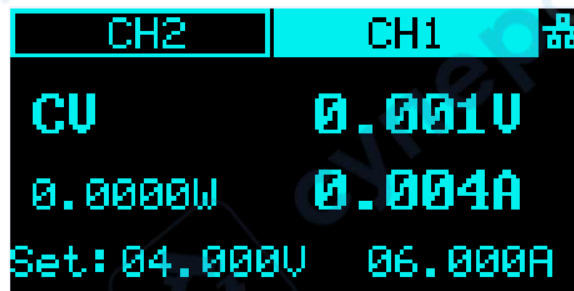

Type V:

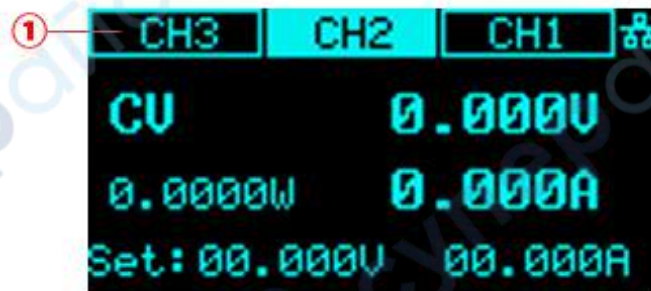

- ① Type I/Type II/Type III are single-channel models. The status bar here displays the machine model information. If it is multi-channel, the status of each channel is displayed here.

Type IV is a dual-channel model: Two channels CH1 and CH2 are displayed.

Type V is a three-channel model: Three channels of CH1, CH2, and CH3 are displayed.



- ② Display the current status of the power supplies. The symbol display and meaning of the power supply are as follows:

Symbol	Representation
CV	CV mode
CC	CC mode
Alt	Critical mode
S	Series mode
P	Parallel mode
CV:EXT	External control mode
CC:EXT	External control mode

- ③ Output power value.

- ④ Voltage setting value, you can set the size of the output voltage value.

Method: Press the **Set** / **V/I** key to switch the cursor position, press the left and right direction keys to switch the cursor to the number of digits, turn the knob to increase or decrease the value, press the knob to confirm, and the setting is complete.

- ⑤ Display the status of LAN network port or peripheral USB access. When the network cable is connected or the U disk is inserted, this place is highlighted.  means that a U disk has been read, and  means that the LAN cable is connected.

- ⑥ Output voltage value, take the average voltage

- ⑦ Output current value, take the average value of current.

- ⑧ Current setting value, you can set the size of the output current value.

Method: Press the **Set** key to switch the cursor position, press the left and right direction keys to switch the cursor to the number of digits, turn the knob to increase or decrease the value, press the knob to confirm, and the setting is complete.

Basic Operation

This chapter will introduce the functions and operation methods of the control panel of SPS5000X in detail so that you can have a more comprehensive understanding of the SPS5000X for better work.

Before using the product, it is necessary to confirm that the product can work and output normally. Confirmation steps: Power Off → Normally connect the sense sheet and the output terminal is not wired → Install the shell, Power On and Restore Default → Set 5V 0.5A and output → Make sure the working mode is CV and the voltage readback value is between 4.075V and 5.025V → Power Off and Short circuit output → Install the shell and Power On → Make sure the working mode is CC and the current readback value is between 395mA and 605mA.

System Settings

View Version Information

Operation method: Press → 1.System → 1.Version on the panel to call up the system information interface.

The information that can be viewed on the interface includes: Boot times, vendor name, model, product specification, serial number, host version, and slave version.

System Upgrade

Please follow the steps below to upgrade the firmware:

- 1) Download the firmware upgrade package from the official website.
- 2) Copy the .ADS file in the upgrade package to the root directory of the U disk(FAT32).
- 3) Insert the USB flash disk into the USB port of the front panel.
- 4) Press Menu → 1.System → 4.Upgrade on the front panel, and select the upgrade file.
- 5) Press the button to confirm. The upgrade progress bar will pop up. After the upgrade is successful, it will restart. If it fails, a prompt box will pop up.

Any operation that interrupts the upgrade process may cause upgrade failure or even the

machine cannot be restarted. Do not remove the USB memory device or make any changes to the power supply while updating.

Restore Default

Operation method: After pressing **Menu** → **1.System** → **2.Default Setting** on the front panel, press the knob on the interface, turn the knob to select **Yes** and press the knob to confirm, and automatically return to the main interface after successful setting.

Beeper Setup

Operation method: After pressing **Menu** → **1.System** → **3.Key sound** on the front panel, press the knob on the interface, turn the knob to On, press the knob to confirm, and the buzzer setting is turned **on**. To set off, press the knob again to select **Off**, press the knob to confirm, and the buzzer setting is off.

Parallel/Series Operation

The content of this chapter requires an external analog interface cable, which is an option of this product. Users can purchase it on the official website according to their needs. For more option information, please click the official website (www.siglent.com).

The content of this section is divided into two parts: series and parallel between independent machines and series and parallel between multiple channels of the same machine.

Parallel or Series among multiple SPS5000X supplies

Two or three power supplies can be connected in series or parallel to extend the output capabilities.

Supported models

Mode	Rated voltage(V)	Rated current(A)
SPS5051X	50	10
SPS5041X	40	30
SPS5042X		60
SPS5043X		90
SPS5081X	80	15
SPS5082X		30
SPS5083X		45
SPS5161X	160	7.5
SPS5162X		15
SPS5163X		22.5

The following uses 2 SPS5081X as an example to realize the method of series and parallel connection. The two machines are arbitrarily named A and B, which can realize two connection combinations of series between AB and parallel between AB

(1) Series between AB

Before realizing serial output, it is necessary to set the mode of SPS and connect the output port and back-end analog interface.

Mode setting

Setting method: **Menu** → **1.System** → **5.M/S mode settings** to enter the setting interface, press the knob to display a cursor, turn the knob to select the configuration of the slave/slave mode, and press the knob to make the setting effective.

After SPS power supply A enters the menu 5. M/S mode settings interface according to the above setting method, select 4. Master/Series option, SPS power supply B enters the setting interface according to the above method, and select 6. Slave/series option.

Setting interface

```
1.Master
2.Master/Parallel1
3.Master/Parallel2
*4.Master/Series
5.Slave/Parallel
```

```
2.Master/Parallel1
3.Master/Parallel2
4.Master/Series
5.Slave/Parallel
*6.Slave/Series
```

After the setting is successful, A is the master, B is the slave, and the voltage and current buttons of B cannot be operated.



A main interface



B main interface

Output port connection

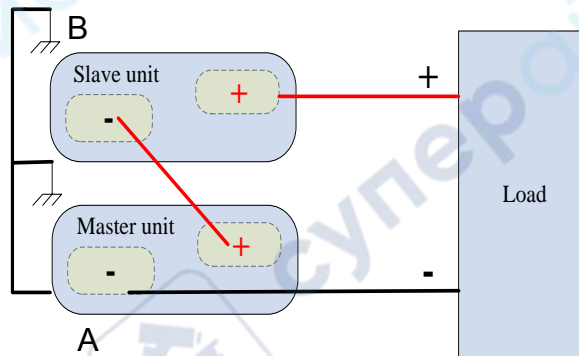

Analog port connection

Users can use the analog connection line option to realize the analog port connection between two power supplies. You can also make your own connection line according to the corresponding relationship of each port number to realize the connection control between the AB SPS power supply.

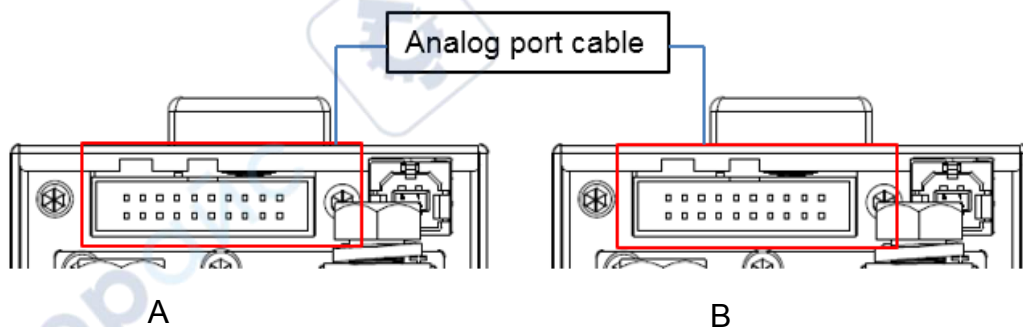



A:Master

B:Slave



In series, the output control of the entire series system is realized by the host A. The maximum output voltage that can be set is twice the rated voltage of the current model. The output voltage and current of the host A are set to be the output voltage and current of the series system.

(2) Parallel between AB

Mode setting

Setting method: → **1.System** → **5.M/S mode settings** to enter the setting interface, press the knob to display a cursor, turn the knob to select the configuration of the slave/slave mode, and press the knob to make the setting effective.

After power supply A enters the menu 5. M/S mode settings interface according to the above setting method, select 2.Master/ Parallel1 option, power supply B enters the setting interface according to the above method, and select 5. Slave/ Parallel option.

Setting interface

```
1.Master
#2.Master/Parallel1
3.Master/Parallel2
4.Master/Series
5.Slave/Parallel
```

A

```
1.Master
2.Master/Parallel1
3.Master/Parallel2
4.Master/Series
#5.Slave/Parallel
```

B

After the setting is successful, A is the master, B is the slave, and the voltage and current buttons of B cannot be operated.

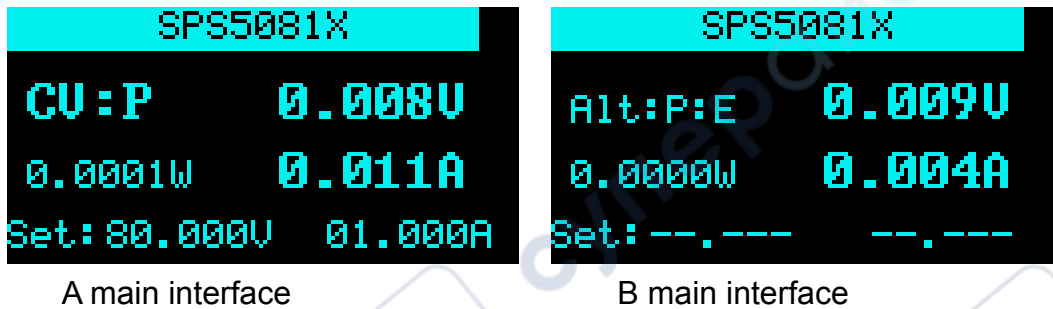

Output port connection

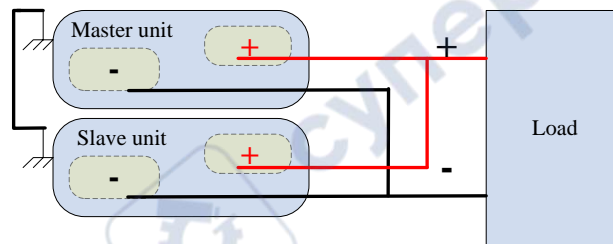

Analog port connection

The user can use the analog connection line option to realize the analog port connection between two power supplies. You can also make your own connection line according to the corresponding relationship diagram of each port number to realize the connection control between the AB power supply.

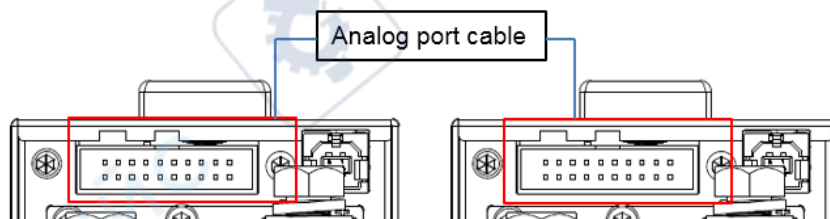

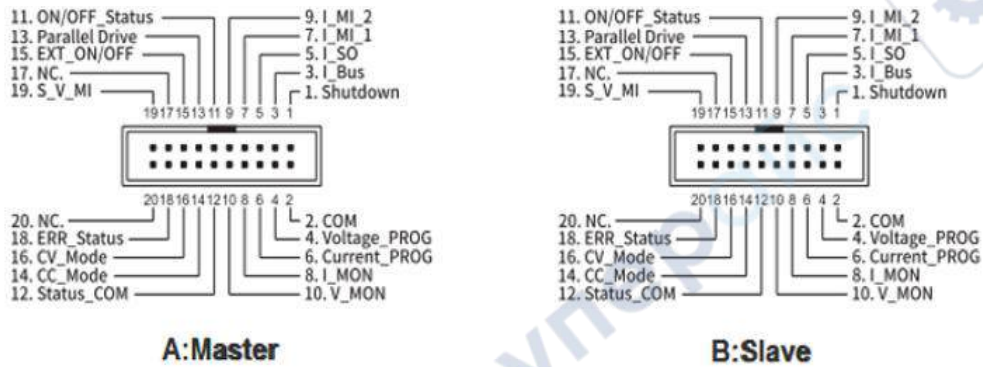

In parallel, host A realizes the output control of the entire parallel system. The maximum output current that can be set is twice the rated current of the current model. Host A sets the output voltage and current to the output voltage and current of the parallel system.

(3) ABC parallel

Three SPSs of the same model are arbitrarily named A, B and C.

Mode setting

Setting method: → **1.System** → **M/S mode settings** enter the setting interface, press the knob to display a cursor, turn the knob to select the configuration of the slave/slave mode, and press the knob to make the setting effective. When * appears in front of the option, it means the currently selected item.

After power supply A enters the menu 5. M/S mode settings interface according to the above setting method, select 3.Master/ Parallel2 option, power supply B enters the setting interface according to the above method, select 5. Slave/ Parallel option, power supply C and B have the same settings, also select 5. Slave/ Parallel option.

Setting interface

```

1.Master
2.Master/Parallel1
*3.Master/Parallel2
4.Master/Series
5.Slave/Parallel
    
```

A

```

2.Master/Parallel1
3.Master/Parallel2
4.Master/Series
*5.Slave/Parallel
6.Slave/Series
    
```

B and C

After the setting is successful, A is the master, B and C are the slaves, and the setting voltage and current buttons of B and C cannot be operated.

```

SPS5081X
CV:P 0.008V
0.0001W 0.011A
Set: 80.000V 01.000A
    
```

A main interface

```

SPS5081X
Alt:P:E 0.009V
0.0000W 0.004A
Set: --.--- --.---
    
```

B C main interface

Output port connection

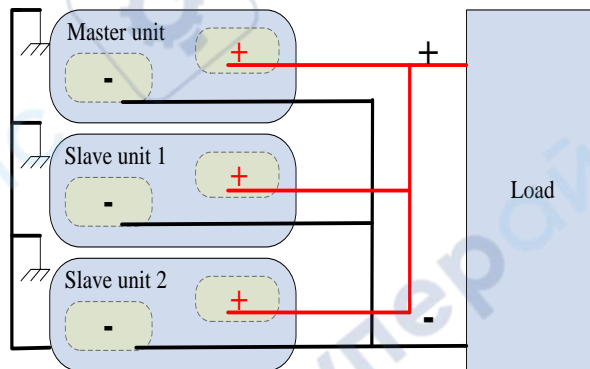

Analog port connection

User can use the analog connection line option to realize the analog port connection between the three power supplies. You can also make your own connection line according to the corresponding relationship diagram of each port number to realize the connection control between the three power supplies.

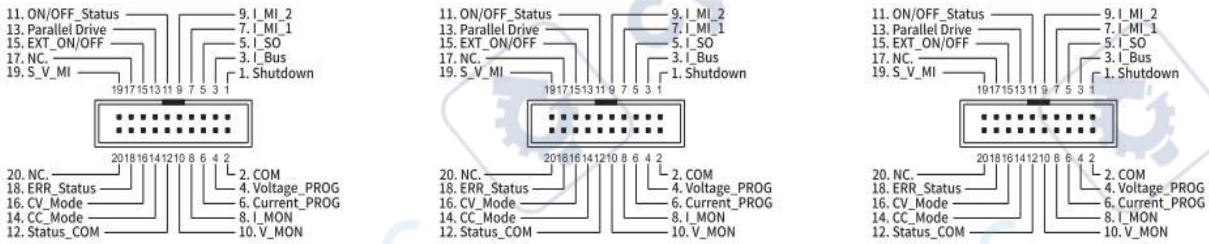
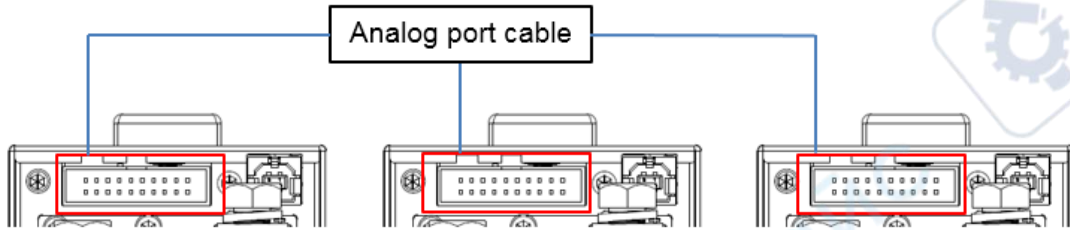

A: Master

B: Slave

C: Slave

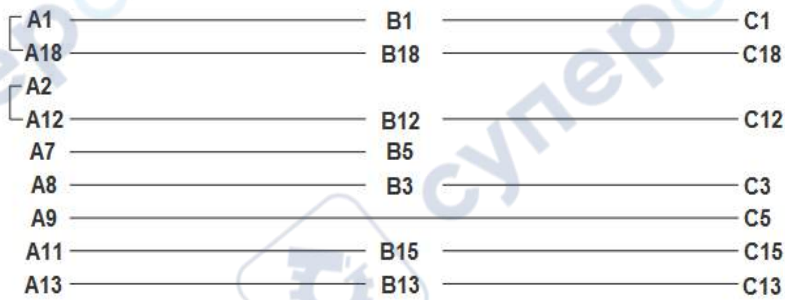

When three power supplies are output in parallel, host A realizes the output control of the entire parallel system. The maximum output current that can be set is three times the rated current of the current model. The output voltage and current of host A are set to the output voltage and current of the parallel system.

Parallel or Series among channels

Models with two or three output channels, support the combination series or parallel output between the channels

Supported models

Mode	Channels	Output combination	Voltage(V/CH)	Current(A/CH)
SPS5044X	2	CH1/CH2 series CH1/CH2 parallel	40	30
SPS5084X			80	15
SPS5164X			160	7.5
SPS5045X	3	CH1/CH2 series CH1/CH2 parallel CH1/CH2/CH3 parallel	40	30
SPS5085X			80	15
SPS5165X			160	7.5

(1) CH1/CH2 series

Before realizing serial output, it is necessary to set the mode of SPS and connect the output port and back-end analog interface.

Mode setting

Setting method: **Menu** → **1.System** → **5.M/S mode settings** to enter the setting interface, press the knob to display a cursor, turn the knob to select the configuration of the slave/slave mode, and press the knob to make the setting effective.

Set CH1 to SER according to the above setting method, and the state of CH2 will be automatically set according to the selection of CH1. After the setting is successful, CH1 is the master, CH2 is the slave, and the setting voltage and current buttons of CH2 cannot be operated.

Output port connection

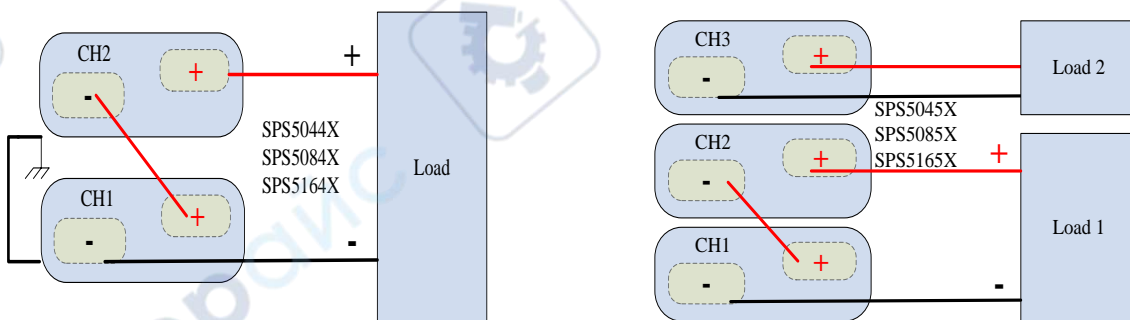

Analog port connection

User can use the analog connection line option to realize the analog port connection between the two channels. You can also make your own connection line according to the corresponding relationship of each port number to realize the connection control between the two channels.

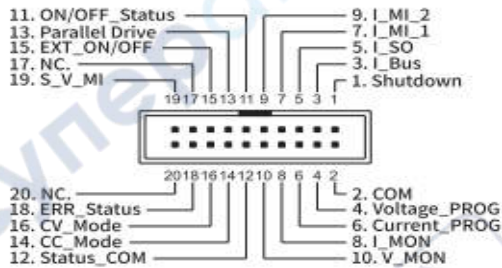
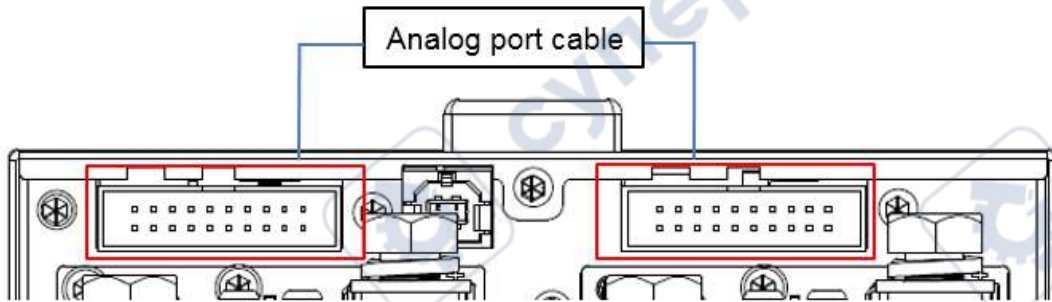

A:Master

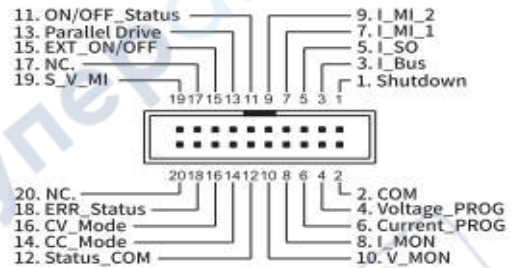

B:Slave



In series output, CH1 realizes the output control of the entire series system. The maximum output voltage that can be set is twice the rated voltage of the current model. The output voltage and current of CH1 are set to the output voltage and current of the series system.

(2) CH1/CH2 parallel

Before realizing serial output, it is necessary to set the mode of SPS and connect the output port and back-end analog interface.

Mode setting

Setting method: → **1.System** → **5.M/S mode settings** to enter the setting interface, press the knob to display a cursor, turn the knob to select the configuration of the slave/slave mode, and press the knob to make the setting effective.

Set CH1 to PAR1 according to the above setting method, and the state of CH2 will be automatically set according to the selection of CH1. After the setting is successful, CH1 is the master, CH2 is the slave, and the setting voltage and current buttons of CH2 cannot be operated.

Output port connection

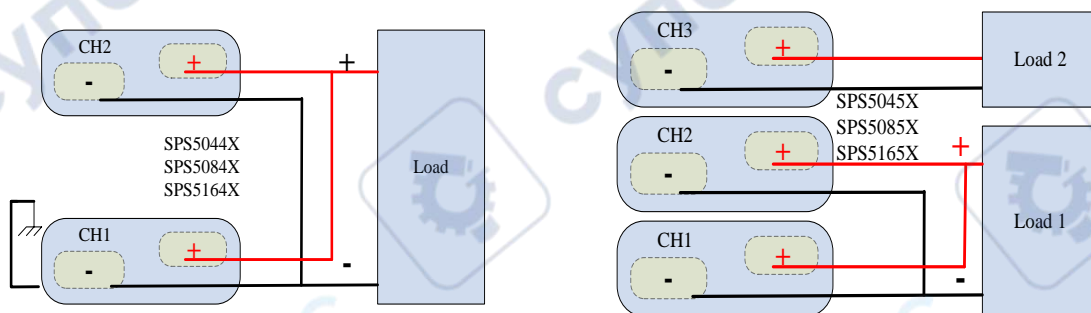

Analog port connection

User can use the analog connection line option to realize the analog port connection between the two channels. You can also make your own connection line according to the corresponding relationship of each port number to realize the connection control between the two channels.

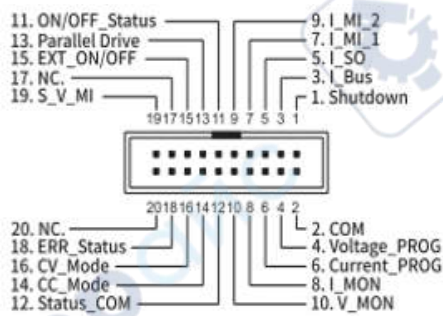
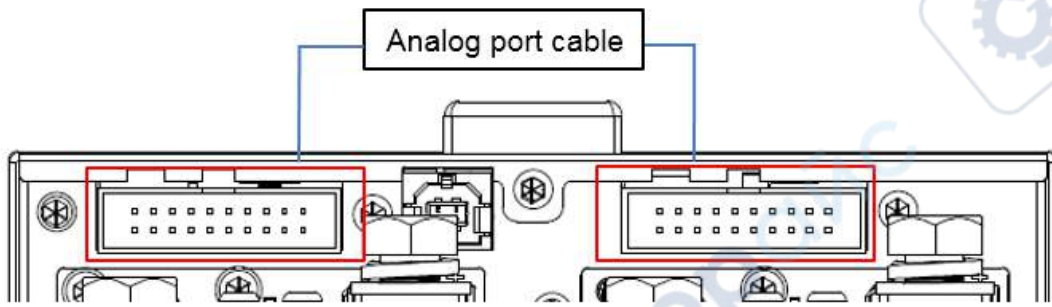

A:Master

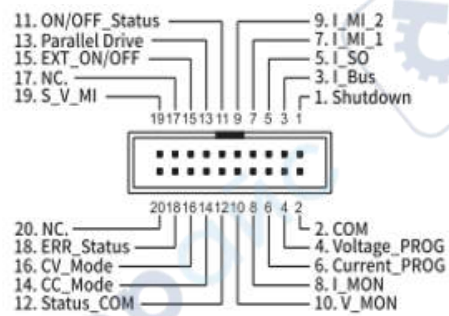

B:Slave



During parallel output, CH1 realizes the output control of the entire parallel system. The maximum output current that can be set is twice the rated current of the current model. The output voltage and current of CH1 are set to the output voltage and current of the parallel system.

(3) CH1/CH2/CH3 parallel

Before realizing parallel output, you need to set the mode of SPS and connect the output port and the back-end analog interface.

Mode setting

Setting method: → **1.System** → **5.M/S mode settings** to enter the setting interface, press the knob to display a cursor, turn the knob to select the configuration of the slave/slave mode, and press the knob to make the setting effective.

Set CH1 to PAR2 according to the above method, the state of CH2 and CH3 will be automatically selected according to the setting of CH1, at this time, CH1/CH2/CH3 are output in parallel.

Output port connection

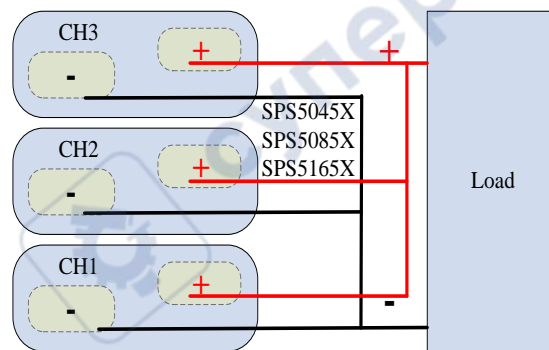

Analog port connection

User can use the analog connection line option to realize the analog port connection between the three channels. You can also make your own connection lines according to the corresponding relationship of each port number to achieve connection control between channels.

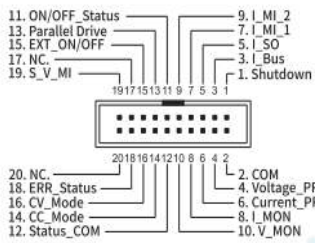
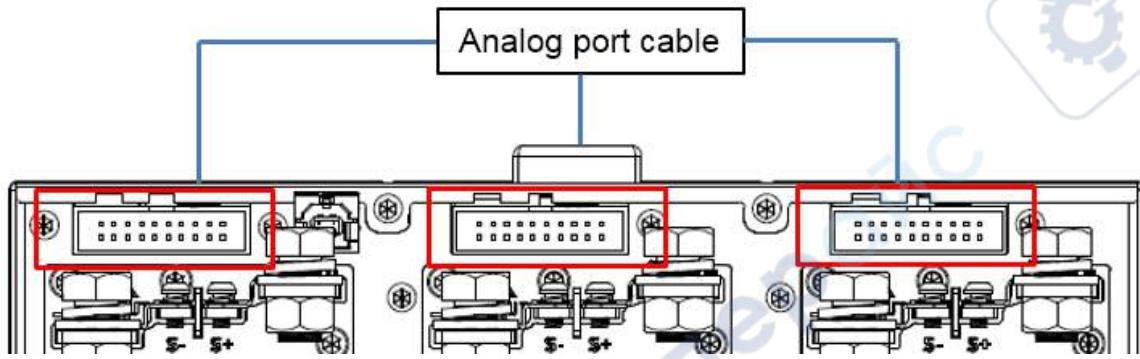

A:Master

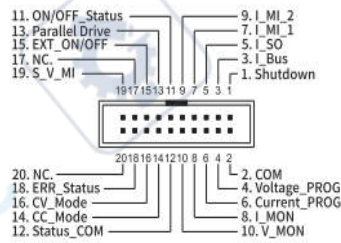

B:Slave

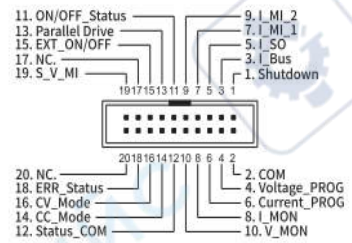

C:Slave

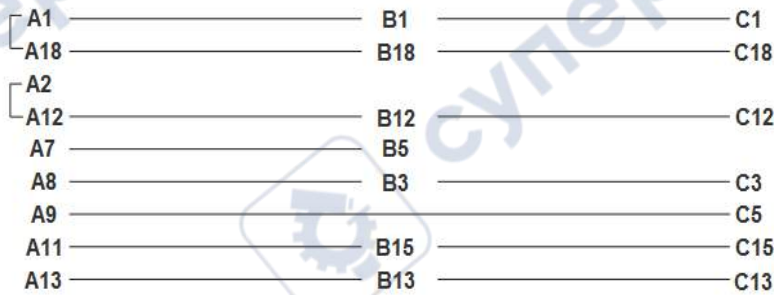

When the three channels are output in parallel, CH1 realizes the output control of the entire parallel system. The maximum output current that can be set is three times the rated current of the current model. The output voltage and current of CH1 is set to the output voltage and current of the parallel system.

Function Settings

Set List Function

1) Single-channel models

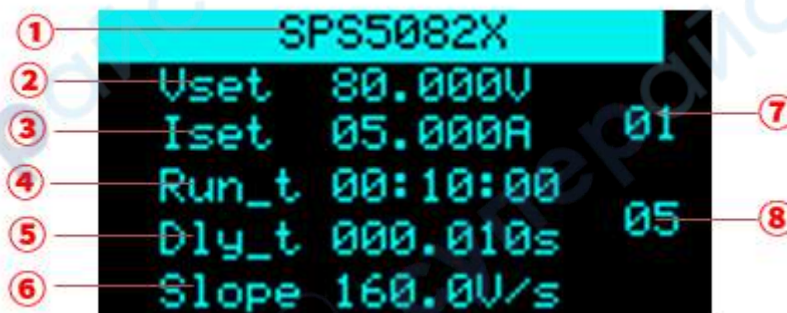

The following UI introduction is the display effect of the old version, and the introduction to the use of the list function of 3.1.1.8 and the latest version, which is followed by the content of this section.

Press the List key directly on the operation panel to enter the List setting interface, and press the List key again to exit the List mode:





① Display model, not editable.

② Set the output voltage level

Setting method: In the List setting interface, press the knob to display the cursor, press  key to move the cursor to the position, press  key to move the cursor to the digit to be changed, turn the knob to increase or decrease the value, and press the knob to enter the setting.

③ Set the output current level

Setting method: In the List setting interface, press the knob to display the cursor, press  key to move the cursor to the position, press  key to move the cursor to the digit to be changed, turn the knob to increase or decrease the value, and press the knob to enter the setting.

④ Single-step running time

Setting method: In the List setting interface, move the cursor to here, turn the knob to change the level, and press the knob to confirm the setting.

⑤ Output delay time

⑥ Slope level

When the power supply is set to CC mode priority, here is the current slope. When set to CV priority, this is the voltage slope.

Setting method: In the List setting interface, move the cursor to here, turn the knob to change the level, and press the knob to confirm the setting.

⑦ Number of List groups in the current setting interface, 01 means the first group

Setting method: In the List setting interface, press the key when the cursor is hidden to switch the current group number interface.

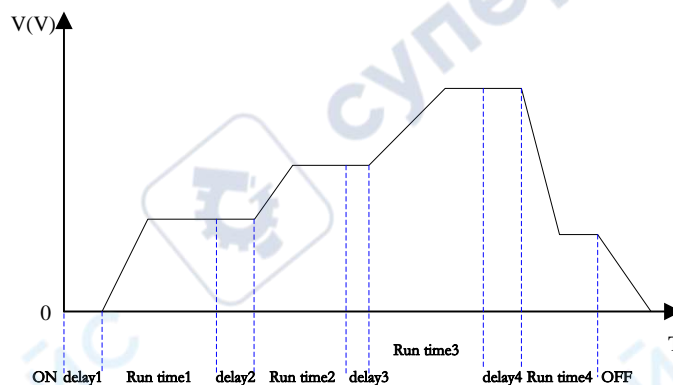

⑧ Total number of steps, the total number of steps output by List, 05 means there are 5 sets of data

Setting method: In the List setting interface, move the cursor to here, turn the knob to change the value, and press the knob to confirm.



List mode

2) Multi-channel model

To set the List output, first set the channel mode to List mode. Setting method: Press **Menu** → **Configure** → **10.Channel Mode** to enter the setting interface. When the cursor is hidden, press the left and right direction keys  to switch the channel to be set CH1/CH2/ CH3. **CH1** means that the CH1 channel is currently selected. Press the knob and then turn the knob to select . Press the knob. When it is displayed as **List**, the channel List mode is set successfully.

For other settings, refer to the single-channel output model method. During List output, press the knob to pause the time, and press the knob again to continue the output countdown.



3-channel List mode output example

3.1.1.8 and updated version list introduction

Press the List key on the front panel to enter the list main interface, as shown in the following figure



List main interface

- ① Channel display: press the left and right direction keys on the front panel to switch channels. For single channel models, the model information is displayed here.
- ② Displays the real-time voltage at the list status output.
- ③ Displays the real-time power output by the list.
- ④ Running time: displays the remaining time of the current steps. The time countdown is performed in the form of hour: minute: second when outputting.
- ⑤ Displays the real-time current at the output of the list.
- ⑥ Display of running steps. It is expressed in the form of current running steps / total steps.
- ⑦ Operation prompt. Press the knob in this interface to enter the list parameter configuration interface.

Enter the list parameter configuration interface, rotate the knob to select parameters. Press the knob at the point where the * sign points to set this parameter. After setting, press the knob again to take effect.

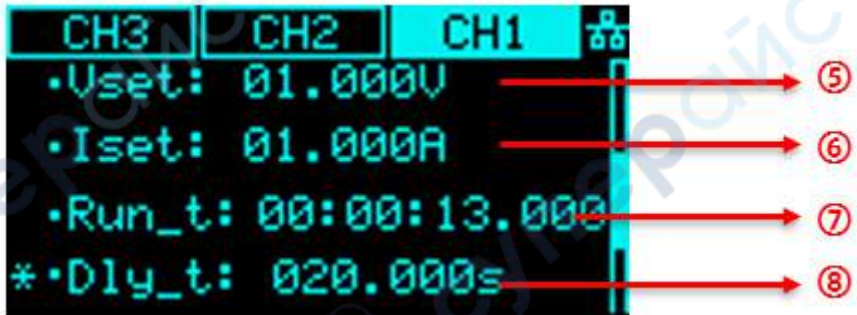
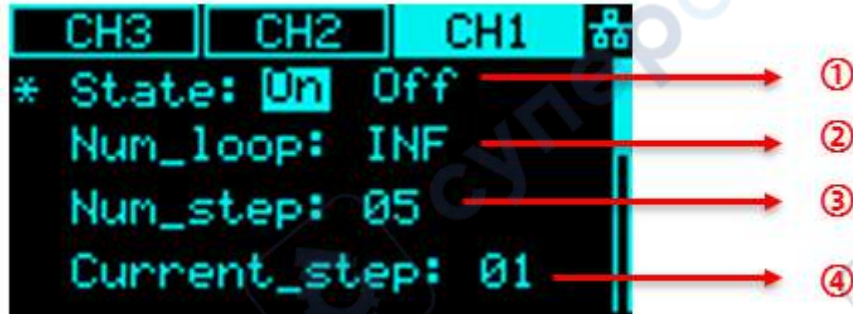

- ① List output enable status. It is used to realize the independent control of the list output of each channel by the multi-channel model. This setting is not available for single channel models.
- ② Number of cycles. Set the number of output cycles for the total number of steps, and INF is infinite cycle.
- ③ Total steps.
- ④ The number of steps of the current operation. 01 represents the first step.

- ⑤ Set the output voltage value for the current number of steps.
- ⑥ Set the output current value for the current number of steps.
- ⑦ The running time is expressed in the form of hour: minute: second.
- ⑧ Set the output delay time of the current number of steps.
- ⑨ The output priority mode of the current number of steps is fast priority by default.
When Slew is selected, ⑩ rising slope and ⑪ falling slope can be set.

Set OCP/OVP

Setting method: **Menu** → **Configure** → **1.Protect** , enter the setting interface. After pressing the knob, press the up and down direction keys to move the cursor, select the knob to change the value, and press the knob to confirm the setting takes effect.

OCP has added the switch OCP function option key. When it is displayed as **On** , it means that the OCP function is on. Setting method: Press the knob on the setting interface, move the cursor to the shadow overlay On/Off, turn the knob to select On or Off, press the knob to confirm and the setting will take effect. When the display is **Off** , it means that the OCP function is turned off and the power supply will not trigger over-current protection.

Set Bleeder Resistor Control

Setting method: **Menu** → **Configure** → **2.Shunt** , enter the setting interface. Press the knob in the interface, turn the knob to switch the Off/On options, press the knob to confirm and the setting takes effect.

Set CC/CV Priority

The SPS5000X operation mode can be set to select CC high-speed priority, CC slope priority, CV high-speed priority, and CV slope priority. High-speed priority makes the voltage and current change at the fastest rate, and slope priority makes the power supply change in voltage and current at a specified slope.

Setting method: **Menu** → **3.Operating Mode** to proceed to the next submenu interface.



Press the knob to enter the **1.Mode** interface, and you can select the CC/CV mode. After pressing the knob, turn the knob to switch between CC or CV. Press the knob to confirm and the setting takes effect. When **CC** is displayed, it means that it is currently in CC mode. Press **Esc** to return to the previous menu.

Turn the knob to **2.Priority mode** and press the knob to enter, you can set the mode as high-speed priority or slope priority. The setting method is the same as above, and the setting takes effect after pressing the knob to confirm. When High Speed is displayed, it means that the current mode is high-speed priority mode, and the slope cannot be edited in this mode. Press **Esc** to return to the previous menu.

When set to slope priority mode, press the knob to enter the **3.Slew value** interface, you can set the voltage rise/fall slope or current rise/fall slope.

Set Output On/Off Delay Time

The SPS5000X can be set to turn on the output delay function and turn off the output delay function.

Setting method: **Menu** → **2.Configure** → **4.Output delay** to enter the setting interface. In the interface, press the knob to display a cursor, press  to switch the setting of on delay or off delay, press  key to switch the number of digits, and turn the knob to change the value. After the setting is completed, you need to press the knob to confirm.

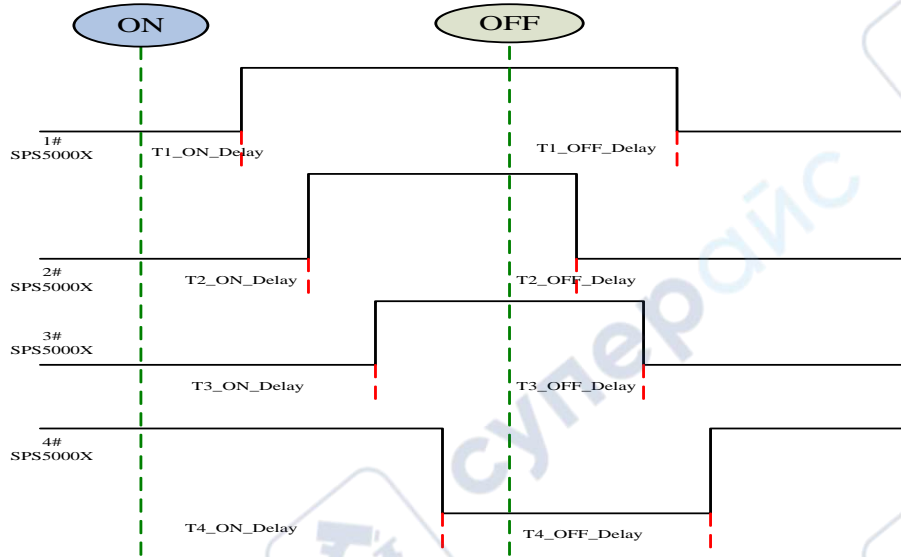

Set Internal Resistance

Setting method: → **2.Configure** → **5.Output resistance** Enter the setting interface. Press the knob to display the cursor. Press the key  to switch the digit where the cursor is located. Turn the knob to increase or decrease the value. After the setting is completed, you need to press the knob to confirm it to take effect.

Different types of power supplies can be set with different internal resistance values, see the previous chapter 6.5 for details.

Set Measurement Accuracy

The SPS5000X has three measurement accuracy modes to choose from: Low, Mid and High. When Low is selected, the measurement rate is the fastest but has less accuracy. High is the slowest measurement, but more accuracy. High is selected by default.

Setting method: → **2.Configure** → **6.Measure average** to enter the setting interface. Press the knob in the interface, turn the knob to switch the cursor, press the knob to confirm and the setting takes effect.

External Analog Control

Four working modes of voltage control voltage, voltage control current, resistance control voltage, and resistance control current can be realized through the ports on the rear panel. In the external voltage control mode, an adjustable voltage of 0-10 V is connected to the input terminal to simulate the output from 0 to full-scale, to adjust the value of the voltage and current output by the power supply (10 V corresponds to the voltage or current value of the full-scale of the power supply).

◆ External voltage control voltage output

Setting method: **Menu** → **2.Configure** → **7.Voltage control**, press the knob or the **Set** button to enter the setting interface, then press the knob or the **Set** button to enter the selection, and press the knob or turn the knob to select **Ext_V**, and then press the knob or the **Set** button to confirm.

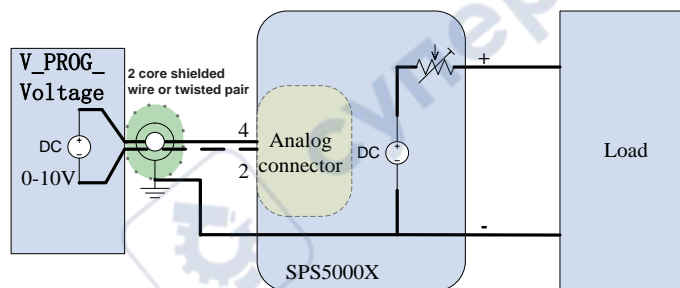

External voltage control voltage output

◆ External resistance control voltage output:

The operation method is the same as (external voltage control voltage output), select and confirm **Ext_R**

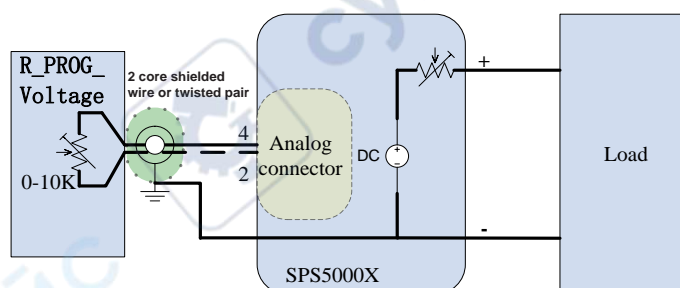

External resistance control voltage output

◆ External voltage control current output:

Setting method: **Menu** → **2.Configure** → **8.Current control**, press the knob or the **Set** button to enter the setting interface, then press the knob or the **Set** button to enter the selection, and then press the knob or the **Set** button to select **Ext_V**, and then press the knob or the **Set** button to confirm.

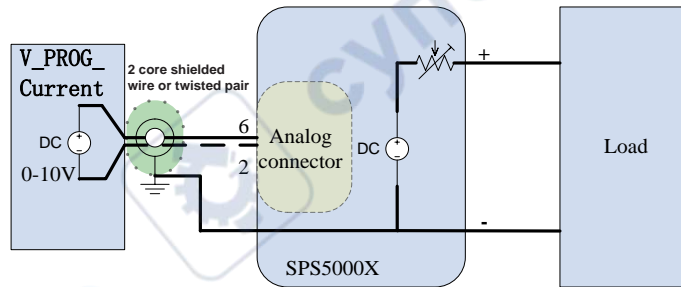

External voltage control current output

◆ External resistance control current output:

The operation method is the same as (external voltage control current output), select and confirm **Ext_R**.

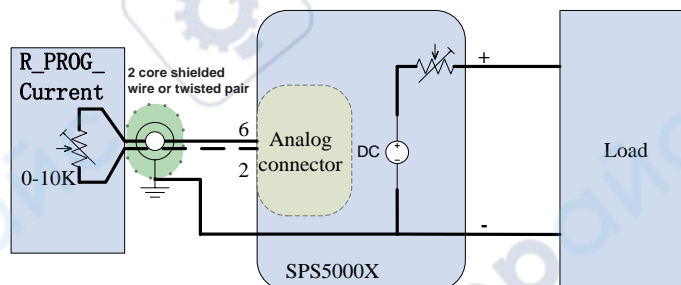

External resistance control current output

External Control Output On/Off

When set to ON, the Output button on the front panel is invalid. The output is controlled by the rear analog interface pin15 low-level effective control, and the reference ground is pin 2 (COM).

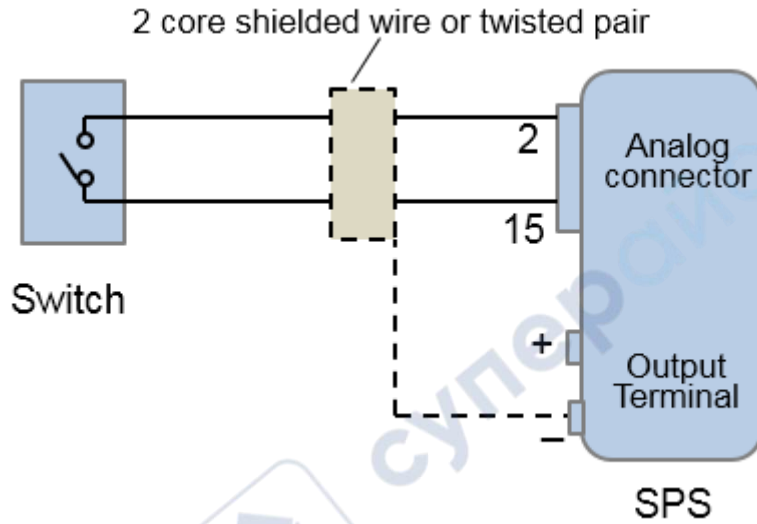

External control output on / off

When using the switch remotely, please use the switch relay to extend the circuit

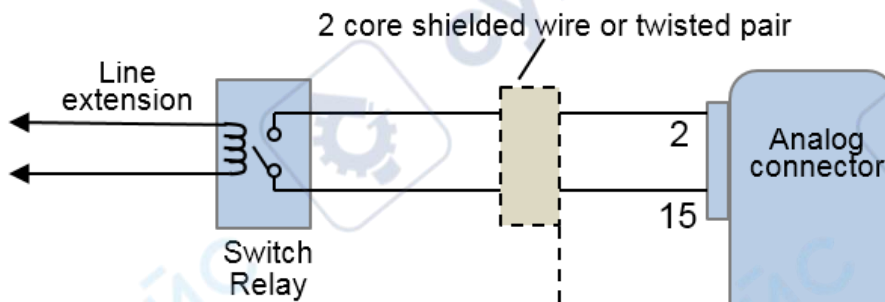

Use relay switch



Note

If you use a switch to control multiple instruments, make sure that each instrument is independent and use a relay to complete the operation.

Setting method: → → enter the setting interface. After pressing the knob, turn the knob to switch On/Off. Press the knob to confirm and the setting takes effect.

Multi-channel Settings

For models with multiple output channels, the channel mode can be set.

Setting method: **Menu** → **2.Configure** → **10. Channel Mode** to enter the setting interface. In the interface, press the key to switch the channel selection. Press the knob and then turn the knob to switch the channel selection mode. Press the knob to confirm and the setting takes effect.

Off: The channel is closed. When the output is turned on, the channel in the Off state has no voltage or current output.

Normal: The channel is in the normal state. When the output is turned on, each channel outputs according to the set voltage and current.

List: List mode. After the channel is set to List mode, when the output is turned on, the channel outputs according to the voltage and current values set by the List.

The figure shows that the CH2 and CH3 channels are Off.



Analog Interface

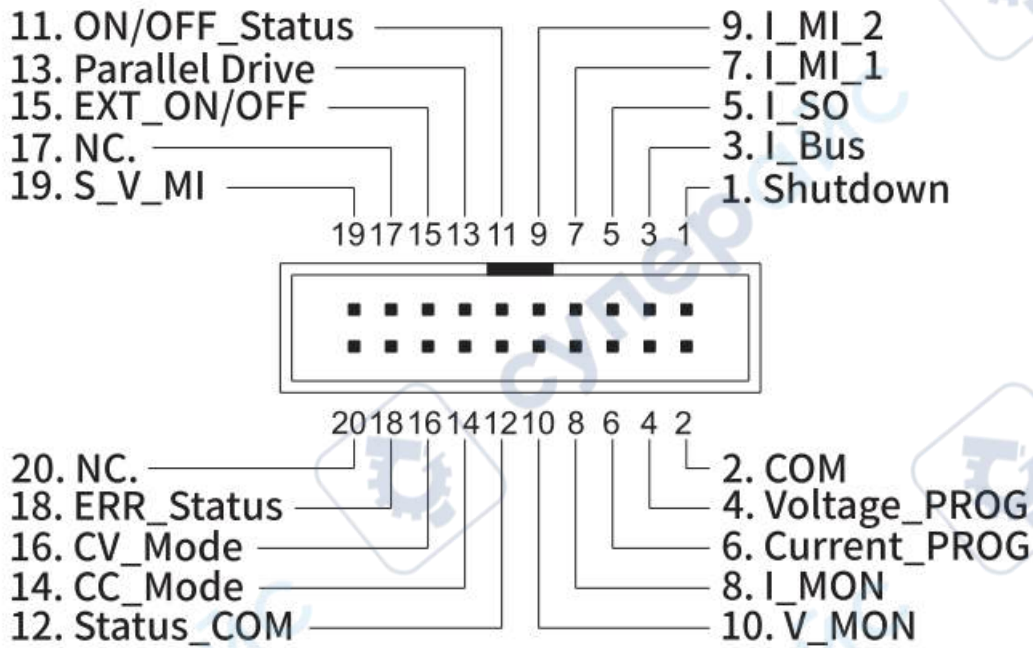

Pin Number	Description
01	The shutdown signal will turn off the output when a low TTL signal is applied. The shutdown signal is pulled up to 5V with a 10kΩ pull-up resistor.
03	Used when operating 2 or more units in parallel.
05	Current sum output signal when used in parallel mode.
07	Master unit current sum input signal from the first slave CURRENT SUM OUTPUT. Used in parallel mode only.
09	Master unit current sum input signal from the second slave CURRENT SUM OUTPUT. Used in parallel mode only.
11	Turns on when the output has been turned on. (photo coupled open collector output)
13	Parallel control signal during master-slave parallel operation.
15	Turns the output on/off when (default setting) a low TTL signal is applied. Internally, the circuit is pulled up to +5 V with 10 kΩ

resistance.

- 19** Series slave input during master-slave series operation.
(40 V/80 V/160 V models only)
- 02** Control signal common. Connected to the sense terminal when remote sense is used.
Connected to the negative output terminal when remote sense is not used.
- 04** External voltage control of the voltage output.
A voltage of 0~10 V is used to control the full-scale voltage output (0%~100%) of the instrument.
External resistance control of the voltage output.
A resistance of 0 k Ω ~ 10 k Ω is used to control the full-scale voltage output (0%~100%) of the instrument.
- 04,02** When connecting the external voltage source to the MIL connectors, use shielded or twisted paired wiring.
- 06** External voltage control of the current output.
A voltage of 0~10V is used to control the full-scale current output (0%~100%) of the instrument
External resistance control of the current output.
A resistance of 0k Ω ~ 10k Ω is used to control the full-scale current output (0%~100%) of the instrument.
- 08** Current Monitor Output. Outputs the full-scale current (0~100%) as a voltage (0V~10V).
- 10** Voltage Monitor Output. Outputs the full-scale voltage (0~100%) as a voltage (0V~10V).
- 12** Common for status signals 14, 16, and 18.
- 14** Turns on when CC mode is active. (photo coupled open collector output)
- 16** Turns on when CV mode is active. (photo coupled open collector output)

- 18** Turns on when any of the protection modes are tripped (OVP, OCP) or if a shutdown signal is received. (photo coupled open collector output)

Save/Recall

SPS supports storing the current settings to an internal or external U disk, and the user can call the saved file to restore the settings.

Setting method: In the main interface, press the **Recall** button on the front panel to enter the store recall interface, press the **Recall** button again to switch between the save mode and the recall mode

If stored in the internal (Internal), 8 groups of data can be stored, with * indicating that there are data items currently stored.

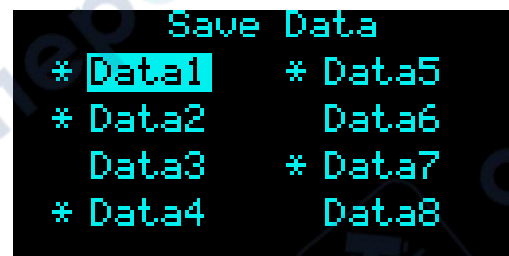
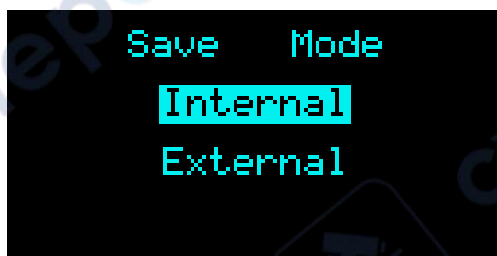

Select the stored data in the Recall mode to perform the setting recovery operation.

If you choose the External option, the data will be stored in the external USB flash drive. In the Recall mode, enter the External and browse the USB flash drive files to recall.

Press the **Recall** key in the List mode to store and recall List data. For the method to enter the List, refer to the chapter 9.2.1 List Function.

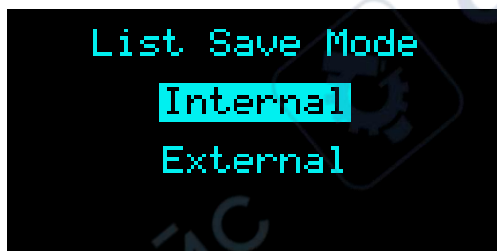

Communication interface settings

◆ USB

USB cannot be edited, only viewing operations can be performed.

Operation method: **Menu** → **3.Communication** → **1.USB**. After entering the interface, you can view the resource information of the USB device.



◆ GPIB

Setting method: **Menu** → **3. Communication** → **2. GPIB** enters the setting interface, press the knob to display a cursor, turn the knob to change the value, and press the knob to make the setting effective.

◆ LAN

SPS5000X supports DHCP function, users can set to obtain IP automatically or set IP manually. You can set the DHCP switch, IP address, gateway address, and subnet mask address.

Setting method: **Menu** → **3. Communication** → **3.LAN** to enter the LAN setting interface. Press the knob to display the cursor position, press  to move the cursor position up and down. When **On Off** is displayed, it means that the selection is On, turn the knob to switch On/Off, and press the knob to confirm the effect. When **On Off** is displayed, it means that DHCP is set to On, and the IP is automatically obtained at this time.

If you want to set the IP manually, first set DHCP to Off according to the above method. After pressing the knob, press the  key to move the cursor up and down, press the  key to move the cursor left and right, turn the knob to change the value, and press the knob to confirm the setting takes effect.

Remote Control

The SPS5000X supports communication with a computer via USB, LAN, and GPIB-USB interfaces using a SCPI (Standard Commands for Programmable Instruments) compliant command set.

This chapter will introduce how to build a programming environment and explain the SCPI commands supported by the SPS5000X.

Way to Control

Using NI-VISA

Users can realize remote control of the instrument by using NI-VISA of NI (National Instrument Corporation). Regarding NI-VISA, there is a complete and real-time version (Run-Time Engine version). The complete version includes NI device drivers and a tool called NI MAX. NI MAX is a user interface used to control the device. The real-time version is much smaller than the full version, and it only includes NI device drivers.

After installing NI-VISA, use a USB cable to connect the SPS5000X (via the USB Device interface on the rear panel) to the computer, or use a network cable to connect the SPS5000X (via the LAN interface on the rear panel) to the local area network where the computer is located.

Based on NI-VISA, users can remotely control SPS5000X in two ways, one is through web service; the other is custom programming combined with SCPI commands. For more information, please refer to the programming examples.

Using Sockets

Users can also use Sockets to communicate with SPS5000X based on the TCP/IP protocol through the network port. Socket communication is a basic communication technology of computer networks, which allows applications to communicate through network hardware

and standard network protocol mechanisms built into the operating system. This method requires two-way communication between the instrument and the computer network through an IP address and a fixed port number.

The port of SPS5000X for Socket communication is 5025.

After connecting the SPS5000X (via the LAN interface on the rear panel) to the local area network where the computer is located with a network cable, the user can combine SCPI commands for custom programming to realize remote control of the SPS5000X. For more information, please refer to the programming examples.

Grammatical Conventions

SCPI commands are a tree-like hierarchical structure, including multiple subsystems. Each subsystem is composed of a root keyword and one or several hierarchical keywords. Command keywords are separated by colons ':', keywords are followed by optional parameter settings, commands and parameters are separated by 'spaces', for multiple parameters, parameters are separated by commas ','. A question mark '?' is added after the command line, which means to query this function.

Most SCPI commands are a mixture of upper and lower case letters. Capital letters indicate the abbreviations of commands, namely short commands. If you want better program readability, you can use long commands. E.g:

```
[[:SOURce]:VOLTage[:SET]? CH1
```

Among them, the keyword VOLTage. You can enter VOLT or VOLTage, and combine upper and lower case letters at will. Therefore, VoITaGe, volt, and Volt are all acceptable. Other formats (such as VOL and VOLTAG) will produce errors.

- Braces ({ }) enclose the parameter selection. The braces are not sent with the command string.
- The vertical line (|) divides the parameter selection.
- Angle brackets (< >) indicate that a value must be assigned to the parameter inside the

bracket. The angle brackets are not sent with the command string.

- Optional parameters are enclosed in square brackets ([]). If you do not specify a value for the optional parameter, the instrument will use the default value. For example, the [:SET] in the above command can be omitted (for example: 'VOLT? CH1'), and the command will operate on the current channel. The square brackets are not sent with the command string.

Command Summary

- 1) IEEE Common Command Subsystem.
- 2) Measure Command Subsystem.
- 3) Configure Configuration Command Subsystem.
- 4) List Configuration Command Subsystem.
- 5) System Configuration Command Subsystem.

Command Description

IEEE Common Command Subsystem

*IDN?

Command format: *IDN?

Description: Get device information string (return string content includes: manufacturer, device model, device serial port number, software version number)

E.g: *IDN?

Response: Siglent Technologies,SPS5082X,SPS5X2006005,3.1.1.5\n

*RST

Command format: *RST

Description: Restore the state of the device to the initial state.

E.g: *RST

*CLS

Command format: *CLS

Description: Clear the values of all event registers and clear the error list at the same time

E.g: *CLS

*ESE

Command format: *ESE <number>

Description: Set the enable value of the standard event status register

E.g: *ESE 16

*ESE?

Command format: *ESE?

Description: Query the enable value of the standard event status register.

E.g: *ESE?

Response: 64

*ESR?

Command format: *ESR?

Description: Query and clear the event value of the standard event status register.

E.g: *ESR?

Response: 0

*OPC

Command format: *OPC

Description: Operation complete.

E.g: *OPC

OPC?*Command format:** *OPC?**Description:** Query whether the current operation is complete.**E.g:** *OPC?**Response:** 1***SRE****Command format:** *SRE<number>**Description:** Set the enable value of the status byte register**E.g:** *SRE 24***SRE?****Command format:** *SRE?**Description:** Query the enable value of the status byte register**E.g:** *SRE?**Response:** 24***STB?****Command format:** *STB?**Description:** Query the event value of the status byte register**E.g:** *STB?**Response:** 72***TST?****Command format:** *TST?**Description:** Query the result of instrument self-test**E.g:** *TST?**Response:** 0

***WAI**

Command format: *WAI

Description: Wait for all outstanding operations to complete before executing any other commands

E.g.: *WAI

Measure Command Subsystem**Set voltage value**

Command format: [:SOURce]:VOLTage[:SET] <channel>,{<value> | MINimum | MAXimum | DEFAULT}

Channel={CH1,CH2,CH3}

Description: Set the voltage value of the selected channel

E.g.: :SOURce:VOLTage:SET CH1,3

Description: Set the CH1 channel voltage value to 3V

Command format: [:SOURce]:VOLTage[:SET]? <channel>

Description: Get the set voltage value of the selected channel

E.g.: :SOURce:VOLTage:SET? CH1

Response: 3.000000\n

Obtain the measured voltage value

Command format: MEASure:VOLTage? <channel>

Description: Get the voltage measurement value of the selected channel

E.g.: MEASure:VOLTage? CH1

Response: 2.991442\n

Set current value

Command format: [:SOURce]:CURRent[:SET] <channel>,{<value> | MINimum | MAXimum | DEFAULT}

Description: Set the current value of the selected channel

E.g.: :SOURce:CURRent:SET CH1,2

Description: Set the CH1 channel current value to 3V

Command format: [:SOURce]:CURRent[:SET]? <channel>

Description: Get the set current value of the selected channel

E.g: :SOURce:CURRent:SET? CH1

Response: 2.000000\n

Obtain the measured current value

Command format: MEASure:CURRent? <channel>

Description: Get the current measurement value of the selected channel

E.g: MEASure:CURRent? CH1

Response:1.999407\n

Get power measurement

Command format: MEASure:POWER? <channel>

Description: Get the electrical power measurement value of the selected channel

E.g: MEASure:POWER? CH1

Response:19.959515\n

Get the running status of the channel

Command format: MEASure[:RUN]:MODE? <channel>

Description: Get the running status of the selected channel

E.g: MEASure:RUN:MODE? CH1

Response: CV\n

Configure Configuration Command Subsystem

Set OVP value

Command format: [:SOURce]:OVP <channel>,{<value> | MINimum | MAXimum | DEFault}

Description: Set the overvoltage value of the selected channel

E.g: :SOURce:OVP CH1,8

Description: Set the OVP value of CH1 channel to 8V

Command format: [:SOURce]:OVP? <channel>

Description: Get the overvoltage value of the selected channel

E.g: :SOURce:OVP? CH1

Response: 15.000000\n

Set OCP value

Command format: [:SOURce]:OCP <channel>,{<value> | MINimum | MAXimum | DEFault}

Description: Set the overcurrent value of the selected channel

E.g: :SOURce:OCP CH1,8

Description: Set the OCP value of CH1 to 8A

Command format: [:SOURce]:OCP? <channel>

Description: Get the overcurrent value of the selected channel

E.g: :SOURce:OCP? CH1

Response: 8.000000\n

Set OCP switch state

Command format: SYStem:OCP:STATe <channel>,{ON | OFF | 0 | 1}

Description: Set the ocp switch state of the selected channel

E.g: SYStem:OCP:STATe CH1, 1

Description: Set to open OCP function

Command format: SYStem:OCP:STATe? <channel>

Description: Get the ocp switch status of the selected channel

E.g: SYStem:OCP:STATe? CH1

Response: 1\n

Set the voltage rise slope

Command format: [:SOURce]:VOLTage:RISE:SLOPe <channel>,{<value> | MINimum | MAXimum | DEFault}

Description: Set the voltage rise slope value of the selected channel

E.g: :SOURce:VOLTage:RISE:SLOPe CH1,8

Description: Set the voltage rising slope of CH1 channel to 8V/s

Command format: [:SOURce]:VOLTage:RISE:SLOPe? <channel>

Description: Get the voltage rise slope value of the selected channel

E.g: :SOURce:VOLTage:RISE:SLOPe? CH1

Response: 23.000000\n

Set the voltage drop slope

Command format: [:SOURce]:VOLTage:FALL:SLOPe <channel>,{<value> | MINimum | MAXimum | DEFault}

Description: Set the voltage drop slope value of the selected channel

E.g: :SOURce:VOLTage:FALL:SLOPe CH1,8

Description: Set the voltage drop slope of CH1 channel to 8V/s

Command format: [:SOURce]:VOLTage:FALL:SLOPe? <channel>

Description: Get the voltage drop slope value of the selected channel

E.g: :SOURce:VOLTage:FALL:SLOPe? CH1

Response: 10.000000\n

Set current rising slope

Command format: [:SOURce]:CURRent:RISE:SLOPe <channel>,{<value> | MINimum | MAXimum | DEFault}

Description: sSet the current rising slope value of the selected channel

E.g: :SOURce:CURRent:RISE:SLOPe CH1,8

Description: Set the current rising slope of CH1 channel to 8A/s

Command format: [:SOURce]:CURRent:RISE:SLOPe? <channel>

Description: Get the current rising slope value of the selected channel

E.g: :SOURce:CURRent:RISE:SLOPe? CH1

Response: 8.000000\n

Set current falling slope

Command format: [:SOURce]:CURRent:FALL:SLOPe <channel>,{<value> | MINimum | MAXimum | DEFault}

Description: Set the current falling slope value of the selected channel

E.g: :SOURce:CURRent:FALL:SLOPe CH1,10

Description: Set the current falling slope of CH1 channel to 10A/s

Command format: [:SOURce]:CURRent:FALL:SLOPe? <channel>

Description: Get the current falling slope value of the selected channel

E.g: :SOURce:CURRent:FALL:SLOPe? CH1

Response: 13.000000\n

Set the voltage response change mode

Command format: [:SOURce]:VOLTage[:RESPonse]:MODE <channel>,{FAST| SLOPE}

Description: Set the voltage response change mode of the selected channel (FAST / SLOPE)

E.g: :SOURce:VOLTage:RESPonse:MODE CH1,FAST

Description: Set the voltage response of CH1 channel to FAST (fast priority) (set to CV mode available)

Command format: [:SOURce]:VOLTage[:RESPonse]:MODE? <channel>

Description: Get the voltage response change mode of the selected channel

E.g.: :SOURce:VOLTage:RESPonse:MODE? CH1

Response: Slope priority\n

Set current response change mode

Command format: [:SOURce]:CURRent [:RESPonse]:MODE <channel>,{FAST|SLOPE}

Description: Set the current response change mode of the selected channel (FAST / SLOPE)

E.g.: :SOURce:CURRent:RESPonse:MODE CH1,FAST

Description: Set the current response of CH1 channel to FAST (fast priority) (available when set to CC mode)

Command format: [:SOURce]:CURRent [:RESPonse]:MODE? <channel>

Description: Get the current response change mode of the selected channel

E.g.: :SOURce:CURRent:RESPonse:MODE? CH1

Response: Fast priority\n

Set voltage control mode

Command format: [:SOURce]:CTRL:VOLTage:MODE <channel>,{LOCAL|EXT_V|EXT_R|EXT_R_MAX}

Description: Set the voltage control mode of the selected channel (LOCAL|EXT_V|EXT_R|EXT_R_MAX)

E.g.: :SOURce:CTRL:VOLTage:MODE CH1,LOCAL

Description: Set the CH1 channel voltage control mode to LOCAL mode

Command format: [:SOURce]:CTRL:VOLTage:MODE? <channel>

Description: Get the voltage control mode of the selected channel

E.g.: :SOURce:CTRL:VOLTage:MODE? CH1

Response: LOCAL\n

Set current control mode

Command format: [:SOURce]:CTRL:CURRage:MODE <channel>,{LOCAL|EXT_V|EXT_R|EXT_R_MAX}

Description: Set the current control mode of the selected channel (LOCAL| EXT_V | EXT_R | EXT_R_MAX)

E.g: :SOURce:CTRL:CURRage:MODE CH1,LOCAL

Description: Set CH1 channel current control mode to LOCAL mode

Command format: [:SOURce]:CTRL:CURRage:MODE? <channel>

Description: Get the current control mode of the selected channel

E.g: :SOURce:CTRL:CURRage:MODE? CH1

Response: LOCAL\n

Set the bleeder circuit mode

Command format: [:SOURce]:CTRL:LOAD:MODE <channel>,{ ON | OFF }

Description: Set the bleeder circuit mode of the selected channel (ON | OFF)

E.g: :SOURce:CTRL:LOAD:MODE CH1,ON

Description: Set channel bleed open

Command format: [:SOURce]:CTRL:LOAD:MODE? <channel>

Description: Get the bleeder circuit mode of the selected channel

E.g: :SOURce:CTRL:LOAD:MODE? CH1

Response: ON\n

Set output status

Command format: [:SOURce]:OUTPut[:ALL:][:STATe] {ON | OFF | 0 | 1}

Description: Set the output status of all channels (ON | OFF | 0 | 1)

E.g: OUTPut 1

Description: Open output

Command format: [:SOURce]:OUTPut[:ALL:][:STATe]?

Description: Get the output status of all channels

E.g: OUTPut?

Response: 0\n

Set output ON delay

Command format: [:SOURce]: OUTPut:ON:DElay <channel>,{<value> | MINimum | MAXimum |DEFault}

Description: Set the delay time of the output ON of the selected channel

E.g: OUTPut:ON:DElay CH1,3

Description: Set the output ON delay to 3 seconds

Command format: [:SOURce]: OUTPut:ON:DELay? <channel>

Description: Obtain the delay time of the selected channel's output ON

E.g: OUTPut:ON:DELay?

Response: 4.000000\n

Set output OFF delay

Command format: [:SOURce]: OUTPut:OFF:DELay <channel>,{<value> | MINimum | MAXimum | DEFault}

Description: Set the delay time for output OFF of the selected channel

E.g: OUTPut:OFF:DELay CH1,1

Description: Set output OFF delay less than 1 second

Command format: [:SOURce]: OUTPut:OFF:DELay? <channel>

Description: Obtain the delay time of output OFF of the selected channel

E.g: OUTPut:OFF:DELay?

Response: 3.000000\n

Set the output enable state of the channel

Command format: [:SOURce]: OUTPut:OFF:DELay <channel>,{ON | OFF | 0 | 1}

Description: Set the channel output enable state of the selected channel (ON | OFF | 0 | 1)

E.g: OUTPut:SET:ON:STATE CH1,1

Description: Set CH1 output enable on

Command format: [:SOURce]:OUTPut:SET:ON:STATE? <channel>

Description: Get the channel output enable status of the selected channel

E.g: OUTPut:SET:ON:STATE? CH1

Response: 1\n

Set external output enable state

Command format: [:SOURce]:OUTPut:LOCAL:ENable <channel>,{ON | OFF | 0 | 1}

Description: Set the external output enable state of the selected channel (ON | OFF | 0 | 1)

E.g: OUTPut:LOCAL:ENable CH1,0

Description: Set CH1 channel to external control mode

Command format: [:SOURce]:OUTPut:LOCAL:ENable? <channel>

Description: Get the external output enable status of the selected channel

E.g: OUTPut:LOCAL:ENable? CH1

Response: 1\n

Set internal resistance

Command format: [:SOURce]:INIT:RESistance <channel>,{<value> | MINimum | MAXimum | DEFAULT}

Description: Set the internal resistance of the selected channel

E.g: INIT:RESistance CH1,2

Description: Set the internal resistance of CH1 channel to 2Ω

Command format: [:SOURce]:INIT:RESistance? <channel>

Description: Get the internal resistance value of the selected channel

E.g: INIT:RESistance? CH1

Response: 2.000000\n

Set channel CC/CV priority mode

Command format: [:SOURce][:CVCC]:PRIOrity <channel>,{CC | CV }

Description: Set the CC/CV priority of the selected channel (CC | CV)

E.g: PRIOrity CH1,CC

Description: Set the operation mode to CC priority

Command format: [:SOURce][:CVCC]:PRIOrityq? <channel>

Description: Get the CC/CV priority of the selected channel

E.g: PRIOrityq?

Response: CC\n

Set the measurement average

Command format: SYStem:MEASure:AVERage { LOW | MIDDLE | HIGH }

Description: Set the average measurement value (LOW | MIDDLE | HIGH)

E.g: SYStem:MEASure:AVERage LOW

Command format: SYStem:MEASure:AVERage?

Description: Get average measurement value

E.g: SYStem:MEASure:AVERage?

Restore the current protection status of the specified channel

Command format: [:SOURce]:RESET:CHANnel:PROTeCt <channel>

Description: Restore the circuit protection status of the selected channel

E.g: RESET:CHANnel:PROTeCt

Restore the circuit protection status of all channels

Command format: [:SOURce]:RESET:CIRCuit:PROTeCt

Description: Restore the circuit protection status of all channels

E.g: RESET:CIRCuit:PROTeCt

List Configuration Command Subsystem**Set channel List mode status**

Command format: [:SOURce]:LIST[:STATe] <channel>,{ON | OFF | 0 | 1}

Description: Set the List mode status of the selected channel (ON|OFF|0|1)

E.g: LIST CH1,1

Description: Set CH1 channel to List mode

Command format: [:SOURce]:LIST[:STATe]? <channel>

Description: Get the List mode status of the selected channel

E.g: LIST? CH1

Response: 1\n

Set list output enable status

Command format:

Description:

E.g:

Description:

Command format:

Description:

E.g:

Response:

Set the total number of steps in List

Command format: [:SOURce]:LIST:STEP <channel>,{<value> | MINimum | MAXimum | DEFault}

Description: Set the number of List steps of the selected channel

E.g: LIST:STEP CH1,2

Description: Set the total number of steps in List to 2

Command format: [:SOURce]:LIST:STEP? <channel>

Description: Get the number of List steps of the selected channel

E.g: LIST:STEP? CH1

Response: 2\n

Set the number of cycles

Command format: [:SOURce]:LIST:CYCLES <channel>,[:COUNT]

Description: Set the number of cycles

E.g: LIST:CYCLES CH1,3

Description: Set the list steps cycle of CH1 to 3 times

Command format: [:SOURce]:LIST:CYCLES[:COUNT]? <channel>

Description: Gets the number of return list cycles

E.g: LIST:CYCLES? CH1

Response: 3\n

Set the specified number of steps List voltage value

Command format: [:SOURce]:LIST:VOLTage <channel>,<step>,{<value> | MINimum | MAXimum | DEFault}

Description: Set the voltage setting value of the current step number of the selected channel List

E.g: LIST:VOLTage CH1,1,9

Description: Set 1 step voltage value to 9V

Command format: [:SOURce]:LIST:VOLTage? <channel>,<step>

Description: Get the voltage setting value of the current step number of the selected channel List

E.g: LIST:VOLTage? CH1,1

Response:9.000000\n

Set the current value of the specified number of steps

Command format: [:SOURce]:LIST:CURRent <channel>,<step>,<value> | MINimum | MAXimum | DEFault}

Description: Set the current setting value of the current step number of the selected channel List

E.g: LIST:CURRent CH1,1,5

Description: Set the current value of step 1 to 5A

Command format: [:SOURce]:LIST:CURRent? <channel>,<step>

Description: Get the current setting value of the current step number of the selected channel List

E.g: LIST:CURRent? CH1,1

Response: 5.000000\n

Set the running time of the specified number of steps

Command format: [:SOURce]:LIST:WIDth <channel>,<step>,<value> | MINimum | MAXimum | DEFault}

Description: Set the running time of the current step number of the selected channel List

E.g: LIST:WIDth CH1,1,30

Description: Set the running time of step 1 to 30 seconds

Command format: [:SOURce]:LIST:WIDth? <channel>,<step>

Description: Get the running time of the current step number of the selected channel List

E.g: LIST:WIDth? CH1,1

Response: 30.000000\n

Set the delay time of the specified number of steps

Command format: [:SOURce]:LIST:DELAy <channel>,<step>,<value> | MINimum | MAXimum | DEFault}

Description: Set the delay time of the current step number of the selected channel List

E.g: LIST:DELAy CH1,1,9

Description: Set the delay time of step 1 to 9 seconds

Command format: [:SOURce]:LIST:DELAy? <channel>,<step>

Description: Get the delay time of the current step number of the selected channel List

E.g: LIST:DELAy? CH1,1

Response:9.000000\n

Set the voltage rise slope for the specified number of steps

Command format: [:SOURce]:LIST:VOLTage:RISE:SLOPe <channel>,<step>,{<value> | MINimum | MAXimum | DEFault}

Description: Set the voltage rise slope value of the selected channel steps in list mode

E.g: LIST:VOLTage:RISE:SLOPe CH1,1,160

Description: Set the voltage rise slope of step 1 of channel 1 to 160V / s

Command format: [:SOURce]:LIST:VOLTage:RISE:SLOPe? <channel>,<step>

Description: Obtain the voltage rise slope value of the selected channel steps in list mode

E.g: LIST:VOLTage:RISE:SLOPe? CH1,1

Response: 160.000000\n

Set the voltage fall slope for the specified number of steps

Command format: [:SOURce]:LIST:VOLTage:FALL:SLOPe <channel>,<step>,{<value> | MINimum | MAXimum | DEFault}

Description: Set the voltage fall slope value of the selected channel steps in list mode

E.g: LIST:VOLTage:FALL:SLOPe CH1,1,160

Description: Set the voltage fall slope of step 1 of channel 1 to 160V / s

Command format: [:SOURce]:LIST:VOLTage:FALL:SLOPe? <channel>,<step>

Description: Obtain the voltage fall slope value of the selected channel steps in list mode

E.g: LIST:VOLTage:FALL:SLOPe? CH1,1

Response:160.000000\n

Set the current rise slope for the specified number of steps

Command format: [:SOURce]:LIST:CURREnt:RISE:SLOPe <channel>,<step>,{<value> | MINimum | MAXimum | DEFault}

Description: Set the current rise slope value of the selected channel steps in list mode

E.g: LIST:CURREnt:RISE:SLOPe CH1,1,30

Description: Set the current rise slope of step 1 of channel 1 to 30A / s

Command format: [:SOURce]:LIST:CURRent:RISE:SLOPe? <channel>,<step>

Description: Obtain the current rise slope value of the selected channel steps in list mode

E.g: LIST:CURRent:RISE:SLOPe? CH1,1

Response: 30.000000\n

Set the current fall slope for the specified number of steps

Command format: [:SOURce]:LIST:CURRent:FALL:SLOPe <channel>,<step>,{<value> | MINimum | MAXimum | DEFault}

Description: Set the current fall slope value of the selected channel steps in list mode

E.g: LIST:CURRent:FALL:SLOPe CH1,1,30

Description: Set the current fall slope of step 1 of channel 1 to 30A / s

Command format: [:SOURce]:LIST:CURRent:FALL:SLOPe? <channel>,<step>

Description: Obtain the current fall slope value of the selected channel steps in list mode

E.g: LIST:CURRent:FALL:SLOPe? CH1,1

Response: 30.000000\n

System Configuration Command Subsystem

Button sound settings

Command format: MENU:SOUND:KEY {ON | OFF | 0 | 1}

Description: Set the button sound switch state

E.g: MENU:SOUND:KEY 1

Description: Set open key sound

Command format: MENU:SOUND:KEY?

Description: Get button sound switch status

E.g: MENU:SOUND:KEY?

Response: 1\n

Set warning sound

Command format: MENU:SOUND:ALARm {ON | OFF | 0 | 1}

Description: Set warning sound switch state

E.g: MENU:SOUND:ALARM 1

Description: Set warning sound on

Command format: MENU:SOUND:ALARM?

Description: Get warning sound switch status

E.g: MENU:SOUND:ALARM?

Response: 1\n

Get network port connection status

Command format: LAN:LINK?

Description: Get the connection status of the network port

E.g: LAN:LINK?

Response: 1\n

DHCP setting

Command format: DHCP {ON | OFF | 0 | 1}

Description: Set to dynamically obtain IP status

E.g: DHCP 1

Description: Set to open the DHCP function

Command format: DHCP?

Description: Get dynamic IP status

E.g: DHCP?

Response: 1\n

Set IP address

Command format: LAN:IPADddress <value>

Description: Set IP address

E.g: LAN:IPADddress 10.11.13.213

Command format: LAN:IPADddress?

Description: Get IP address

E.g: LAN:IPADddress?

Set the subnet mask

Command format: LAN:SMASK <value>

Description: Set the subnet mask

E.g: LAN:SMASK 255.255.255.0

Command format: LAN:SMASK?

Description: Get the subnet mask

E.g: LAN:SMASK?

Set up the gateway

Command format: LAN:GATeway <value>

Description: Set up the gateway

E.g: LAN:GATeway 10.11.13.1

Command format: LAN:GATeway?

Description: Get the gateway

E.g: LAN:GATeway?

Set MAC address

Command format: LAN:MAC <value>

Description: Set MAC address

E.g: LAN:MAC 00:00:00:00:a0:42

Command format: LAN:MAC?

Description: Get MAC address

E.g: LAN:MAC?

Set GPIB address

Command format: GPIB:ADDRess <value>

Description: Set GPIB address

E.g: GPIB:ADDRess 3

Command format: GPIB:ADDRess?

Description: Get GPIB address

E.g: GPIB:ADDRess?

Restore factory settings data

Command format: FACTory:RESET

Description: Restore factory settings data

E.g: FACTory:RESET

Restore default data

Command format: DEFAult:RESET

Description: Restore default setting data

E.g: DEFAult:RESET

Set master-slave series-parallel mode

Command format: SYStem:DEVIce:ROLE <channel>,{ M_INDEPEN | M_PAREL_1 | M_PAREL_2 | M_SERIES | S_PAREL | S_SERIES }

Description: Set the master-slave series-parallel mode of the selected channel

E.g: SYStem:DEVIce:ROLE CH1,M_INDEPEN

Command format: SYStem:DEVIce:ROLE? <channel>

Description: Get the master-slave series-parallel mode of the selected channel

E.g: SYStem:DEVIce:ROLE? CH1

Get slave version information

Command format: SYStem:SLAVE:VERsion? <channel>

Description: Get the selected channel slave version

E.g: SYStem:SLAVE:VERsion? CH1

Web Service

The SPS5000X can be remotely controlled through its embedded web control interface.

The first connection method:

The PC computer is not connected to the network, and the SPS5000X and the PC computer are directly connected through a network cable(cross-over cable). First, set up the computer.

The following takes the Windows 7 system as an example:

- 1) Open the Network Sharing Center in the control panel and click Change adapter settings

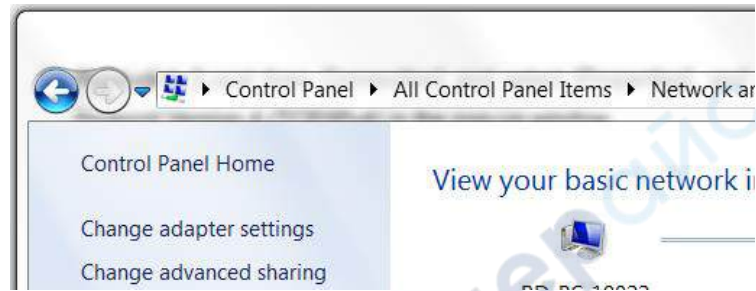

- 2) Right-click [Local Area Connection] and select [Properties], and double-click Internet Protocol Version 4 (TCP/IPv4) in the pop-up window

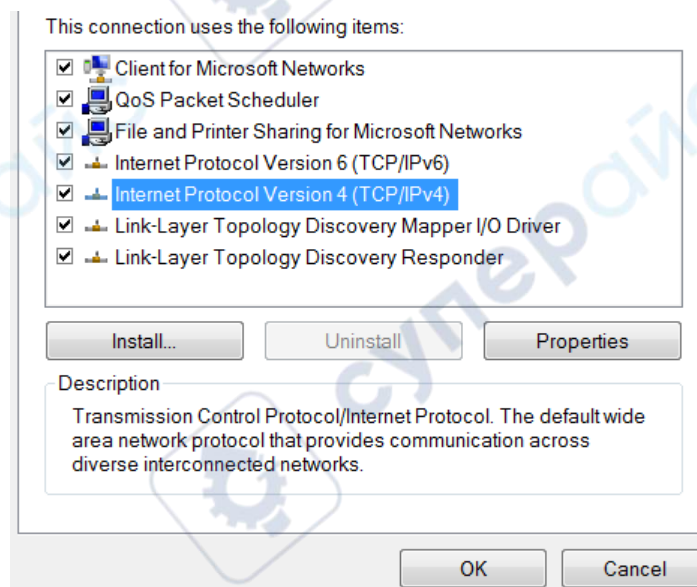

- 3) Select [Use the following IP address] to set the IP address, subnet mask and default gateway, and click OK after setting
- 4) The PC computer setting is completed.

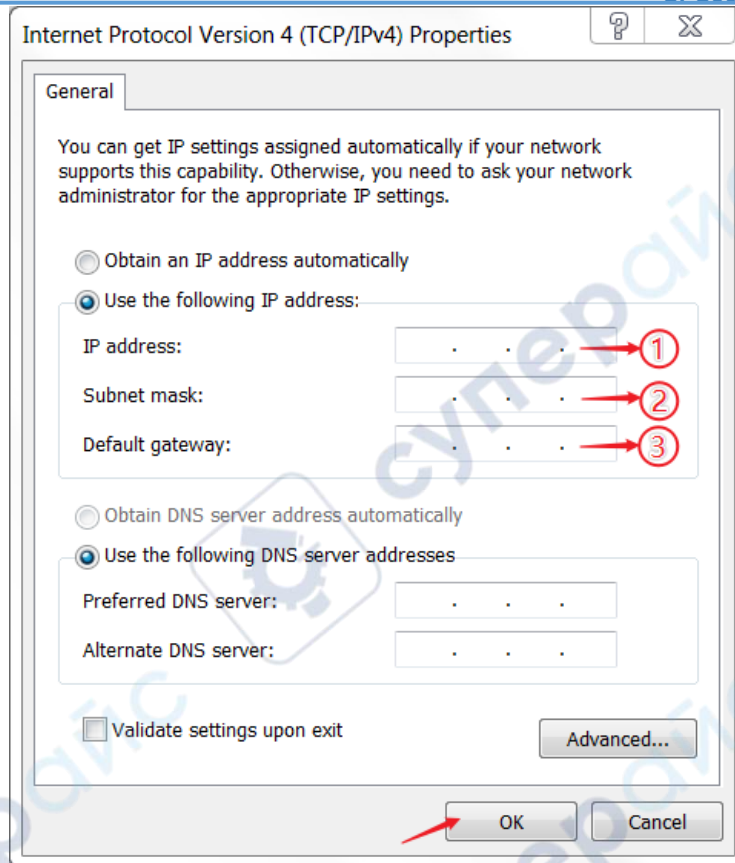

- ① Set an IP address different from SPS
- ② Set the same subnet mask as SPS
- ③ Set the same gateway as SPS

Set the SPS power supply

Refer to the previous chapter [9.3.3] LAN settings, manually set SPS to be the same as the PC computer subnet mask and default gateway, and set a different IP address. At this point, the PC and SPS settings are completed, and the web page can be opened for remote control.

The second connection method:

SPS and PC are connected to the same network, SPS can automatically obtain IP or manually change the IP address to be connected.

Web interface

After obtaining the IP address of the SPS5000X by any of the above methods, open the Google browser on the PC and directly enter the IP address in the input field to enter.

After configuring the voltage and current on the main interface, you need to click the arrow at the arrow to submit, and the data will be sent to the power supply.

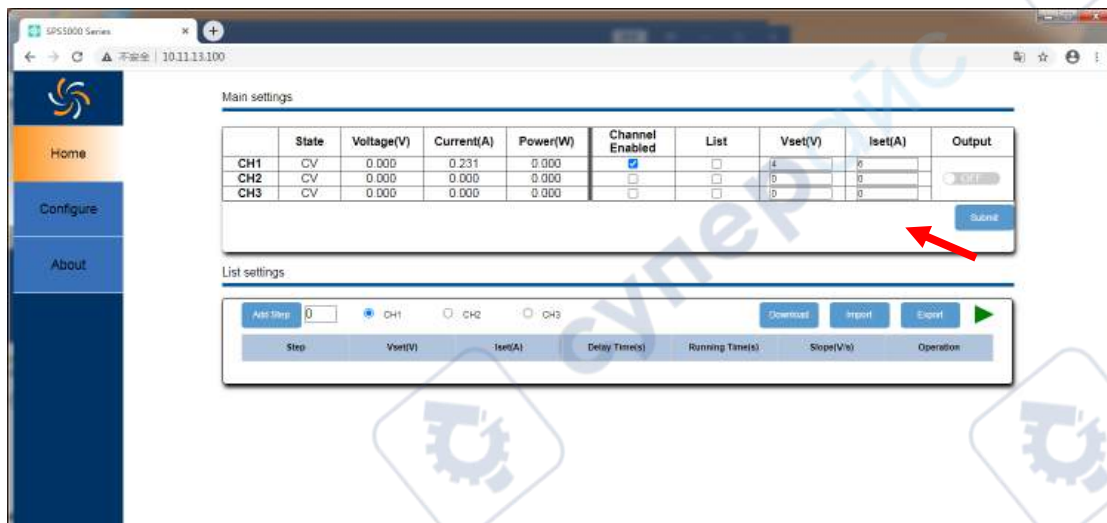

List operation method:

1) Set the channel mode to List mode. Select List, click Submit

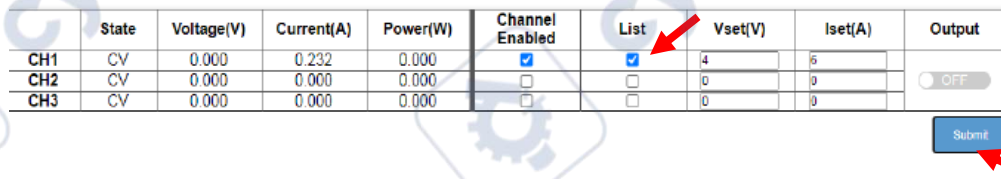

2) Add the number of List steps, if it is a multi-channel model, select the channel to be set

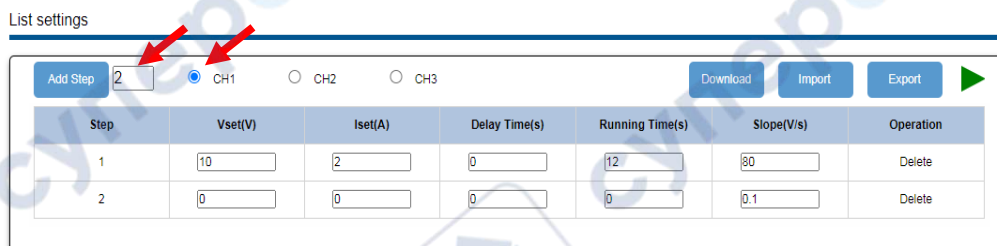

3) Set the voltage and current parameters of each step, and click Download after the output is completed to send the List data to the power supply

List settings

Add Step CH1 CH2 CH3 Download Import Export ▶

Step	Vset(V)	Iset(A)	Delay Time(s)	Running Time(s)	Slope(V/s)	Operation
1	<input type="text" value="10"/>	<input type="text" value="2"/>	<input type="text" value="0"/>	<input type="text" value="12"/>	<input type="text" value="80"/>	Delete
2	<input type="text" value="0"/>	<input type="text" value="0"/>	<input type="text" value="0"/>	<input type="text" value="0"/>	<input type="text" value="0.1"/>	Delete

4) Turn on the Output switch of the channel and click Submit. After the setting is successful, the power supply sets the output according to the number of List steps, and the setting is completed.

Main settings

	State	Voltage(V)	Current(A)	Power(W)	Channel Enabled	List	Vset(V)	Iset(A)	Output
CH1	CV	0.000	0.232	0.000	<input checked="" type="checkbox"/>	<input checked="" type="checkbox"/>	<input type="text" value="4"/>	<input type="text" value="6"/>	<input checked="" type="checkbox"/>
CH2	CV	0.000	0.000	0.000	<input type="checkbox"/>	<input type="checkbox"/>	<input type="text" value="0"/>	<input type="text" value="0"/>	<input type="checkbox"/>
CH3	CV	0.000	0.000	0.000	<input type="checkbox"/>	<input type="checkbox"/>	<input type="text" value="0"/>	<input type="text" value="0"/>	<input type="checkbox"/>

Submit

Operating:

Click [Configure] in the left column to switch to the configuration interface

If it is a multi-channel model, select the channel to be configured at the top bar.

After performing function configuration on the Configure interface, you need to click Submit at the arrow to send the data to the power supply.

Click [About] in the left column to view device information

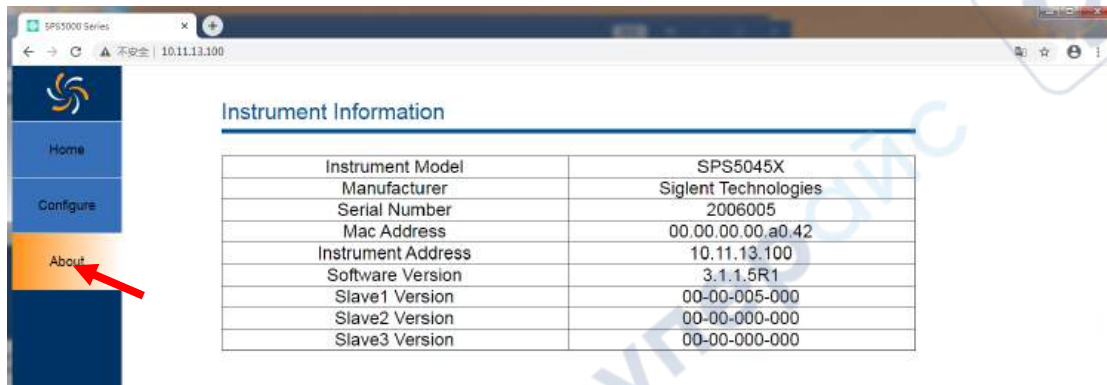

List file export

The SPS webpage supports exporting the settings of the voltage, current, delay time, running time and slope of the List steps to the outside in the form of .csv, and click Export to start the export operation.

The exported .csv file supports editing. After opening the .csv file, the user can customize the number of steps and other settings according to the format and then apply it to SPS.

List settings

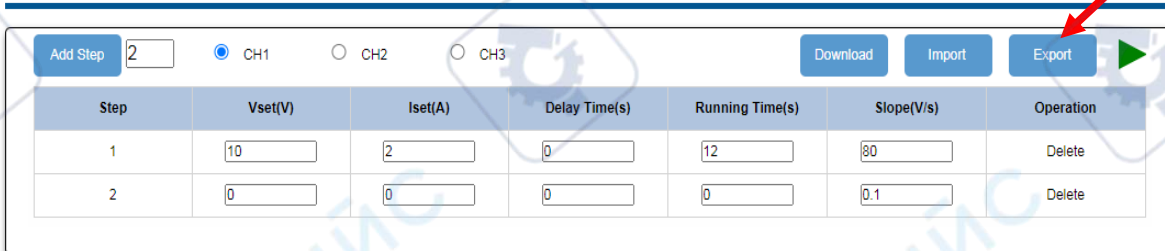

Click Import on the webpage and find the file path, then you can import the edited .csv file and apply it to SPS.

List settings

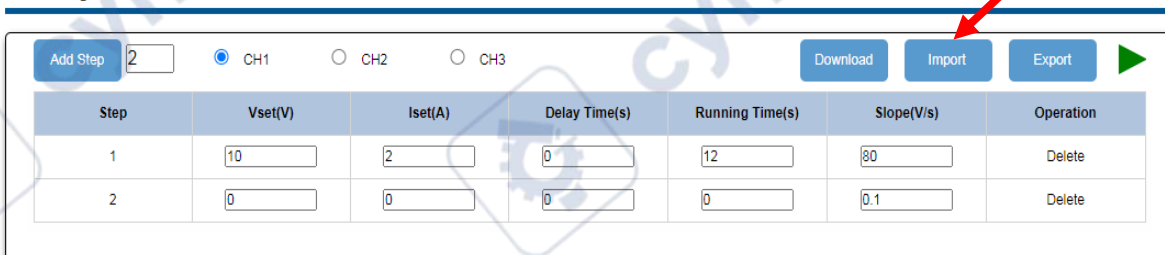

In addition, the exported .CSV file can also be copied to a USB flash drive, and the application of List storage data can also be realized by inserting the USB flash drive into the power supply for external calling.

Troubleshooting

The following lists the power supply in the use of the process of possible failures and troubleshooting. When you encounter these faults, please follow the corresponding steps to deal with them. If you can't handle them, please contact siglent in time.

A. If the power on key is pressed, the power supply is still black, and there is no display:

- Check whether the power connector is connected properly.
- After checking, please restart the power supply.
- If the power supply can not be started normally, please contact SIGLENT.

B. No voltage output by output

- Check whether the voltage and current settings are correct
- Check whether the supply is in host mode, whether EXT on/off is in the off state, Volt_ctrl and Curr_ctrl are in Local state, whether the output resistance is set properly, whether the output delay time is too large, and the slope mode setting is too small, which causes the output voltage to rise slowly.
- Use the default setting to reset the voltage and current output after restoring the factory settings.
- If the power supply still cannot be used normally, please contact SIGLENT.

C. U disk cannot be recognized:

- Check whether the U disk device can work normally.
- Check whether the power USB HOST interface is working properly.
- Make sure that the flash-type U disk is used, and the power supply does not support hard disk-type U disk devices.
- Re-plug the U disk, or restart the power and insert the U disk again.
- If you still cannot use the U disk normally, please contact SIGLENT.