

UNI-T®



**UT305A+
UT305C+
Infrared Thermometer
User Manual**

P/N:110401110856X

PREFACE

Thank you for purchasing the new UT305A+/UT305C+ infrared thermometer. In order to use this product safely and correctly, please read this manual thoroughly, especially the Safety Instructions part.

After reading this manual, it is recommended to keep the manual at an easily accessible place, preferably close to the device, for future reference.

LIMITED WARRANTY AND LIABILITY

Uni-Trend guarantees that the product is free from any defect in material and workmanship within one year from the purchase date. This warranty does not apply to damages caused by accident, negligence, misuse, modification, contamination and improper handling. The dealer shall not be entitled to give any other warranty on behalf of Uni-Trend. If you need warranty service within the warranty period, please contact your seller directly.

This warranty is the only compensation you can obtain. Uni-Trend will not be responsible for any special, indirect, incidental or subsequent damage or loss caused by any reason or speculation. As some areas or countries do not allow limitations on implied warranties and incidental or subsequent damage, the above limitation of liability and stipulation may not apply to you.

Table of Contents

1. Overview	4
2. Safety Instructions	4
3. Product Structure	5
4. LCD Indicators/Icons	6
5. Features	7
6. Specifications	7
7. Power on/off	9
8. Measurement	9
9. Laser on/off	10
10. Save	10
11. Mode	11
12. Menu	14
13. Data Download	16
14. D: S (Distance to Spot Ratio)	17
15. Field of View	17
16. Emissivity	18
17. Maintenance and Cleaning	20
18. Charging	20
19. Troubleshooting	20
20. Notes	20

1. Overview

UT305A+/UT305C+ infrared thermometer (hereinafter referred to as "thermometer" or "product") is suitable for non-contact temperature measurement. It can determine the surface temperature of the target by measuring the infrared energy radiated by the target surface. The thermometer also supports contact temperature measurement with a type K thermocouple. Besides, it can measure the ambient temperature and relative humidity, and calculate the dew point temperature and wet bulb temperature.

2. Safety Instructions

Warning:

To prevent eye damage or personal injury, please read the following safety instructions before using the product:

- Do not point the laser directly at persons or animals or indirectly through reflective surfaces.
- Do not look directly at the laser or with optical tools (binoculars, microscopes, etc.).



Cautions:

- If the laser irradiates the user's eyes, please close the eyes immediately and turn the head away.
- Do not disassemble or refit the product and laser without permission.
- To ensure its safety and accuracy, this product should only be repaired by professional maintenance personnel using original replacement parts.
- Charge immediately when the low battery indicator shows to prevent incorrect measurements.
- Please check the product before using it. If it is damaged, cracked on the surface or missing plastic parts, do not use it.
- Please refer to the emissivity information for the actual temperature. Highly reflective objects or transparent materials will make the actual temperature higher than the measured temperature. When measuring these objects, pay attention to the risk of burns.
- Do not use the product in an environment with flammable and explosive liquid, gas or dust.
- Do not use the product around the environment with steam, dust, or large temperature fluctuations. It may bring inaccurate results and risks.
- Put the product in the current environment for more than 30 minutes before using it to ensure measurement accuracy.
- Do not leave the thermometer on or near objects of high temperature.

3. Product Structure

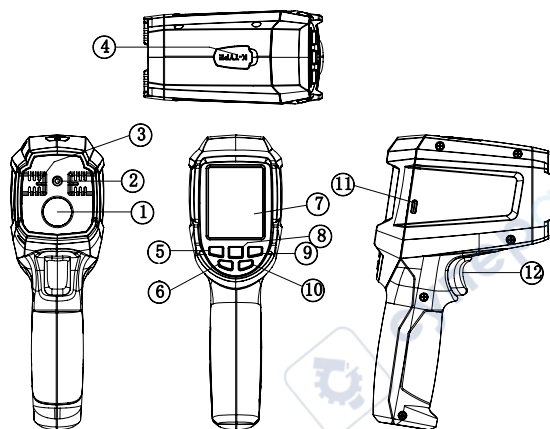

NO.	Description	NO.	Description
1	Infrared receiving window	7	LCD
2	Laser emitting aperture	8	OK
3	Temperature and humidity measurement area	9	Right
4	Type K thermocouple interface	10	Return
5	Left	11	Type-C interface
6	Power	12	Trigger

4. LCD Indicators/Icons

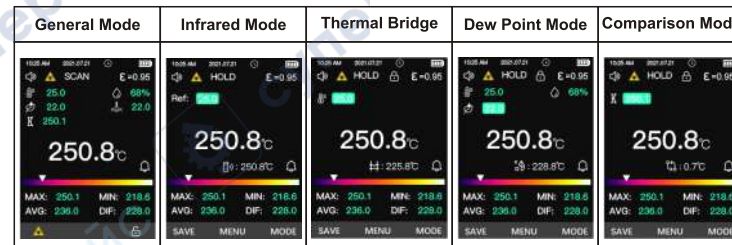

Item	Description	Item	Description
10:25 AM 2021.07.21	Date and time	🌡️ 25.0	Ambient temperature
🔊	Audio alarm	💧 68%	Relative humidity
⚠️	Laser	🌀 22.0	Dew point temperature
SCAN	Temperature measurement	💧 22.0	Wet bulb temperature
🕒	Appointment	⚖️ 250.1	Type K thermocouple temperature
🔋	Battery status	🌡️ 250.8°C	Infrared temperature
🔒	Lock measurement	MAX: 250.1	Maximum
🔔	Alarm	MIN: 218.6	Minimum
🌈	Range bar	AVG: 236.0	Average
Ref: 25.0	Reference temperature (IR-Ref)	DIF: 228.0	Difference
📄 : 250.8°C	Difference (IR-Ref)	⚖️ : 225.8°C	Difference (IR-AT)
🌡️ : 228.8°C	Difference (IR-DP)	📏 : 0.7°C	Difference (comparison mode)

5. Features

- In infrared mode, the thermometer can quickly compare and detect the surface temperature.
- In thermal bridge mode, the thermometer can detect the thermal insulation performance of various devices. It is suitable for furnaces, thermal transmission pipelines, building thermal bridge effects, cold storage, textiles and clothing thermal conductivity, personnel or food transportation tools (trucks, aircraft, etc.), greenhouse, floor heating and other fields.
- In dew point mode, the thermometer can determine whether there is dew risk on the surface of the object or the wall to prevent water leakage and mildew.
- In comparison mode, the thermometer can compare infrared temperature and type K thermocouple temperature. This mode is suitable for surface temperature comparison, emissivity adjustment, etc.
- 12H or 24H time format
- Trigger lock, suitable for processes that require temperature monitoring
- 999 groups of data storage, can export data into PDF and csv files
- Appointment measurement
- High precision display of ambient temperature, relative humidity, dew point temperature and wet bulb temperature
- Type K thermocouple measurement

6. Specifications

Model		UT305C+	UT305A+
Range	Infrared measurement	-50°C ~ 2200°C (-58°F ~ 3992°F)	-50°C ~ 1850°C (-58°F ~ 3362°F)
	Ambient temperature	-10°C ~ 50°C (14°F ~ 122°F)	
	Relative humidity	10%RH~90%RH	
	Type K thermocouple	-50°C ~ 1370°C (-58°F ~ 2498°F)	
Accuracy	Infrared measurement	$<0^{\circ}\text{C} : \pm (1.0^{\circ}\text{C} + 0.1^{\circ}\text{C}/^{\circ}\text{C})$ $<32^{\circ}\text{F} : \pm (2.0^{\circ}\text{F} + 0.1^{\circ}\text{F}/^{\circ}\text{F})$ $\geq 0^{\circ}\text{C} : \pm 1.0^{\circ}\text{C}$ or $\pm 0.01^{\circ}\text{t}^{\circ}\text{C}$ whichever is greater $\geq 32^{\circ}\text{F} : \pm 2.0^{\circ}\text{F}$ or $\pm 0.01^{\circ}\text{t}^{\circ}\text{F}$ whichever is greater	
	Ambient temperature	-10°C~0°C (14°F~32°F) : $\pm 1^{\circ}\text{C}$ ($\pm 2^{\circ}\text{F}$) 0°C~40°C (32°F~104°F) : $\pm 0.5^{\circ}\text{C}$ ($\pm 1^{\circ}\text{F}$) 40°C~50°C (104°F~122°F) : $\pm 1^{\circ}\text{C}$ ($\pm 2^{\circ}\text{F}$)	
	Relative humidity	$\pm 5\%RH$	
	Type K thermocouple	$\pm (0.005 \times t + 1.5)^{\circ}\text{C}$ $\pm (0.005 \times t + 3.0)^{\circ}\text{F}$	
D:S ratio		55:1 (90% of energy)	
Emissivity		0.1~1.0 adjustable, step length 0.01, built-in emissivity table	

Spectral response	8μm~14μm
Repeatability	0.005×t°C (°F) or 0.5°C (1°F) whichever is greater
Resolution	0.1°C
Unit	°C/°F
Laser	Single laser, class 2 λ=630-670nm, < 1mW, EN60825-1:2014
Data storage	999 groups
Data export formats	PDF, csv
Data communication/ charging interface	Type-C USB
Battery	3.7V 2600mAh 18650 rechargeable lithium battery
Charging time	≤3h
Continuous operating time	≥20h (fully charged)
Alarm	Buzzer
Trigger lock	√
Appointment measurement	√
Real-time date and time	√
Display type	2.4" TFT LCD
Display resolution	320*240 pixels
Storage temperature	-20°C~60°C (-4°F~140°F)
Operating temperature	-10°C~50°C (14°F~122°F)
Operating humidity	< 90%RH (non-condensing)
Temperature coefficient	$\pm 0.1^{\circ}\text{C}/^{\circ}\text{C}$ or $\pm 0.1\%/^{\circ}\text{C}$ whichever is greater
Operating altitude	≤2000m
Drop proof test	1m
Product weight	375g
Product size	124mm(L)×65mm(W)×205mm(H)
CE certification	EN/IEC 61326-1:2013EN/IEC 60825-1:2014
Accessories	User manual, USB cable, type K bead thermocouple
Type K bead thermocouple	
Range	-40°C~260°C (-40°F~500°F)
Accuracy	0.075×t (t is the measured temperature)
Length	1m (40in) type K thermocouple cable with standard micro thermocouple connector and bead probe

7. Power on/off

Long press the Power button (6) for 1.5s to power on the thermometer.
After the thermometer is turned on, long press the Power button (6) for 3s to power off.
Or it automatically shuts down according to the preset auto power off time when no operation is performed.

8. Measurement

After the thermometer is turned on, aim it at the object and press the trigger (12) to take a measurement. Users can turn on the laser to make the thermometer more accurately targeted. The measurement distance is determined by the size of the measured target. Hold the trigger and move the thermometer slowly to scan the high and low temperature spots of the target. The MAX, MIN, AVG and DIF values will be displayed on the screen. Release the trigger (12) to hold the measured value.

Lock measurement:

When the lock measurement function is turned on, the thermometer will measure continuously until the function is turned off.

Turn on lock measurement:

Press and hold the trigger (12). When an icon  shows in the lower right corner of the screen, press the Right button (9) to turn on the lock measurement function.

Turn off lock measurement:

Press the Right button (9) to turn off the lock measurement function. Or it will automatically turn off when the preset lock measurement time is reached. The measured value will hold on the screen after the function is turned off.



9. Laser on/off

Turn on the laser:

When the trigger (12) is pressed for measurement, press the Left button (5) to turn on the laser.

Turn off the laser:

When the trigger (12) is pressed for measurement, press the Left button (5) to turn off the laser. The laser icon  will disappear.



10. Save

After the measurement is completed, SAVE will be displayed in the lower left corner of the screen. Press the Left button (5) to enter the saving interface.

In the saving interface, press the Left button (5) or Right button (9) to select the sequence number to be saved, and then press the OK button (8) to save. Press the Return button (10) to return to the HOLD interface.

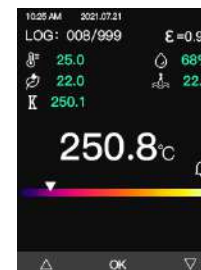

11. Mode

In the HOLD interface, MODE will be displayed in the lower right corner of the screen. Press the Right button (9) to enter the mode selection interface. Press the Left button (5) or Right button (9) to step through modes, and press the OK button (8) to enter the selected mode. Press the Return button (10) or press the trigger (12) to return to the previous mode.

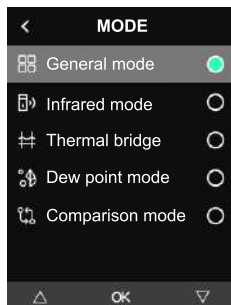

General mode:

This mode is suitable for most users and can measure ambient temperature, relative humidity, dew point temperature, wet bulb temperature, type K thermocouple temperature and infrared temperature. When the infrared measured value exceeds the high or low limit set in this mode, the buzzer will beep.

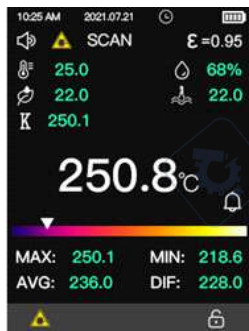

Infrared mode (IR-Ref):

In this mode, measure the reference temperature (Ref) first. If the reference temperature needs to be changed, press the Return button to clear it and measure again. Then measure the temperature of the detected object. The thermometer automatically calculates a difference (IR-Ref) by subtracting the temperature of the object being measured (IR) from the reference temperature (Ref). When the difference exceeds the high or low limit set in this mode, the buzzer will beep.



Thermal bridge (IR-AT):

In this mode, the thermometer automatically calculates a difference (IR-AT) by subtracting the temperature of the object being measured (IR) from the current ambient temperature (AT). When the difference exceeds the high or low limit set in this mode, the buzzer will beep.

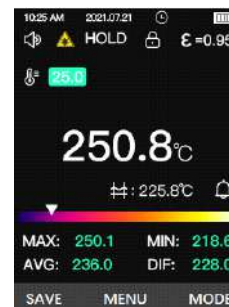

Dew point mode (IR-DP):

In this mode, the thermometer automatically calculates a difference (IR-DP) by subtracting the temperature of the object being measured (IR) from the current dew point temperature (DP). When the difference exceeds the high or low limit set in this mode, the buzzer will beep.



Comparison mode (IR-KT):

In this mode, the thermometer automatically calculates a difference (IR-KT) by subtracting the temperature of the object being measured (IR) from the type K thermocouple temperature (KT). When the difference exceeds the high or low limit set in this mode, the buzzer will beep.



12. Menu

In the HOLD interface, MENU will be displayed in the middle bottom of the screen. Press the OK button (8) to open the menu.

In the menu, press the Left (5) or the Right button (9) to step through options. Press the OK button (8) to enter the option setting interface. Press the Return button (10) or the trigger (12) to return to the HOLD interface.

Language:

The optional languages include Chinese and English. In the language setting interface, press the Left (5) or the Right button (9) to select a language, and then press the OK button (8) to confirm. Press the Return button (10) return to the menu, or press the trigger (12) to return to the HOLD interface.

Time and date:

The optional time formats include 12H and 24H. In the time and date setting interface, press the Left (5), the Right (9) and the OK (8) buttons to set. Press the Return button (10) return to the previous interface, or press the trigger (12) to return to the HOLD interface.

Temperature unit:

The optional temperature units include °C and °F. In the temperature unit setting interface, press the Left (5), the Right (9) and the OK (8) buttons to set. Press the Return button (10) return to the previous interface, or press the trigger (12) to return to the HOLD interface.

HI/LO alert:

In the HI/LO alert setting interface, press the Left (5), the Right (9) and the OK (8) buttons to set the upper limit and lower limit in the current mode. Press the Return button (10) return to the previous interface, or press the trigger (12) to return to the HOLD interface.

Emissivity:

In the emissivity setting interface, press the Left (5), the Right (9) and the OK (8) buttons to set the desired emissivity. Users can also select the reference values listed in the emissivity table. Press the Return button (10) return to the previous interface, or press the trigger (12) to return to the HOLD interface.

Appointment:

In the appointment setting interface, users can set the appointment parameters, inquire and format the previous appointment data.

Appointment inquiry:

In the appointment setting interface, press the OK button (8) to enter the inquiry interface. Press the Left (5) or the Right (9) button to select the inquiry location. The measured value, date and time stored in this location can be viewed. Press the OK button (8) to delete this group of data. Press the Return button (10) return to the previous interface, or press the trigger (12) to return to the HOLD interface.

Appointment format:

In the appointment setting interface, press the OK button (8) to enter the format interface. Press the Left (5) or the Right (9) button to select YES or NO, and then press the OK button (8) to confirm. Press the Return button (10) return to the previous interface, or press the trigger (12) to return to the HOLD interface.

Appointment settings:

In the appointment setting interface, press the OK button (8) to open the setting items. Press the Left (5), the Right (9) and the OK (8) buttons to set start time, interval time, number and close the appointment. Press the Return button (10) return to the previous interface, or press the trigger (12) to return to the HOLD interface. When the appointment measurement is enabled, the main interface will display its icon. When the system time reaches the set start time, the thermometer automatically starts to measure and saves the current time and measured value. It will automatically measure and save every time the set interval time is reached. When the measurement times reach the set number, the appointment function is completed and closed.

Storage:

In the storage setting interface, users can inquire and format the saved measurement data.

Inquiry:

In the storage setting interface, press the OK button (8) to enter the inquiry interface. Press the Left (5) or the Right (9) button to select the inquiry location. The measured value, date and time stored in this location can be viewed. Press the OK button (8) to delete this group of data. Press the Return button (10) return to the previous interface, or press the trigger (12) to return to the HOLD interface.

Format:

In the storage setting interface, press the OK button (8) to enter the format interface. Press the Left (5) or the Right (9) button to select YES or NO, and then press the OK button (8) to confirm. Press the Return button (10) return to the previous interface, or press the trigger (12) to return to the HOLD interface.

System settings:

In the system settings interface, users can set the sound alarm, brightness, lock time, shutdown time, factory reset and system information.

Sound alarm:

In the system settings interface, press the OK button (8) to enter the sound alarm interface. Press the Left (5) or the Right (9) button to select open or close the sound alarm, and then press the OK button (8) to confirm. Press the Return button (10) return to the previous interface, or press the trigger (12) to return to the HOLD interface.

Brightness:

In the system settings interface, press the OK button (8) to enter the brightness interface. Press the Left (5) or the Right (9) button to select higher, medium or lower, and then press the OK button (8) to confirm. Press the Return button (10) return to the previous interface, or press the trigger (12) to return to the HOLD interface.

Lock time:

In the system settings interface, press the Left (5), the Right (9) and the OK (8) buttons to set the lock time. Press the Return button (10) return to the previous interface, or press the trigger (12) to return to the HOLD interface.

Shutdown time:

In the system settings interface, press the Left (5), the Right (9) and the OK (8) buttons to set the shutdown time. Press the Return button (10) return to the previous interface, or press the trigger (12) to return to the HOLD interface.

Factory reset:

In the system settings interface, press the OK button (8) to enter the factory reset interface. Press the Left (5) or the Right (9) button to select YES or NO, and then press the OK button (8) to confirm. Press the Return button (10) return to the previous interface, or press the trigger (12) to return to the HOLD interface.

System information:

In the system settings interface, press the OK button (8) to enter the system information interface. Users can view the system version and the update time.

13. Data Download

The data stored in the thermometer can be downloaded to a PC through the attached USB cable. Plug the USB cable into the Type-C interface (11) of the product and connect the other end to the PC. Turn on the thermometer and open the menu. Press the Left (5) or the Right (9) button to select Generate table, and then press the OK button (8). After the table is generated, the appointment and manual measurement data can be viewed on the computer in PDF and CSV formats.

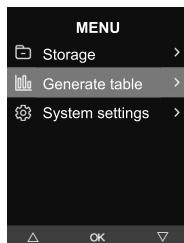

14. D: S (Distance to Spot Ratio)

As the distance (D) between the thermometer and the measured target increases, the light spot diameter (S) of the measured area also increases. The relationship between measurement distance and light spot diameter is shown in the figure below.

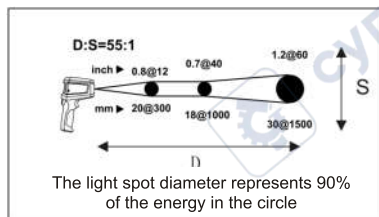

15. Field of View

When measuring, make sure that the measured target is larger than the light spot diameter. The smaller the target, the closer the test distance should be (refer to D: S for the detailed light spot diameter). It is recommended that the measured target be larger than twice the light spot diameter of the thermometer.

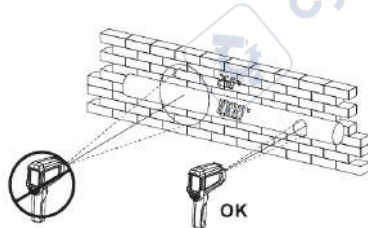

16. Emissivity

Emissivity represents the material energy radiation. The emissivity of most organic materials, painted or oxidized surfaces is about 0.95. The user can use masking tapes or flat paints to cover the metal surface, use the high emissivity setting, and then wait for a period of time to make the surface temperatures of the tapes/flat paints and the covered object the same. At this point, the surface temperature of the tapes/flat paints is equal to the metal surface temperature. The following table shows the total emissivity ϵ of some metals and non-metals.

Measured surface	Emissivity
Metals	
Aluminum	
Oxide	0.2-0.4
A3003 Alloy	
Oxide	0.3
Crude	0.1-0.3
Brass	
Polishing	0.3
Oxide	0.5
Cuprum	
Oxide	0.4-0.8
Electrical terminal board	0.6
Hastelloy	
Alloy	0.3-0.8
Inconel	
Oxide	0.7-0.95
Abrasive blasting	0.3-0.6
Electropolishing	0.15
Ferrum	
Oxide	0.5-0.9
Rusting	0.5-0.7
Ferrum (casting)	
Oxide	0.6-0.95
Non-Oxide	0.2
Casting	0.2-0.3
Ferrum (forging)	
Passivating	0.9
Plumbum	
Crude	0.4
Oxide	0.2-0.6
Molybdenum	
Oxide	0.2-0.6

Nickel	Oxide	0.2-0.5
Platinum	Black	0.9
Steel	Cold rolling	0.7-0.9
	Burnishing	0.4-0.6
	Polishing	0.1
Zinc	Oxide	0.1
Non-Metals		
Asbestos		0.95
Asphalt		0.95
Basalt		0.7
Carbon	Non-Oxide	0.8-0.9
	Graphite	0.7-0.8
	Carborundum	0.9
Ceramic		0.95
Clay		0.95
Concrete		0.95
Cloth		0.9
Glass	Convex glass	0.76-0.8
	Smooth glass	0.92-0.94
	Nonex	0.78-0.82
Sheet material		0.96
Gypsum		0.8-0.95
Ice		0.98
Limestone		0.98
Paper		0.95
Plastic		0.95
Water		0.93
Soil		0.9-0.98
Wood		0.9-0.95

17. Maintenance and Cleaning

Blow away the fallen particles with clean compressed air, carefully wipe the lens surface with a moist swab, and clean the shell with a moist sponge or soft cloth. Be careful not to rinse with water or immerse it in water.

18. Charging

This product can be charged by 5V/1A, 5V/2A or 9V/2A power adapter. Please use a safety certified power adapter to charge. Do not charge in damp environment. The battery is a consumable product. If the battery life is significantly reduced, please contact customer service to repair and replace the battery.

19. Troubleshooting

Phenomenon	Cause	Measure
Display OL	Measured value > maximum range	Stop measuring
Display -OL	Measured value < minimum range	Stop measuring
Display Err (startup)	Exceed the minimum or maximum operating temperature or the infrared or temperature and humidity sensor is damaged	Place the thermometer at -10°C-50°C (32°F-122°F) for 30 minutes or have it repaired
Battery symbol flashes	Low battery	Charging
Display Er0 (startup)	Product internal damage	Restart the product or charge and then turn it on. If it still cannot work normally, it needs to be repaired
Inaccurate measurement	Unmatched emissivity, too far measurement distance, diameter of the measurement target < 18mm	Refer to Field of View, D:S and other instructions in this manual

20. Notes

During the charging process, the internal temperature of the product rises, which will lead to the deviation of the measurement result. In order to ensure the accuracy, avoid measurement in charging state or unplug USB cable for more than 10 minutes to wait for the internal temperature to recover.

UNI-T®

UNI-TREND TECHNOLOGY (CHINA) CO., LTD.

No. 6, Gong Ye Bei 1st Road,
Songshan Lake National High-Tech Industrial
Development Zone, Dongguan City,
Guangdong Province, China

