



# **OWP\_H Series User manual**

※: The illustrations, interface, icons and characters in the user manual may be slightly different from the actual product. Please refer to the actual product.

**Aug. 2025 edition V1.0.2**

Copyright © LILLIPUT Company. All rights reserved.

The LILLIPUT's products are under the protection of the patent rights, including ones which have already obtained the patent rights and those which are applying for. The information in this manual will replace all that in the materials published originally.

The information in this manual was correct at the time of printing. However, LILLIPUT will continue to improve products and reserves the rights to change specification at any time without notice.

**owon**<sup>®</sup> is the registered trademark of the LILLIPUT Company.

**Fujian LILLIPUT Optoelectronics Technology Co., Ltd.**

No. 19, Heming Road

Lantian Industrial Zone, Zhangzhou 363005 P.R. China

**Tel:** +86-596-2130430

**Fax:** +86-596-2109272

**Web:** [www.owon.com](http://www.owon.com)

**E-mail:** [info@owon.com.cn](mailto:info@owon.com.cn)

## General Warranty

We warrant that the product will be free from defects in materials and workmanship for a period of 2 years (1 year for accessories) from the date of purchase of the product by the original purchaser from our company. This warranty only applies to the original purchaser and is not transferable to a third party.

If the product proves defective during the warranty period, we will either repair the defective product without charge for parts and labour, or will provide a replacement in exchange for the defective product. Parts, modules and replacement products used by our company for warranty work may be new or reconditioned like new. All replaced parts, modules and products become the property of our company.

In order to obtain service under this warranty, the customer must notify our company of the defect before the expiration of the warranty period. Customer shall be responsible for packaging and shipping the defective product to the designated service centre, a copy of the customers proof of purchase is also required.

This warranty shall not apply to any defect, failure or damage caused by improper use or improper or inadequate maintenance and care. We shall not be obligated to furnish service under this warranty a) to repair damage resulting from attempts by personnel other than our company representatives to install, repair or service the product; b) to repair damage resulting from improper use or connection to incompatible equipment; c) to repair any damage or malfunction caused by the use of not our supplies; or d) to service a product that has been modified or integrated with other products when the effect of such modification or integration increases the time or difficulty of servicing the product.

Please contact the nearest Sales and Service Offices for services.

**Excepting the after-sales services provided in this summary or the applicable warranty statements, we will not offer any guarantee for maintenance definitely declared or hinted, including but not limited to the implied guarantee for marketability and special-purpose acceptability. We should not take any responsibilities for any indirect, special or consequent damages.**

# Contents

1 Back Panel .....	1
1.1 Interface .....	2
1.2 Voltage compensation .....	3
1.3 Parallel connection .....	3
2 Front panel .....	4
2.1 Display area .....	4
2.1.1 Home .....	5
2.2 Operating area .....	7
2.2.1 Basic operation .....	7
3 Menu .....	9
3.1 Application (APP) .....	10
3.1.1 Step Mode .....	10
3.1.2 Charge Mode .....	11
3.1.3 Function Generator Mode .....	12
3.2 Information .....	14
3.2.1 Error Log .....	14
3.2.2 Operating Log .....	14
3.2.3 Event Log .....	14
3.3 System Setting .....	15
3.3.1 UI Setting .....	15
3.4 User Setting .....	16
3.4.1 Communication Setting .....	16
3.4.2 Function Setting .....	16
3.4.3 Protect Setting .....	20
3.4.4 Password Setting .....	22
3.4.5 Reset .....	22
4 Technical Specifications .....	23
4.1 Product parameters .....	23
4.2 Product selection .....	24
5 Appendix .....	26
5.1 Accessory .....	26
5.2 Key description .....	26
5.3 User setting list .....	28
5.4 Warning list .....	29

## Figure

Figure 1: Back Panel.....	1
Figure 2: Interface.....	2
Figure 3: Schematic diagram of voltage compensation wiring.....	3
Figure 4: Parallel schematic diagram.....	3
Figure 6: Front panel.....	4
Figure 5: Display area.....	4
Figure 7: Homes.....	5
Figure 8: Reference setting.....	7
Figure 9: Menu.....	9
Figure 10: Step Mode.....	11

## Table

Table 1: Defines of interface.....	2
Table 2: Key description.....	7
Table 3: Application mode.....	10
Table 4: Steps mode.....	10
Table 5: Charge Mode.....	11
Table 6: Sine wave generator.....	12
Table 7: Triangle wave generator.....	12
Table 8: Rectangular/pulse/trapezoidal wave generator.....	13
Table 9: Line generator.....	13
Table 10: Information.....	14
Table 11: Error log.....	14
Table 12: Operating log.....	14
Table 13: Event log.....	14
Table 14: System setting.....	15
Table 15: UI setting.....	15
Table 16: Communication setting.....	16
Table 17: Function setting.....	16
Table 18: Output timing setting.....	17
Table 19: Parallel connection.....	18
Table 20: Interface Setting.....	18
Table 21: Dry contact output.....	18
Table 22: Dry contact input.....	18
Table 23: Analog interface setting.....	19
Table 24: Protect setting.....	20
Table 25: Other protects.....	20
Table 26: Under-voltage/under-current protection.....	20
Table 27: Short-circuit protect.....	21
Table 28: Switch of protects.....	21
Table 29: Reset.....	22

# 1 Back Panel

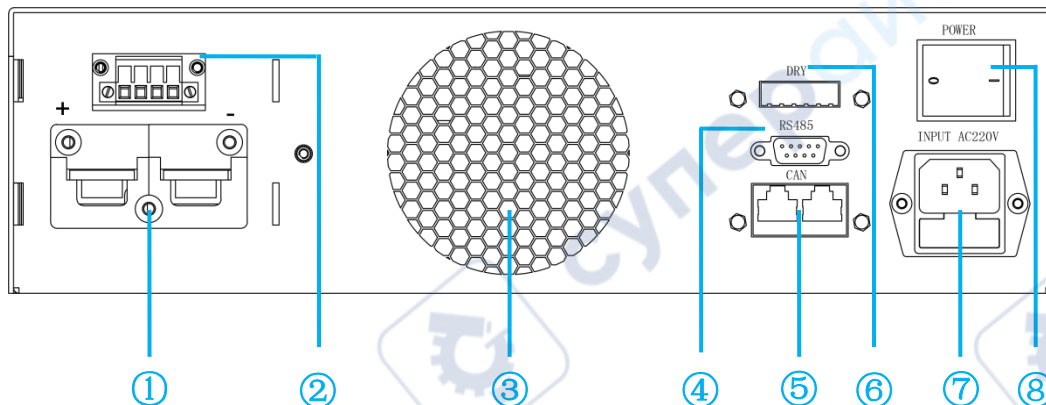

1kW model

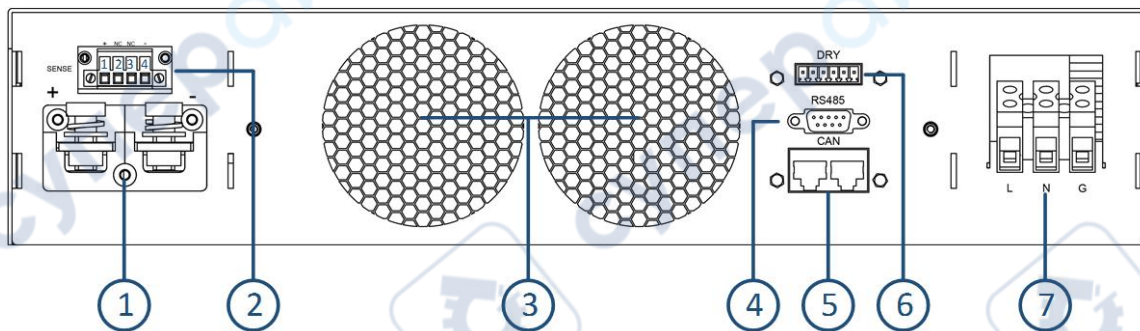

2kW & 3kW model

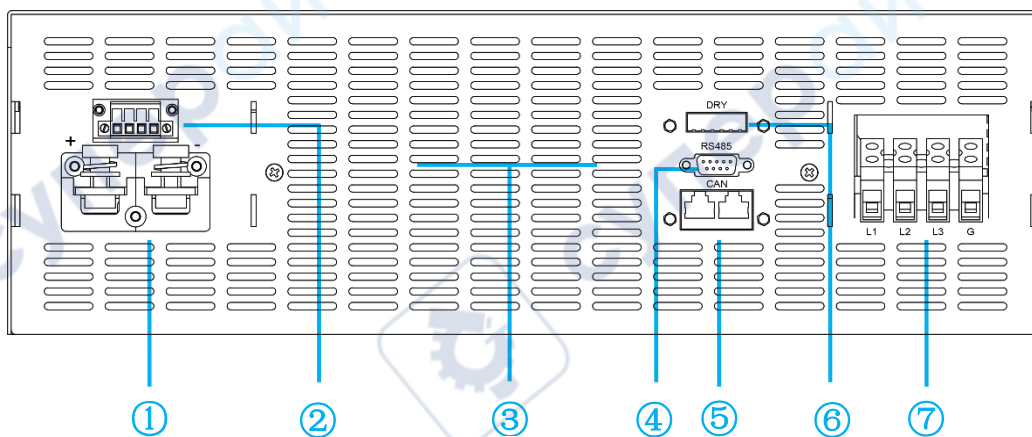

6kW & 8kW model

Figure 1: Back Panel

- |   |                                 |
|---|---------------------------------|
| 1. DC output terminal: RED "+", BLACK "-"     | 2. Remote voltage compensation  |
| 3. Duct outlet (No obstructions within 10 cm) | 4. RS485 interface(Female)      |
| 5. CAN interface                              | 6. Dry contact/Analog interface |
| 7. AC Input                                   | 8. switch                       |

# 1.1 Interface

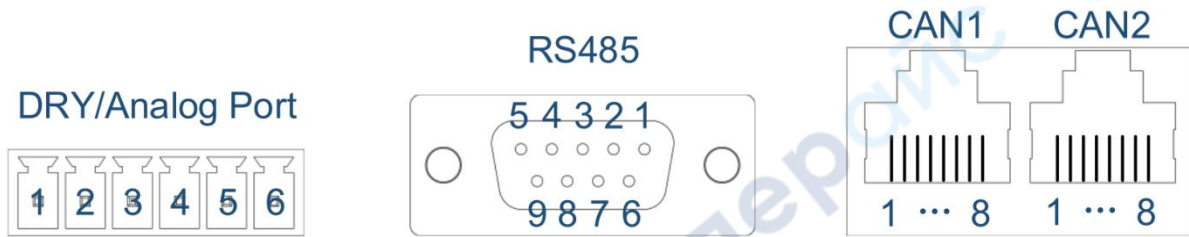

Figure 2: Interface

Interface	PIN	Function
Digital IO	1	Normally open contact (Output of the dry contact)
	2	Common contact (Output of the dry contact)
	3	Normally closed contact (Output of the dry contact)
	4	NC
	5	Input of the dry contact
	6	
RS485	1	485-A
	2	485-B
	3~9	NC
Analog	1	Matching analog1 “+”
	2	Matching analog1 “-”
	3	Matching analog1 “+”
	4	Matching analog1 “-”
	5	Input of the dry contact
	6	
CAN	2	CAN-L
	7	CAN-H
	1/3~6/8	NC

Table 1: Defines of interface

- Digital IO interface: PIN 1 to 3 is a dry contact output interface with complementary functions of normally open and normally close. PIN2 is the common port of the dry contact. Dry contact output capacity: 1A/30VDC or 0.15A/220VAC; PIN 5 to 6 are dry contact input interfaces, which can be set for external control of the output, external fault feedback, or external control of the buzzer;
- Analog interface: Analog interface is optional, interface signals can be customized, two analog interface definition as shown in the table above
- RS485 interface: Serial communication interface(female), software using standard Modbus-RTU protocol;
- CAN interface: CAN1 and CAN2 are two internal parallel CAN bus interfaces, which facilitate serial or parallel connection between devices. CAN communication also be used for communication between external devices;

**Note:** Analog interface is optional interface (customizable), up to a maximum of four analog, two analog input and two analog output. Select 1-2 analog, interface see figure above; select 3-4 analog, interface is RJ45-CAN1, 1-8 pin is defined as the positive and negative of analog input 1, the positive and negative of analog input 2, the positive and negative of analog output 1, the positive and negative of analog output 2. If you need analog function, please inform us of the specific requirements in advance.

## 1.2 Voltage compensation

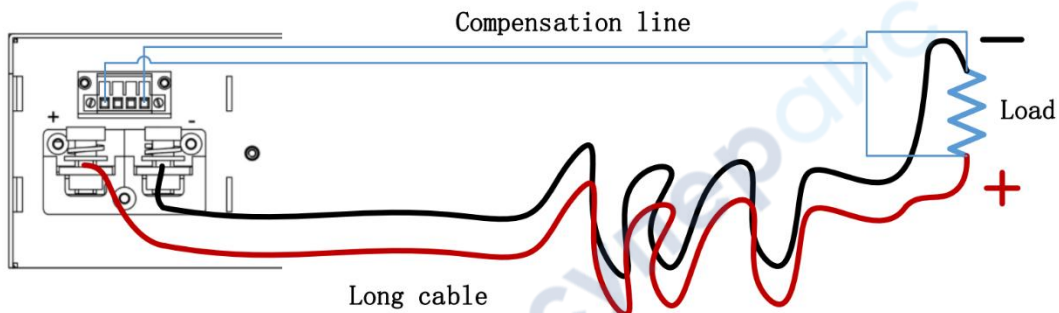

Figure 3: Schematic diagram of voltage compensation wiring

To use the remote voltage compensation function, use twisted-pair cables with high insulation. Positive and negative cables can not be connected inversely, as shown in the figure above. When not in use, the compensation terminals (SENSE) PIN1 and PIN2, and PIN3 and PIN4 need to be shorted with short cables.

## 1.3 Parallel connection

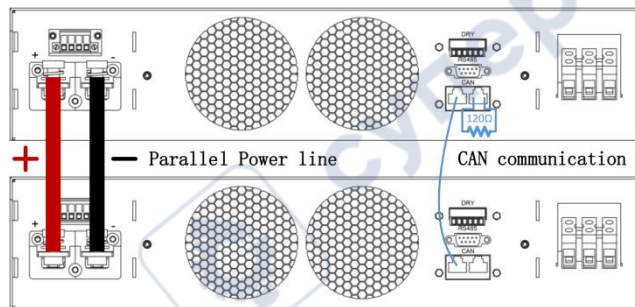

Figure 4: Parallel schematic diagram

The device identifies and controls the parallel output through CAN communication. The diagram above shows the parallel connection.

**Note:** 120 ohm is the CAN bus terminal resistor. The parallel function requires factory pairing and is an optional feature. If customers require this function, please note it in the order; otherwise, the default machine will not include parallel function capabilities or accessories. The parallel function is only applicable to models with 600V or below, and requires corresponding optional accessories, including positive and negative output connection cables (which may vary depending on current), Ethernet cables, and terminal resistors. Please note that the parallel function can only be used for parallel connection, not series connection.

## 2 Front panel

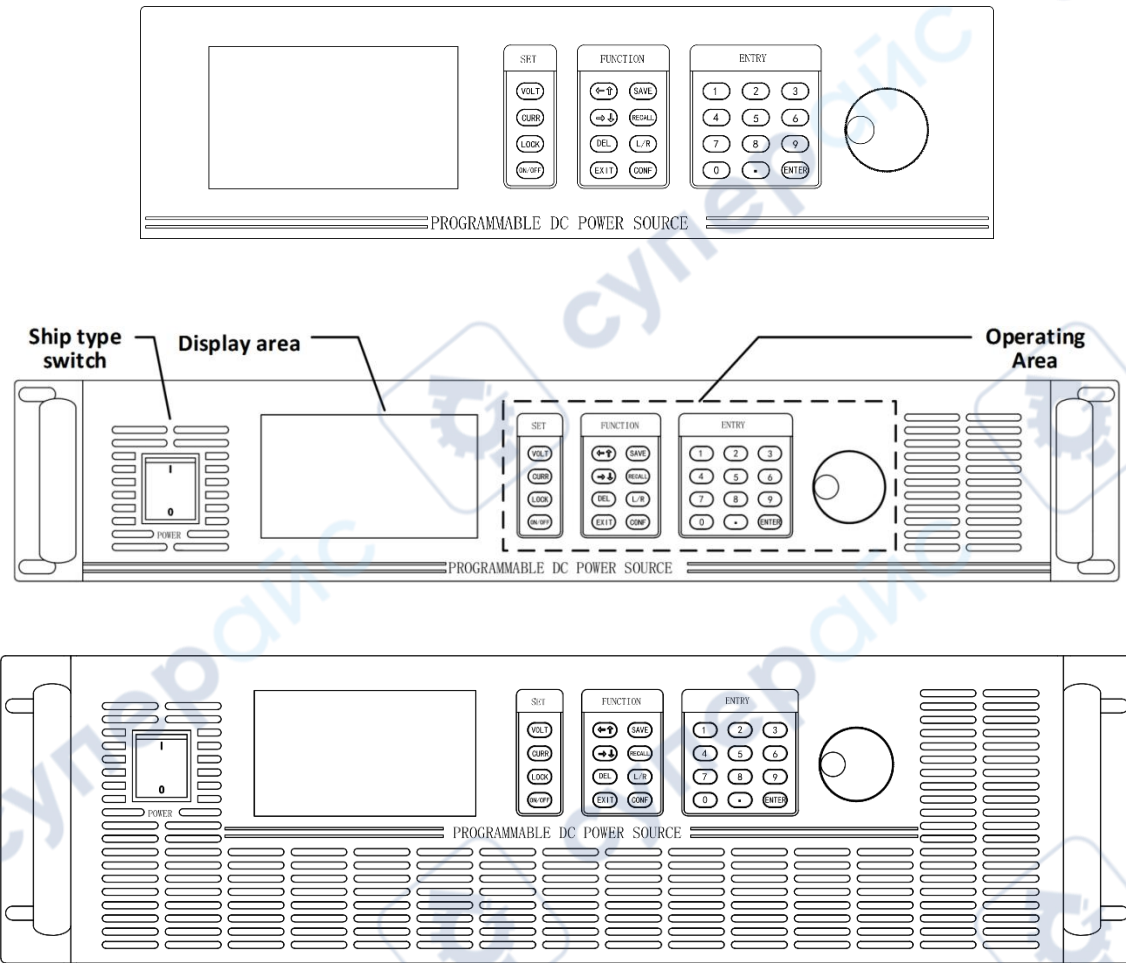

Figure 6: Front panel

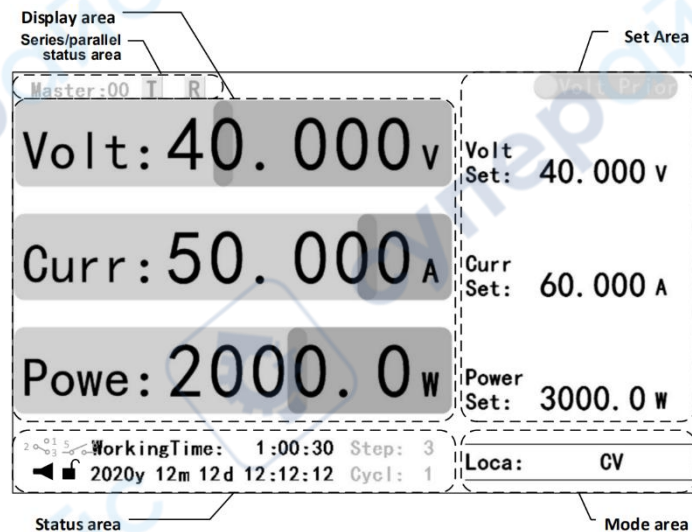

Figure 5: Display area

### 2.1 Display area

The Home displays real-time operating status information of the device, including:

- Display area: Current real-time output information;

- Setting area: Setting of voltage, current and power reference values, And voltage/current priority Settings;
- Status area: Buzzer, lock key state, date and time information, working time, and dry contact and application mode state (grey);
- Mode area: Control mode and output mode;
- Series/parallel status area: when multiple machines are used in series/parallel, each device will display master/slave machine number and CAN data receiving and receiving status of the machine (gray);

**Note:** 1. *display elements of the status area can be hidden. When an application mode is enabled, the status of the application mode will be displayed, and when the dry contact is used, the corresponding status icon will be displayed.*

2. *Output mode include common mode and application mode. 1. Common mode: CV(Constant voltage), CV(Constant current), CP(Constant power) or CV/CC/CP (Output is not open); 2. Application mode: such as CV Steps(Constant voltage steps), CC Steps(Constant current steps) and Hybrid steps in step mode(See the "Application Patterns" section for details).*

### 2.1.1 Home

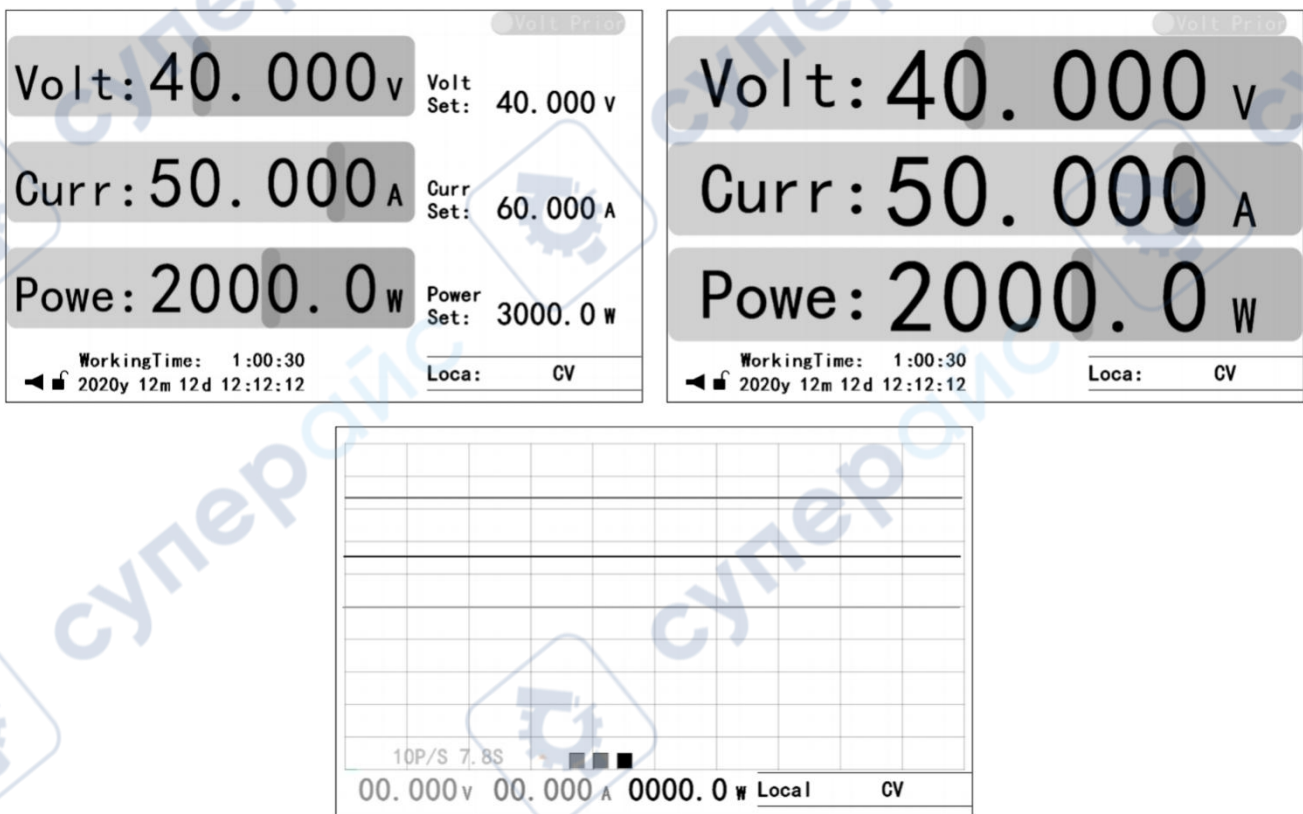

Figure 7: Homes

Three Homes, including:

- Home: displays the most comprehensive real-time working status information, detailed in the section of "Display area";
- Auxiliary Home: maximizes the real-time output information;
- Waveform Home: displays output real-time information in an intuitive waveform manner.

**Note: 1. The Home is the only interface for setting voltage, current and power reference values.**

**2. Press "ENTER" to set the sampling rate of the waveform displayed on the waveform Home. Whether the voltage, current and power waveform are displayed can be controlled by pressing "VOLT", "CURR" or "POWER" key.**

## 2.2 Operating area

Key	Description
VOLT	Voltage reference set
CURR	Current reference set
VOLT Double Click	Voltage priority switching
CURR Double Click	Current priority switching
VOLT+CURR	Power reference set
LOCK	Lock/Unlock
ON/OFF	Output ON/OFF
←↑	Left/Up shift
→↓	Right/Down shift
DEL	Delete
EXIT	Returns the previous level or exit setting
SAVE	Save current settings
RECALL	Recall the saved settings
L/R	local/remote control mode
CONF	Function Menu

Key	Description
0~9	Number set
.	DOT
ENTER	To Menu/ Confirm input Switch between Home and Auxiliary Home
Knob	Description
Press	Menu Confirm Input Home : 1、 Press once, Voltage set 2、 Press twice, Current set 3、 Press 3 times, Power set
Clockwise rotation	Increase value Up shift
Anti-Clock rotation	Reduce value Down shift

Table 2: Key description

The operation area includes setting area, function area, digital area and knob. See "Appendix 1" for key details.

### 2.2.1 Basic operation

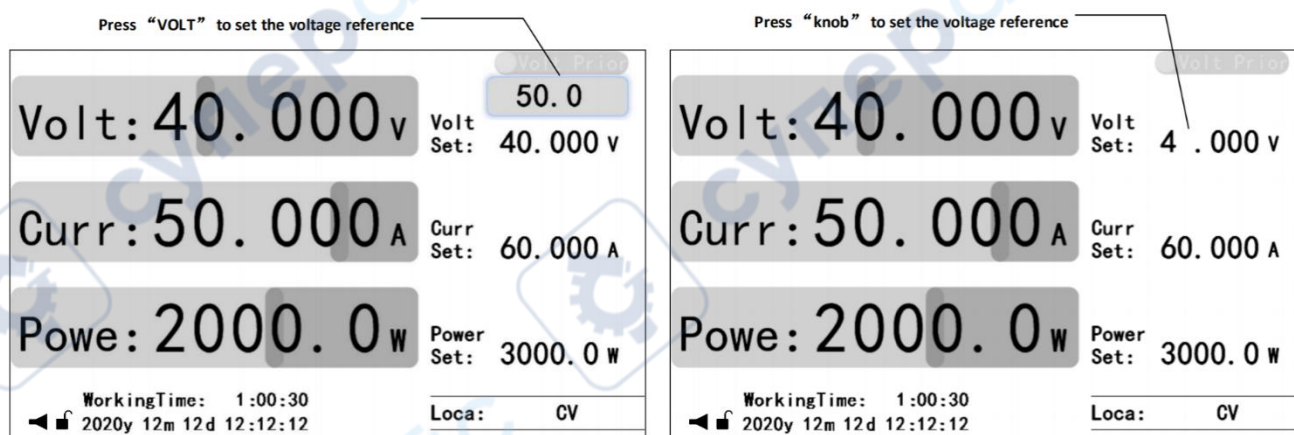

Figure 8: Reference setting

- Voltage reference setting: Press the "VOLT" key or press the "Knob" key to edit the voltage reference value, enter a valid value, and press "ENTER" or "knob" key to confirm;
- Current reference setting: Press the "CURR" key or press the "Knob" key twice to edit the current reference value, enter a valid value, and press "ENTER" or "knob" key to confirm;

- Power reference setting: Press "VOLT" and "CURR" key simultaneously or press "Knob" key three times to edit the power reference value, enter a valid value, and press "ENTER" or "knob" key to confirm;
- Open and close output: Press the "ON/OFF" key to open the output (The "ON/OFF" key is light), and press the "ON/OFF" key to close the output (The "ON/OFF" key is OFF);
- Voltage/current priority switching: Close the output and double-click "VOLT" or "CURR" key to switch the priority under the Home/auxiliary Home (Switch time is 1 seconds).
- SAVE Setting: 1. Under the Home, function setting UI or protection setting UI, if the Settings are valid, press "SAVE" key to save the common mode data; On the application mode setting UI, if the Settings are valid, press "SAVE" key to save the application mode data;
- Recall setting: 1. On the Home/auxiliary Home, press "RECALL" key to bring up the recall function option. Press "←↑" Or "→↓" key to select the data type and press "ENTER" key to go to the recall UI for the data type. Press "←↑" or "→↓" key to select the pre-called data and press "ENTER" key to confirm the callback data. 2. On the application mode setting UI, press "RECALL" key to bring up the relevant recall UI, press "←↑" or "→↓" key to select the pre-called data, and press "ENTER" key to confirm the callback data;
- Local/Remote mode switching: Press "L/R" to switch the local/remote mode temporarily in the Home/auxiliary Home(for temporary test, the mode is not saved).
- Buzzer control: Under the system setting UI, press "←↑" or "→↓" key to select Buzzer, and press "ENTER" key to enter buzzer control option. Select the corresponding level, and press "ENTER" key to confirm;

**Note: 1. Common mode data includes voltage, current and power reference values as well as parameters of function setting and protection setting in user Settings.**

**2. When the key triggers the setting of reference value, the preset area will be displayed above the corresponding operated element in the setting area. Enter a preset value through the number or knob key; When the knob triggers the setting of reference value, the corresponding bit of the element to be operated in the setting area will flash. Through "←↑" Or "→↓" key to select the operation position, and then enter the preset value through the number or knob key.**

**3. For local/remote mode Settings, see "LCD Menu - > User Settings - > Function setting " in section for details.**

# 3 Menu

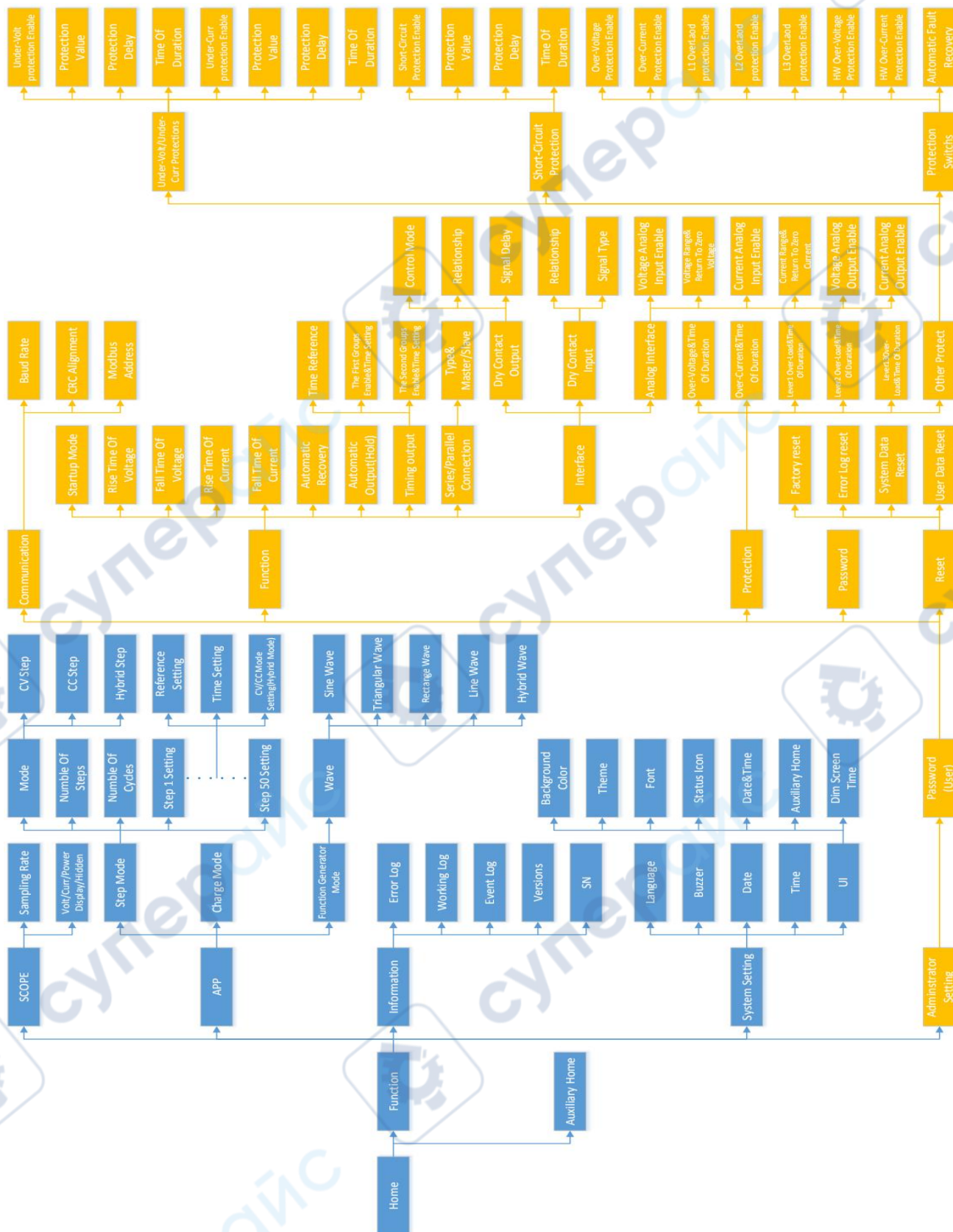

Figure 9: Menu

### 3.1 Application (APP)

1. Step Mode:	»
2. Charging Mode:	»
3. Function Generator Mode	»

Table 3: Application mode

Application modes include:

- Step mode: A sequence programming function that the device supports a maximum of 50 sequences. Users can edit each step of the function according to the actual needs, so that the device in a sequence of constant-voltage, constant-current mode output to meet the specific test needs;
- Charge mode: Applicable to charge and discharge aging test of different electric energy storage media such as lithium battery and capacitor. Set up a maximum of 10 charging sequences, each step can be independently set voltage/current reference value and judgment conditions to determine whether to enter the next step, can simulate fine charging curve;
- Function generator mode: This mode generates a variety of regular waveforms, such as sine, triangular, zigzagged, rectangular, pulse, trapezoidal and Line segment, and a combination of these waveforms and superpositions the modified waveforms onto the DC(Voltage or current) output. The preset function will provide all necessary parameters for the user, such as baseline, cycle number, waveform amplitude, time and so on a complete set of configuration parameters;

#### 3.1.1 Step Mode

Mode:	Hybrid Step	▼
Num Of Steps:	3	Steps
Num Of Cycles:	Infinite	
1: Step Setting:	XX.XXX V	CV ▼
Time Setting:	XXXXX	s
2: Step Setting:	XX.XXX V	CV ▼
Time Setting:	XXXXX	s
3: Step Setting:	XX.XXX V	CV ▼
Time Setting:	XXXXX	s
4: Step Setting:	-----	
Time Setting:	-----	

Table 4: Steps mode

Step mode parameters:

- Mode: Three mode options: Constant-voltage steps, constant-current steps and Hybrid steps. The above mode can set voltage reference and current reference and voltage or

current reference in a single step;

- Step number: The number of single step(range: 1 to 50) contained in a complete cycle;
- Cycle number: The number of loops that perform one full step at a time;
- Single-step setting: Each step outputs the contained the reference, duration, and mode selection content (The hybrid mode only);

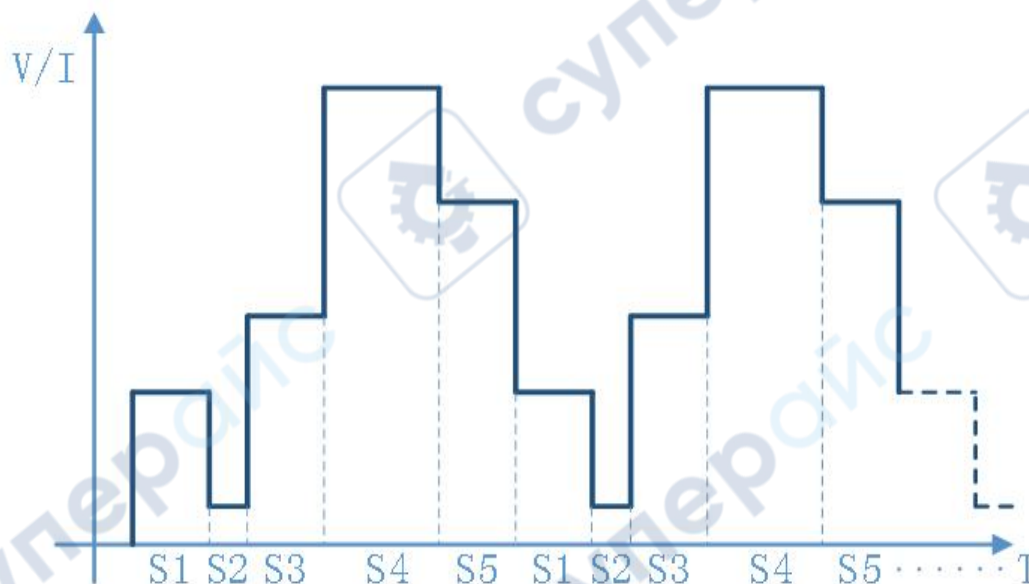

Figure 10: Step Mode

### 3.1.2 Charge Mode

Charging Mode:	Disable	▼
Num Of Steps:	3	Steps
Step Delay:	XXXXX	ms ▼
Dry Contact Control:	Disable	▼
Num Of Cycles:	Infinite	
Step1: Volt Reference:	XX.XXX	V
Curr Reference:	XX.XXX	A
Judgment Volt :	XX.XXX	V
Judgment Curr :	XX.XXX	A
Charging Curr :	XXXXX	s ▼
Charging Time :	XXXXX	s ▼

Table 5: Charge Mode

Charging mode parameters :

- Charging mode: Whether to enable charging mode;
- Step number: The number of single step(range: 1 to 10) contained in a complete cycle;
- Step delay: The delay that jumps to the next step after each step is completed;

- Dry contact control: Whether to enable the dry contact control function during discharge time.
- Cycle number: The number of loops that perform one full step at a time;
- Single-step setting: Each step outputs a control containing reference voltage/current, a judgment voltage/current setting, and a charge/discharge time setting;

**Note:** 1. *Each step of the execution logic: Reference voltage and current parameters control output ---> Detect the output voltage to reach the judgment voltage ---> The output current detected is less than the judgment current ---> Turn off the output, enter the charging period and time ---> At the end of the charging period, enter the discharge period and time, if dry contact control is enabled, dry contact action ---> When the discharge period ends, close the dry contact and go to the next step.*

2. *Charging time is the time from voltage and current judgment logic of each step to discharge time (float charging time).*

3. *Discharge time is the time from the completion of each charge time to the next step, during which the output will be closed. Generally used for external discharge of energy storage medium, can enable "Dry contact control" to control the switch between charging circuit and external discharge circuit.*

### 3.1.3 Function Generator Mode

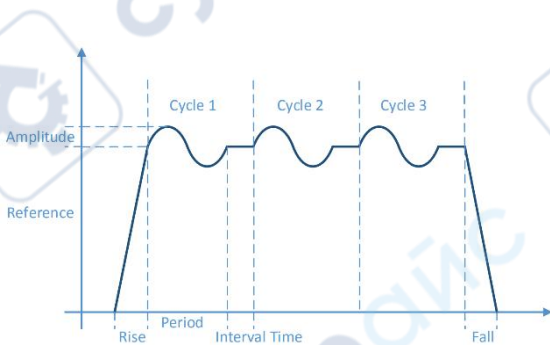

Wave:	Sine Wave	▼
Ref:	XX.XXX V	CV ▼
Periods:	Infinite	
Parameter Of Wave :		
Amplitude:	XX.XXX V	
Period :	XXXXX	s ▼
Interval Time :	XXXXX	s ▼

Table 6: Sine wave generator

Superimpose sine waves on the DC reference.

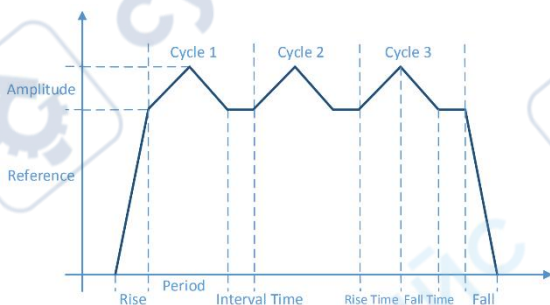

Wave:	TriangularWave	▼
Ref:	XX.XXX V	CV ▼
Periods:	Infinite	
Parameter Of Wave :		
Amplitude :	XX.XXX V	
Rise Time :	XXXXX	s ▼
Fall Time :	XXXXX	s ▼
Interval Time :	XXXXX	s ▼

Table 7: Triangle wave generator

Superimpose triangle or sawtooth waves on the DC reference.

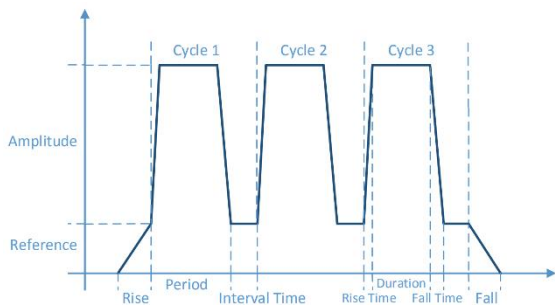

<b>Wave:</b>	Rectangle Wave	▼
<b>Ref:</b>	XX.XXX V	CV ▼
<b>Periods:</b>	Infinite	
<b>Parameter Of Wave :</b>		
<b>Amplitude :</b>	XX.XXX V	
<b>Rise Time :</b>	XXXXX	s ▼
<b>Duration :</b>	XXXXX	s ▼
<b>Fall Time :</b>	XXXXX	s ▼
<b>Interval Time :</b>	XXXXX	s ▼

Table 8: Rectangular/pulse/trapezoidal wave generator

Superimpose a rectangular, pulsed or trapezoidal wave on a DC reference.

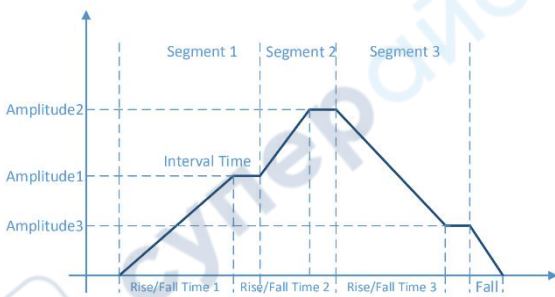

<b>Wave:</b>	Line Wave	▼
<b>Ref:</b>	CV	▼
<b>Periods:</b>	Infinite	
<b>Parameter Of Wave :</b>		
<b>Amplitude :</b>	XX Segments	
<b>Interval Time :</b>	XXXXX	s ▼
<b>Parameter Of Segments :</b>	>>	

Table 9: Line generator

Output line wave by multiple line segments.

## 3.2 Information

1. Error Log :	»
2. Working Log :	»
3. Event Log :	»
4. Version Of ARM :	V1.00.RL
5. Version Of HMI :	V1.00.RL
4. Version Of HW :	V1.00
7. SN :	WXXXXXXXXXXXXXXXXX

Table 10: Information

Information UI includes fault log, running log, event log, and product information.

### 3.2.1 Error Log

1 Error Log			
1.	Over Volt P	20 - 12 - 12	12 : 00 : 00
2.	Over Volt P	20 - 12 - 12	12 : 00 : 00

Table 11: Error log

When the device detects a fault, the fault is recorded and can be queried on the fault log page. Each fault information contains fault type, fault date, and fault time.

### 3.2.2 Operating Log

2 Records The Current Page : 0			
1.	Norm :	10kwh	Time : 20y 12m 12d 12h
1.	CvSt :	300wh	Time : 20y 12m12d 10h

Table 12: Operating log

The device automatically records each running information and you can query on the operating log page. Each operating information contains running mode information, output energy, and scrolling date, time, and time information in turn.

### 3.2.3 Event Log

2 Records The Current Page : 0			
1.	Sys : Init Flash	Close : 00.00V 00.000A	Time:
2.	Sys : Init Flash	Close : 00.00V 00.000A	Time:

Table 13: Event log

The device automatically records events and you can query them on the event log page. Each event information contains event type, event, event details, date, and time in turn.

### 3.3 System Setting

1. Language :	English	▼
2. Buzzer :	All	▼
3. Date :	20 y 12 m 12 d	
4. Time :	12 h 12 m 00 s	
5. UI :		»

Table 14: System setting

System setting UI includes language, buzzer, date, time, and UI parameters.

- Language: System language supports Chinese and English;
- Buzzer: The buzzer scales from bottom to high score according to the severity of the event: 1.All (including all events triggered by the key); 2.Faults and warnings; 3.Failure occurs; 4.mute;
- Date and time: System date and time Settings;

#### 3.3.1 UI Setting

1. Background Color :	Black	▼
2. Theme :	Bar	▼
3. Front :	Regular	▼
4. Status Icon :	Show	▼
5. Data & Time :	Show	▼
6. Auxiliary Home :	Show	▼
7. Dim Screen Time :	600 s	▼

Table 15: UI setting

UI setting parameters:

- Effect Settings: Background color, theme, and font options. When the theme is set as the progress bar, the voltage, current and power display bar will be displayed in proportion to the actual value and rated value;
- Element display: State icon (buzzer state and "LOCK" key state) and date and time display whether the element is displayed;
- Auxiliary Home: Under the Home, enter the auxiliary Home actively (Press "ENTER") or passively (Static wait 180 seconds);
- Dark screen time: Under static state, the LCD display darkens after a set time;

**Note: Static state means no manual operation of keys or knobs.**

### 3.4 User Setting

User settings menu includes five sub-menu: Communication Settings, Function Settings, Protection Settings, Password Settings, and Recovery Settings.

**Note:** You need a password to enter user setting menu. The default password is "12345678".

#### 3.4.1 Communication Setting

1. Baud Rate :	9600bps	▼
2. CRC Alignment :	Litt Endian	▼
3. Modbus Address :	0x01	

Table 16: Communication setting

Communication setting parameters:

- Baud rate: Supports five baud rates: 9600bps, 19200bps, 57600bps, 115200bps and 230400bps. The default is 9600bps;
- CRC alignment: THE CRC can be emitted as "small-endian" or "big-endian", with the default "small-endian";
- Modbus address: address range 1-247, default address is "1";

#### 3.4.2 Function Setting

1. Startup Mode :	Local	▼
2. Rise Time Of Volt :	XXXXX ms	▼
3. Fall Time Of Volt :	XXXXX ms	▼
4. Rise Time Of Curr :	XXXXX ms	▼
5. Fall Time Of Curr :	XXXXX ms	▼
6. Auto-Reco(Fault) :	30 s	▼ Close ▼
7. Auto-Output(Gold) :	30 s	Close ▼
8. Timing Output :		»
9. Parallel/Series Connection :		»
11. Interface Setting :		»

Table 17: Function setting

Function setting parameters:

- Startup mode: When the device switch is closed, the device is in local control or remote control mode;
- Rise/fall time of voltage: The slope of the voltage reference change, with options in milliseconds, seconds and minutes. This parameter takes effect only on voltage priority;
- Rise/fall time of current: The slope of the output current reference change, with options in milliseconds, seconds and minutes. This parameter takes effect only on Current priority;

- Automatic fault recovery: The output of the device is disconnected due to a recoverable fault. Whether to resume output after the fault is removed and the specified time passes. The unit option "second" and "minute";
- Auto-output(hold): The device is powered off during operation, if the auto-output was enabled, the device automatically restores to the last output state (ON/OFF) after the setting time;

**Note: 1. The rise time is the time required for output from 0 to the rated value, and the fall time is the opposite. As global parameters, rise and fall time are also applicable to the process of reference value establishment and output closing in APP mode.**

**2. Automatic fault recovery is enabled. If the recovery fails for 10 times within 10 minutes or 10 times of the set time, the device will not attempt to recover.**

**3. Auto-output (hold) function is generally used in unattended scenarios. When the power grid is off, the device will remember the output state before the power grid is off, and actively control the output after the program sets the time after the power grid recovers.**

### Timing Output:

1. Time Reference :	Clock ▼
The First Group :	Disable ▼
Power On Time :	08 h 00 m 00 s
Power Off Time :	10 h 00 m 00 s
The Second Group :	Disable ▼
Power On Time :	14 h 00 m 00 s
Power Off Time :	16 h 12 m 00 s

Table 18: Output timing setting

- Time Reference: Selects the clock or power-on time (switch off) as the time reference;
- Two groups time setting: Sets two groups of time parameters and sets whether the two groups of parameters are enabled respectively;

**Note: 1. Timing output function can not be used at the same time with the "ON/OFF" key. If you need to operate the "ON/OFF" key manually, you need to turn off the output timing function.**

**2. Timing output function does not take effect immediately. It takes effect after the next power on.**

## Parallel Connection:

1. Connection Type :	Parallel	▼
2. Master/Slave :	Slave	▼
Number Of Slaves:	1	▼

Table 19: Parallel connection

- Connection type: Type of device independent or parallel connection;
- Master-slave: When multiple devices are connected in parallel, one device is set up as the master device and the other devices as the slave device. The number of slaves in parallel needs to be set for the master;

## Interface Setting

1. Dry Contact Output :	»
2. Dry Contact Input :	»
3. Analog Interface :	»

Table 20: Interface Setting

## Dry Contact Output :

1. Control Mode :	Disable	▼
2. Relationship :	Error	▼
3. Signal Delay :	XXXXX ms	▼

Table 21: Dry contact output

- Control mode: The dry contact serves as the executive unit and the motion logic can be set to local or remote communication logic to control;
- Association logic: When control mode is set to "Local", the dry contact can be associated controlled by "Fault", "Power on/off", "Condition" or "time" logic;
- Signal delay: Dry contact action delay time;

**Note:** After the dry contact output function is enabled, the corresponding status of the dry contact is displayed on the Home and auxiliary Home.

## Dry Contact Input

1. Relationship :	Disable	▼
2. Signal Type :	Normally Open	▼

Table 22: Dry contact input

- Association logic: The input signal of a dry contact can be defined as an external fault, open/close output of a device, or buzzer control;
- Signal type: The signal type of the dry contact input (normally open or normally close);

**Note:** If the dry contact input function is enabled, the corresponding dry contact input status is displayed on the Home and auxiliary Home.

## Analog Interface

1. Voltage Analog Output:	Disable	▼
Control Range:	XX.XXX	V
Return To Zero Voltage:	XX.XXX	V
2. Current Analog Output:	Disable	▼
Control Range:	XX.XXX	A
Return To Zero Voltage:	XX.XXX	A
3. Voltage Analog Input:	Disable	▼
4. Current Analog Input:	Disable	▼

Table 23: Analog interface setting

The user can turn on or off the analog function separately.

Analog input parameters:

- Control Range: The actual output corresponding to the simulated quantity input (generally 0~10V);
- Return To Zero Voltage/Current: The return to zero voltage/current of the analog input;

**Note: The analog input/output function needs hardware support. If the analog interface circuit is not configured at delivery, the software will automatically skip the Settings related to it.**

### 3.4.3 Protect Setting

1. Over-Volt Value :	XX.XXX V
Time Of Duration :	XXX ms
2. Over-Curr Value :	XX.XXX V
Time Of Duration :	XXX ms
3. Level1 Overload Value :	XXXXX W
Time Of Duration :	XXX ms
4. Level2 Overload Value :	XXXXX W
Time Of Duration :	XXX ms
5. Level3 Overload Value :	XXXXX W
Time Of Duration :	XXX ms
6. Other Protect :	»

Table 24: Protect setting

Protection setting parameters:

- Protection value: Compared with the output value, when the output value is greater than the protection value, the protection enters the pre-triggered state;
- Duration: The time (0 to 60000mS) from when the protection enters the pre-triggered state to the time when the output is closed and alarm is reported (Fault occurs);

**Note: According to the severity, the overload protection can be set to three level protections.**

#### Other Protects :

1. Under-Volt/Under-Curr Protection :	»
2. Short-Circuit Protect :	»
3. Protection Switch :	»

Table 25: Other protects

Other protections include under-voltage protection, under-current protection, short-circuit protection, and protection switches. This type of protection is the opposite of the over-voltage/current protection mechanism, that is, when the output value is less than the protection value, the protection will enter the pre-triggered state. Short-circuit protection as same as under-voltage protection mechanism, the difference is that the short-circuit voltage is very small, sometimes close to "0" V, so short-circuit protection can be regarded as a special case of under-voltage protection.

1. Under-Volt Protection :	Disable ▼
Protection Value :	XX.XXX V
Protection Delay :	XXX ms
Time Of Duration :	XXX ms
2. Under-Curr Protection :	Disable ▼
Protection Value :	XX.XXX A
Protection Delay :	XXX ms
Time Of Duration :	XXX ms

Table 26: Under-voltage/under-current protection

Under-voltage/under-current protection parameters:

- Protection value: Compared with the output value, when the output value is less than the protection value, the protection enters the pre-triggered state;
- Protection delay: The time when the output stabilizes (slow rise ends) to effect the protection function;
- Duration: The time after the guard enters the pre-triggered state to close the output and alarm (Fault occurs);

**Note: 1. When the output is started, the voltage/current can be stabilized to the reference value after a short time (response time) or a slow rise time. The under-voltage and under-current protection mechanism will come into effect after the reference value is stabilized.**

**2. During the duration, if the output value returns to normal, the program will exit the pre-triggered state and start monitoring the output again.**

1. Short-Circuit Protection :	Disable	▼
Protection Value :	XX.XXX	V
Protection Delay :	XXX	ms
Time Of Duration :	XXX	ms

Table 27: Short-circuit protect

Short-circuit protection parameters:

- Protection value: Compared with the output value, when the output value is less than the protection value, the protection enters the pre-triggered state;
- Protection delay: The time when the output is opened to effect the protection function.
- Duration: The time after the guard enters the pre-triggered state to close the output and alarm (fault occurrence);

**Note: 1. As the voltage/current output behaves differently under different load conditions, the short-circuit protection parameters should be set according to the specific application.**

**2. short-circuit fault may occur in the process of slow rise, and under-voltage and under-current protection delay is different, short circuit protection mechanism began to play a role in the open output.**

**3. During the duration, if the output value returns to normal, the program will exit the pre-triggered state and start monitoring the output again.**

## Protection Switches :

1. Over-Volt Protection :	Enable	▼
2. Over-Curr Protection :	Enable	▼
3. L1 Overload Protection :	Enable	▼
3. L2 Overload Protection :	Enable	▼
3. L3 Overload Protection :	Enable	▼
6. HW Over-Volt Protection :	Enable	▼
7. HW Over-Volt Protection :	Enable	▼
8. Automatic Failover P :	Enable	▼

Table 28: Switch of protects

Enable or disable protection functions.

### 3.4.4 Password Setting

User settings require password access, users can reset the password as required.

**Note:** *The password consists of eight digits. The default password is "12345678".*

### 3.4.5 Reset

1. Factory Reset :	NO	▼
2. Error Log Reset :	NO	▼
3. System Data Reset :	NO	▼
4. User Data Reset :	NO	▼

Table 29: Reset

Recovery setting can reset/clear a certain type of data.

**Note:** *Factory Reset: reset data except running records and event records.*

*User Data Reset: Reset some or all of the data such as communication Settings and function Settings to factory Settings.*

# 4 Technical Specifications

## 4.1 Product parameters

Technical Data	1kW	2kW	3kW	6kW	8kW
<b>AC:Supply</b>					
- Voltage	1 $\Phi$ 220VAC $\pm$ 10%			3 $\Phi$ 380VAC $\pm$ 10%	
- Frequency	50/60Hz				
<b>DC:Voltage</b>					
- Accuracy	< 0.1% of rated value			V < 1000V : < 0.1% of rated value V $\geq$ 1000V : < 0.2% of rated value	
- Load regulation 1-100%	< 0.05% of rated value				
- Line regulation $\pm$ 10% $\Delta$ U <sub>AC</sub>	< 0.05% of rated value				
- Regulation 10-100% load	< 5ms				
- Slew rate 10-90%	< 20ms-60s			V < 1000V : < 20ms-60s V $\geq$ 1000V : < 100ms-60s	
- Voltage compensation	< 5% rated voltage			V < 1000V : < 5% rated voltage V $\geq$ 1000V : < 5V	
- Ripple	< 0.1% of rated value			V < 1000V : < 0.1% of rated value V $\geq$ 1000V : < 0.3% of rated value	
<b>DC:Current</b>					
- Accuracy	< 0.15% of rated value			V < 1000V : < 0.15% of rated value V $\geq$ 1000V : < 0.5% of rated value	
- Load regulation 1-100%	< 0.1% of rated value				
- Line regulation $\pm$ 10% $\Delta$ U <sub>AC</sub>	< 0.05% of rated value				
<b>-DC:Power</b>					
- Accuracy	< 0.3% of rated value			V < 1000V : < 0.3% of rated value V $\geq$ 1000V : < 0.7% of rated value	
<b>Protection</b>					
	Over voltage protection, over current protection, over load protection, over temperature protection and so on				
<b>Insulation</b>					
- AC input to enclosure	1500VDC				
- AC input to DC output	1500VDC				
- DC output to enclosure (PE) enclosure (PE)	2000VDC				
<b>Other</b>					
- Digital interfaces	CAN, RS485				
- Dry contact input	Dry contact input				
- Dry contact output	Dry contact output				
- Cooling	Air cooling				
- Operation temperature	-5 °C-45 °C				
- Storage temperature	-20 °C -60 °C				

- Humidity	< 80%, No condensation			
- Dimensions (W H D)	325*88*450mm	425*88*450mm	425*132*551.5mm	
- Weight	9KG	11KG	14KG	25KG

## 4.2 Product selection

Power	Model	Voltage	Current	Interface
1KW	OWP1006H	60.000V	30.000A	CAN、RS485、Dry Node/Analog
	OWP1010H	100.00V	15.000A	CAN、RS485、Dry Node/Analog
	OWP1020H	200.00V	8.0000A	CAN、RS485、Dry Node/Analog
	OWP1030H	300.00V	5.0000A	CAN、RS485、Dry Node/Analog
2KW	OWP2004H	45.000V	100.00A	CAN、RS485、Dry Node/Analog
	OWP2006H	60.000V	80.000A	CAN、RS485、Dry Node/Analog
	OWP2008H	80.000V	60.000A	CAN、RS485、Dry Node/Analog
	OWP2010H	100.00V	45.000A	CAN、RS485、Dry Node/Analog
	OWP2015H	150.00V	30.000A	CAN、RS485、Dry Node/Analog
	OWP2020H	200.00V	23.000A	CAN、RS485、Dry Node/Analog
	OWP2030H	300.00V	15.000A	CAN、RS485、Dry Node/Analog
	OWP2040H	400.00V	12.000A	CAN、RS485、Dry Node/Analog
	OWP2050H	500.00V	9.0000A	CAN、RS485、Dry Node/Analog
	OWP2060H	600.00V	8.0000A	CAN、RS485、Dry Node/Analog
3KW	OWP3004H	45.000V	100.00A	CAN、RS485、Dry Node/Analog
	OWP3006H	60.000V	80.000A	CAN、RS485、Dry Node/Analog
	OWP3008H	80.000V	60.000A	CAN、RS485、Dry Node/Analog
	OWP3010H	100.00V	45.000A	CAN、RS485、Dry Node/Analog
	OWP3015H	150.00V	30.000A	CAN、RS485、Dry Node/Analog
	OWP3020H	200.00V	23.000A	CAN、RS485、Dry Node/Analog
	OWP3030H	300.00V	15.000A	CAN、RS485、Dry Node/Analog
	OWP3040H	400.00V	12.000A	CAN、RS485、Dry Node/Analog
OWP3050H	500.00V	9.0000A	CAN、RS485、Dry Node/Analog	

	OWP3060H	600.00V	8.0000A	CAN、RS485、Dry Node/Analog
6KW	OWP6010H	100.00V	100.00A	CAN、RS485、Dry Node/Analog
	OWP6015H	150.00V	67.000A	CAN、RS485、Dry Node/Analog
	OWP6020H	200.00V	50.000A	CAN、RS485、Dry Node/Analog
	OWP6025H	250.00V	40.000A	CAN、RS485、Dry Node/Analog
	OWP6030H	300.00V	34.000A	CAN、RS485、Dry Node/Analog
	OWP6040H	400.00V	25.000A	CAN、RS485、Dry Node/Analog
	OWP6050H	500.00V	20.000A	CAN、RS485、Dry Node/Analog
	OWP6060H	600.00V	17.000A	CAN、RS485、Dry Node/Analog
	OWP6100H	1000.0V	10.000A	CAN、RS485、Dry Node/Analog
	OWP6150H	1500.0V	4.0000A	CAN、RS485、Dry Node/Analog
	8KW	OWP8010H	100.00V	100.00A
OWP8015H		150.00V	67.000A	CAN、RS485、Dry Node/Analog
OWP8020H		200.00V	50.000A	CAN、RS485、Dry Node/Analog
OWP8025H		250.00V	40.000A	CAN、RS485、Dry Node/Analog
OWP8030H		300.00V	34.000A	CAN、RS485、Dry Node/Analog
OWP8040H		400.00V	25.000A	CAN、RS485、Dry Node/Analog
OWP8050H		500.00V	20.000A	CAN、RS485、Dry Node/Analog
OWP8060H		600.00V	17.000A	CAN、RS485、Dry Node/Analog
7.5KW	OWP8100H	1000.0V	10.000A	CAN、RS485、Dry Node/Analog
	OWP8150H	1500.0V	5.0000A	CAN、RS485、Dry Node/Analog

**Note: the above specifications are subject to update without notice**

# 5 Appendix

## 5.1 Accessory

Certificate×1

Quick guide×1

1.5m input power line×1

6PIN terminal block×1

Complete set of parallel connection cables ×1 (optional)

## 5.2 Key description

Area	Abbreviation	Description
Setting	VOLT	Voltage reference setting
	CURR	Current reference setting
	VOLT+CURR	Power reference setting
	LOCK	Lock/unlock key
	ON/OFF	Open/close output
Function	← ↑	Move the cursor one bit to the left (numeric Settings) Move up one line
	→ ↓	Move the cursor one bit to the right (numeric Settings) Move down one line
	DEL	Deletes the value of the current bit
	EXIT	Return to the previous level or exit the setting
	SAVE	Save the normal data (In normal mode) Save App data (In data mode)
	RECALL	Recall saved data on Home
	L/R	Switch local/remote mode
	CONF	Enter the function UI
Figure	0~9	Enter figure
	.	Enter decimal point "."
	ENTER	Enter the menu Input confirm Switch the home and the Auxiliary home
Knob	Clockwise	Increment the input value (numeric Settings) Move Up N line
	Anticlockwise	Decrease the input value (numeric Settings)

		Move Down N line
	Press	Enter the menu Input confirm Under the home: <ol style="list-style-type: none"><li>1. Press to set voltage reference</li><li>2. Press twice to set the current reference</li><li>3. Press three times to set the power reference</li><li>4. In the reference setting state, press confirm</li></ol>

## 5.3 User setting list

Scope	Name	Description	Default
Communication	Baud Rate	Baud rate setting	9600 bps
	CRC Alignment	Sending mode of CRC 16-bit check data	Little Endian
	Modbus Address	Modbus protocol address	0x01
Function	Startup Mode	The device is in local/remote control mode after power on	Local
	Rise Time Of Voltage	Rise Time Of Voltage Setting	30 ms
	Fall Time Of Voltage	Fall Time Of Voltage Setting	0 ms
	Rise Time Of Current	Rise Time Of Current Setting	30 ms
	Fall Time Of Current	Fall Time Of Current Setting	0 ms
	Auto-Reco(Fault)	After the fault occurs, disable the output and check whether the output will be automatically restored after the specified time	30 S, Close
	Auto-output(Hold)	After power-on, whether to automatically start output after the specified time	30 S, Close
	Timing output	Reference time: Use the clock or power-on time as the reference time Time range Enable: Enables or disables this time range On/Off time: set the time range	Disable
	Parallel/Series Connection	Type of connection: independent, parallel or series Master/slave: the master or slave	Independent
	Dry Contact output	Control mode: Disable, local or remote control Relationship: logic related to fault, startup, condition setting, or time setting Signal delay: delay from the dry contact action after the logic is triggered	Disable
Dry Contact Input	Relationship: Disabled; Fault; Start or buzzer	Disable	
Protection	Over-Volt Value	Over-Voltage Protection Value	105% $V_{Rated}$
	Time of Duration	Trigger over-voltage protection time	1000 ms
	Over-Curr Value	Over-Current Protection Value	105% $I_{Rated}$
	Time of Duration	Trigger over-current protection time	500 ms
	Level1 Overload Value	Level1 overload protection value	105% $P_{Rated}$
	Time of Duration	Trigger Level1 overload protection time	10000 ms
	Level2 Overload Value	Level2 overload protection value	110% $P_{Rated}$

	Time of Duration	Trigger Level2 overload protection time	5000 ms
	Level3 Overload Value	Level3 overload protection value	120% P <sub>Rated</sub>
	Time of Duration	Trigger Level3 overload protection time	1000 ms
	Under-Volt Protection	Under-voltage protection switch	Disable
	Protection Value	Under-voltage protection value	10% V <sub>Rated</sub>
	Protection Delay	Under-voltage protection detection delay	1000 ms
	Time Of Duration	Trigger under-voltage protection time	1500 ms
	Under-Curr Protection	Under-current protection switch	Disable
	Protection Value	Under- current protection value	10% I <sub>Rated</sub>
	Protection Delay	Under- current protection detection delay	1000 ms
	Time Of Duration	Trigger under- current protection time	1500 ms
	Short-Circuit Protection	Short-circuit protection switch	Disable
	Protection Value	Short-circuit protection voltage value	5% V <sub>Rated</sub>
	Protection Delay	Short-circuit protection detection delay	10 ms
	Time Of Duration	Trigger Short-circuit protection time	20 ms
	Protection Switchs	Relevant protection switches	---
Password	Password	User Default Settings	---
Reset	Factory Reset	Restoring factory Settings (except for information records)	---
	Error Log reset	Clears fault Records	---
	System Data Reset	Clears UI or all system setting	---
	User Data Reset	Clears selected data	---

## 5.4 Warning list

Name	Attribute	Description	Troubleshooting
Write EEPROM Err	Unrecoverable error	Write EEPROM Error	Power off, Restart.
Read EEPROM Err		Read EEPROM Error	Power off, Restart.
Write FLASH Err		Write FLASH Error	Power off, Restart.
Read FLASH Err		Read FLASH Error	Power off, Restart.
Diff Speci Err		Different from Master specifications	Power off, Restart.
External Error	Recoverable error	A fault was detected through dry contact input	Check whether dry contact signal input is normal and exclude alarm signal.
Driver Protect		Driver circuit error	Power off, Restart.
HW Over-Volt P		The hardware over-voltage circuit detects an over-voltage error	Confirm start overshoot or steady overshoot (overshoot in working process), if it is start overshoot, can set "priority" to "current priority", can also set "Rise Time Of Volt"

			parameter to a reasonable value(voltage priority); If it is a steady state overshoot and the voltage is not more than 1.3 times the rated voltage, you can turn off the hardware overvoltage protection function. If the voltage is more than 1.3 times the rated voltage, install an anti-reverse diode on the output side.
HW Over-Curr P		The hardware over-current circuit detects an over-current Error	Confirm start overshoot or steady overshoot (overshoot in working process), if it is start overshoot, can set "priority" to "voltage priority", can also set "Rise Time Of Volt" parameter to a reasonable value(voltage priority); If steady-state overshoot occurs, disable hardware overcurrent Protection.
Over-Volt P		The software detects an over-voltage error	Confirm start overshoot or steady overshoot (overshoot in working process), if it is start overshoot, can set priority to "voltage priority", can also set "Rise Time" parameter to a reasonable value; If the overshoot is steady state, the "over-current protection value" or "overcurrent duration" can be appropriately increased;
Over-Curr P		The software detects an over-current error	Confirm start overshoot or steady overshoot (overshoot in working process), if it is start overshoot, can set "priority" to "voltage priority", can also set "Rise Time Of Curr" parameter to a reasonable value(current priority); In the case of steady overshoot, the "overcurrent protection value" or "overcurrent duration" can be appropriately raised.
Under-Volt P		The software detects an under-voltage error	Check whether the error is reasonable. If not, reset under-voltage protection parameters.
Under-Curr P		The software detects an under-current error	Check whether the error is reasonable. If not, reset under-current protection parameters.
Short-Circuit P		The software detects an short-circuit error	Check whether the short-circuit protection occurs. If the short-circuit error occurs, rectify the short-circuit error. Otherwise, reset the short-circuit protection parameters.
Over-Load P		The software detects an overload error	Eliminate overload error or adjust overload protection parameters.
Over Temperature		The software detects an over- Temperature error	Check whether the power supply air duct is blocked.

Error Resume		Automatic error recovery is enabled, recoverable errors are detected, and recovery attempts fail for 10 times	After confirming the cause of the error and troubleshooting, restart the machine. The error alarm can be cleared by pressing the "EXIT" key on the main UI.
key is locked	Warning	Key locked	Press the "LOCK" key to unlock it.
Return to HOME		Operation method in the home	Return to the main UI and operate.
Close Output		Method of operation in closed output state	Operation after closing output.
RemoteCntr:Comms		Operate keys in remote mode	Press "L/R" to switch back to local control.
RemoteCntr:Analog			
Switching Prior		Cannot start output during priority switching	Open output later.
Please Later!		The priority cannot be switched again during priority switching	Wait 1 second and switch the priority again.
Step Mode Is En		Cannot enable other mode in step mode	Operation after Turn off Step mode.
Chg Mode Is En		Cannot enable other mode in charge mode	Turn off charging mode before operation.
Func Mode Is En		Cannot Enable other mode In function generator mode	Turn off function generator before operation.
Exit Setting		Illegal operation	Operation after exiting the Settings.
Invalid Operate		The save and call functions are unavailable in the current UI	Perform operations on the correct UI.
Value Exceeds		The input value exceeds the legal range	Input valid value.
Value Too Small			
Not Be Set To '0'		The input value cannot be '0'	Input valid value.
Password Error		Incorrect password input	Input the correct password, if you forget the password, call our company.
Unset Volt Ref	The output cannot be open without setting the voltage reference	Set the voltage reference and start the output.	
Unset Curr Ref	The output cannot be open without setting	Set the current reference and start the output.	

		the current reference	
Unset Power Ref		The output cannot be open without setting the power reference	Set the power reference and start the output.
Illegal Data		Saving a data group is invalid	Save the data group after setting it correctly.
Full Data Space		128 data groups are full	Delete redundant data groups and save them.
No Dada		The precall data group is empty	Call data after saving the corresponding data group.
AddrRange :1~247		Invalid MODBUS address	Input valid address
Func Code Err	Communication error	Invalid function code	Operate according to the communication protocol;
RegisterAddrErr		Invalid register address	Operate according to the communication protocol;
Data Range Err		Illegal data	Operate according to the communication protocol;
Local Mode Err		The device is in local control mode	Switch to remote mode