

Function/Arbitrary waveform signal generator

Programmable

Model: PSG9080

User Manual



PSG9080 dual channel function/arbitrary waveform signal generator

User Manual

Rev1.0 June 2020

Guaranty and Declaration

Copyright

Hangzhou Junce Instruments Co., Ltd. all right reserved.

Trademark Information

JUNTEK is a registered trademark of Hangzhou Junce Instruments Co., Ltd.

Notices

JUNTEK products are covered by P.R.C. patents, issued and pending.
This document replaces all previously published documentation.

Contact Us

If you have any problem or requirement when using our products or this manual, please contact JUNTEK.

E-mail: junce@junteks.com

Website: www.junteks.com

Safety Requirement

General Safety Summary

Please review the following safety precautions carefully before putting the instrument into operation so as to avoid any personal injury or damage to the instrument and any product connected to it. To prevent potential hazards, please follow the instructions specified in this manual to use the instrument properly.

Use Proper Power Cord

Only the exclusive power cord designed for the instrument and authorized for use within the local country could be used.

Connect the Probe Correctly

If a probe is used, do not connect the ground lead to high voltage since it has isobaric potential as the ground.

Observe All Terminal Ratings

To avoid fire or shock hazard, observe all ratings and markers on the instrument and check your manual for more information about ratings before connecting the instrument.

Use Proper Over-voltage Protection

Ensure that no over-voltage (such as that caused by a bolt of lightning) can reach the product. Otherwise, the operator might be exposed to the danger of an electric shock.

Do Not Operate Without Covers

Do not operate the instrument with covers or panels removed.

Do Not Insert Anything Into the Air Outlet

Do not insert anything into the air outlet to avoid damage to the instrument.

Avoid Circuit or Wire Exposure

Do not touch exposed junctions and components when the unit is powered on.

Do Not Operate With Suspected Failures

If you suspect that any damage may occur to the instrument, have it inspected by JUNTEK authorized personnel before further operations. Any maintenance, adjustment or replacement especially to circuits or accessories must be performed by JUNTEK authorized personnel.

Provide Adequate Ventilation

Inadequate ventilation may cause an increase of temperature in the instrument, which would cause damage to the instrument. So please keep the instrument well ventilated and inspect the air outlet and the fan regularly.

Do Not Operate in Wet Conditions

To avoid short circuit inside the instrument or electric shock, never operate the instrument in a humid environment.

Do Not Operate in an Explosive Atmosphere

To avoid personal injuries or damage to the instrument, never operate the instrument in an explosive atmosphere.

Keep Instrument Surfaces Clean and Dry

To avoid dust or moisture from affecting the performance of the instrument, keep the surfaces of the instrument clean and dry.

Prevent Electrostatic Impact

Operate the instrument in an electrostatic discharge protective environment to avoid damage induced by static discharges. Always ground both the internal and external conductors of cables to release static before making connections.

Handle with Caution

Please handle with care during transportation to avoid damage to keys, knobs, interfaces, and other parts on the panels.

Notices

1. Make sure that the input power is correct.
2. The shell of the instrument is fragile and easy to corrode. Please don't hit or close to chemicals to avoid corrosion.
3. Working temperature: 10~ 50°C, storage temperature : 20 ~70°C, and keep the instrument in a dry environment.
4. Do not attempt to disassemble the instrument, it will void the warranty. There are no user-serviceable parts inside the instrument. Repairs can only be made through designated repair outlets or sent back to the factory.
5. Please avoid placing unsafe items such as lighted candles, cups with water, and corrosive chemicals on the surface of the instrument to avoid damage to the instrument.
6. The display screen is a fragile device, please do not touch or bump it . Please avoid children playing with the instrument. When there is dirt on the LCD surface, wipe it carefully with a soft cloth.
7. Please do not move the instrument violently to avoid causing irreparable damage to the internal circuit. If the instrument does not work properly, please contact the supplier!

Contents

Guaranty and Declaration.....	I
Safety Requirement.....	II
General Safety Summary.....	II
Notices.....	III
Contents.....	IV
Inspection.....	4
Chapter I PSG9080 Overview.....	2
1.The Instrument Introduction.....	2
2.Dimension.....	2
3.Specifications.....	3
Chapter II Instrument Introduction.....	10
1.Front Panel Overview.....	10
2.Rear Panel Overview.....	13
3.Display Interface.....	15
Chapter III Basic Operations Of the Instrument.....	17
1.Power On and Inspection.....	17
2.To Output Basic Waveform.....	17
3.Modulation Mode Interface and Parameter Settings.....	19
4.Parameters Setting of Measurement Mode Interface.....	28
5.Parameters Setting of Frequency Sweep Mode Interface.....	30
6.Parameters Setting of Voltage Control Mode Interface.....	31
7.Parameters Setting of Programming Mode Interface.....	33
8.System Settings.....	35
9.PC Software Control Output.....	37
Troubleshooting.....	40
For More Product Information.....	41
Warranty.....	41

Inspection

When you get a new PSG9080 programmable signal generator, it is recommended that you inspect the instrument according to the following steps.

Inspect the Packaging

If the packaging has been damaged, do not dispose the damaged packaging or cushioning materials until the shipment has been checked for completeness and has passed both electrical and mechanical tests. The consigner or carrier shall be liable for the damage to the instrument resulting from shipment. We would not be responsible for free maintenance/rework or replacement of the instrument.

Check the Contents

Please check the contents according to the packing lists. If the instruments are damaged or incomplete, please contact your JUNTEK sales representative.

Host	PSG9080 programmable function/arbitrary waveform signal generator	1pc
Accessory	Power cable	1pc
	USB cable	1pc
	BNC to alligator clips test lead	1pc
	BNC male plug test lead	1pc
	Certificate of conformity	1pc
	Quick start	1pc

Inspect the Instrument

In case of any mechanical damage, missing parts, or failure in passing the electrical and mechanical tests, contact your JUNTEK sales representative.

Chapter I PSG9080 Overview

1.The Instrument Introduction

PSG9080 programmable dual channel function/arbitrary waveform signal generator can generate various waveforms such as sine wave, square wave, triangle wave, pulse wave, and arbitrary wave. The frequency range of the instrument is from 1nHz to 80MHz, and it has the functions of modulation, frequency sweep, measurement signal frequency and programming, etc. It can display the output signal, amplitude, phase, duty and frequency at the same time. The instrument has excellent amplitude-frequency characteristics, multi-functions, high performance, high cost performance, portable and other characteristics providing a new choice for education, research and development, production, testing and other industries.

The appearance of this instrument is exquisite and beautiful, and it is equipped with a 3.5-inch high-resolution color LCD screen to bring you a brand new visual experience.

2.Dimension

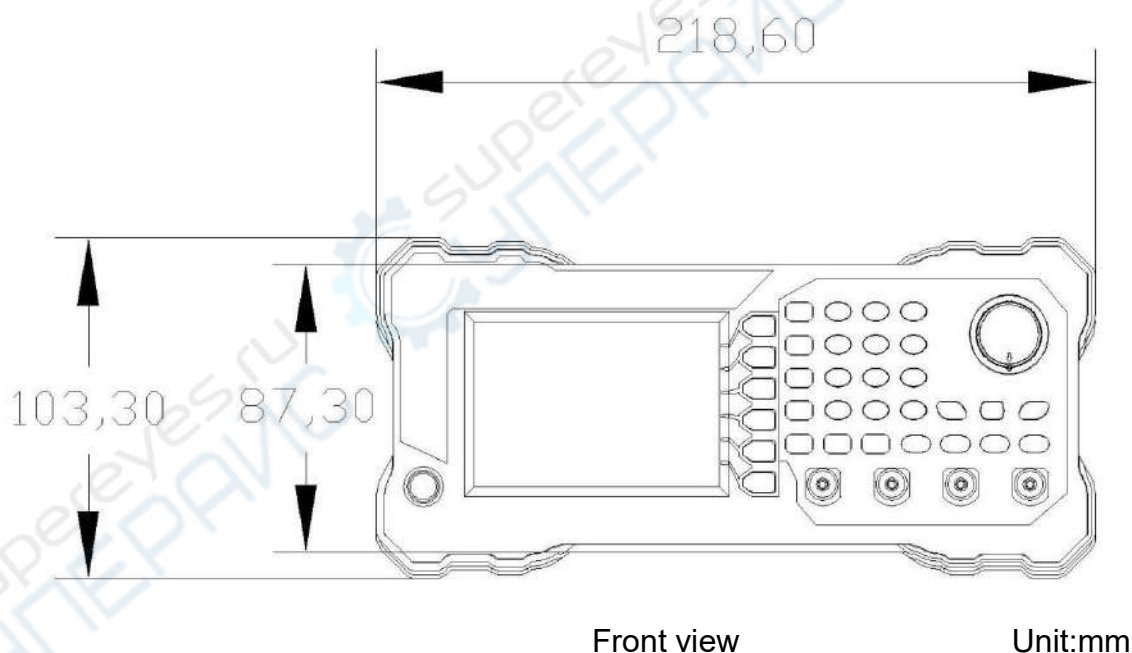

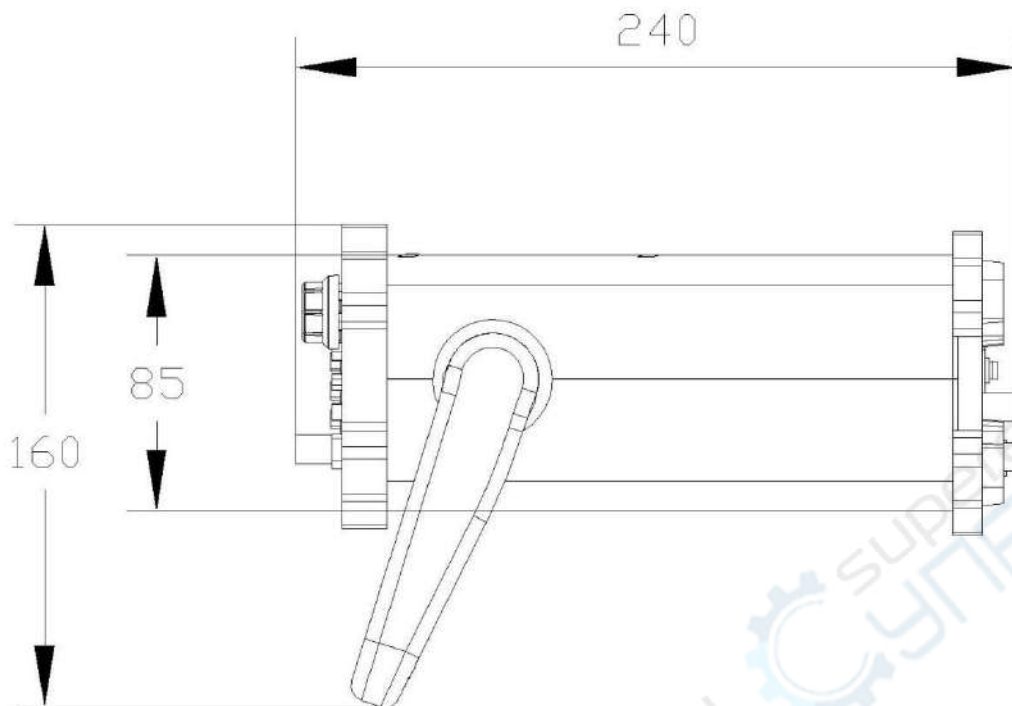

Side view

Unit:mm

3.Specifications

Model	PSG9080
Channel	2
Sine wave frequency range	1nHz-80MHz
Sampling Rate	300MSa/S
Waveform characteristics	
Wave length	8192 points/channel
Waveform vertical resolution	14 bits
Basic waveform	Sine,square,pulse,ramp,CMOS,DC,partial sine and noise wave
Built-in waveform	Sine,square,pulse,triangle,ramp,CMOS,DC level,partial sine,half,full, positive step wave, inverse step wave, noise,exponential rise, exponential fall,logarithm ascending,logarithmic descending, sinker pulse, multi-tone ,lorenz

Frequency characteristics	
Sine wave frequency range	1nHz-80MHz
Square wave frequency range	1nHz-30MHz
Triangle wave frequency range	1nHz-50MHz
Pulse wave frequency range	1nHz-30MHz
TTL digital wave frequency range	1nHz-20MHz
Arbitrary wave frequency range	1nHz-50MHz
Pulse width adjustment range	5nS~4S
Pulse period adjustment range	10nS~40S
Frequency minimum resolution	1nHz
Frequency accuracy	±5ppm 0 to 50℃
Frequency stability	±3ppm per 1 year
Sine wave spectrum purity	
Total harmonic distortion	≤0.5% (@1kHz,5Vpp)
Signal characteristics	
Square wave	
Rise/Fall Time	≤10nS
Overshoot	≤10%
Non-symmetry	≤0.1%
Ramp and triangle wave	
Non-linearity	≤1%(Less than 1MHz)
Non-symmetry	≤1%(Less than 1MHz)
Pulse wave	
Pulse Width	5nS~4S
Pulse period	10nS~40S
Duty cycle	0.01%-99.99%
Leading/Trailing Edge Time	≤10nS
Overshoot	≤10%
Arbitrary wave	

Wave length	8192 points (8K points)
Vertical resolution	14 bits
Minimum rise/fall time	≤10nS
Overshoot	≤10%
Arbitrary waveform non-volatile storage number	99

Output characteristics	
Amplitude	
Amplitude range	Frequency≤1MHz; 2mVpp~25Vpp 1MHz≤Frequency<11MHz; 2mVpp~10Vpp 11MHz≤Frequency<60MHz; 2mVpp~5Vpp 60MHz≤Frequency<80MHz; 2mVpp~3.6Vpp
Amplitude resolution	1mVpp
Amplitude stability	± 1% ±1 mVpp (@ 1 kHz,>10 mVpp)
Amplitude flatness	±1%(0.1dB)<10MHz ; ±2%(0.2dB)<10MHz~50MHz ±10%(0.9dB)<50MHz~70MHz; ±20%(1.9dB)<70MHz~80MHz
DC Offset	
Range	-9.99V-15.00V
Resolution	0.01V
Phase characteristics	
Adjustment range	0°-359.99°
Resolution	0.01
Waveform output	
Impedance	50Ω (typical)
Protection	Short-circuit protection
Modulation characteristics	
Modulation type	AM、FM、PM、ASK、FSK、PSK、PWM、BURST
AM	
Carrier waveform	Sine, square, ramp, arbitrary (except DC)
Source	Internal/External

Modulating waveform	Sine, square, ramp, noise, arbitrary
Depth	0% to 200%
Modulating frequency	1mHz to 1MHz
FM	
Carrier waveform	Sine, square, ramp, arbitrary (except DC)
Source	Internal/External
Modulating waveform	Sine wave, square wave, ramp wave, noise wave, arbitrary wave
Modulating frequency	1mHz to 1MHz
Frequency deviation	0.1Hz to 10kHz
PM	
Carrier waveform	Sine, square, ramp, arbitrary (except DC)
Source	Internal/External
Modulating waveform	Sine, square, ramp, arbitrary (except DC)
Phase deviation	0° to 360°
Modulating frequency	1mHz to 1MHz
ASK	
Carrier waveform	Sine, square, ramp, arbitrary (except DC)
Source	Internal/External
Polarity	Positive and negative
Rate	1mHz to 1MHz
ASK amplitude	0% to 200%
FSK	
Carrier waveform	Sine, square, ramp, arbitrary (except DC)
Source	Internal/External
Modulating waveform	Pluse wave with 50% duty cycle
Polarity	Positive and negative
Rate	1mHz to 1MHz
Frequency hopping	0.1Hz to 80MHz
PSK	
Carrier waveform	Sine, square, ramp, arbitrary (except DC)

Modulating waveform	Internal/External
Polarity	Positive and negative
Rate	1mHz to 1MHz
PSK phase	0° to 360°
PWM	
Carrier waveform	Pulse
Wave inversion	Regular and reverse
Pulse period	0.01uS to 40S
Pulse Width	0.001uS to 4S
Burst	
Idle	Zero position, positive maximum, negative maximum
Mode	Single, automatic
Trigger source	Manual t, CH2 burst, external (AC), external (DC)
Pulse number	1-1000000000

Measurement and counter function	
Measurement mode	
Measurement function	Frequency, positive/negative pulse width, period, duty cycle
Coupling method	DC, AC
Gate time	0.001S-10.000S
Measurement mode	Low frequency, high frequency
Frequency measurement range	1Hz~100MHz
Input signal amplitude range	2Vpp~20Vpp
Period measurement	10nS~4S
Pulse Width	4S
Duty cycle measurement range	0.01%~99.99%
Counter mode	
Range	0-4294967295

Coupling method	DC and AC
Counting method	Manual
External modulation input characteristics	
Input signal amplitude range	0~3Vpp
Input signal frequency range	DC~20kHz
Sweep characteristics	
Sweep channel	CH1 or CH2
Carrier waveform	Sine, square, ramp, arbitrary (except DC)
Sweep function	Sweep frequency, sweep amplitude, sweep duty
Sweep mode	Linear, logarithmic
Sweep direction	Increment, decrement, round trip
Start/end frequency	Consistent with the upper and lower limits of the corresponding carrier frequency
Start/end amplitude	Consistent with the upper and lower limits of the corresponding carrier amplitude
Start/end duty cycle	Consistent with the upper and lower limits of the corresponding carrier duty cycle
Sweep time	0.01S-640S
Voltage control characteristics	
Voltage control channel	CH1 or CH2
Carrier wave	Sine wave, square wave, ramp wave, arbitrary wave (except DC)
Voltage control function	Frequency control, amplitude control, and duty cycle control
Sweep mode	Linear, logarithmic
Start/end frequency	Consistent with the upper and lower limits of the corresponding carrier frequency
Start/end amplitude	Consistent with the upper and lower limits of the corresponding carrier amplitude
Start/end duty cycle	Consistent with the upper and lower limits of the corresponding carrier duty cycle
Voltage control voltage range	0V-5V, starting point and end point can be set arbitrarily

Programming features		
Running mode	Debugging、 normal	
Storage	P00-P19	
Programming number	00-99	
Programming time	Single serial number programming time 0-99S	
General parameters		
Display		
Screen	3.5 inch TFT color LCD screen	
Resolution	320*480	
Color	64K true color	
Store and load		
Quantity	100 groups	
Location	00 to 99 (The data of 00 storage location is loaded by default)	
Interface		
Interface method	USB to serial interface	
Extension interface	Serial port with TTL level, convenient for secondary development	
Communication rate	Standard 115200BPS	
Protocol	Using the command line, the protocol is open.	
Power		
AC power	Supply voltage	85V-264V, 47-63Hz
	Power consumption	Less than 30W
	Fuse	250VAC,T3.15A
DC power	Voltage/current	DC5V±0.5V 3A
Environment		
Temperature	0~40℃	
Humidity	Humidity:<80%	

Chapter II Instrument Introduction

1. Front Panel Overview



Figure 2-1-1 PSG9080 front panel

Table 2-1-1 PSG9080 front panel diagram instructions

Label	Introduction	Label	Introduction
①	Power key	⑥	Knob
②	Signal input connectors	⑦	Numeric keyboards
③	Signal output connectors	⑧	Function keys
④	Channel control area	⑨	Menu softkeys
⑤	Direction keys	⑩	LCD

① Power Key

The power key is used to turn the generator on or off.

② Signal Input Connectors

- EXT.IN signal input connector
Input signal voltage range 2Vpp~20Vpp.
- MOD.IN modulation input connector
Input signal voltage range 0Vpp~3Vpp.

③ Signal Output Connectors

- CH1 output connector
BNC connector with $50\Omega \pm 10\%$ nominal output impedance.

When CH1 is enabled (the backlight turns on), this connector outputs waveform according to the current configuration of CH1.

➤ CH2 output connector

BNC connector with $50\Omega \pm 10\%$ nominal output impedance.

When CH2 is enabled (the backlight turns on), this connector outputs waveform according to the current configuration of CH2.

④ Channel Control Area

➤ CH1 key

It is used to control the output of CH1.

Press this key to open the output of CH1, the backlight turns on and the CH1 connector outputs the waveform according to the current configuration of CH1.

Press this key again to close the output of CH1 and the backlight turns off.

➤ CH2 key

It is used to control the output of CH2.

Press this key to open the output of CH2, the backlight turns on and the CH2 connector outputs the waveform according to the current configuration of CH2.

Press this key again to close the output of CH2 and the backlight turns off.

➤ OUT key

It is used to control the output switches of CH1 and CH2.

⑤ Direction Keys

Used to move the cursor to select the digit to be edited when setting parameter.

Used to delete the number at the left of the cursor when inputting parameter using numeric keyboard.

⑥ Knob

Used to increase (clockwise) or decrease (counterclockwise) the value marked by the cursor when setting parameter using knob.

Used to quickly switch waveforms when the waveform bar is activated.

⑦ Numeric Keyboard

It consists of numeric keys (0 to 9), decimal point (.) and sign key (+/-) to set parameters.

⑧ Function Keys

➤ SYS Key

Used to quickly switch between system setting interface and main interface.

Press the **【SYS】** key to enter the system setting interface, press the **【PgDn】** soft key to enter the next page of the system setting interface, and

press the ▲ ▼ soft keys to select clear storage, sound, brightness, language, built-in wave number, arbitrary wave number, waveform loading method, synchronization, factory reset, system color and other items.

Press **【SHIFT】** + **【SYS】** keys to quickly enter the system help function.

➤ MOD Key

Used to quickly switch between the modulation mode interface and the main interface.

Press the **【MOD】** key to enter the modulation mode. In the modulation mode interface, press the **【Type】** soft key to switch between amplitude modulation, frequency hopping, phase modulation, key amplitude, key frequency, key phase, pulse, and burst functions.

Press **【SHIFT】** + **【MOD】** keys to enter burst function quickly.

➤ MEAS Key

Used to quickly switch between the measurement mode interface and the main interface.

Press the **【MEAS】** key and press the **【CNTR.】** and **【MEAS.】** soft keys in the measurement mode interface to switch between the measurement function and the counting function.

Press the **【SHIFT】** + **【MEAS】** keys to quickly enter the counting mode.

➤ LOAD Key

Used to quickly load the parameters of the storage location.

Press the numeric keys to enter the position to be loaded, and then press the **【LOAD】** key to quickly load the parameters of that stored position.

Press **【SHIFT】** + **【LOAD】** keys to save parameters quickly.

➤ SHIFT Key

Accessibility key.

Press **【SHIFT】** + **【SYS】** keys to quickly enter the system help function.

Press **【SHIFT】** + **【MOD】** keys to quickly enter burst function .

Press **【SHIFT】** + **【MEAS】** keys to quickly enter counting mode.

Press the numeric keys + **【SHIFT】** + **【LOAD】** keys to quickly save the parameters to the corresponding storage location.

➤ SWEEP Key

Used to quickly switch between the sweep mode interface and the main interface.

Press the **【SWEEP】** key to enter the sweep frequency interface, and press the **【FUNC】** soft key to switch between sweep frequency, sweep amplitude and sweep duty functions.

➤ VOC Key

Used to quickly switch between the voltage control mode interface and the main interface.

Press the **【VOC】** key to enter the voltage control frequency interface, and press the **【FUNC】** soft key to switch between the frequency control, amplitude control, and duty control functions.

➤ FUNC Key

Used to quickly switch between the programming mode interface and the main interface.

Press the **【FUNC】** key to enter the programming mode interface, and press the **【FUNC】** soft key to switch between the normal mode and the modulation mode.

➤ **【🏠】** Key

Press the **【🏠】** key to restore the default interface.

Press the **【🏠】** key and hold it to save the data to the M00 position quickly.

⑨ **Function Softkey**

Corresponding to the menu on the left, press softkeys to activate the corresponding menu.

⑩ **LCD**

3.5 inches TFT (480×320) color LCD display. The current function menu, parameter settings and etc. can be clearly displayed.

2.Rear Panel Overview

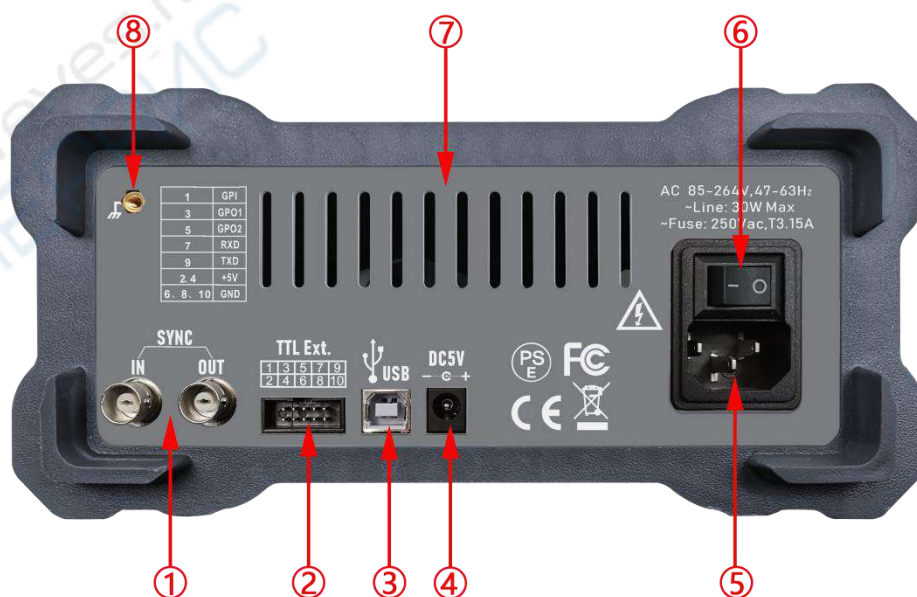

Figure 2-2-1 PSG9080 rear panel

Figure 2-2-1 PSG9080 rear panel diagram instructions

Label	Instructions	Label	Instructions
①	Sync ports	⑤	AC power socket
②	Extension port	⑥	Switch
③	USB interface	⑦	Cooling holes
④	DC power socket	⑧	Chassis Ground

① Sync Ports

Through this ports, the phases of the output signals of different signal generators can be synchronized.

② Communication Extension Port: TTL Digital Signal Output and Measurement Interface

The serial port with TTL level mode is convenient for users' secondary development.

1	GPI	Digital signal input interface
3	GPO1	Digital signal output interface 1
5	GPO2	Digital signal output interface 2
7	RXD	Serial communication RXD receive data
9	TXD	Serial communication TXD send data
2、4	+5V	VCC
6、8、10	GND	GND

③ USB Interface

Used to connect the generator to a computer which can control the generator remotely using PC software or by programming.

④ DC Power Socket

Voltage and current specifications DC5V±0.5V 3A

⑤ AC Power Socket

The AC power supply specification of this signal generator is 85-264V, 47-63Hz. The maximum input power of the instrument cannot exceed 30W. The specification of the fuse is 250V, T3.15A.

⑥ Switch

Used to turn the signal generator on or off.

⑦ Cooling Holes

Used to dissipate the heat generated inside the instrument.

⑧ **Chassis Ground**

Used to connect with the ground to prevent personal electric shock and ensure the normal operation of the electrical system.

3. Display Interface

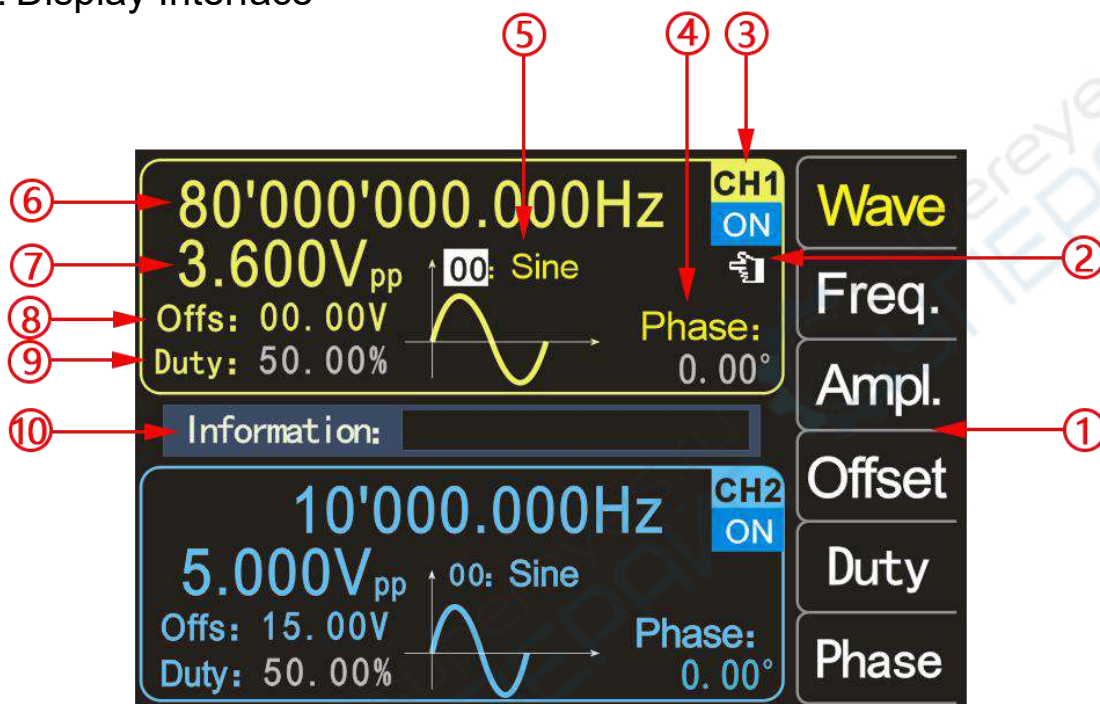

Figure 2-3-1 PSG9080 display interface

Table 2-3-1 PSG9080 display interface diagram instructions

Label	Instructions	Label	Instructions
①	Soft key menu	⑥	Frequency
②	Finger cursor	⑦	Amplitude
③	Current channel status	⑧	Offset
④	Phase	⑨	Duty cycle
⑤	Waveform display	⑩	Information box

① **Soft Key Menu**

Display the operation menu of the function (interface) selected currently.

② **Finger Cursor**

The current finger cursor is on the CH1 interface, indicating that the current state is the selected CH1 channel, and changing parameters is only valid for the CH1 channel.

After pressing the **【CH2】** key, the finger cursor can move to the CH2 interface, indicating that the current state is the selected CH2 channel, and changing the parameters is only valid for the CH2 channel.

③ Current Channel Status

Indicating the selected status and on/off status of the current channels. “ON” indicates that the channel output is on, and “OFF” indicates that the channel output is off.

In the main interface, press **【OUT】** keys to control the output status of CH1 and CH2 at the same time.

Note: Both channels can be turned on simultaneously, but cannot be selected at the same time.

④ Phase

Display the phase of the current waveform. After pressing the corresponding **【FUNC】** soft key, use the direction keys to change the digit and the knob to modify the parameter.

⑤ Waveform Display

Display the waveform currently in the main channel.

⑥ Frequency

Press **【Freq.】** to highlight “Frequency” and use the direction keys to select the digit to be edited, and then rotate the knob to modify the value, or you can also modify the value by inputting the value and then pressing the corresponding unit soft key. Press the **【Freq.】** soft key twice, the corresponding frequency unit (MHz, kHz, Hz, MHz, μ Hz) will appear, and press the corresponding function software to select the unit.

⑦ Amplitude

Display the waveform amplitude of the current channel. Press **【Ampl.】** to highlight “Amplitude” and use the direction keys to change the digit and knob to modify this parameter. You can also modify the value by inputting it and then pressing the corresponding unit softkey. The amplitude unit (Vpp, MVpp).

⑧ Offset

Display the waveform DC offset of the current channel. Press **【Offset】** to highlight “Offset” and use the direction keys to change the digit and knob to modify this parameter. You can also modify the value by inputting it and then pressing the corresponding unit soft key. The offset unit (V) .

⑨ Duty Cycle

Display the waveform duty cycle of the channel. Press **【Duty】** to highlight “Duty” and use direction keys to change the digit and knob to modify this

parameter. You can also modify the value by inputting it and then pressing the corresponding unit soft key. The duty cycle unit (V) .

⑩ **Information Box**

Display the value entered and position of saved and loaded.

Chapter III Basic Operations Of the Instrument

1. Power On and Inspection

To Connect to Power

Please connect the generator to AC power supply using the power cord supplied in the accessories for power supply. The AC power supply input specification of this generator is AC85-264V, 47-63Hz. DC5V ± 0.5V 3A power adapter can also be used for power supply.

Power-on

After the power supply is correctly connected, press the power key at the front panel to turn on the generator. During the start-up, the instrument executes initialization and self-test. After that, the default interface is displayed. If the instrument does not start normally, please refer to the introduction in “Troubleshooting”.

To Set the System Language

After entering the boot interface, you can press the corresponding soft key to select the desired system language. You don't need to select the language when you turn it on again, the main interface can be directly entered.



Boot interface



Language selection interface

2. To Output Basic Waveform

PSG9080 function/arbitrary waveform generator can output basic waveforms (Sine wave, square wave, triangle wave and pulse wave) from one of the channels separately or from the two channels at the same time. At start-up, the dual channels are configured to output a sine waveform with 10kHz frequency and 5Vpp amplitude by default. Users can configure the instrument to output various basic waveforms.

Output basic waveforms video:

http://68.168.132.244/PSG9080SCJBBX_EN.mp4

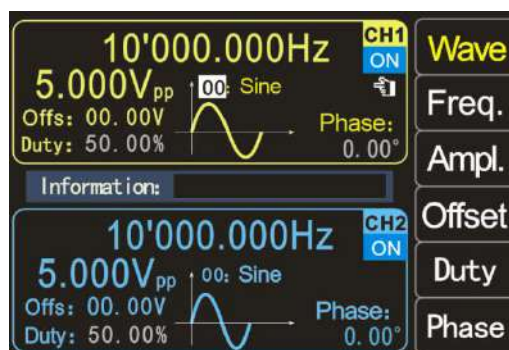

Figure 3-2-1 Waveform interface

To Select the Output Channel

Press the channel control key **【CH1】** to select the CH1 channel. At this time, the finger cursor on the right of the CH1 interface on the screen will be on.

Press **【CH2】** to select CH2. At this time, the finger cursor on the right side of the CH2 interface will be on.

To Select Basic Waveforms

Press the **【Wave】** soft key. The soft key menu bar on the right side of the screen displays the waveform. Press the desired waveform soft key or use the knob to change the waveforms to output the desired waveform.

To Set the Frequency

Press **【Freq.】** soft key to highlight “Frequency”, at this time, use the numeric keyboard to input the value of the desired frequency, and then select the desired unit from the pop-up unit menu. You can also use the directions keys and knob to set the value of the parameter: use the direction keys to move the cursor to select the digit to be edited, and then turn the knob to modify the value to adjust the frequency to the desired frequency; the frequency range is 0~80MHz.

Press **【Freq.】** soft key again to select the frequency unit: MHz, KHz, Hz, mHz, μ Hz.

To Set the Amplitude

Press the **【Ampl.】** soft key to highlight the “Amplitude” and enter it through the numeric keyboard or turn the knob to set the desired amplitude value.

The amplitude range is limited by the frequency setting. The higher the frequency, the smaller the output amplitude range. For details, see the output characteristics of the **“Specifications”** in the above table.

To Set the Offset

Press the **【Offset】** soft key to highlight “Offset” and use the direction keys and the knob or numeric keyboard to adjust the parameters to set the offset to

the desired value.

The amplitude range is affected by the offset setting, the larger the offset, the smaller the amplitude range. When the DC level is selected for the waveform, the offset is the voltage value of the DC level (the amplitude value cannot be 0). For details, refer to the DC offset characteristics of the "Specifications" table above.

To Set the Duty Cycle

The duty cycle cannot be adjusted with a sine wave, and the duty cycle is displayed in gray on the screen.

Press the **【Duty】** soft key to highlight the "Duty Cycle" and use the direction keys and the knob or numeric keyboard to adjust the parameters. The default duty cycle is 50%. The waveform is switched to pulse wave, and the duty cycle is 0.01-99.99% continuously adjustable.

To Set the Phase

Press **【CH2】** to select CH2. At this time, the finger cursor on the right of the CH2 interface on the screen will be on.

On the CH2 interface, press the **【Phase】** soft key to highlight "Phase", and use the arrow keys and the knob or numeric keyboard to adjust the parameters. The phase difference is 0.00° by default. Before setting the phase difference, please set CH1 and CH2 frequency synchronization in the system settings.

In the state of frequency synchronization, the phase of CH1 can be adjusted.

To Observe the Output Waveforms

Use the BNC test lead to connect CH1 and CH2 of the PSG9080 to the oscilloscope. Observe the waveforms of the oscilloscope. It is recommended to use our standard BNC male plug test lead to test the square wave, so that the overshoot is small and the waveform is stable.

Load and Save Parameters

Press the **【↑】** key and hold it to quickly save the parameters to the M00 position, or you can enter the saved position through the numeric keys and then press the **【SHIFT】** + **【LOAD】** keys to save, a total of 100 storage locations 00-99.

Enter the desired position by pressing the numeric keys, and then press the **【LOAD】** key to load the parameters of the storage position.

3.Modulation Mode Interface and Parameter Settings

The PSG9080 can output modulated waveforms in single or dual channels. Modulation is the process of processing the information of the signal source and adding it to the carrier to make it suitable for channel transmission.

It is the technology that changes the carrier with the signal. Carrier wave can be sine wave, square wave, pulse wave, arbitrary wave (except DC signal wave). The modulated wave can come from an internal modulation source or an external modulation source. The modulation types supported by PSG9080 include AM, FM, PM, ASK, PSK, FSK, pulse and burst. The modulation interface is shown as Figure 3-3-1.

Modulation function description video:

http://68.168.132.244/PSG9080TZGN_EN.mp4

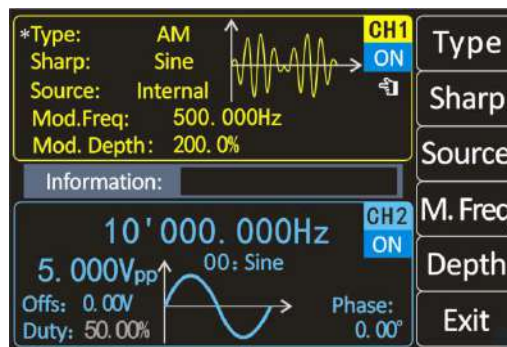

Figure 3-3-1 Modulation interface

AM

Amplitude modulation is a modulation method in which the amplitude of the carrier wave changes according to the change law of the desired transmission signal, but the frequency remains unchanged.

➤ Select carrier waveforms

The carrier waveforms of amplitude modulation can be sine wave, square wave, ramp wave or arbitrary wave (except DC signal wave). The default is sine wave.

Press the **【Wave】** key on the waveform interface and use the knob to select the desired carrier waveform. The DC signal wave in pulse wave, noise wave and arbitrary wave cannot be used as carrier. The different settings of multiple parameters of the carrier waveforms (such as frequency, amplitude, offset, and starting phase, etc.) will affect the output of the AM modulated waveform. For different carrier waveforms, the settable range of each parameter of the carrier is also different (related to the model of the instrument you are using and the selected carrier waveform, see **“Specifications”** for details).

For the setting method of carrier parameters, please refer to the relevant introduction in the section “Output Basic Waveform”.

➤ To Select AM

Press **【MOD】** → double click **【Type】** → **【AM】** to enable the amplitude modulation function or select the amplitude modulation by adjusting the knob.

➤ To Select Source

The PSG9080 can accept modulation waveforms from internal or external

modulation sources.

Press **【Signal Source】** to select “Internal” or “External” modulation source.

◆ **Internal**

After selecting the internal modulation source, press the **【Wave】** soft key to select sine wave, square wave, triangle wave, ascending ramp, descending ramp and arbitrary wave as the modulation source. The default is sine wave.

◆ **External**

When the external modulation source is selected, the signal generator accepts the external modulation signal input from the MOD connector on the front panel.

The frequency range of the external signal is 0~20kHz, and the amplitude range is -5V~+5V.

➤ **To Set the Modulation Wave Frequency**

After using the “Internal” modulation source, press the **【Freq.】** soft key to set the frequency of the modulated wave.

Use the numeric keyboard or direction keys and knob to input the desired frequency value.

The modulation frequency range is from 0.001Hz to 1MHz, and the default is 500Hz.

➤ **To Set Modulation Depth**

The modulation depth indicates the degree of amplitude change, expressed as a percentage. The range of amplitude modulation depth can be set from 0% to 200%. Press **【Depth】** soft key to set the amplitude modulation depth.

FM

Frequency modulation is a modulation method that changes the carrier frequency according to the modulation signal. The magnitude of the frequency change of the modulated wave is determined by the size of the modulation signal, and the period of the change is determined by the frequency of the modulation signal.

➤ **To Select Carrier Waveform**

Refer to “To select carrier waveform” in “AM”

The DC signal wave of pulse wave, noise wave and arbitrary wave cannot be used as carrier.

➤ **To Select FM**

Press **【MOD】** → double click **【Type】** → **【FM】** to enable the FM function or select the FM by adjusting the knob.

➤ To Select Source

The PSG9080 can accept modulation waveforms from internal or external modulation sources.

Press **【Source】** to select “Internal” or “External” modulation source.

◆ Internal

After selecting the internal modulation source, press the **【Wave】** soft key to select sine wave, square wave, triangle wave, ascending ramp, descending ramp and arbitrary wave as the modulation source. The default is sine wave.

◆ External

When the external modulation source is selected, the signal generator accepts the external modulation signal input from the MOD connector on the front panel.

The frequency range of the external signal is 0~20kHz, and the amplitude range is -5V~+5V.

➤ To Set the Modulation Wave Frequency

After using the “Internal” modulation source, press the **【Freq.】** soft key to set the frequency of the modulated wave.

Use the numeric keyboard or direction keys and knob to input the desired frequency value.

The modulation frequency range is from 0.001Hz to 1MHz, and the default is 500Hz.

➤ To Set Frequency Deviation

Frequency deviation refers to the deviation of the frequency of the modulation waveform relative to the carrier frequency. Press **【FM.Dev】** soft key to set FM frequency deviation.

PM

Phase modulation is a modulation method in which the deviation of the carrier phase from its reference phase changes in proportion to the instantaneous value of the modulation signal.

➤ To Select Carrier Waveform

Refer to “To select carrier waveform” in “AM”.

The DC signal wave of pulse wave, noise wave and arbitrary wave cannot be used as carrier.

➤ To Select PM

Press **【MOD】** → double-click **【Type】** → **【PM】** to enable the PM function or select the PM by adjusting the knob.

➤ To Select Source

The PSG9080 can accept modulation waveforms from internal or external modulation sources.

Press **【Source】** to select “Internal” or “External” modulation source.

◆ **Internal**

After selecting the internal modulation source, press the **【Wave】** soft key to select sine wave, square wave, triangle wave, ascending ramp, descending ramp and arbitrary wave as the modulation source. The default is sine wave.

◆ **External**

When the external modulation source is selected, the signal generator accepts the external modulation signal input from the MOD connector on the front panel.

The frequency range of the external signal is 0~20kHz, and the amplitude range is -5V~+5V.

➤ **To Set the Modulation Wave Frequency**

After using the “Internal” modulation source, press the **【Freq.】** soft key to set the frequency of the modulated wave.

Use the numeric keyboard or direction keys and knob to input the desired frequency value.

The modulation frequency range is 0.001Hz to 1MHz, and the default is 500Hz.

➤ **To Set Modulation Wave Phase Deviation**

Phase deviation refers to the change in the phase of the modulated waveform relative to the carrier phase. Press **【PM.Dev】** soft key to set phase modulation phase deviation.

Use the numeric keyboard or direction keys and knob to input the desired deviation value.

The setting range of the phase deviation is 0° to 359.9° , and the default value is 180° .

ASK

The modulation method that uses the baseband digital signal to control the amplitude variation of the carrier wave is called amplitude shift keying (ASK), also known as digital amplitude modulation.

➤ **To Select Carrier Waveform**

Refer to “To select carrier waveform” in “AM”.

The DC signal wave of pulse wave, noise wave and arbitrary wave cannot be used as carrier.

➤ **To Select ASK**

Press **【MOD】** → double click **【Type】** → **【ASK】** to enable the ASK function or select ASK by adjusting the knob.

➤ **To Set Polarity**

Press the **【Polar】** softkey to select the amplitude of the modulated wave

controlled by “positive polarity” or “negative polarity”.

◆ **Internal**

During internal modulation, if the polarity is set to “positive polarity”, the smaller amplitude between the carrier amplitude and the modulation amplitude is output when the modulation wave is at a logic low level; the larger amplitude between the carrier amplitude and the modulation amplitude is output when the modulation wave is at a logic high level. When the polarity is “negative”, the situation is reversed.

◆ **External**

During external modulation, if the polarity is set to “positive polarity”, the smaller amplitude between the carrier amplitude and the modulation amplitude is output when the external input signal is at a logic low level; the larger amplitude between the carrier amplitude and the modulation amplitude is output when the external input signal is at a logic high level. When the polarity is “negative”, the situation is reversed.

➤ **To Select Source**

The PSG9080 can accept modulation waveforms from internal or external modulation sources.

Press **【Source】** to select “Internal” or “External” modulation source.

◆ **Internal**

Select the internal modulation source, that is, select a square wave with a duty cycle of 50% as the modulation waveform. At this time, the frequency at which the output amplitude moves between the carrier amplitude and the modulation amplitude is determined by the modulation rate.

◆ **External**

When the external modulation source is selected, the signal generator accepts the external modulation signal input from the MOD connector on the front panel.

The frequency range of the external signal is 0~20kHz, and the amplitude range is -5V~+5V.

➤ **To Set Modulation Rate**

After using the “Internal” modulation source, press the **【Rate】** soft key to set the modulation rate.

Use the numeric keyboard or direction keys and knob to input the desired frequency value.

The frequency range is 0.001Hz to 1MHz, and the default is 500Hz.

➤ **To Set ASK Amplitude**

Press **【Ampl.】** soft key to set ASK amplitude.

Use the numeric keyboard or direction keys and knob to input the desired amplitude value.

ASK amplitude range is 0%-200%, the default is 80%.

FSK

The modulation method to control the change of carrier frequency is called frequency shift keying (FSK).

➤ To Select Carrier Waveform

Refer to “To select carrier waveform” in “AM”.

The DC signal wave of pulse wave, noise wave and arbitrary wave cannot be used as carrier.

➤ To Select FSK

Press **【MOD】** → double click **【Type】** → **【FSK】** to enable the FSK function or select the FSK by adjusting the knob.

➤ To Set Polarity

Press the **【Polar】** softkey to select the amplitude of the modulated wave controlled by “Positive polarity” or “Negative polarity”.

◆ **Internal**

During internal modulation, if the polarity is set to “Positive polarity”, the carrier frequency is output when the amplitude of the modulated wave is at a logic low level; and the hop frequency is output when the amplitude of the modulated wave is at a logic high level. When the polarity is “Negative”, the situation is reversed.

◆ **External**

During external modulation, if the polarity is set to “Positive polarity”, the carrier frequency is output when the external input signal is at a logic low level; when the external input signal is at a logic high level, the hop frequency is output. When the polarity is “Negative”, the situation is reversed.

➤ To Select Source

The PSG9080 can accept modulation waveforms from internal or external modulation sources.

Press **【Source】** to select “Internal” or “External” modulation source.

◆ **Internal**

Select the internal modulation source, that is, select a square wave with a duty cycle of 50% as the modulation waveform. At this time, the frequency at which the output amplitude moves between the carrier amplitude and the modulation amplitude is determined by the modulation rate.

◆ **External**

When the external modulation source is selected, the signal generator accepts the external modulation signal input from the MOD connector on the front panel.

The frequency range of the external signal is 0~20kHz, and the amplitude range is -5V~+5V.

➤ To Set Modulation Rate

After using the “Internal” modulation source, press the **【Rate】** soft key to set the modulation rate.

Use the numeric keyboard or direction keys and the knob to input the

desired frequency value.

The frequency range is 0.001Hz to 1MHz, and the default is 500Hz.

➤ To Set Hop Frequency

Press **【Hop.F】** soft key to set the hop frequency.

Use the numeric keyboard or direction keys and the knob to input the desired frequency value.

PSK

Phase shift keying (PSK): A modulation technique that uses carrier phase to represent input signal information. Definition of phase shift keying: each characteristic state of a discrete modulation signal in time is an angular modulation represented by a specific difference between the phase of the modulated signal and the carrier phase before modulation.

➤ To Select carrier waveform

Refer to “To Select Carrier Waveform” in “AM”.

The DC signal wave of pulse wave, noise wave and arbitrary wave cannot be used as carrier.

➤ To Select PSK

Press **【MOD】** → triple click **【Type】** → **【PSK】** to enable the PSK function or select the PSK by adjusting the knob.

➤ To Set Polarity

Press the **【Polar】** softkey to select the amplitude of the modulated wave controlled by “positive polarity” or “negative polarity”.

During internal modulation, if the polarity is set to “positive polarity”, the carrier phase is output when the amplitude of the modulation wave is at a logic low level; and the modulation phase is output when the amplitude of the modulation wave is at a logic high level. When the polarity is “negative”, the situation is reversed.

During external modulation, if the polarity is set to “positive polarity”, the carrier phase is output when the external input signal is at a logic low level; the modulation phase is output when the external input signal is at a logic high level. When the polarity is “negative”, the situation is reversed.

➤ To Select Source

The PSG9080 can accept modulation waveforms from internal or external modulation sources.

Press **【Source】** to select “Internal” or “External” modulation source.

◆ **Internal**

Select the internal modulation source, that is, select a square wave with a duty cycle of 50% as the modulation waveform. At this time, the frequency at which the output amplitude moves between the carrier amplitude and the modulation amplitude is determined by the modulation rate.

◆ **External**

When the external modulation source is selected, the signal generator accepts the external modulation signal input from the MOD connector on the

front panel.

The frequency range of the external signal is 0~20kHz, and the amplitude range is -5V~+5V.

➤ To Set Modulation Rate

After using the “Internal” modulation source, press the **[Rate]** soft key to set the modulation rate.

Use the numeric keyboard or direction keys and the knob to input the desired frequency value.

The frequency range is 0.001Hz to 1MHz, and the default is 500Hz.

➤ To Set PSK

Press **[PSK]** soft key to set PSK phase.

Use the numeric keyboard or direction keys and the knob to input the desired frequency value.

The PSK phase range is 0° to 359.9°.

Pulse Function

Digital adjustment of the pulse width and pulse period time of the pulse wave can be achieved, which is more accurate than adjusting the duty cycle.

➤ To Select Carrier Waveform

The pulse modulated waveform can only be a pulse wave.

➤ To Select Pulse

Press **[MOD]** → triple click **[Type]** → **[Pulse]** to enable the pulse function or select the pulse by adjusting the knob.

➤ To Set Wave Inversion

Press **[W.Inv]** soft key, you can select normal and reverse to control the output.

➤ To Set Pulse Width

Press **[Pulse]** soft key to set the pulse width.

Use the numeric keyboard or direction keys and the knob to input the desired value (the unit can be us, ms, s).

The pulse width range is 0.001us to 4s, and the default is 0.100us.

➤ To Set Pulse Period

Press **[Period]** soft key to set the pulse period.

Use the numeric keyboard or direction keys and the knob to input the desired frequency value.

The period length range is from 0.001us to 40s, and the default is 10.00us.

Burst Function

It can be set to output 1-1000000000 burst signals. The trigger modes include internal trigger, external trigger (rising edge) and manual trigger. During use, it should be noted that the period of the burst signal should be less than the period of the trigger signal.

- To Select Carrier Waveform
Refer to “**To select carrier waveform**” in “AM”.
- To Select Burst
Press **【MOD】** → triple click **【Type】** → **【Burst】** to enable the burst function or select the burst by adjusting the knob.
- To Set Idle Mode
Press **【Idle】** soft key, you can select zero, positive maximum and negative maximum control output.
- To Select Trigger Source
Press **【T.Src】** soft key to select the trigger mode.
 - ◆ **Press the Soft Key**
Trigger by key: Single output can be achieved by pressing **【Trig.】** soft key .
 - ◆ **Internal**
Internal trigger: The signal can be output through the CH2 channel of the signal generator.
 - ◆ **External AC**
External AC signal trigger
 - ◆ **External DC**
External DC signal trigger
- To Set Pulse Number
Press **【Num.】** soft key to set the number of pulses.
Use the numeric keyboard or direction keys and the knob to input the desired pulse number.
The number of pulses range is from 1 to 1000000000, and the default is 1.

4.Parameters Setting of Measurement Mode Interface

Press **【MEAS】** in the measurement mode interface and press the **【CNTR.】** soft key to switch between the measurement function and the counter function, or you can turn the knob to switch. The measurement interface is shown below.

Measurement function description video:

http://68.168.132.244/PSG9080CLGN_EN.mp4

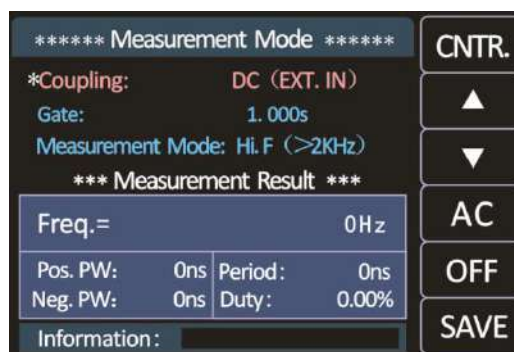

Figure 3-4-1 Measurement interface

Measurement Function

It can measure the frequency, period, positive pulse width, negative pulse width, and duty cycle of the input signal. The measurement frequency range is 1Hz-100MHz, the measurement signal amplitude range is 2Vpp-20Vpp, and the input interface is Ext.IN.

➤ Coupling Setting

Press the soft keys to make the cursor at the coupling position switch the coupling mode (AC or DC) by adjusting the knob.

➤ Gate Time Setting

Press to place the cursor at the gate position. Use the numeric keyboard or direction keys and the knob to enter the desired gate time.

The gate time range is from 0.001s to 10s, and the default is 1s.

➤ Measurement Mode

Press to place the cursor in the measurement mode, and use the knob to switch the measurement mode (low frequency <2kHz or high frequency >2kHz).

Measurement parameters: frequency, period, positive pulse width, negative pulse width, duty cycle.

Counter Function

The number of input signal periods can be calculated in real time.

➤ Coupling Setting

Press the soft keys to make the cursor at the coupling position switch the coupling mode (AC or DC) by adjusting the knob.

After setting all items, press the soft key to start the counting function, press the soft key to stop, press the soft key to restore the default settings, and press the soft key to save the parameters.

5.Parameters Setting of Frequency Sweep Mode Interface

Press **[SWEEP]** and press the **[FUNC]** softkey in the frequency sweep mode interface to select the frequency sweep, amplitude sweep, and duty cycle sweep functions.

Press **[SAVE]** soft key to quickly save the parameters to the M00 position. The frequency sweep interface is shown as Figure 3-5-1.

Sweep function description video:

http://68.168.132.244/PSG9080SMGN_EN.mp4



Figure 3-5-1 Frequency sweep interface

Sweep Frequency

➤ Sweep Channel

Switch the frequency sweep channels by pressing **[CH1]** **[CH2]** soft keys.

➤ Start Frequency and End Frequency

The start frequency and end frequency are the upper and lower frequency limits of the frequency sweep.

➤ Sweep Time

Press the **▲** **▼** soft keys to position the cursor at the sweep time, and use the numeric keyboard or direction keys and the knob to input the desired scan time. The sweep time range is from 0.01s to 640s.

➤ Sweep Direction

Press the **▲** **▼** soft keys to make the cursor position in the sweep direction, three directions for selecting: round trip, increment and decrement.

➤ Sweep Mode

Press the **▲** **▼** soft keys to place the cursor in the sweep mode, and you can choose between linear and logarithmic modes.

➤ Turn on Frequency Sweep

Press the **[ON]** soft key, the instrument starts to sweep the frequency, and

the frequency change can be observed on the display interface.

Sweep Amplitude

Press the **[FUNC]** soft key to select the sweep amplitude function.

➤ Sweep Amplitude Channel

Switch the amplitude sweep channels by pressing **[CH1]** **[CH2]** soft keys.

➤ Start Amplitude and End Amplitude

The start amplitude and end amplitude are the upper and lower amplitude limits of the amplitude sweep.

➤ Sweep time, Sweep direction, Sweep mode

You can refer to “Sweep time, Sweep direction, Sweep mode” in “Sweep frequency”.

➤ Turn on Sweep Amplitude

Press the **[ON]** soft key, the instrument starts to sweep the amplitude, and the amplitude change can be observed on the display interface.

Sweep Duty Cycle

Press the **[FUNC]** soft key to select the sweep duty cycle function.

➤ Sweep Duty Cycle Channel

You can press **[CH1]** **[CH2]** soft keys to switch the sweep duty cycle channel.

➤ Start Duty Cycle and End Duty Cycle

The start duty cycle and the end duty cycle are the upper and lower limits of the duty cycle of the duty cycle sweep.

➤ Sweep Time, Sweep Direction, Sweep Mode

Refer to “Sweep time, Sweep direction, Sweep mode” in “Sweep frequency”.

➤ Turn on Duty Cycle

Press the **[ON]** soft key, the instrument starts to sweep the duty cycle, and the duty change can be observed on the display interface.

6.Parameters Setting of Voltage Control Mode Interface

Press **[VOC]** and press the **[FUNC]** soft key in the voltage control mode interface to select frequency control, amplitude control, and duty control functions.

Press the **[SAVE]** soft key to quickly save the parameters to the M00 position. The voltage control interface is shown as Figure 3-6-1.

Voltage Control function description video:

http://68.168.132.244/PSG9080YKGN_EN.mp4

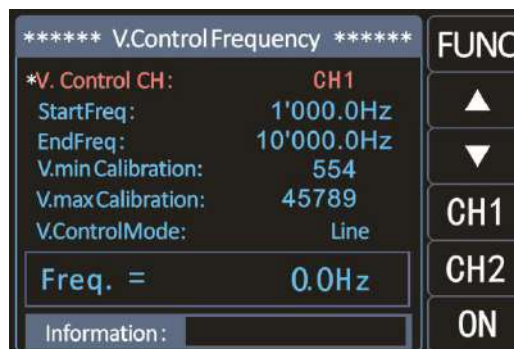

Figure 3-6-1 Voltage Control Interface

Voltage Control Frequency

Press the **[FUNC]** soft key in the voltage control interface to select the frequency control.

➤ Voltage Control Channel

You can press **[CH1]** **[CH2]** soft keys to switch the frequency sweep channels.

➤ Start Frequency and End Frequency

Refer to “Start frequency and End frequency” in “Sweep frequency”.

➤ Minimum Voltage Calibration and Maximum Voltage Calibration

The maximum and minimum values of the external input signal voltage can be calibrated.

➤ Voltage Control Mode

Press **▲** **▼** to place the cursor in the voltage control mode, and you can choose linear and logarithmic modes.

➤ Turn on Voltage Vontrol Frequency

Press the **[ON]** soft key, the instrument turns on the voltage control frequency, and the frequency change can be observed on the display interface.

Voltage Control Amplitude

Press the **[FUNC]** soft key in the voltage control interface to select the amplitude control.

➤ Voltage Control Channel

You can press **[CH1]** **[CH2]** soft keys to switch the voltage control channels.

- **Start Amplitude and End Amplitude**
You can refer to “Start amplitude and end amplitude” in “Sweep amplitude”.
- **Minimum Voltage Calibration and Maximum Voltage Calibration**
The maximum and minimum values of the external input signal voltage can be calibrated.
- **Voltage Control Mode**
Press **▲** **▼** to place the cursor in the voltage control mode, and you can choose linear and logarithmic modes.
- **Turn On Voltage Control Amplitude**
Press the **[ON]** soft key, the instrument turns on the voltage control amplitude, and the amplitude change can be observed on the display interface.

Voltage Control Duty Cycle

Press the **[FUNC]** soft key in the voltage control interface to select the duty cycle control.

- **Voltage Control Channel**
You can press **[CH1]** **[CH2]** soft keys to switch the voltage control channels.
- **Start Duty Cycle and End Duty Cycle**
Refer to “**Start duty cycle and End duty cycle**” in “**Sweep duty cycle**”.
- **Minimum Voltage Calibration and Maximum Voltage Calibration**
The maximum and minimum values of the external input signal voltage can be calibrated.
- **Voltage Control Mode**
Press **▲** **▼** to place the cursor in the voltage control mode, and you can choose linear and logarithmic modes.
- **Turn on Voltage Control Duty Cycle**
Press the **[ON]** soft key, the instrument turns on the voltage control duty cycle, and the duty cycle change can be observed on the display interface.

7.Parameters Setting of Programming Mode Interface

Press **[FUNC]** to enter the programming mode interface, and press the **[MODE]** soft key to switch between normal mode and debugging mode. In programming mode, press **[SAVE]** soft key to save data in time. The programming interface is shown as Figure 3-7-1.

Programming function description video:

http://68.168.132.244/PSG9080BCGN_EN.mp4

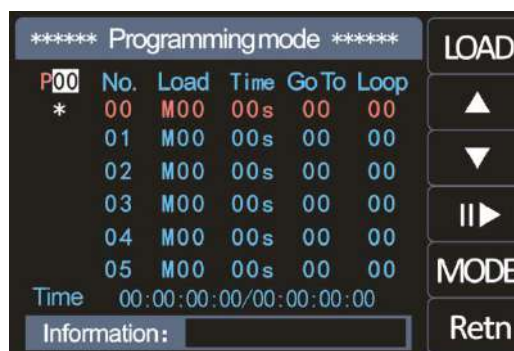

Figure 3-7-1 programming interface

Normal Mode and Debug Mode

Press the **【MODE】** soft key to switch between normal mode and debug mode.

Under P00, the debug mode is *, the normal mode is ●, the debug mode is run on the programming interface, and the normal mode is run on the interface of the storage location.

P00

P00 represents the storage position in programming mode. There are P00-P19 group positions.

Serial Number

The serial number 00 indicates an instruction, and there are a total of 00-99 sets of instructions.

Load

M00 indicates the location where the parameter is stored.

Time

Time 00S indicates the current running time of the serial number.

Time: 00:00:00:00/00:00:00:00 indicates the current running time/total running time.

Go to

The value in the Go to indicates the serial number to be gone. When the value in the Go to is 05, after the current serial number run is completed, it is transferred to the 05 serial number to start to run.

Cycle

Cycle means the current serial number cycle, when the cycle is set to 05, it means that the cycle is 5 times, and the value is decremented by one every time, and it will not be recycled until 00.

8. System Setup

Press the **【SYS】** key to enter the system setup interface, and press the **▲ ▼** soft key to select items such as clear storage, sound, brightness, language, built-in wave number, arbitrary wave number, waveform loading methods, system information, etc. The system setting interface is shown below.

System setup description video:

http://68.168.132.244/PSG9080XTSZ_EN.mp4



Figure 3-8-1 System interface

Clear Storage: used to clear the parameters stored in the current position, turn the knob to adjust to the specified position to clear.

Sound Setting: You can turn on and off the sound through the **【ON】** and **【OFF】** soft keys.

Brightness Adjustment: You can quickly adjust the brightness through the numeric keys and the knob.

Language Setting: English and Chinese language can be selected through **【ENG】** and **【中文】**.

Built-in Wave Number: the number of built-in waves of the instrument can be set through the numeric keys and the knob, the rang is from 00 to 21.

Arbitrary Wave Number: The number of arbitrary waves of the instrument can be set through the numeric keys and the knob, the rang is from 01 to 99.

Waveform Loading Methods: You can select the waveform loading methods through **【Auto】** and **【Fast】**.

System Information: Press the **【About】** soft key to see the product model, hardware version, software version, FPGA version, official website and official QR code of this instrument.

❖ **PSG9080 can update the firmware. Press the **【Update】** soft key to**

enter the update mode. By connecting with the PC software, you can upgrade the firmware in one key.

The firmware upgrade interfaces are shown below.

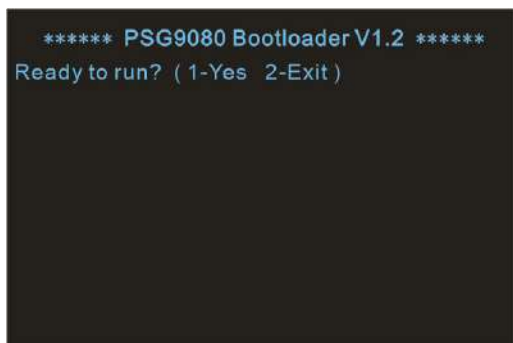

Figure 3-8-2 Start running interface

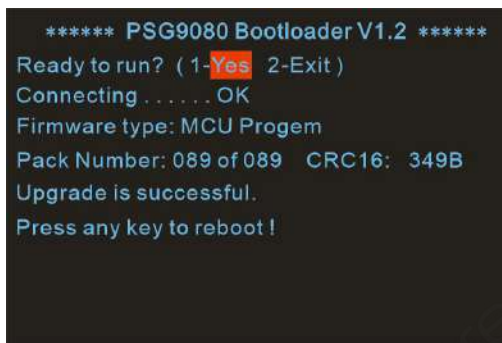

Figure 3-8-3 Running completion interface

Press the **【PgDn】** soft key to enter the second page of system settings.

During synchronization, the parameters of the CH2 channel change with the parameters of the CH1 channel.

Waveform synchronization: The waveform synchronization can be turned on and off through the **【ON】** and **【OFF】** soft keys.

Frequency synchronization: The frequency synchronization can be turned on and off through the **【ON】** and **【OFF】** soft keys.

Amplitude synchronization: The amplitude synchronization can be turned on and off through the **【ON】** and **【OFF】** soft keys.

Duty cycle synchronization: The duty cycle synchronization can be turned on and off through the **【ON】** and **【OFF】** soft keys.

External synchronization: The external synchronization can be turned on and off through the **【ON】** and **【OFF】** soft keys.

Frequency fine-tuning: You can adjust the frequency to synchronize the waveform, and the adjustment range is 0-99.

Restore factory settings: Press the **【ON】** soft key, select **【Yes】** to restore the factory settings, and display Running.....OK! in the message box, indicating successful operation.

Press the **【PgDn】** soft key to enter the third page of system settings.

System Color: There are four system colors. You can select the desired system color through the numeric keys and the knob, and press the **【SAVE】** soft key to save the system color. The system color interfaces are shown as Figure 3-8-4 to Figure 3-8-7.

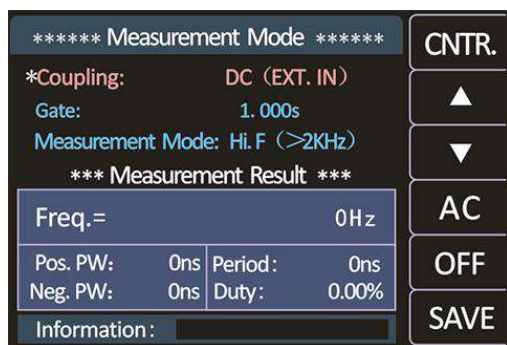

Figure 3-8-4 System color 01



Figure 3-8-5 System color 02



Figure 3-8-6 System color 03

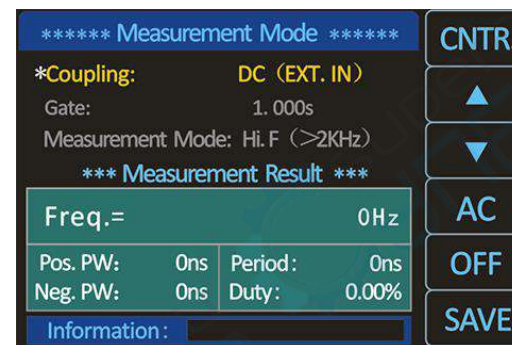

Figure 3-8-7 System color 04

Auto power-on: You can turn on and off the auto power-on through the soft keys **[ON]** and **[OFF]**. After the auto power-on function is turned on, the instrument output is powered on by default.

CH1/CH2 amplitude fine-tuning: When the output amplitude of the CH1/CH2 channel waveform is slightly different from the measured amplitude, you can change the value of the CH1/CH2 amplitude fine-tuning and perform online calibration to obtain accurate amplitudes. The default CH1/CH2 amplitude fine-tuning value is 50.

9.PC Software Control Output

Communication protocol and the software link:
http://68.168.132.244/PSG9080_EN_Setup.zip

PC installation instruction video:
http://68.168.132.244/PSG9080SWJAZ_EN.mp4

Setup the Software

➤ Step 1: The PC software has both Chinese and English operation interfaces, select the corresponding interface. The language selection interface is shown as Figure 3-9-1.



Figure3-9-1

- Step 2: Click the key **【Install USB Drive】** to install the serial port driver. The installation driver interfaces are shown below.



Figure3-9-2



Figure3-9-3

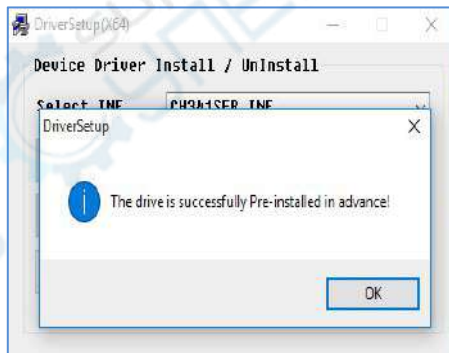

Figure3-9-4

- Step 3: Click the key **【Main program】** to install the application. Keep clicking the **【NEXT】** until the **【FINISH】** displayed, and then click it to complete the installation. The application installation interfaces are shown as Figure 3-9-5 to Figure 3-9-10.

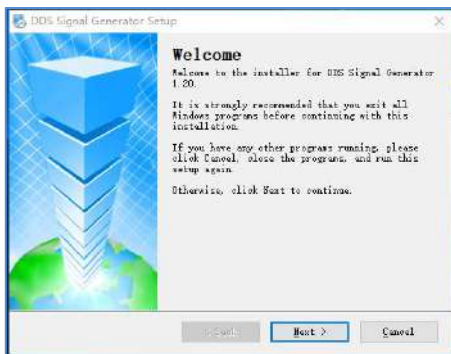

Figure 3-9-5

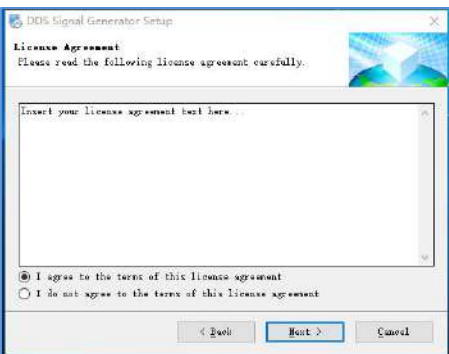

Figure 3-9-6

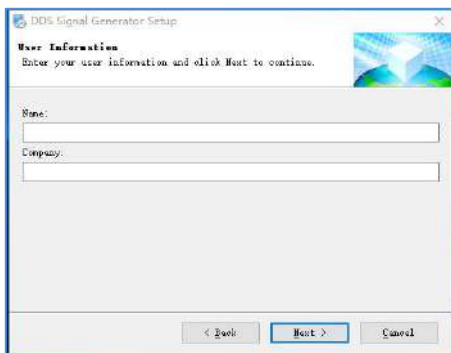

Figure 3-9-7

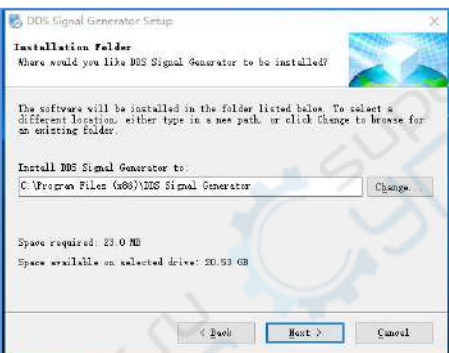

Figure 3-9-8

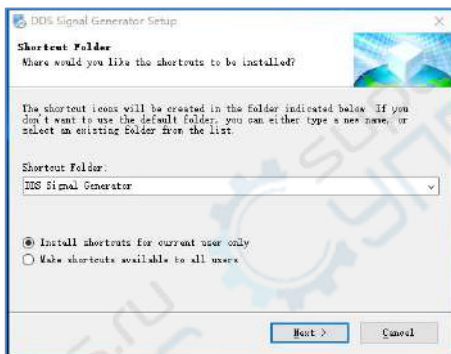

Figure 3-9-9

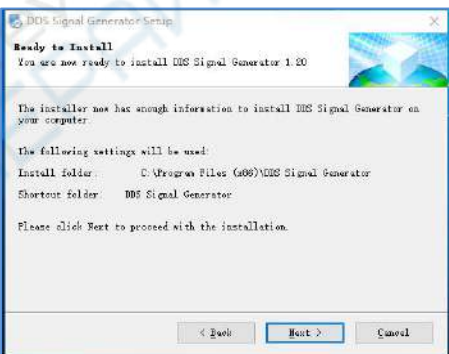

Figure 3-9-10

(2) Connect

➤ Step 1: Right-click Computer → Properties → Device Manager → Observe the serial port assigned by the computer. The computer serial port assignment interface is shown as Figure 3-9-11.

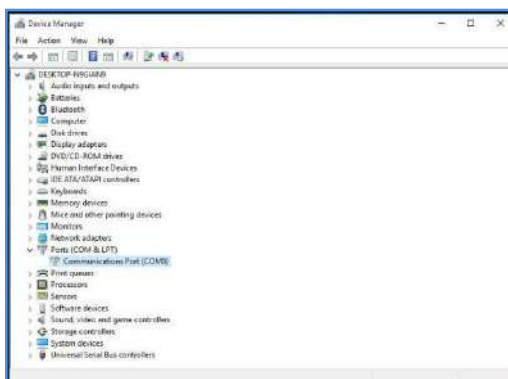

Figure 3-9-11
39

- Step 2: After selecting the corresponding serial port, open the serial port, and then connect. The connecting interface is shown as Figure 3-9-12.

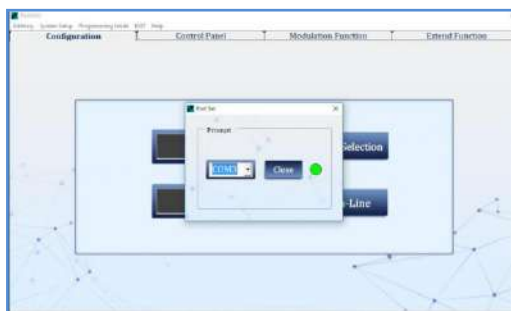

Figure 3-9-12

- Step 3: The connection is successful. The interface for successful connection is shown as Figure 3-9-13.

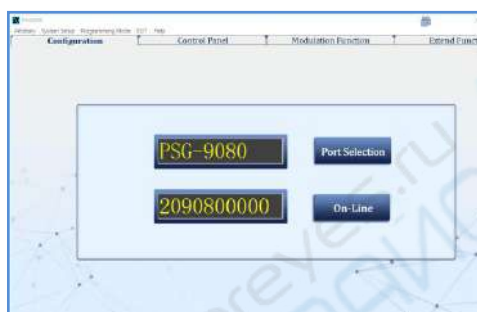

Figure 3-9-13

Troubleshooting

This chapter lists the commonly encountered failures of PSG9080 and their solutions. When you encounter those problems, please solve them following the corresponding steps. If the problem remains still, please contact **JUNTEK** and provide the device information of your instrument (Press **【SYS】** key view the instrument system information).

The screen of the generator is still dark (no display) after pressing the power key:

- Check whether the power is correctly connected.
- Check whether the power key is really pressed.
- Restart the instrument after finishing the above inspections.
- If it still does not work correctly, please contact **JUNTEK**.

The screen is too dark to see the contents on the screen clearly:

- Check whether the brightness and contrast settings are too low.
- Press the **【SYS】** key to enter the system setting menu, and then press the **▲ ▼** soft key to place the cursor at the brightness position, adjust the brightness of the screen to appropriate values using the knob respectively.

The settings are correct but no waveform is generated:

- Check whether the BNC cable is connected to the corresponding channel output terminal (**【CH1】** or **【CH2】**) tightly.
- Check whether the BNC cable has internal damage.
- Check whether the BNC cable is connected to the test instrument tightly.
- Check whether the backlight of CH1 or CH2 is turned on. If not, press the corresponding key to illuminate the backlight.
- After finishing the above inspections, press and then restart the instrument.
- If it still does not work correctly, please contact **JUNTEK**.

For More Product Information

You can obtain the instrument information including machine model and factory number by pressing the **【SYS】** key.

For more information about this instrument, refer to the relevant manuals by logging in to the official website of JUNTEK (www.junteks.com) to download them.

"PSG9080 Operation Demo Video" provides operation video of this product.

"PSG9080 PC Software and Communication Protocol" provides corresponding PC software and communication protocol for this product.

"PSG9080 User Manual" includes the technical specifications, the functions of the instrument and operation methods, possible failures and solutions in using the instrument and other information.

Warranty

JUNTEK warrants that the product mainframe and product accessories will be free from defects in materials and workmanship within the warranty period.

If a product proves defective within the respective period, **JUNTEK** guarantees free replacement or repair of any defective products within a reasonable period of time. To get repair service, please contact with your nearest **JUNTEK** sales or service office. There is no other warranty, expressed or implied, except such as is expressly set forth herein or other applicable warranty card. There is no implied warranty of merchantability or fitness for a particular purpose. Under no circumstances shall **JUNTEK** be liable for any consequential, indirect, ensuing or special damages for any breach of warranty in any case.