

RIGOL

Quick Guide

English

中文

RSA3000 Series Real-time Spectrum Analyzer

Jul. 2020

RIGOL TECHNOLOGIES CO., LTD



Guaranty and Declaration

Copyright

© 2020 **RIGOL** TECHNOLOGIES CO., LTD. All Rights Reserved.

Trademark Information

RIGOL® is the trademark of **RIGOL** TECHNOLOGIES CO., LTD.

Publication Number

QGD21103-1110

Notices

- **RIGOL** products are covered by P.R.C. and foreign patents, issued and pending.
- **RIGOL** reserves the right to modify or change parts of or all the specifications and pricing policies at the company's sole decision.
- Information in this publication replaces all previously released materials.
- Information in this publication is subject to change without notice.
- **RIGOL** shall not be liable for either incidental or consequential losses in connection with the furnishing, use, or performance of this manual, as well as any information contained.
- Any part of this document is forbidden to be copied, photocopied, or rearranged without prior written approval of **RIGOL**.

Product Certification

RIGOL guarantees that this product conforms to the national and industrial standards in China as well as the ISO9001:2015 standard and the ISO14001:2015 standard. Other international standard conformance certifications are in progress.

Contact Us

If you have any problem or requirement when using our products or this manual, please contact **RIGOL**.

General Safety Summary

1. Only the exclusive power cord designed for the instrument and authorized for use within the local country could be used.
2. Ensure that the instrument is safely grounded.
3. Observe all terminal ratings.
4. Use proper overvoltage protection.
5. Do not operate without covers.
6. Do not insert objects into the air outlet.
7. Use the proper fuse.
8. Avoid circuit or wire exposure.
9. Do not operate the instrument with suspected failures.
10. Provide adequate ventilation.
11. Do not operate in wet conditions.
12. Do not operate in an explosive atmosphere.
13. Keep instrument surfaces clean and dry.
14. Prevent electrostatic impact.
15. Handle with caution.

Safety Notices and Symbols

Safety Notices in this Manual:



WARNING

Indicates a potentially hazardous situation or practice which, if not avoided, will result in serious injury or death.



CAUTION

Indicates a potentially hazardous situation or practice which, if not avoided, could result in damage to the product or loss of important data.

Safety Terms on the Product:

DANGER

It calls attention to an operation, if not correctly performed, could result in injury or hazard immediately.

WARNING

It calls attention to an operation, if not correctly performed, could result in potential injury or hazard.

CAUTION

It calls attention to an operation, if not correctly performed, could result in damage to the product or other devices connected to the product.

Safety Symbols on the Product:



Hazardous
Voltage



Safety
Warning



Protective Earth
Terminal



Chassis Ground



Test Ground

Care and Cleaning

Care

Do not store or leave the instrument where it may be exposed to direct sunlight for long periods of time.

Cleaning

Clean the instrument regularly according to its operating conditions.

1. Disconnect the instrument from all power sources.
2. Clean the external surfaces of the instrument with a soft cloth dampened with mild detergent or water. When cleaning the LCD, take care to avoid scarifying it.



CAUTION

To avoid damage to the instrument, do not expose it to caustic liquids.



WARNING

To avoid short-circuit resulting from moisture or personal injuries, ensure that the instrument is completely dry before connecting it to the power supply.

Document Overview

This manual introduces some basic information that you should know when you use the RSA3000 series spectrum analyzer for the first time. It contains the following contents: out-of-box inspection method, product overview, how to connect the instrument to the AC power, turn-on checkout, and remote control overview.

Tip

For the latest version of this manual, download it from the official website of **RIGOL**.

Format Conventions in this Manual

1. Keys:

The keys on the front panel are usually denoted by the format of "Key Name (Bold) + Text Box". For example, **FREQ** denotes the **FREQ** key.

2. Menu Keys:

The menu softkeys are usually denoted by the format of "Menu Word (Bold) + Character Shading". For example, **Center Freq** denotes the center frequency menu under the **FREQ** function key.

3. Connectors:

The connectors on the front or rear panel are usually denoted by the format of "Connector Name (Bold) + Square Brackets (Bold)". For example, **[Gen Output 50Ω]**.

4. Operation Procedures:

"→" represents the next step of operation. For example, **FREQ** → **Center Freq** indicates pressing **FREQ** on the front panel and then pressing the menu softkey **Center Freq**.

Content Conventions in this Manual

English

The RSA3000 series spectrum analyzer includes the following models. Unless otherwise specified, this manual takes RSA3045-TG as an example to illustrate the functions and operation methods of RSA3000 series spectrum analyzer.

Model	Frequency Range	Tracking Generator
RSA3045	9 kHz to 4.5 GHz	None
RSA3030	9 kHz to 3 GHz	None
RSA3045-TG	9 kHz to 4.5 GHz	4.5 GHz
RSA3045N	9 kHz to 4.5 GHz	4.5 GHz
RSA3030-TG	9 kHz to 3 GHz	3 GHz
RSA3030N	9 kHz to 3 GHz	3 GHz
RSA3015N	9 kHz to 1.5 GHz	1.5 GHz

NOTE: The RSA3000N models include hardware capability not in the RSA3000-TG. The RSA3000-TG models cannot be used in VNA mode.

General Inspection

1. Inspect the packaging

If the packaging has been damaged, do not dispose the damaged packaging or cushioning materials until the shipment has been checked for completeness and has passed both electrical and mechanical tests.

The consigner or carrier shall be liable for the damage to the instrument resulting from shipment. **RIGOL** would not be responsible for free maintenance/rework or replacement of the instrument.

2. Inspect the instrument

In case of any mechanical damage, missing parts, or failure in passing the electrical and mechanical tests, contact your **RIGOL** sales representative.

3. Check the accessories

Please check the accessories according to the packing lists. If the accessories are damaged or incomplete, please contact your **RIGOL** sales representative.

Product Overview

RSA3000 series is a new generation of cost-efficient real-time spectrum analyzer with high performance. With superb performance specifications, as well as the clear user interface, the RSA3000 series allows you to operate it through various ways, such as pressing keys on the front panel, using the touch screen, connecting the mouse and the keyboard. Remote communication interfaces are also available. The instrument can be widely used in education science, corporate R&D, industrial production, and other fields.

For descriptions of the front panel, refer to Figure 1; for descriptions of the rear panel, refer to Figure 2; and for descriptions of the main interface (LCD), refer to Figure 3.

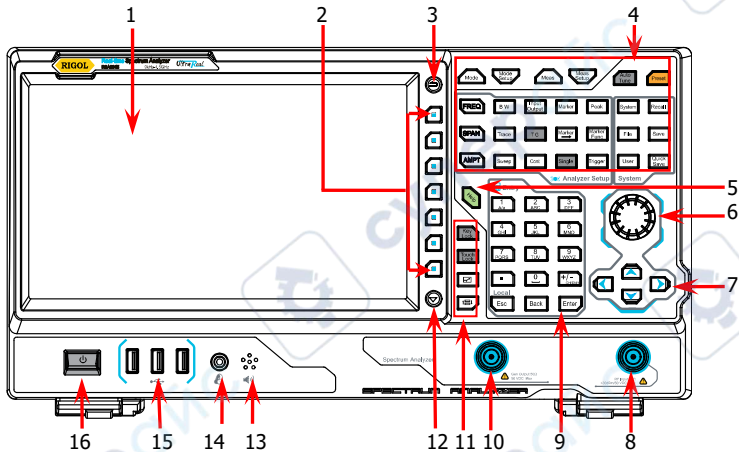

Figure 1 Front Panel

Table 1 Front Panel Description

No.	Description	No.	Description
1	LCD	9	Numeric keyboard
2	Menu softkeys	10	TG output ^[1]
3	Back to previous menu page	11	Utility function key area
4	Function key area	12	Page up/down key
5	Help key	13	Speaker
6	Knob	14	Earphone jack
7	Arrow keys	15	USB HOST
8	RF input	16	Power key

Note^[1]: This function is only available for RSA3015N/RSA3045-TG/RSA3045N/RSA3030-TG/RSA3030N.

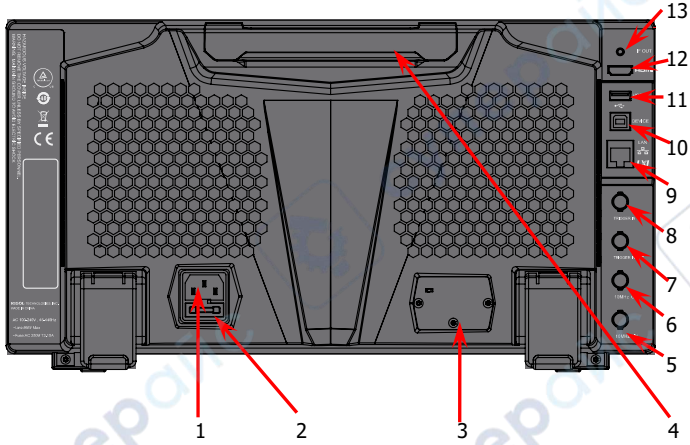

Figure 2 Rear Panel

Table 2 Rear Panel Description











No.	Description	No.	Description
1	AC power cord connector	8	TRIGGER IN
2	Fuse holder	9	LAN
3	OCXO (option)	10	USB DEVICE
4	Handle	11	USB HOST
5	10MHz IN	12	HDMI
6	10MHz OUT	13	IF OUT
7	TRIGGER IN/OUT	—	—



Figure 3 User Interface

Table 3 User Interface^[1] Icons

No.	Name	Description
1	Reference level	Displays the reference level value.
2	Measurement result	Displays the current measurement results for the marker (when no marker exists, the measurement results display center frequency and span).
3	RIGOL	Indicates the company logo.
4	System status	Rmt: indicates remote operation. Ext: indicates the external reference. Uncal: indicates that the measurement has not been calibrated. PA on: indicates that the preamp has been enabled. TG on: indicates that the tracking generator has been enabled.

5	Trace indicator ^[2]	Displays information about the trace and the detector.
6	Information setting	 : indicates messages, such as the prompt messages, alarm messages, and error messages.  : indicates the speaker. You can tune it up and down to increase and decrease the speaker volume, or set it to mute  .  : indicates the network settings. You can configure network parameters.  : unlocks the front panel keys;  : locks the front panel keys.  : unlocks the touch screen;  : locks the touch screen.  : indicates that no USB storage device is inserted;  : indicates that a USB storage device has been inserted.
7	Measurement bar	Displays measurement settings.
8	Measurement function	Displays the currently selected measurement function.
9	Working mode	Displays the currently selected working mode.
10	Function keypad	Clicks the keypad to display the function keypad interface.
11	Active function area	Displays the current parameter and its value.
12	Time	Displays the system time.
13	Menu title	Displays the currently selected menu name.
14	Menu item	Displays the menu item of the current function.
15	Menu page	Shows the current page and the total number of pages for the menu.
16	Sweep time and points	Indicates the sweep time and the number of sweep points in swept mode.
17	Span or stop frequency	The frequency range of the current sweep channel can be expressed by the combination of center frequency and span or the combination of start frequency and stop frequency.
18	Trigger level	Indicates video trigger level.
19	Display line	Indicates the readout reference and the threshold criteria for the peak

20	VBW	Indicates video bandwidth.
21	Spectrum line display area	Indicates the display area for the spectrum line.
22	RBW	Indicates the resolution bandwidth.
23	Center or start frequency	The frequency range of the current sweep channel can be expressed by the combination of center frequency and span or the combination of start frequency and stop frequency.
24	Y scale	Indicates the scale indication in the Y axis.

Note^[1]: For the user interface of the EMI and VNA mode, refer to *EMI User Guide*, and *VNA User Guide*.

Note^[2]: The display of the trace indicator is shown in the following figure:



- The first line displays the trace number. The color of the number is the same as that of the trace.
- The second line displays the trace type, including W (Clear/Write), A (Average), M (Maximum Hold), and m (Minimum Hold). The letters with different colors and in different forms show different meanings.
 - The letter in blue indicates that the trace is updating.
 - The letter in gray indicates that the trace is not updated.
 - The letter with strikethrough and in gray color indicates that the trace will neither be updated nor displayed.
 - The letter with strikethrough and in blue color indicates that the trace is updating but not displayed. It is useful in trace math operation.
- The third line displays the detector type of each trace, including N (Normal, only for GPSA), V (Voltage Average, only for GPSA), P (Positive Peak), p (Negative Peak), S (Sample), R (RMS Average, only for GPSA), Q (Quasi Peak, option, only for GPSA) and A (Average, only for RTSA). If it shows "f", it indicates that it is math operation trace. The letter in blue in the third line (detector type) indicates that the detector is in auto state; the letter in white indicates that it is in manual state.

To Prepare for Use

To Adjust the Supporting Legs

You can unfold the supporting legs to use them as stands to tilt the instrument upwards for easier operation and observation. You can also fold the supporting legs for easier storage or shipment when the instrument is not in use.

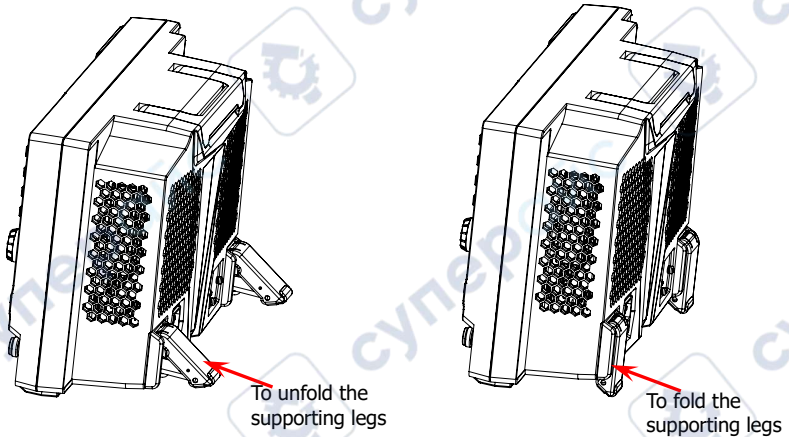
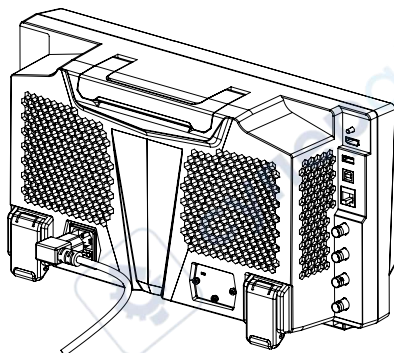

Figure 4 To Adjust the Supporting Legs

To Connect to AC Power

Please use the power cord provided in the accessories to connect the spectrum analyzer to the AC power source. The AC power supply specification of this spectrum analyzer is 100-240 V, 45-440 Hz. The power consumption of the instrument cannot exceed 95 W. When the spectrum analyzer is connected to the AC power source via the power cord, the instrument automatically adapts to the voltage range, and you do not need to select the voltage range manually.

**CAUTION**

To avoid electric shock, ensure that the instrument is correctly grounded.

Turn-on Checkout

After connecting the instrument to the power source properly, press the Power key  on the front panel to start the spectrum analyzer. Then, you will see an initial splash screen. Following the start-up screen which shows the start-up initialization process information, the sweep curve is displayed.

Self-calibration

After the instrument starts, execute self-calibration.

Press **System** → **Alignment** → **Align Now**, and then the instrument will perform self-calibration with the internal calibration source.

To Set the System Language

RSA3000 series spectrum analyzer supports multiple system languages. You can press **System** → **Language** to switch the system language.

Basic Operations

Mouse/Keyboard/Touch Screen Operation Rule

Mouse Operation Rule

Connect the mouse (note that only the left-click operation is supported; the scroll and right-click operations with the mouse are not supported) to the spectrum analyzer via the USB HOST interface to perform the following operations:







1. Click to select the menu and window.
2. Press and hold the left mouse button to drag the data displayed on the graticule or move the slide bar.
3. Double-click the data displayed on the graticule and then the data will be appeared at the right-corner.
4. Under the Marker function, you can only use the mouse to move a marker, but unable to add a marker with the mouse.

Keyboard Operation Rule

Connect the keyboard to the spectrum analyzer via the USB HOST interface, and then use the shortcut keys on the keyboard to perform the same function as what you do with the front panel keys.

Table 4 Matching Relations between the Front Panel Keys and the Keyboard Shortcut Keys

Front Panel Key	Keyboard Shortcut Key ^[1]
Mode	Alt + o
Mode Setup ^[2]	Shift + o
Meas	Alt + e
Meas Setup ^[2]	Shift + e
Auto Tune	Ctrl + Alt + a
Preset	Ctrl + Alt + p
FREQ ^[2]	Shift + f
SPAN ^[2]	Shift + s
AMPT ^[2]	Shift + a
BW ^[2]	Shift + b
Trace ^[2]	Shift + t
Sweep ^[2]	Shift + w

Input Output ^[2]	Shift + i
TG ^[2]	Shift + g
Cont	F11
Marker ^[2]	Shift + m
Marker -> ^[2]	Shift + k
Single	F12
Peak ^[2]	Shift + p
Marker Function ^[2]	Shift + u
Trigger ^[2]	Shift + r
System ^[2]	Shift + y
File	Ctrl + f
User	Ctrl + u
Recall	Ctrl + r
Save	Ctrl + s
Quick save	Ctrl + Alt + q
Help	Alt + F1
	Alt + F2
	Alt + F3
	Alt + F4
	Alt + F5
	Page Up
	Page Down
11 numeric keys	Numeric keys on the keyboard: 10 numeric numbers (1, 2, 3, 4, 5, 6, 7, 8, 9, 0) and a decimal point(.)
+	+
-	-
Esc	Esc
Back	Backspace
Enter	Enter
Arrow keys (Up/Down/Left/Right arrow key)	↑, ↓, ←, →
7 menu softkeys from top to bottom	F1 to F7

Note^[1]: Except the keyboard shortcut keys mentioned in the above table, all the other keys on the keyboard do not work for the menu operation.

Note^[2]: When the Caps Lock key is enabled, every letter you type would be in uppercase, even if you're not holding down the "Shift" key. If disabled, you have to press down "Shift" and the specified letter on the keyboard at the same time to input the letter in uppercase. For example, if you want to execute the Shift+f shortcut key operation, you only need to press "f" on the premise that the Caps Lock key is enabled.

Touch Screen Operation Rule

RSA3000 has a 10.1-inch capacitive multi-touch screen that supports touch gestures.

1. When operating on the menus other than the Marker menu:
 - Tap the trace window, then slide left and right to modify the center frequency; slide up and down to modify the reference level.
 - Stretch two fingers horizontally in the trace window to decrease the span, and pinch the fingers horizontally to increase the span. Stretch two fingers in the vertical direction to decrease the Y-axis scale, and pinch the fingers vertically to increase the Y-axis scale.
2. When operating on the Marker menu:
 - In the empty space of the screen trace region, press and hold the region to add one new marker.
 - Tap and hold one marker to drag the marker.

Menu Operation

There are 6 types of menus according to their operation modes. Each type of menu and its operation method are introduced below.

1. Parameter Input

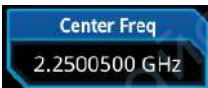

Select the menu and use the numeric keys to modify the value directly. For example, to modify center frequency, first select **Center Freq**, and then input the desired value. Then, press **Enter** to complete parameter input.

2. State Switching

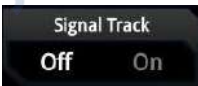

Press the corresponding menu key to switch between the sub-options. For example, press **Signal Track**, and then you can switch between "On" and "Off" to enable or disable the signal tracking function.

3. Enter Lower-level Menu (with parameter)



Press the corresponding menu key to enter the lower-level menu and change the currently selected option. The parameter type in the upper-level menu will be changed when you return to the upper-level menu again. For example, press **Y Axis Unit** to enter the lower-level menu. Select **dBm** and then automatically return to the previous menu. Then, the unit of Y axis will be changed to dBm.

4. Enter Lower-level Menu (without parameter)



Press the corresponding menu key to enter the lower-level menu. For example, press **Peak Config** to enter the lower-level menu directly.

5. Direct Execution



Press the key to execute the corresponding function.

For example, press **Mkr->CF** to set the center frequency of the analyzer to the frequency of the current marker.

6. State Selection



Press the corresponding menu key and modify the parameters, and then go back to the previous menu.

For example, press **Source** → **Free Run** to select free trigger. The analyzer is in Free Run state at present.

Tip:

The above menu operations can be executed by touch gestures or clicking with the externally connected mouse. Also, you can connect to the keyboard and use the shortcut keys to perform the above menu operations. For the matching relations between the front panel keys and the keyboard shortcut keys, refer to Table 4.

Parameter Setting

You can enter the desired parameter values by using the numeric keys, the knob, or arrow keys on the front panel. Also, you can set the parameters by using the touch screen, the keyboard or the mouse. This section takes an example (set the center frequency to 800 MHz) to describe six methods of parameter setting.

1. Use the numeric keys

- 1) Press **FREQ** → **Center Freq**;
- 2) Input 800 using the numeric keys;
- 3) Select the desired unit (MHz) from the pop-up menu.

2. Use the knob

When the parameter is editable, turn the knob clockwise to increase or counterclockwise to decrease the parameter value at the specified step.

- 1) Press **FREQ** → **Center Freq**;
- 2) Rotate the knob until the parameter is set to the desired value (800 MHz).



Figure 5 Knob

3. Use the arrow keys

When the parameter is editable, use the arrow keys to increase or decrease the parameter value at the specific step. Note that the step sizes for the Up/Down arrow key and the Left/Right arrow key are different.

- 1) Press **FREQ** → **Center Freq**;
- 2) Press the Up/Down arrow key or the Left/Right arrow key until the parameter is set to the desired value (800 MHz).

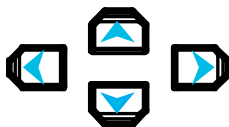



Figure 6 Arrow Keys

4. Use the touch screen

- 1) Touch the screen to select the function keypad icon  at the upper-right corner. Then, the function keypad is displayed. Touch "FREQ";
- 2) Click **Center Freq**;
- 3) Then the numeric keypad is displayed. Input 800, and select the desired unit "MHz".

5. Use the keyboard

- 1) Press "Shift + f" to open the Frequency menu;
- 2) Press "F1" to select **Center Freq**;
- 3) Input 800 by using the numeric keys;
- 4) Press "F2" to select the desired unit (MHz) from the pop-up menu.

For the matching relations between the front panel keys and the keyboard shortcut keys, refer to Table 4.

6. Use the mouse

- 1) Click with the mouse to select the function keypad icon  at the upper-right corner of the screen. Then, the function keypad is displayed. Click "FREQ";
- 2) Click **Center Freq**;
- 3) Then the numeric keypad is displayed. Input 800, and select the desired unit "MHz".

To Use the Built-in Help System

The built-in help system provides information about every function key on the front panel and every menu softkey.

1. Get the built-in help information

Press **Help** and a prompt message about how to obtain help information will be shown on the screen. Then, press the key that you want to know about its usage, and then the relevant help information for the key will be shown on the screen.

2. Page up/down operation

If the help information is displayed in several pages, you can press the arrow keys or use the knob to page up and down the help information.

3. Close the current help information

When the help information is displayed on the screen, perform any one of the following operations to close the currently displayed help information dialog box:

- press **Esc**;
- press the **Help** key again;
- click "Ok" in the displayed help information dialog box.

4. Get the help information of the menu key

Press **Help**, and the help information display window is displayed on the screen. Then, press the menu key and the help information of the corresponding menu item is displayed.

5. Get the help information of any function key

Press **Help**, and the help information display window is displayed on the screen. Then, press any function key and the corresponding function help information is displayed.

Fuse Replacement

If you need to replace the fuse, use only the specified fuse (AC 250 V, T3.15 A) and perform the following operations:

1. Turn off the instrument, cut off the power, and remove the power cord.
2. Use a small straight slotted screwdriver to pry out the fuse holder.
3. Take out the fuse.
4. Replace the old fuse with a specified fuse.
5. Install the fuse holder.

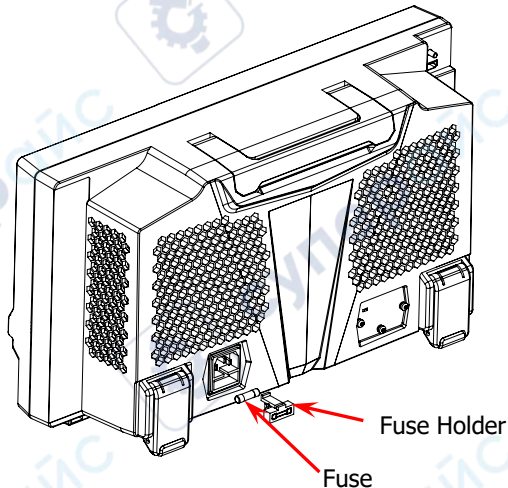

Figure 8 Fuse Replacement



WARNING

To avoid electric shock, please ensure that the instrument has been turned off, the power source has been cut off, and the fuse to be used conforms to the fuse rating.

Working Mode Setting

RSA3000 provides four working modes: GPSA, RTSA, EMI (option) and VNA. Press **Mode** to select the working mode.

Note: In different working modes, the functions of the keys on the front panel may be different. Press **Help** to display the help information of the current working mode. If you need help information for other modes, exit the help interface first. Then select the desired working mode and obtain the corresponding help information.

1. GPSA

GPSA adopts two analysis methods: swept and FFT. GPSA can not only carry out frequency domain analysis, but also time domain (zero span) analysis.

Select GPSA. In this working mode, you can press **Meas** to select multiple measurements.

2. RTSA

RTSA provides the real-time signal analysis function, which can capture the complex signal seamlessly.

Select RTSA. In this working mode, you can press **Meas** to select multiple measurements.

3. EMI

EMI mode provides the EMI pre-compatibility measurement function. If you need this function, please purchase this option (order No. RSA3000-EMI), and install it according to instructions in "**Install the Option**".

4. VNA

VNA mode provides the vector network analyzer function. It provides S11, S21, and DTF measurements. In this working mode, you can press **Meas** to select the desired measurement.

You can also press **Mode Setup** (disabled in VNA mode) to open the global parameter setting menu for the selected working mode under **Mode**.

Install the Option

RSA3000 provides various options to expand the function of the spectrum analyzer. If you need to purchase the option, please contact **RIGOL** sales representative. After you have purchased the option successfully, you will get the corresponding key. Then perform the following operations to install the option.

1. Acquire the License of the Option

- Log in to the **RIGOL** official website (www.rigol.com), click **License Activation** to enter the "Registered product license code" interface.
- Input the correct key, serial number (press **System** → **About System** → **System Info** to acquire the serial number of the instrument), and verification code. Click **Generate** to acquire the option license. In the license generation interface, click **Download** to download and save the license file to the PC.

2. Install the Option

You can install the option via the following 2 methods.

- 1) Install the option by reading the license file from the USB storage device
 - Copy the saved option license file to the root directory of the USB storage device.
 - Power on the instrument and insert the USB storage device. Press **File** to enter the file operation menu interface.
 - Press **File Explorer**, and then the file manager interface is displayed. In the interface, find the directory of the USB storage device. Then select the desired option license file (suffixed with ".lic"). Press **Import License** to import the activation code and complete the reading of the option installation file.
- 2) Install the option by sending SCPI Commands
 - Log in to **RIGOL** official website (www.rigol.com) to download the software Ultra Sigma. Then install it according to the installation wizard.
 - Use the USB cable to connect the rear-panel USB DEVICE interface of RSA3000 to the USB HOST interface of the PC.
 - Run Ultra Sigma. Search the resource and right-click the resource name. In the displayed menu, select "SCPI Panel Control". Input the following option installation command in the

displayed SCPI control panel: `:SYSTem:LKEY <option info>@<license info>`. Wherein, `<option info>` indicates the option order No., and `<license info>` indicates the option license code.

For example, the following command is used to install the option RSA3000-PA.

```
:SYSTem:LKEY  
RSA3000-PA@8AD12B8EBC5DF492D1D4289B7CBA5B6150BF6  
F5D752D645C36D74530B05F39B49C461B23A50D6C94A34E0  
6782AC4380070B0D1A86BA84E02768391FFD70C2103
```

Remote Control

RSA3000 can be connected to the PC via the USB or LAN interface to set up communication and realize remote control through the PC. The remote control can be realized by using SCPI (Standard Commands for Programmable Instruments) commands. The RSA3000 series spectrum analyzer supports two ways of remote control: user-defined programming and PC software (e.g. **RIGOL** Ultra Sigma).

When the instrument is in remote control, the keys (except the Power key  and **Esc**) on the front panel are locked. At this time, you can press **Esc** to exit the remote mode.

More Product Information

Obtain the device information

Press **System** → **About System** to view the device information and the installation status of all the options.

For more information about this instrument, refer to the relevant manuals by logging in to the official website of **RIGOL** (www.rigol.com) to download them.

RSA3000 User Guide: introduces the functions of the instrument and the operation methods in GPSA and RTSA modes, remote control methods, possible failures and solutions in using the instrument, and order information.

RSA3000 Programming Guide: provides detailed descriptions of SCPI commands in GPSA and RTSA modes and programming instances of the instrument.

RSA3000 Datasheet: provides the main features and technical specifications of the instrument.

EMI User Guide: introduces the functions of the instrument and the operation methods in EMI mode, and order information.

EMI Programming Guide: provides detailed descriptions of SCPI commands in EMI mode.

VNA User Guide: introduces the functions of the instrument and the operation methods in VNA mode, and order information.

VNA Programming Guide: provides detailed descriptions of SCPI commands in VNA mode.

RIGOL

快速指南

中文

RSA3000 系列实时频谱分析仪

2020 年 7 月

RIGOL TECHNOLOGIES CO., LTD



保证和声明

版权

© 2020 普源精电科技股份有限公司

商标信息

RIGOL®是普源精电科技股份有限公司的英文名称和商标。

中文

文档编号

QGD21003-1110

声明

- 公司产品受中国及其它国家和地区的专利（包括已取得的和正在申请的专利）保护。
- 本公司保留改变规格及价格的权利。
- 本手册提供的信息取代以往出版的所有资料。
- 本手册提供的信息如有变更，恕不另行通知。
- 对于本手册可能包含的错误，或因手册所提供的信息及演绎的功能以及因使用本手册而导致的任何偶然或继发的损失，**RIGOL** 概不负责。
- 未经 **RIGOL** 事先书面许可，不得影印、复制或改编本手册的任何部分。

产品认证

RIGOL 认证本产品符合中国国家产品标准和行业产品标准及 ISO9001:2015 标准和 ISO14001:2015 标准，并进一步认证本产品符合其它国际标准组织成员的相关标准。

联系我们

如您在使用此产品或本手册的过程中有任何问题或需求，可与 **RIGOL** 联系：

电子邮箱：service@rigol.com

网址：www.rigol.com

一般安全概要

1. 请使用所在国家认可的本产品专用电源线。
2. 请确保产品可靠接地。
3. 查看所有终端额定值。
4. 请使用合适的过压保护。
5. 请勿开盖操作。
6. 请勿将异物插入排风口。
7. 请使用合适的保险丝。
8. 避免电路外露。
9. 怀疑产品出故障时，请勿进行操作。
10. 请保持适当的通风。
11. 请勿在潮湿环境下操作。
12. 请勿在易燃易爆的环境下操作。
13. 请保持产品表面的清洁和干燥。
14. 请注意防静电保护。
15. 请注意搬运安全。

安全术语和符号

本手册中的安全术语：



警告

警告性声明指出可能会造成人身伤害或危及生命安全的情况或操作。



注意

注意性声明指出可能导致本产品损坏或数据丢失的情况或操作。

产品上的安全术语：

DANGER
WARNING
CAUTION

表示您如果不进行此操作，可能会立即对您造成危害。

表示您如果不进行此操作，可能会对您造成潜在的危害。

表示您如果不进行此操作，可能会对本产品或连接到本产品的其他设备造成损坏。

产品上的安全符号：



高电压



安全警告



保护性接地端



壳体接地端



测量接地端

保养与清洁

保养

请勿将仪器放置在长时间受到日照的地方。

清洁

请根据使用情况定期对仪器进行清洁。方法如下：

1. 断开电源。
2. 用柔和的清洁剂或清水浸湿软布擦拭仪器外部。清洁带有液晶显示屏的仪器时，请注意不要划伤 LCD 显示屏。



注意

请勿使任何腐蚀性的液体沾到仪器上，以免损坏仪器。



警告

重新通电之前，请确认仪器已经干透，避免因水分造成电气短路甚至人身伤害。

文档概述

本文档介绍初次使用RSA3000系列频谱分析仪时需要了解的信息，包括开箱检查方法、产品简介、连接电源、开机检查等具体步骤以及远程控制概述等。

提示

本手册的最新版本可登录 **RIGOL** 网址 (www.rigol.com) 进行下载。

文档格式的约定

1. 按键：

本手册中通常用“文本框+文字（加粗）”表示前面板上的一个按键，如 **FREQ** 表示 **FREQ** 键。

2. 菜单：

本手册中通常用“字符底纹+文字（加粗）”表示一个菜单，如 **中心频率** 表示 **FREQ** 功能键的中心频率菜单。

3. 连接器：

本手册中通常用“方括号+文字（加粗）”表示前面板或后面板上的一个连接器，如 **[Gen Output 50Ω]**。

4. 操作步骤：

本手册中通常用箭头“→”表示下一步操作，如 **FREQ** → **中心频率** 表示按下前面板上的 **FREQ** 功能键后再按 **中心频率** 菜单软键。

文档内容的约定

RSA3000系列频谱分析仪包含以下型号。如无特殊说明，本手册以RSA3045-TG为例说明RSA3000系列及其基本操作。

型号	频率范围	跟踪源
RSA3045	9 kHz 至 4.5 GHz	无
RSA3030	9 kHz 至 3 GHz	无
RSA3045-TG	9 kHz 至 4.5 GHz	4.5 GHz
RSA3045N	9 kHz 至 4.5 GHz	4.5 GHz
RSA3030-TG	9 kHz 至 3 GHz	3 GHz
RSA3030N	9 kHz 至 3 GHz	3 GHz
RSA3015N	9 kHz 至 1.5 GHz	1.5 GHz

注：RSA3000N 型号是 RSA3000-TG 型号的升级版本，标配 TG 功能。

仅 RSA3000N 型号支持矢量网络分析（VNA）工作模式。

一般性检查

1. 检查运输包装

如运输包装已损坏，请保留被损坏的包装或防震材料，直到货物经过完全检查且仪器通过电性和机械测试。

因运输造成仪器损坏，由发货方和承运方联系赔偿事宜。**RIGOL**公司恕不进行免费维修或更换。

中文

2. 检查整机

若存在机械损坏或缺失，或者仪器未通过电性和机械测试，请联系您的**RIGOL**经销商。

3. 检查随机附件

请根据装箱单检查随机附件，如有损坏或缺失，请联系您的**RIGOL**经销商。

产品简介

RSA3000 系列是一款高性价比的新一代实时频谱分析仪，它拥有优异的性能指标、清晰的用户界面，支持前面板按键、触摸屏、外接鼠标和键盘操作等功能，提供远程通信接口，可广泛应用于教育科学、企业研发和工业生产等诸多领域中。

前面板、后面板和主界面（显示屏）的简要介绍请分别参考图 1、图 2 和图 3。



图 1 前面板

表 1 前面板说明

编号	说明	编号	说明
1	LCD 显示屏	9	数字键盘
2	菜单软键	10	跟踪源输出 ^[1]
3	返回上次操作的菜单页	11	辅助功能键区
4	功能键区	12	菜单翻页键
5	帮助键	13	扬声器
6	旋钮	14	耳机插孔
7	方向键	15	USB HOST 接口
8	射频输入	16	电源开关键

注^[1]：此功能仅适用于 RSA3015N、RSA3045-TG/N 和 RSA3030-TG/N。

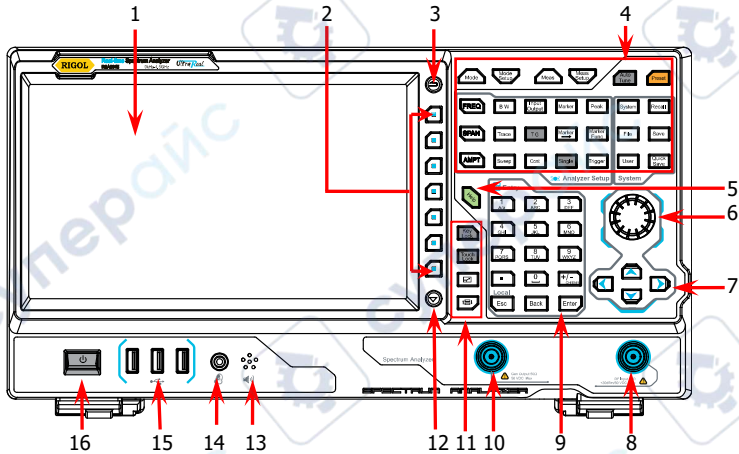
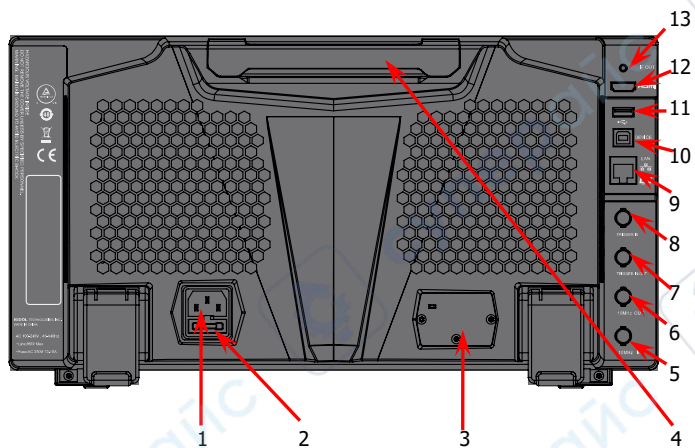

中文

图 2 后面板

表 2 后面板说明

编号	说明	编号	说明
1	AC 电源连接器	8	TRIGGER IN
2	保险丝座	9	LAN 接口
3	OCO (选件)	10	USB DEVICE 接口
4	手柄	11	USB HOST 接口
5	10MHz IN	12	HDMI 接口
6	10MHz OUT	13	IF OUT
7	TRIGGER IN/OUT	---	---



图 3 用户界面

表 3 用户界面^[1]标识

编号	名称	说明
1	参考电平	参考电平值。
2	测量结果	显示光标当前测量结果（无光标时，显示中心频率和扫宽值）。
3	RIGOL	公司商标。
4	系统状态	Rmt: 远程操作。Ext: 外部参考。 Uncal: 测量未校准。PA on: 打开前置放大。 TG on: 打开跟踪源。
5	迹线指示器 ^[2]	显示迹线和检波器信息。
6	信息设置	<ul style="list-style-type: none"> : 消息，显示信息、警告和错误消息。 : 扬声器控制，增大或减小扬声器音量，或静音 : 网络设置，设置网络参数。 : 解锁前面板按键；: 锁定前面板按键。 : 解锁触摸屏；: 锁定触摸屏。 : 未插入 U 盘；: 插入 U 盘。

7	测量条	显示测量设置信息。
8	测量功能	显示当前选择的测量功能。
9	工作模式	显示当前选择的工作模式。
10	功能键盘	点击弹出功能键盘界面。
11	活动功能区	当前操作的参数及参数值。
12	时间	显示系统时间。
13	菜单标题	当前菜单所属的功能。
14	菜单项	当前功能的菜单项。
15	菜单页号	显示菜单当前页号以及总页数。
16	扫描时间和点数	扫频的扫描时间和扫描点数。
17	扫宽或终止频率	当前扫频通道的频率范围可以用中心频率和扫宽，或者起始频率和终止频率表示。
18	触发电平	视频触发电平。
19	显示线	读数参考以及峰值显示的阈值条件。
20	VBW	视频带宽。
21	谱线显示区域	谱线显示区域。
22	RBW	分辨率带宽。
23	中心频率或起始频率	当前扫频通道的频率范围可以用中心频率和扫宽，或者起始频率和终止频率表示。
24	Y轴刻度	Y轴的刻度标注。

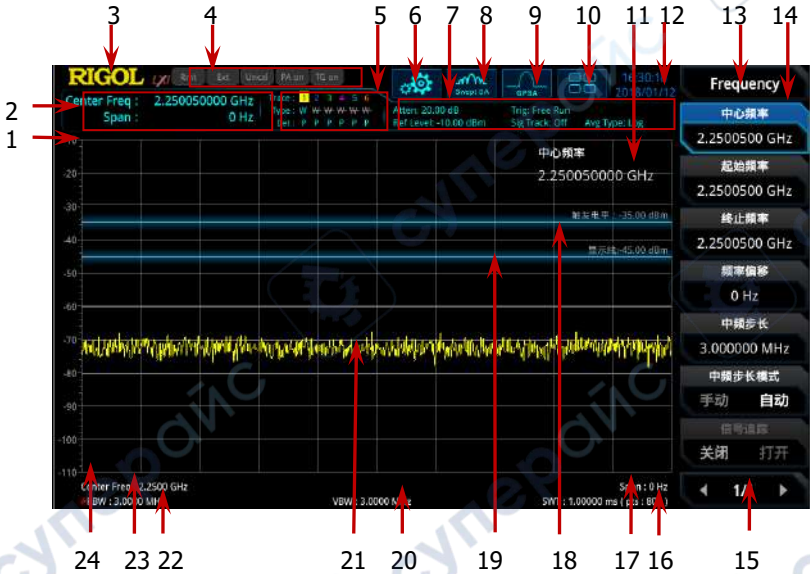
注[1]：EMI、VNA 模式的用户界面详情，请参考《EMI 用户手册》和《VNA 用户手册》。

注[2]：迹线指示器显示如下图所示，



- 第一行显示迹线序号，数字颜色与迹线颜色一致。
- 第二行显示对应的迹线类型，包括 W（清除/重写）、A（平均）、M（最大保持）和 m（最小保持）。不同的字母显示模式含义如下：
 - 字母显示蓝色，则表示迹线正在被更新；
 - 字母显示灰色，则表示迹线不会被更新；
 - 字母显示灰色且有删除线，则表示迹线不会被更新和显示；
 - 字母显示蓝色且有删除线，则表示迹线正在被更新但没有显示；这种情况对迹线数学运算很有用。
- 第三行显示每条迹线的检波器类型，包括 N（标准，仅 GPSA 模式）、V（电压平均，仅 GPSA 模式）、P（正峰值）、p（负峰值）、S（抽样）、R（有效值平均，仅 GPSA 模式）、Q（准峰值，选件，仅 GPSA 模式）、A（均值，仅 RTSA 模式）；显示“f”则表示迹线是数学运算迹线。若检波器字母是蓝色，则表示检波器处于自动状态；若是白色，则表示处于手动状态。

使用前准备

调整支撑脚

中文

RSA3000 允许用户在使用仪器时打开支撑脚以作为支架使仪器向上倾斜，便于操作和观察。在不使用仪器时，用户可以合上支撑脚以方便放置或搬运。



图 4 调整支撑脚

连接电源

请使用附件提供的电源线将频谱分析仪连接至 AC 电源中。本频谱分析仪支持 100-240 V, 45-440 Hz 规格的交流电源。仪器最大功耗不超过 95 W。当通过电源线将频谱分析仪连接到交流电源时，仪器自动适应该电压范围，无需手动选择电压范围。

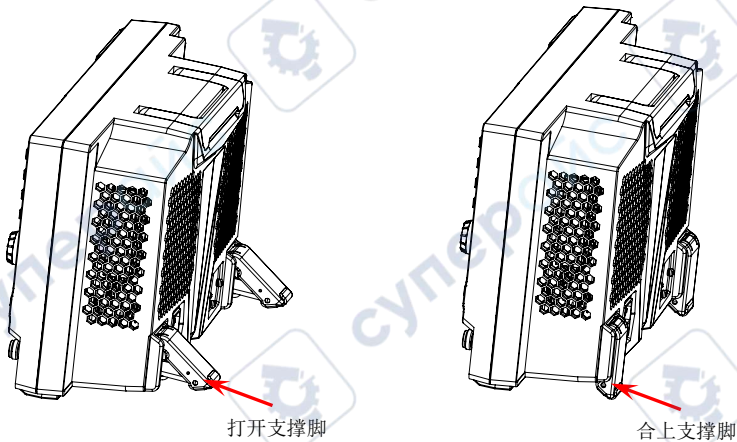
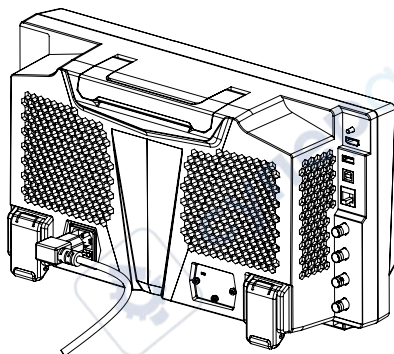

注意
为避免电击，请确保仪器正确接地。

开机检查

正确连接电源后，按下前面板的电源开关键  打开频谱分析仪。开机画面显示开机初始化过程信息。结束后，屏幕出现扫频曲线。

执行自校准

开机完成，请执行自校准。

按 **System** → **校准设置** → **立即校准**，使用系统内部的校准源对系统进行自校准。

设置系统语言

RSA3000 系列频谱分析仪支持多种系统语言，您可以按 **System** → **语言设置** 切换系统语言。

基本操作

鼠标/键盘/触摸屏操作规则

鼠标操作规则

您可以通过 USB HOST 接口将鼠标连接至频谱分析仪(注意,仅支持鼠标左键操作;不支持滚轮及鼠标右键),执行以下操作:







1. 单击选择菜单及窗口。
2. 长按左键可拖动网格上的显示数据或滑动条。
3. 双击网格上的显示数据,数据回到右上角。
4. 在Marker功能下,鼠标只支持移动光标,不支持增加光标。

键盘操作规则

您可以通过 USB HOST 接口将键盘连接至频谱分析仪,然后通过键盘快捷键代替仪器前面板按键执行相应操作。

表 4 前面板按键与键盘快捷键关系

前面板按键	键盘快捷键 ^[1]
Mode	Alt + o
Mode Setup ^[2]	Shift + o
Meas	Alt + e
Meas Setup ^[2]	Shift + e
Auto Tune	Ctrl + Alt + a
Preset	Ctrl + Alt + p
FREQ ^[2]	Shift + f
SPAN ^[2]	Shift + s
AMPT ^[2]	Shift + a
BW ^[2]	Shift + b
Trace ^[2]	Shift + t
Sweep ^[2]	Shift + w
Input Output ^[2]	Shift + i
TG ^[2]	Shift + g
Cont	F11
Marker ^[2]	Shift + m
Marker -> ^[2]	Shift + k
Single	F12

Peak ^[2]	Shift + p
Marker Func ^[2]	Shift + u
Trigger ^[2]	Shift + r
System ^[2]	Shift + y
File	Ctrl + f
User	Ctrl + u
Recall	Ctrl + r
Save	Ctrl + s
Quick save	Ctrl + Alt + q
Help	Alt + F1
	Alt + F2
	Alt + F3
	Alt + F4
	Alt + F5
	Page Up
	Page Down
11 个数字键	键盘数字键 (1, 2, 3, 4, 5, 6, 7, 8, 9, 0, .)
+	+
-	-
Esc	Esc
Back	Backspace
Enter	Enter
上、下、左、右方向键	↑、↓、←、→
第一至第七个菜单软键 (从上到下)	F1 至 F7

注^[1]: 除上述表格中提到的键盘快捷键外, 其余键盘按键均无效。

注^[2]: 若外接键盘打开大写锁定 (Caps Lock), 其功能等同于按下 Shift 键。因此, 所有通过“Shift+字母”键盘快捷键执行的功能, 在打开大写锁定 (Caps Lock) 时, 只需按下相应的键盘“字母”即可。例如, 如需执行 Shift+f 快捷键, 则在打开大写锁定 (Caps Lock) 时, 按 f 键即可。

触摸屏操作规则

RSA3000 提供 10.1 英寸多点触摸屏, 支持多种手势操作。

1. 非 Marker 菜单时:

- 单手指在迹线窗口左右滑动修改中心频率; 上下滑动修改参考电平。
- 两手指在迹线窗口横向分开手指减小扫宽, 合并手指增大扫宽; 纵向分开手指减小 Y 轴刻度, 合并手指增大 Y 轴刻度。

2. 进入Marker菜单时:

- 在屏幕迹线区空白处单手指长按，可添加一个新光标。
- 单手指按住一个光标，可拖动该光标。

菜单操作

中文

菜单类型按执行方式的不同可分为6种，下面将详细介绍每种类型及其操作方法。

1. 参数输入型



按相应的菜单，可直接使用数字键输入数字改变参数值。

例如：选中 **中心频率**，通过数字键输入数字后，按 **Enter** 键即可改变中心频率。

2. 状态切换



按相应的菜单键，可切换菜单项的子选项。

例如：按 **信号追踪**，可在打开/关闭信号追踪功能之间切换。

3. 进入下一级菜单（带参数）



按相应的菜单键，进入当前菜单的下一级子菜单，改变子菜单的选中项，在返回时会改变父菜单所带参数的类型。

例如：按 **Y轴单位** 进入下一级子菜单，选中 **dBm** 后，自动返回上层菜单，即改变Y轴单位为dBm。

4. 进入下一级菜单（不带参数）



按相应的菜单键，进入当前菜单的下一级子菜单。

例如：按 **搜索参数**，直接进入下一级菜单。

5. 直接执行此功能



按相应的菜单键，执行一次对应的功能。
例如：按 **光标->中频**，设置频谱仪的中心频率为当前光标处的频率。

6. 选中状态

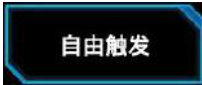

按相应的菜单键，修改参数后返回上级菜单。
例如：按 **触发源** → **自由触发** 选中自由触发，表明此时频谱仪处于自由触发状态。

中文

提示：

上述菜单操作均可使用外接鼠标或触摸屏手势操作实现。另外，您也可使用外接键盘快捷键（前面板按键与键盘快捷键对应关系请参考表 4）执行上述菜单操作。

参数设置

参数输入可通过前面板数字键盘、旋钮或方向键完成，也可以使用触摸屏或外接键盘、鼠标设置。本节以一个例子介绍六种参数设置方法（设置中心频率为 800 MHz）。

1. 使用数字键盘

- 1) 按 **FREQ** → 中心频率；
- 2) 使用数字键盘输入数值“800”；
- 3) 在弹出的单位菜单中选择所需的单位“MHz”。

2. 使用旋钮

在参数可编辑状态，旋转旋钮将以指定步进增大（顺时针）或减小（逆时针）参数。

- 1) 按 **FREQ** → 中心频率；
- 2) 旋转旋钮直到获得所需的参数值（800 MHz）。



图 5 旋钮

3. 使用方向键

在参数可编辑状态下，方向键可用于按一定的步进递增或递减参数值。注意，上/下方向键和左/右方向键各自的步进不同。

- 1) 按 **FREQ** → 中心频率；
- 2) 按上/下方向键或左/右方向键直到获得所需的参数值（800 MHz）。

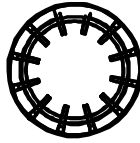



图 6 方向键

4. 使用触摸屏

- 1) 用手指点击触摸屏右上角的功能键盘标识 ，在弹出的功能键盘中点击 **FREQ**；
- 2) 点击 中心频率 菜单；
- 3) 使用弹出的数字键盘输入 800，并选择所需单位“MHz”。

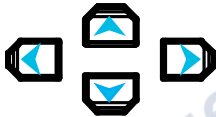
5. 使用外接键盘

- 1) 按“Shift + f”打开 Frequency 菜单；
- 2) 按“F1”选中 中心频率；
- 3) 使用数字键输入数值“800”；
- 4) 按“F2”在弹出的单位菜单中选择所需的单位“MHz”。

仪器前面板按键与键盘快捷键的对应关系请参考表 4。

6. 使用外接鼠标

- 1) 用外接鼠标点击仪器屏幕右上角的功能键盘标识 ，在弹出的功能键盘中点击 **FREQ**；
- 2) 点击 中心频率 菜单；
- 3) 使用弹出的数字键盘输入 800，并选择所需单位“MHz”。

使用内置帮助系统

RSA3000 内置帮助系统提供了前面板上各功能按键及菜单软键的帮助信息。

1. 获取内置帮助的方法

按下 **Help** 键，屏幕中央将弹出如何获取帮助的提示。再按下希望获取帮助的按键，屏幕中央将出现该键的帮助信息。

中文

2. 帮助的翻页操作

当帮助信息为多页显示时，通过方向键或旋钮可获得上一页或下一页的帮助信息。

3. 关闭当前的帮助信息

当屏幕中显示帮助信息时，执行以下任何一项操作则可关闭当前显示的帮助信息框：

- 按下 **Esc** 键；
- 再次按下 **Help** 键；
- 点击帮助信息框中的“确定”按钮。

4. 获取菜单按键的帮助信息

按下 **Help** 键，屏幕中央将弹出帮助信息显示窗口。按下菜单键，显示窗口将显示菜单键所对应菜单项的帮助信息。

5. 获取任意功能按键的帮助信息

按下 **Help** 键，屏幕中央将弹出帮助信息显示窗口。按下任意功能键，显示窗口将显示按键本身的功能帮助信息。

更换保险丝

如需更换保险丝，请使用仪器指定规格（AC 250 V，T3.15 A）的保险丝，按如下步骤更换：

1. 关闭仪器，断开电源，拔去电源线；
2. 使用小一字螺丝刀撬出保险丝座；
3. 取出保险丝；
4. 更换指定规格的保险丝；
5. 重新安装保险丝座。



图 8 更换保险丝



警告

为避免电击，更换保险丝之前，请确保仪器已关闭并且已断开与电源的连接，且确保更换的保险丝规格符合要求。

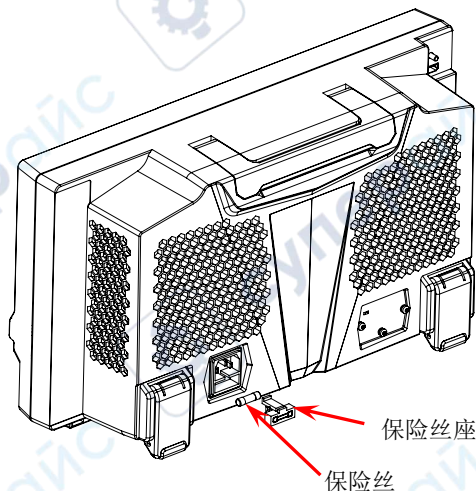
工作模式设置

RSA3000 提供四种工作模式，包括：GPSA、RTSA、EMI（选件）和 VNA。您可按 **Mode** 键进行选择。

注意：在不同的工作模式下，前面板按键操作可能不同。按 **Help** 键显示当前工作模式的帮助信息。若需获取其他模式下的帮助信息，请退出帮助界面，再选择所需的工作模式重新获取帮助信息。

中文

1. GPSA

GPSA 模式采用扫频和 FFT 两种分析方法。GPSA 既可以完成频域分析，也可以完成时域（零扫宽）分析。

选择通用测量的频谱分析仪模式。在该模式下，您可通过 **Meas** 菜单选择多种测量。

2. RTSA

RTSA 模式提供了实时信号分析功能，可实现无缝捕捉复杂信号。

选择实时测量的频谱分析仪模式。在该模式下，您也可通过 **Meas** 菜单选择多种测量。

3. EMI

EMI 模式提供了 EMI 预兼容测量功能。如需使用该功能，请购买该选件（订货号 RSA3000-EMI），参考“**安装选件**”一节说明进行安装。

4. VNA

VNA 模式提供了矢量网络分析功能，可进行 S11、S21 和 DTF 的测量。在 VNA 模式下，您可通过 **Meas** 菜单选择测量方式。

另外，按 **Mode Setup** 键，您可打开当前 **Mode** 功能键中所选工作模式（GPSA、RTSA、EMI）对应的全局参数设置菜单。

安装选件

RSA3000 提供多种选件，用于扩展频谱分析仪的功能。如需购买选件请联系 RIGOL 经销商。订购成功后，您将获得相应的密钥，然后按照如下操作，您可以完成选件的安装。

1. 获取选件授权码 (license)

- 登录 RIGOL 官网(www.rigol.com)后,单击 **产品与服务** → **服务** → **产品授权码注册**, 进入软件授权码注册界面。
- 在软件授权码注册界面中输入正确的密钥、仪器序列号(按 **System** → **关于系统** → **系统信息**, 即可获取设备序列号)和验证码, 点击 **生成** 即可获取选件授权码 (license)。在软件授权码生成界面点击 **下载** 则可保存授权文件至计算机。

2. 安装选件

您可以通过如下 2 种方式安装选件。

1) 通过读取 U 盘中的授权文件安装选件

- 将已保存的选件授权文件复制到 U 盘根目录。
- 开机并插入 U 盘后, 按 **File** 键进入文件操作菜单界面。
- 按 **文件浏览器** 软键, 在弹出的文件管理器界面切换至 U 盘目录, 选择所需的选件授权文件 (.lic), 按 **导入激活码** 软键执行导入操作, 完成选件安装文件的读取。

2) 通过发送 SCPI 命令安装选件

- 登录 RIGOL 官网 (www.rigol.com) 下载 Ultra Sigma, 然后按照安装向导进行安装。
- 使用 USB 数据线连接 RSA3000 后面板 USB DEVICE 接口和计算机的 USB HOST 接口。
- 运行 Ultra Sigma, 搜索资源并右击资源名称, 在弹出的菜单中选择 “SCPI Panel Control”。在弹出的 SCPI 控制面板中输入如下选件安装命令 :[:SYSTem:LKEY <option info>@<license info>](#)。其中, [<option info>](#) 表示选件订货号, [<license info>](#) 表示选件授权码 (license)。

例如: 下面的命令安装选件 RSA3000-PA。

```
:SYSTem:LKEY  
RSA3000-PA@8AD12B8EBC5DF492D1D4289B7CBA5B6150BF6  
F5D752D645C36D74530B05F39B49C461B23A50D6C94A34E0  
6782AC4380070B0D1A86BA84E02768391FFD70C2103。
```

远程控制

RSA3000 系列支持通过 USB、LAN 接口与计算机进行通信从而实现远程控制。远程控制基于 SCPI (Standard Commands for Programmable Instruments) 命令集实现。RSA3000 系列频谱仪支持两种远程控制方式：用户自定义编程和使用 PC 软件 (如 **RIGOL Ultra Sigma**)。

中文

当仪器处于远程控制状态时，前面板按键被锁定 (电源开关键  和 **Esc** 键除外)。此时，您可以按 **Esc** 退出远程模式。

更多产品信息

获取设备信息

按 **System** → **关于系统**，您可获取设备信息和查看所有选件的安装状态。

欲了解本产品更多信息，请查阅相关手册 (您可登录 **RIGOL** 网站 www.rigol.com 下载)。

《RSA3000 用户手册》：提供本产品 in GPSA 和 RTSA 模式的功能介绍及操作方法、远程控制方法、在使用过程中可能出现的故障及处理方法，以及订货信息；

《RSA3000 编程手册》：提供本产品 in GPSA 和 RTSA 模式的 SCPI 命令集，以及编程实例；

《RSA3000 数据手册》：提供本产品的主要特色和技术指标；

《EMI 用户手册》：提供本产品 in EMI 模式的功能介绍和操作方法，以及订货信息；

《EMI 编程手册》：提供本产品 in EMI 模式的 SCPI 命令集。

《VNA 用户手册》：提供本产品 in VNA 模式的功能介绍和操作方法，以及订货信息；

《VNA 编程手册》：提供本产品 in VNA 模式的 SCPI 命令集。