User Manual

SDM3045X Digital Multimeter

UM06034-E01A

2016 SIGLENT TECHNOLOGIES CO., LTD



Copyright and Statement

Copyright

SIGLENT TECHNOLOGIES CO., LTD. All rights reserved.

Trademark Information

SIGLENT is registered trademark of SIGLENT TECHNOLOGIES CO., LTD.

Statement

- **SIGLENT** products are protected by patent laws in and outside of the P.R. China.
- **SIGLENT** reserves the rights to change the specification and price.
- Information in this publication replaces all previous corresponding published material.
- Contents in this manual are not allowed to be copied, extracted or translated in any form or by any means without **SIGLENT**'s permission.

General Safety Summary

Read the following safety precautions carefully to avoid any personal injuries or damages to the instrument and any products connected to it. To avoid potential hazards, please use the instrument as specified.

Use proper power line.

It's only allowed to use the special power line which is approved by local state.

Ground the instrument.

The instrument is grounded through the protective terra conductor of the power line. The ground conductor must be connected to the earth to avoid electric shock. Make sure the instrument is grounded correctly before connecting its input or output terminals.

Connect the signal wire correctly

The potential of the signal wire is equal to the earth, so do not connect the signal wire to a high voltage.

Observe all terminal ratings

Please observe all ratings and sign instructions on the instrument to avoid fire or electric shock. Before connecting the instrument, please read the manual carefully to gain more information about the ratings.

Do not operate with suspected failures

If you suspect that the product is damaged, please contact SIGLENT's qualified service personnel to inspect it. Any repair and adjustment to the product or replacing a component should be done by qualified personnel only.

Avoid circuit or wire exposure

Don't touch exposed contacts or components when the power is on.

Don't operate without covers.

Don't operate the instrument with covers or panels removed.

Use proper fuse.

It's only allowed to use the specified fuse for the instrument.

Use proper over-voltage protection.

Make sure there is no over-voltage (like voltage caused by thunder and lightning) reaching to the instrument, otherwise the operator may suffer an electric shock.

Antistatic protection.

Static electricity will cause damages to the instrument, so test in antistatic areas as far as possible. Ground its inner and outer conductors to release the static electricity temporarily before connecting the cable to the instrument.

Keep good ventilation.

Improper ventilation will cause the rise of the instrument's temperature. Keep good ventilation and check the vent and fan regularly when using it.

Keep the surface of the instrument clean and dry.**Do not operate in wet or damp conditions.****Do not operate in flammable or explosive environment.**

The disturbance test of all the models meets the limit values of A in the standard of EN 61326-1:2013.

Input terminal protection limitation

Protection limitation is defined for the input terminal:

1. Main input (HI and LO) terminal

HI and LO terminals are used for Voltage, Resistance, Capacitance, Continuity, Frequency and Diode measurement. Two protection limitations are defined:

- **HI-LO protection limitation:** 1000VDC or 750AVC. It's the maximum measurable voltage. The limitation can be expressed as 1000Vpk.
- **LO-ground protection limitation:** LO terminal can "float" 500Vpk relative to the ground safely. The maximum protection limitation of HI terminal relative to the ground is 1000Vpk. Therefore, the sum of the "float" voltage and the measured voltage can't exceed 1000Vpk.

2. Sampling (HI Sense and LO Sense) terminal

HI Sense and LO Sense are used for 4-wire Resistance measurement. Two protection limitations are defined:

- **HI Sense-LO Sense protection limitation:** 200Vpk.
- **LO Sense-LO Sense protection limitation:** 2Vpk.

3. Current input (I) terminal

I and LO terminals are used for current measurement. The maximum current which go through the **I** terminal is limited to 10A by the fuse on the back panel.

NOTE:

Voltage on the current input terminal corresponds to voltage on LO terminal. To keep good protection, only use the fuse of specified type and level to replace this fuse.

IEC Measurement Category II Over-voltage Protection

SDM3045X Digital Multimeter provides over-voltage protection for line-voltage mains connections meeting both of the following conditions to avoid the danger of electric shock:

- The HI and LO input terminals are connected to the mains under Measurement Category II conditions as following.
- The maximum line voltage of the mains is 300VAC.

WARNING:

IEC Measurement Category II includes electrical devices connected to mains at an outlet on a branch circuit, such as most small appliances, test equipments, and other devices that plug into a branch outlet or socket.

SDM3045X is capable of making measurements with the HI and LO inputs connected to mains in such devices (up to 300VAC) or the branch outlet itself. However, the HI and LO terminals of SDM3045X can't be connected to mains in permanently installed electrical devices such as the main circuit-breaker panels, sub-panel disconnected boxes and permanently wired motors. Such devices and circuits are prone to exceed the protection limits of SDM3045X.

NOTE:

Voltages above 300VAC only can be measured in circuits that are isolated from mains. However, there may be transient over-voltage in circuits that are isolated from mains. SDM3045X is able to withstand occasional transient over-voltage up to 2500Vpk. Please don't use this instrument to measure circuits that transient over-voltage may exceed this level.

Safety Terms and Symbols

Terms in this manual. Terms may appear in this manual.



WARNING: Warning statements indicate the conditions and behaviors that could result in injury or loss of life.



CAUTION: Caution statements indicate the conditions and behaviors that could result in damage to this product or other



CAT I (1000V): IEC Measurement Category I. The highest measurable voltage is 1000Vpk in the HI-LO terminal.



CAT II (300V): IEC Measurement Category II. Inputs may be connected to mains (up to 300VAC) under Category II overvoltage

Terms used on the instrument. Terms may appear on the instrument:

DANGER indicates an injury or hazard that may immediately happen.
WARNING indicates an injury or hazard that may not immediately happen.
CAUTION indicates that a potential damage to the instrument or other property might occur.

Symbols used on the instrument. Symbols may appear on the instrument.



**Hazardous
Voltage**



**Protective Earth
Ground**



Warning



**Test
Ground**



**Chassis
Ground**

Introduction of SDM3045X

SDM3045X is a 4½ dual-display instrument designed with 4½ digits readings resolution and dual-display, especially fitting to the needs of high-precision, multifunction, and automation measurements. It realized a combination of basic measurement functions, multiple math functions, and display functions, etc.

SDM3045X holds a 4.3 inch color TFT-LCD display screen. Its clear keyboard layout and operation hints make it easier and agility to use. Besides, it supports multi-interface such as USB Device, USB Host and LAN, which can meet users' demand furthest.

Main Features:

- 4.3 inch color TFT-LCD display screen with 480*272 high resolutions
- Real 4½ digits readings resolution
- Up to 150rdgs/S measurement speed
- True-RMS AC Voltage and AC Current measurements
- 1 Gb Nand Flash size, mass storage configuration files and data files
- Built-in cold terminal compensation for thermocouple
- Support standard SCPI and control software on PC, compatible with commands of main stream multimeters
- Supports dual-display function, Chinese and English menu
- Built-in help system, convenient to acquire information
- Support USB Device, USB Host and LAN interfaces
- Configuration and measured data can be imported or exported via VXI 11, USBTMC and USB flash drive, which is convenient for users to modify, view and backup

Abstract

The manual mainly introduces corresponding information of operating the SDM3045X Digital Multimeter. It contains these chapters:

Chapter 1 Quick Start

Guide you to prepare the SDM3045X Digital Multimeter and know about the Front/Back panel and user interface.

Chapter 2 Function and Operation

Introduce the functions and operations of SDM3045X in details.

Chapter 3 Application Examples

Introduce you how to use strong measurement functions of this instrument easily through some examples.

Chapter 4 Measurement Tutorial

Guide you to eliminate the errors that may appear during your measurement and obtain accurate result.

Chapter 5 General Troubleshooting

Provide you some general troubleshooting.

Chapter 6 Appendix

Provide you information about accessories, warranties, troubleshooting, services and supports.

Content

Copyright and Statement	I
General Safety Summary	II
Safety Terms and Symbols	V
Introduction of SDM3045X	VI
Abstract	VII
Content	VIII
Chapter 1 Quick Start	1
General Inspection.....	2
To adjust the Handle.....	3
Front Panel	4
Back Panel.....	5
Power On.....	6
User Interface	7
Chapter 2 Function and Operation	8
To Select Measurement Range	9
To Select Measurement Speed	11
Basic Measurement Functions.....	12
To Measure DC Voltage	13
To Measure DC Current	15
To Measure AC Voltage	17
To Measure AC Current.....	19
To Measure 2-Wire/4-Wire Resistance.....	21
To Measure Capacitance.....	25
To Measure Frequency or Period	27
To Test Continuity.....	31
To Test Diode	33
To Measure Temperature	35
Measurement Parameters	39
DC Input Impedance.....	39
DC input impedance selection:	39
Short-circuit Resistance.....	40
Short-circuit Resistance:	40
Dual-display Function	41
Utility Function	43
Store and Recall	44
Manage File.....	46
I/O Configuration	48
Board Test.....	50
System Setup	53
Firmware Update	55
Acquire.....	56
Auto Trigger	57

Sample Count	57
Single Trigger	58
External Trigger	59
Help System	60
Math Function	62
Statistics	64
Limits	66
The range of Limits function:	67
dBm	68
dB	69
Relative Value	70
Display Mode	71
Trigger	77
Hold Measurement Function.....	78
Chapter 3 Application Examples	79
Example 1: Reading Statistic Functions	80
Example 2: To Eliminate Leads Impedance.....	81
Example 3: dBm Measurement.....	83
Example 4: dB Measurement.....	84
Example 5: Limits Test	86
Example 6: To Use Hold Measurement Function	88
Chapter 4 Measurement Tutorial	90
True RMS AC Measurement.....	90
Crest Factor Errors (non-sinusoidal inputs)	91
Loading Errors (AC Voltage).....	92
Chapter 5 General Troubleshooting	93
Chapter 6 Appendix	94
Appendix A: Accessories	94
Appendix B: Warranty summary	95
Appendix C: Daily Maintenance and Cleaning.....	96
Appendix D: Contact SIGLENT.....	97



Chapter 1 Quick Start

- **General Inspection**
- **Handle Adjustment**
- **The Front Panel**
- **The Back Panel**
- **To Connect Power Line**
- **User Interface**
- **To Use Safety Lock**

General Inspection

1. Inspect the shipping container.

Please keep the damaged container or cushioning material until the contents of the shipment have been checked completely and the instrument has passed the electrical and mechanical test.

Damages of the instrument caused by the shipment will be compensated by the shipper or carrier. SIGLENT will not be responsible for the free repair or replacement.

2. Inspect the instrument.

If there exit any mechanical damages or lacking of components, or the instrument fails the electrical and mechanical test, please contact your SIGLENT sales.

3. Check the accessories.

Check the accessories according to the packing list carefully. If there exit any accessories damaged or missing, please contact your SIGLENT sales.

To adjust the Handle

Adjust the handle position of SDM3045X properly to place the instrument stably so that users can manipulate and observe the display better. Please grip the handle by the two sides and pull it outward. Then rotate the handle to the appropriate position. Please operate as the following diagram.

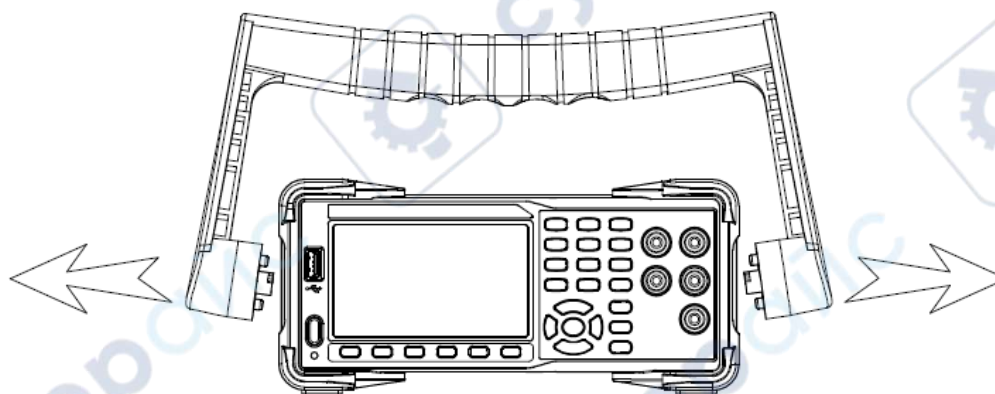

Diagram 1-1 Handle adjustment

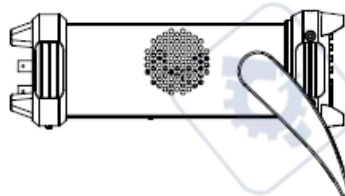
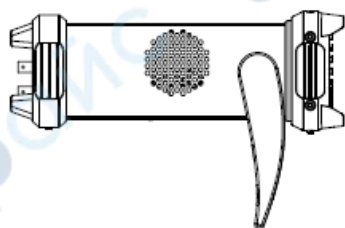

Diagram 1-2 Horizontal Position

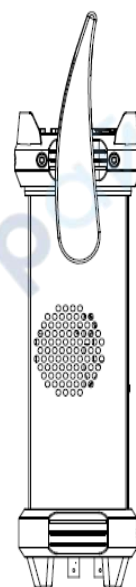

Diagram 1-3 Carrying Position

Front Panel

SDM3045X Digital Multimeter provides users with brief and clear front panel. These control buttons are group by logic and users only need choose corresponding buttons to carry out basic operations, as shown in Diagram 1-4.



Diagram 1- 4 Front Panel Overview

- A** LCD Display
- B** USB Host
- C** Power Key
- D** Menu Operation Keys
- E** Measurement and Assistant Function Keys
- F** Range and Direction Keys
- G** Signal input terminals

Back Panel

SDM3045X Digital Multimeter's Back Panel provides users with abundant interfaces as shown in the following diagram.

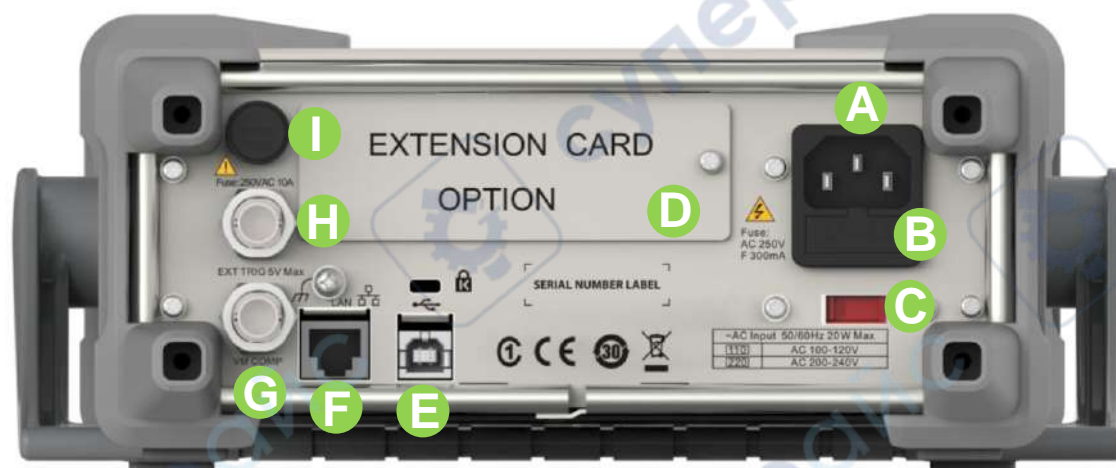

Diagram 1- 5 Back Panel Overview

- A** Power Socket
- B** Power Fuse
- C** AC Voltage Selector
- D** Inspection card (option)
- E** USB Device
- F** LAN
- G** VMC Output
- H** Ext trigger
- I** Current Input Fuse

Power On

Please power on the instrument as the following steps:

1. Adjust AC Voltage Selector to 110 (100~120V, 45~440Hz, AC) or 220 (200~240V, 50/60Hz, AC) in accordance with power standards in your country;
2. Connect the instrument to AC supply via power cord supplied by **SIGLENT**;
3. The power indicator light on the front panel will glitter slowly;
4. Press the power key on the front panel, the instrument will be started a few seconds later.

User Interface

Single Display:

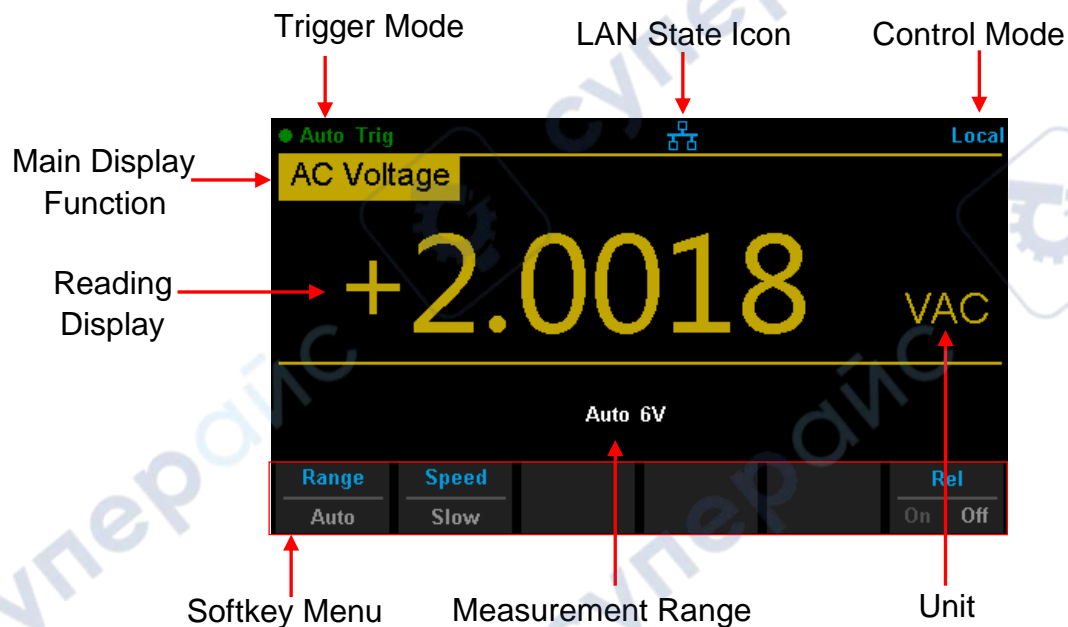

Diagram 1-6 Single Display Interface

Dual-Display:

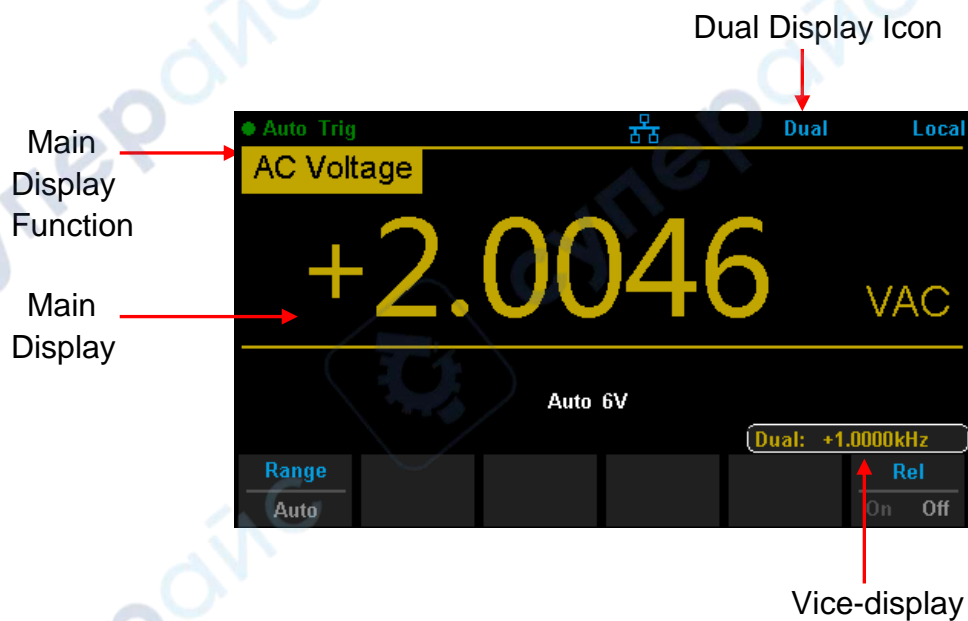
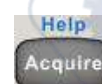
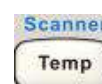

Diagram 1-7 User Interface

Chapter 2 Function and Operation

- To Measure DC Voltage / Current
- To Measure AC Voltage / Current
- To Measure 2-Wire / 4-Wire Resistance
- To Measure Frequency / Capacitance
- To Test Continuity / Diode
- To Measure Temperature / Optional Multiple Scan Card
- To use Dual-display Function or Set Up the Utility
- Acquire Function or Help System
- Math Function or Display Function
- Run / Stop
- Single Trigger / Hold Measurement Function
- To Switch Functions or Return to Local Menu
- To Select Measurement Range



To Select Measurement Range

The Multimeter has two kinds of modes of selecting measurement range: “Auto” and “Manual”. It can select appropriate range according to the signals input in Auto mode, which is very convenient for users. While in Manual mode, you can obtain higher reading precision. Range selection keys are on the right side of the front panel as the following diagram.

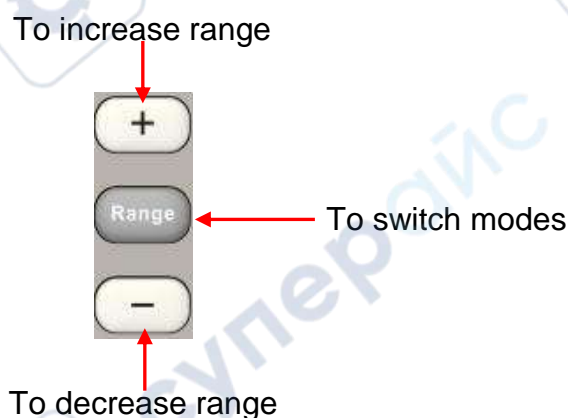



Diagram 2- 1 Range Selection Keys

Method 1: By Function keys on the Front Panel

Auto Range: Press  to switch between Auto Range and Manual Range.

Manual Range: Press  to increase range and press  to decrease range.

Method 2: By softkeys on the measurement main interface as Diagram 2-2.

Auto Range: Press **【Auto】** to choose Auto Range, meanwhile Manual Range is forbidden.

Manual Range: Press **【600mV】**、**【6V】**、**【60V】**、**【600V】** or **【1000V】** to choose required range manually. Auto Range is forbidden at this moment.

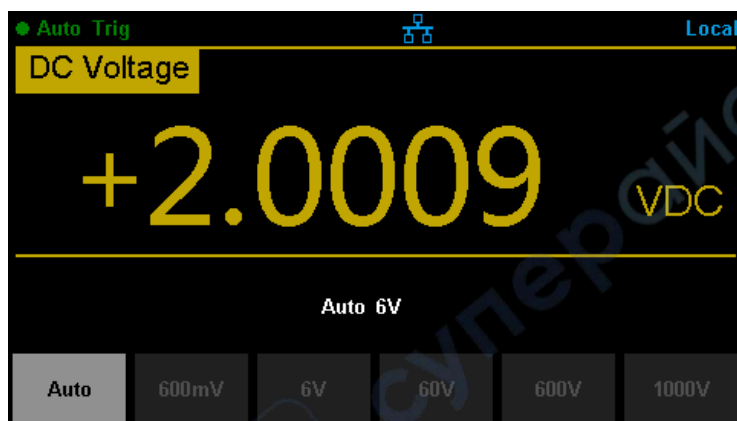

Diagram 2- 2 Range selection menus

Explanations:

1. When the input signal is beyond the current scope of the measurement range, the Multimeter will show “overload”.
2. Range option will turn back to default setting “Auto” after restarting and remote reset.
3. Users are suggested to select “Auto” range so as to protect the instrument against damage and get exact data as much as possible when it’s hard to predict the range of measurement.
4. For Dual-display Function, the measurement range of vice display is auto.
5. The range is fixed during testing the Continuity. The range of continuity is selected as 2k Ω .

To Select Measurement Speed

The instrument provides three types of measurement rate: 5 reading/s, 50 reading/s and 150 reading/s. 5 reading/s belongs to “Slow” rate; 50 reading/s belongs to “Middle” rate; 150 reading/s belongs to “Fast” rate.

Measurement speed can be controlled by softkey menu. Press **【Speed】** and then press **【Slow】** , **【Middle】** or **【Fast】** to choose measurement speed.

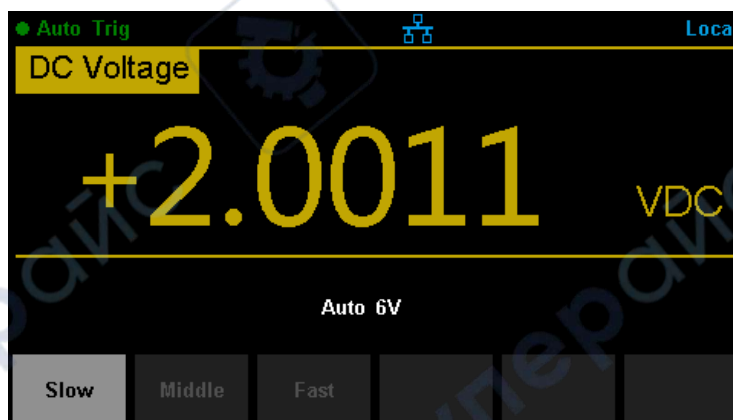

Diagram 2- 3 Range selection menu

Explanations:

1. Three reading rates are available for DCV, ACV, DCI, ACI and 2-Wire/4-Wire Resistance: “Slow”, “Middle” and “Fast”.
2. There is a linkage for both reading resolution and reading (measurement) rate.
3. 5 reading/s and 50 reading/s belongs to 4.5 digit resolution.
4. 150 reading/s belong to 3.5 digit resolution.
5. The reading resolution of Temperature is fixed at 4.5 digit and “Fast” respectively.
6. The reading resolutions and measurement rates of both Diode and Continuity are fixed at 4.5 digit and “Fast” respectively.
7. The reading resolution and measurement rate of the Frequency function are fixed 4.5 digit and “Slow” respectively.
8. The reading resolution and measurement rate of the Capacitance function are fixed at 3.5 digit and “Slow” respectively.

Basic Measurement Functions

SDM3045X Digital Multimeters have following basic functions:

- To Measure DC Voltage
- To Measure AC Voltage
- To Measure DC Current
- To Measure AC Current
- To Measure 2/4-Wire Resistance
- To Measure Capacitance
- To Test Continuity
- To Test Diode
- To Measure Frequency or Period
- To Measure Temperature

To Measure DC Voltage

The Multimeter enables to measure DC Voltage up to 1000V. The method to connect and measure DC Voltage will be introduced in details as the following steps.

Operating Steps:

1. Press  on the front panel to enter the DC Voltage measurement interface, as shown in Diagram 2- 4.

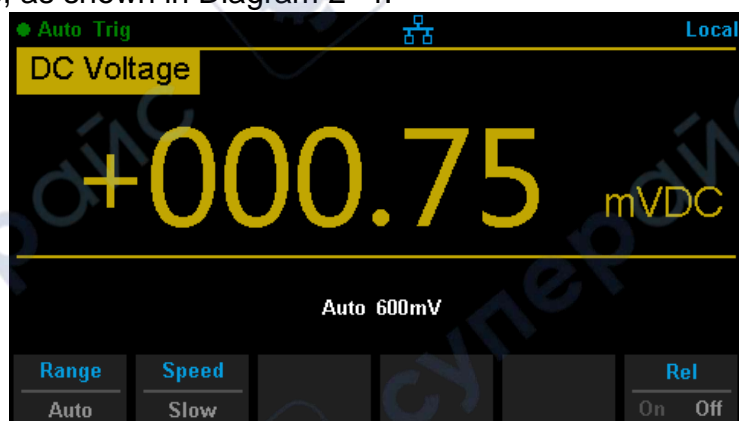

Diagram 2- 4 DC Voltage Measurement Interface

2. Connect the red lead to terminal Input-HI and black lead to terminal Input-LO as the following diagram.

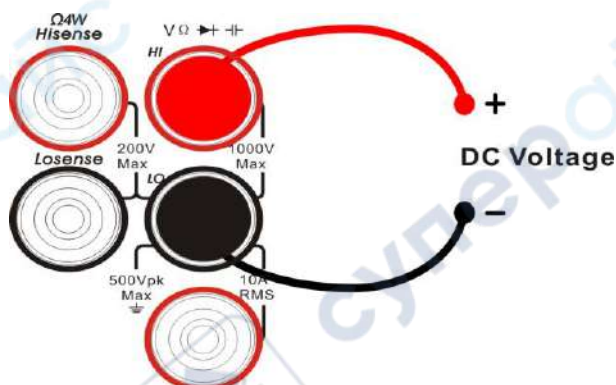

Diagram 2- 5 Sketch Map for Measuring DC Voltage

3. Choose a proper voltage range according to the measured circuit.

Table 2- 1 Measurement Characteristics of DC Voltage

Ranges*	600mV、6V、60V、600V、1000V
Input Protection	1000V on all ranges (HI terminal)
Configurable	Range, Speed, DC input impedance, Rel

NOTE*:

- All the ranges enable to obtain 10% value higher than original except 1000V. Besides, both Manual and Auto are available for setting every range.
- When inputting range is higher than 1000V at 1000V Level, “overload” will be shown on the screen.
- 1000V input protection exists in every range.

4. Set the DC input impedance (Only for Manual 600mV range).

Press **【Input Z】** to set the DC resistance as “10M” (default value) or “>10G”. Users can execute DC voltage measurement directly without modifying this parameter which has been setup before leaving factory.

5. Set relative value (Optional operation).

Press **【Rel】** to open or close Relative math function. When it is opened, the reading displayed is a value which comes from the result of actual measurement value subtracts the relative value that has been set. The default relative value is the measurement value when the function is opened.(Please refer to “ Math Functions” in Chapter 2 to know about the details.)

6. Read measurement result.

Select required measurement rate (reading rate) by pressing **【Speed】** and read the measurement result.



7. View history data.

There are four types of way to view historical data: “Number”, “Bar Meter” ”Trend Chart” and “Histogram”.

To Measure DC Current

The Multimeter enables to measure DC Current up to 10A. The method to connect and measure DC Current will be introduced in details as the following steps.

Operating Steps:

1. Press  and  on the front panel to enter the DC Current measurement interface, as shown in Diagram 2- 6.

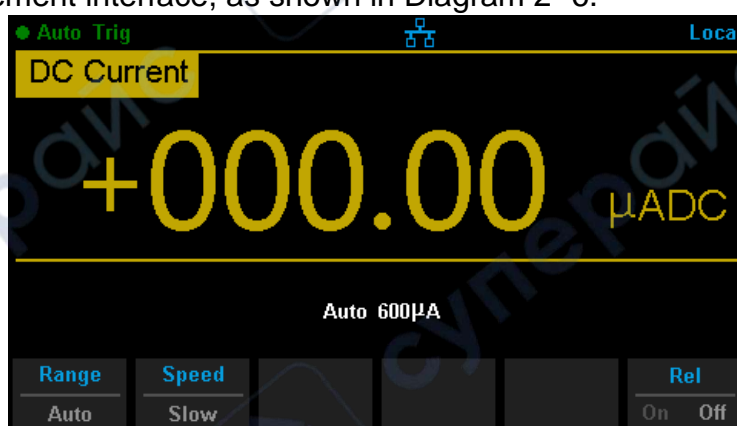

Diagram 2- 6 DC Voltage Measurement Interface

2. Connect the red lead to terminal Input-I and black lead to terminal Input-LO as the following diagram.

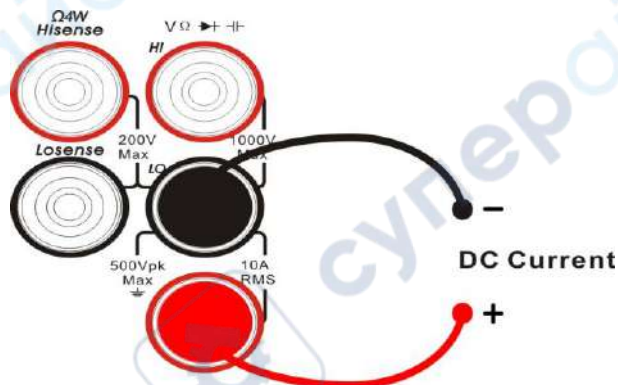

Diagram 2- 7 Sketch Map for Measuring DC Current

- Choose a proper current range according to the measured circuit.

Table 2- 2 Measurement Characteristics of DC Current

Ranges*	600 μ A、6mA、60mA、600mA、6A、10A
Input Protection	10A(back panel), 12A(inside the instrument)
Configurable	Range, Speed, Rel

NOTE*:

All the ranges enable to obtain 10% value higher than original except 10A. Besides, both Manual and Auto are available for setting every range.

- Set relative value (Optional operation).

Press **【Rel】** to open or close Relative math function. When it is opened, the reading displayed is a value which comes from the result of actual measurement value subtracts the relative value that has been set. The default relative value is the measurement value when the function is opened. (Please refer to “ Math Functions” in Chapter 2 to know about the details.)

- Read measurement result.

Select required measurement rate (reading rate) by pressing **【Speed】** and read the measurement result.

- View history data.

There are four types of way to view historical data: “Number”, “Bar Meter” ”Trend Chart” and “Histogram”.

To Measure AC Voltage

The Multimeter enables to measure AC Voltage up to 750V. The method to connect and measure DC Voltage will be introduced in details as the following steps.

Operating Steps:

1. Press  on the front panel to enter the AC Voltage measurement interface, as shown in Diagram 2- 8.

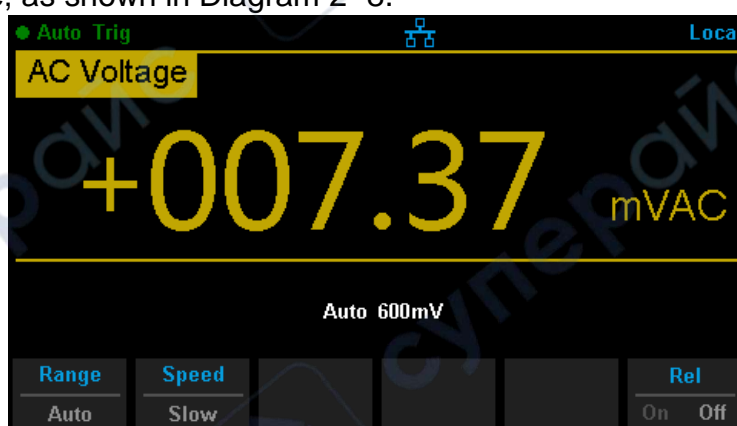

Diagram 2- 8 AC Voltage Measurement Interface

2. Connect the red lead to terminal Input-HI and black lead to terminal Input-LO as the following diagram.

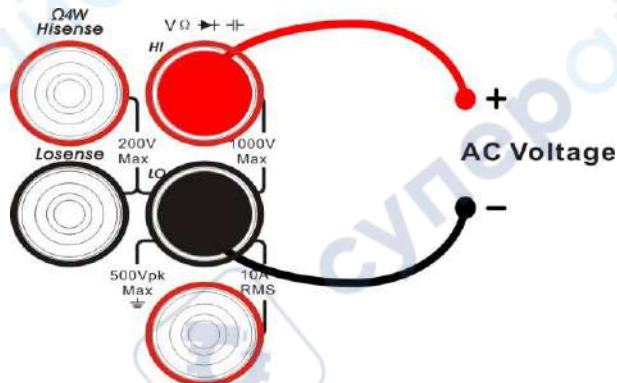

Diagram 2- 9 Sketch Map for Measuring AC Voltage

3. Choose a proper voltage range according to the measured circuit.

Table 2- 3 Measurement Characteristics of AC Voltage

Ranges*	600mV、6V、60V、600V、750V
Input Protection	750Vrms on all ranges (HI terminal)
Configurable	Range, Speed, Rel

NOTE*:

- All the ranges enable to obtain 10% value higher than original except 750V. Besides, both Manual and Auto are available for setting every range.
- When inputting range is higher than 750V at 750V Level, “overload” will be shown on the screen.
- 750V input protection exists in every range.

4. Set relative value (Optional operation).

Press **【Rel】** to open or close Relative math function. When it is opened, the reading displayed is a value which comes from the result of actual measurement value subtracts the relative value that has been set. The default relative value is the measurement value when the function is opened. (Please refer to “Math Functions” in Chapter 2 to know about the details.)

5. Read measurement result.

Select required measurement rate (reading rate) by pressing **【Speed】** and read the measurement result. If you press **Dual** and then press **Shift** and **+/-** to get the frequency value measured from input AC signal.

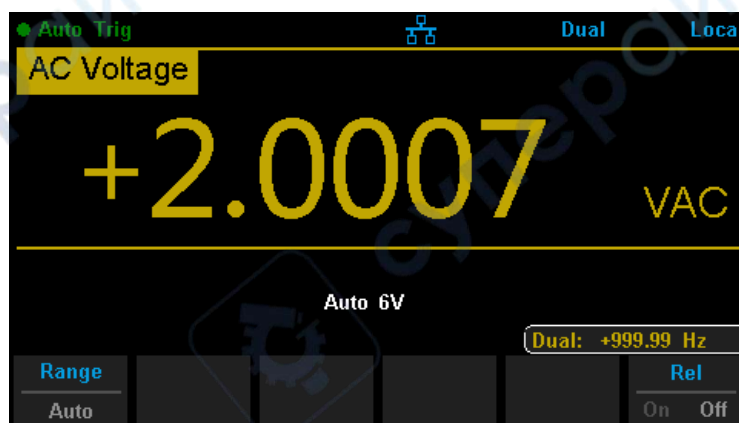

Diagram 2- 10 Dual-display



6. View history data.

There are four types of way to view historical data: “Number”, “Bar Meter” “Trend Chart” and “Histogram”.

To Measure AC Current

The Multimeter enables to measure AC Current up to 10A. The method to connect and measure AC Current will be introduced in details as the following steps.

Operating Steps:

1. Press  and  on the front panel to enter the AC Current measurement interface, as shown in Diagram 2- 11.

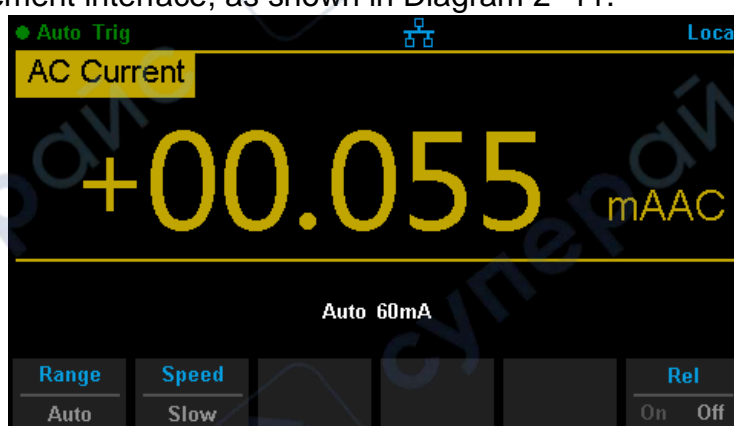

Diagram 2- 11 AC Voltage Measurement Interface

2. Connect the red lead to terminal Input-I and black lead to terminal Input-LO as the following diagram.

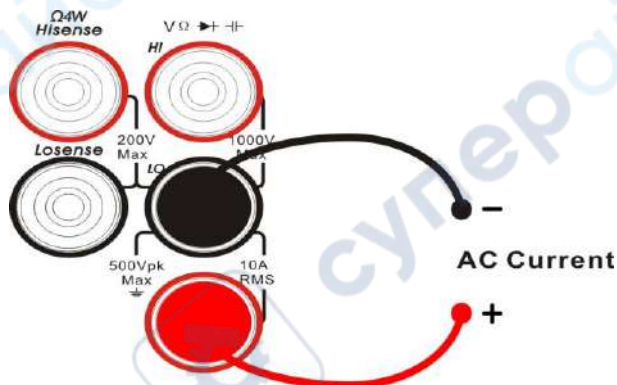

Diagram 2- 12 Sketch Map for Measuring AC Current

3. Choose a proper current range according to the measured circuit.

Table 2- 4 Measurement Characteristics of AC Current

Ranges*	60mA、600mA、6A、10A
Input Protection	10A(back panel), 250V(fuse), 12A(inside the instrument)
Configurable	Range, Speed, Rel

NOTE*:

All the ranges enable to obtain 10% value higher than original except 10A. Besides, both Manual and Auto are available for setting every range.

4. Set relative value (Optional operation).

Press **【Rel】** to open or close Relative math function. When it is opened, the reading displayed is a value which comes from the result of actual measurement value subtracts the relative value that has been set. The default relative value is the measurement value when the function is opened. (Please refer to “Math Functions” in Chapter 2 to know about the details.)

5. Read measurement result.

Select required measurement rate (reading rate) by pressing **【Speed】** and read the measurement result.

6. View history data.

There are four types of way to view historical data: “Number”, “Bar Meter” “Trend Chart” and “Histogram”.

To Measure 2-Wire/4-Wire Resistance

The Multimeter enables to measure 2-Wire Resistance and 4-Wire Resistance. The method to connect and measure 2-Wire/4-Wire Resistance will be introduced in details separately.

2-Wire Resistance

Operating Steps:

1. Press  on the front panel to enter the 2-Wire Resistance measurement interface, as shown in Diagram 2- 13.

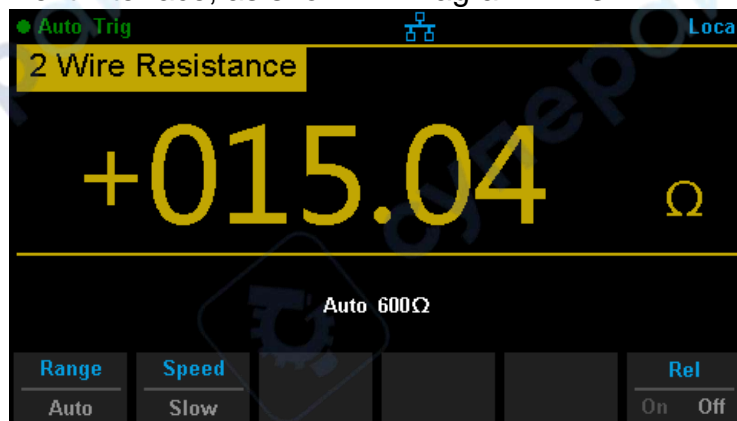

Diagram 2- 13 2-Wire Resistance Measurement Interface

2. Connect the red lead to terminal Input-HI and black lead to terminal Input-LO as the following diagram.

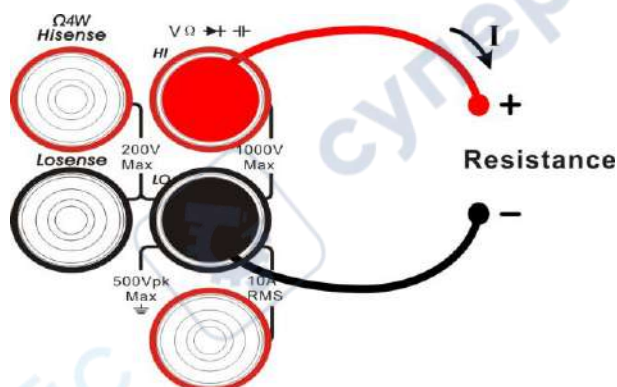

Diagram 2- 14 Sketch Map for Measuring 2-Wire Resistance

3. Choose a proper resistance range according to the scope.

Table 2- 5 Measurement Characteristics of 2-Wire Resistance

Ranges*	600Ω、6kΩ、60kΩ、600kΩ、6MΩ、10MΩ、100MΩ
Open-circuit Voltage	<8V
Input Protection	1000V on every range (HI terminal)
Configurable	Range, Speed, Rel

NOTE*:

All the ranges enable to obtain 10% value higher than original. Besides, both Manual and Auto are available for setting every range.

4. Set relative value (Optional operation).

Press **【Rel】** to open or close Relative math function. When it is opened, the reading displayed is a value which comes from the result of actual measurement value subtracts the relative value that has been set. The default relative value is the measurement value when the function is opened. (Please refer to “Math Functions” in Chapter 2 to know about the details.)

5. Read measurement result.

Select required measurement rate (reading rate) by pressing **【Speed】** and read the measurement result.

6. View history data.

There are four types of way to view historical data: “Number”, “Bar Meter” ”Trend Chart” and “Histogram”.

NOTE:

You are suggested to make use of Relative function when measuring small resistance to reduce or escape impedance error from Test leads.

4-Wire Resistance

Operating Steps:



1. Press  and  on the front panel to enter the 4-Wire Resistance measurement interface, as shown in Diagram 2- 14.



Diagram 2- 15 4-Wire Resistance Measurement Interface

2. Connect the red lead to terminal Input-HI and black lead to terminal Input-LO as the following diagram.

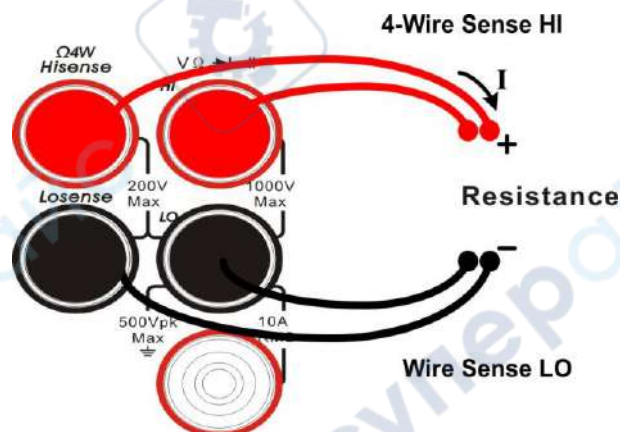

Diagram 2- 16 Sketch Map for Measuring 4-Wire Resistance

- Choose a proper resistance range according to the scope.

Table 2- 6 Measurement Characteristics of 4-Wire Resistance

Ranges*	200Ω、2kΩ、20kΩ、200kΩ、2MΩ、10MΩ、100MΩ
Open-circuit Voltage	<8V
Input Protection	(1) 1000V on each range (HI terminal) (2) 200V on each range (HI Sense, LO Sense)
Configurable Parameters	Range, Speed, Rel

NOTE*:

All the ranges enable to obtain 20% value higher than original. Besides, both Manual and Auto are available for setting every range.

- Set relative value (Optional operation).

Press **【Rel】** to open or close Relative math function. When it is opened, the reading displayed is a value which comes from the result of actual measurement value subtracts the relative value that has been set. The default relative value is the measurement value when the function is opened. (Please refer to “Math Functions” in Chapter 2 to know about the details.)

- Read measurement result.

Select required measurement rate (reading rate) by pressing **【Speed】** and read the measurement result.

- View history data.

There are four types of way to view historical data: “Number”, “Bar Meter” “Trend Chart” and “Histogram”.

NOTE:

Please do not put the terminals of the resistance on the conductive plane or in your hand to avoid error. The bigger of the resistance, the more affection it will be brought.

To Measure Capacitance

The Multimeter enables to measure Capacitance up to 1000 μ F. The method to connect and measure Capacitance will be introduced in details as the following steps.

Operating Steps:

1. Press  on the front panel to enter the Capacitance measurement interface, as shown in Diagram 2- 16.

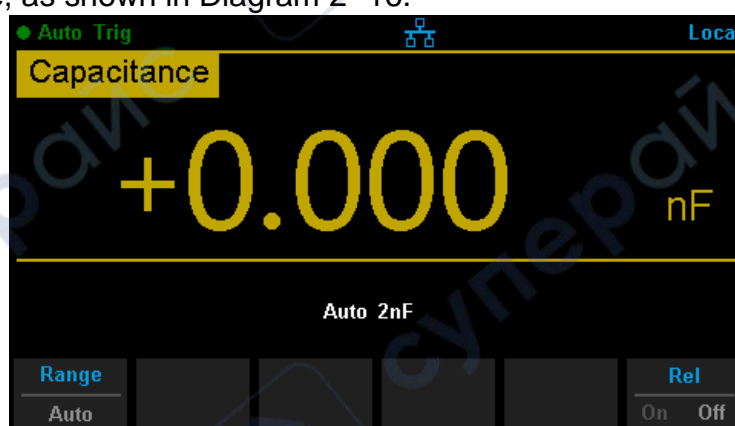

Diagram 2- 17 Capacitance Measurement Interface

2. Connect the red lead to terminal Input-HI and black lead to terminal Input-LO as the following diagram.

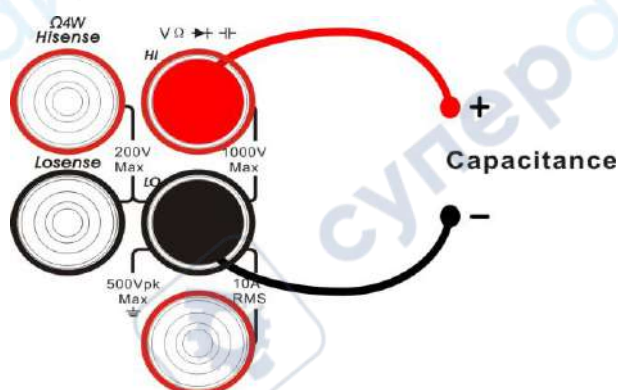

Diagram 2- 18 Sketch Map for Measuring Capacitance

- Choose a proper capacitance range according to the measured circuit.

Table 2- 7 Measurement Characteristics of Capacitance

Ranges*	2nF、20nF、200nF、2 μ F、200 μ F、200 μ F、10000 μ F
Input Protection	1000V on all ranges (HI terminal)
Configurable Parameters	Range, Rel

NOTE*:

All the ranges enable to obtain 20% value higher than original. Besides, both Manual and Auto are available for setting every range.

- Set relative value (Optional operation).

Press **【Rel】** to open or close Relative math function. When it is opened, the reading displayed is a value which comes from the result of actual measurement value subtracts the relative value that has been set. The default relative value is the measurement value when the function is opened. (Please refer to “Math Functions” in Chapter 2 to know about the details.)

- Read measurement result.

Capacitance measurement is fixed at “Slow” rate. Therefore, you can't adjust the reading rate when reading the result.

- View history data.

There are four types of way to view historical data: “Number”, “Bar Meter” “Trend Chart” and “Histogram”.

NOTE:



Before measuring the electrolytic capacitance, you should make the two legs of the electrolytic capacitance short circuit and let it be discharged.

To Measure Frequency or Period

The Frequency or Period of a signal could be obtained by Dual-display Function during measuring its voltage or current or by the function button on the front panel. The method to connect and measure Frequency or Period will be introduced in details as the following steps.

To Measure Frequency

Operating Steps:

1. Press  and  on the front panel to enter the Frequency measurement interface. The lower right corner of the screen shows the unit of Frequency, as shown in Diagram 2- 17.

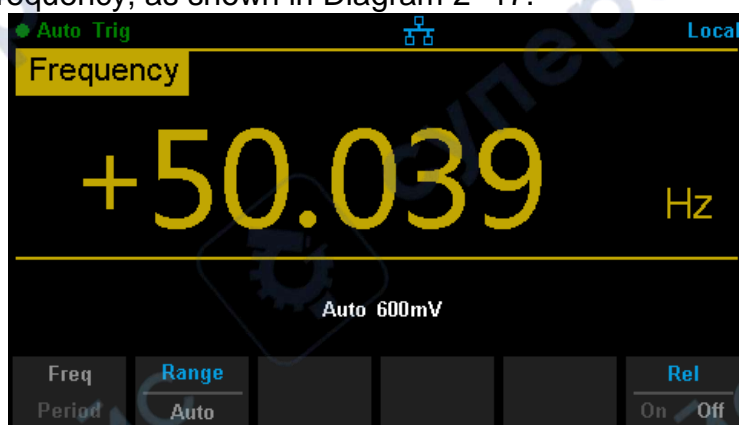

Diagram 2- 19 Frequency Measurement Interface

2. Connect the red lead to terminal Input-HI and black lead to terminal Input-LO as the following diagram.

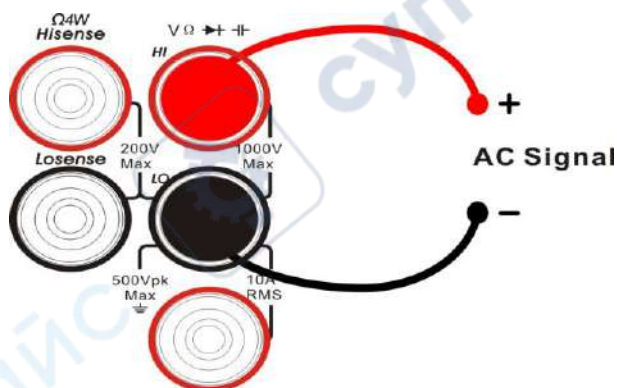

Diagram 2- 20 Sketch Map for Measuring Frequency

3. Choose a proper voltage range according to the measured circuit.

Table 2- 8 Measurement Characteristics of Frequency

Ranges	600mV,6V,60V, 600V, 750V
Measurement Range	20Hz ~ 500kHz
Input Protection	750Vrms on all ranges (HI terminal)
Configurable	Range, Rel

4. Set relative value (Optional operation).

Press **【Rel】** to open or close Relative math function. When it is opened, the reading displayed is a value which comes from the result of actual measurement value subtracts the relative value that has been set. The default relative value is the measurement value when the function is opened. (Please refer to “ Math Functions” in Chapter 2 to know about the details.)

5. Read measurement result.

Frequency measurement is fixed at “Slow” rate. Therefore, you can’t adjust the reading rate while reading the result.

6. View history data.

There are four types of way to view historical data: “Number”, “Bar Meter” ”Trend Chart” and “Histogram”.

To Measure Period

Operating Steps:



1. Press  and  on the front panel and select **【Period】** to enter the Period measurement interface. The lower right corner of the screen shows the unit of Period, as shown in Diagram 2- 21.



Diagram 2- 21 Period Measurement Interface

2. Connect the red lead to terminal Input-HI and black lead to terminal Input-LO as the following diagram.

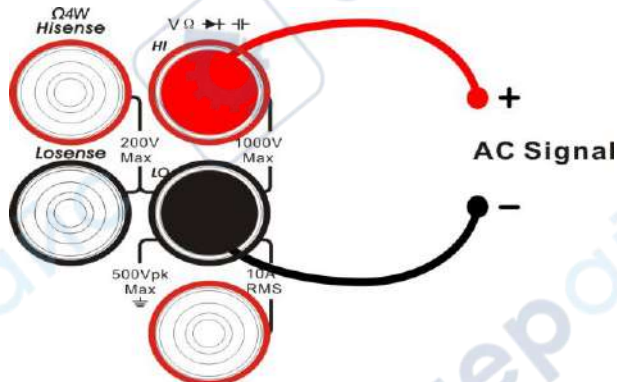

Diagram 2- 22 Sketch Map for Measuring Period

3. Choose a proper voltage range according to the measured circuit.

Table 2- 9 Measurement Characteristics of Period

Ranges	200mV, 2V, 20V, 200V, 750V
Measurement Range	2 μ s – 50ms
Input Protection	750Vrms on all ranges (HI terminal)
Configurable	Range, Rel

4. Set relative value (Optional operation).

Press **【Rel】** to open or close Relative math function. When it is opened, the reading displayed is a value which comes from the result of actual measurement value subtracts the relative value that has been set. The default relative value is the measurement value when the function is opened. (Please refer to “Math Functions” in Chapter 2 to know about the details.)

5. Read measurement result.

Period measurement is fixed at “Slow” rate. Therefore, you can't adjust the reading rate while reading the result.

6. View history data.

There are four types of way to view historical data: “Number”, “Bar Meter” “Trend Chart” and “Histogram”.

To Test Continuity

Continuity test uses double leads method to measure the resistance of the measured circuit via about 0.5mA current. When the measured resistance in circuit is lower than the selected one, it is considered being connected with instrument. The method to test Continuity will be introduced in details as the following steps.

Operating Steps:

1. Press  on the front panel to enter the Continuity test interface, as shown in Diagram 2- 23.

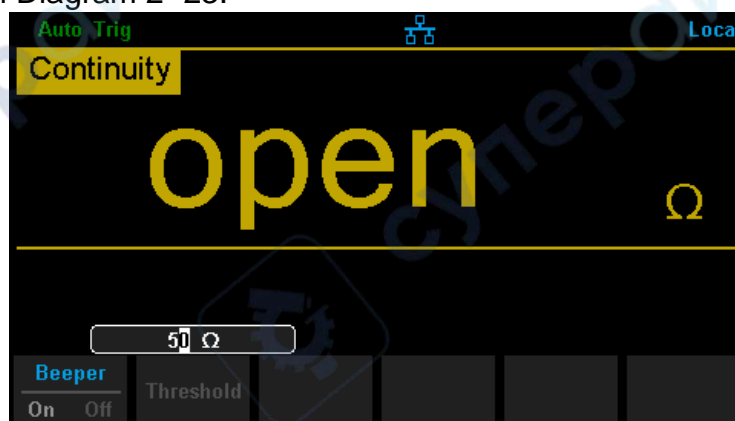

Diagram 2- 23 Continuity Measurement Interface

2. Connect the red lead to terminal Input-HI and black lead to terminal Input-LO as the following diagram.

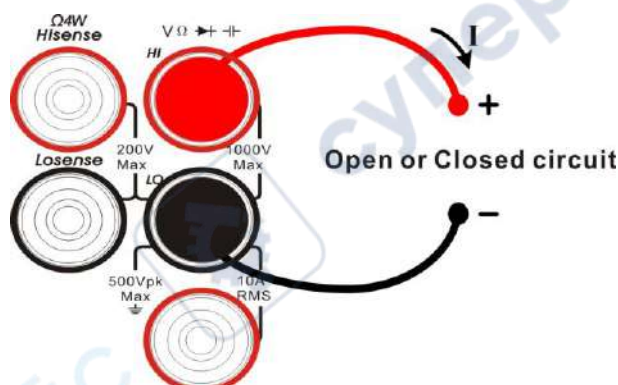

Diagram 2- 24 Sketch Map for Testing Continuity

3. Set the Short-circuit resistance.

The default value is set as 50Ω before leaving factory. The value can be changed by using direction keys. You also can execute the Continuity measurement directly without modification.

Table 2- 10 Measurement Characteristics of Continuity

Test Current	1mA
Ranges*	Fixed at 2kΩ
Open-circuit Voltage	<8V
Input Protection	1000V on all ranges (HI terminal)
Beeper Condition	$0 \leq R_{\text{testing}} \leq \text{Short-circuit impedance}$ $0\Omega \leq \text{Short-circuit impedance} \leq 2\text{k}\Omega$

4. Set the Beeper function.

Press **【Beeper】** to turn on or off the Beeper. If the circuit is continuous, the instrument will beep continually when the Beeper is turned on.

5. Search for the test point and read measurement result.



NOTE:

Before testing continuity, please cut off the power and discharge all the high-voltage containers to avoid damages to the Multimeter.

To Test Diode

If input voltage is under Threshold the Beeper will beep persistently. The method to test Diode will be introduced in details as the following steps.

Operating Steps:

1. Press  and  on the front panel to enter the Diode test interface, as shown in Diagram 2- 25.

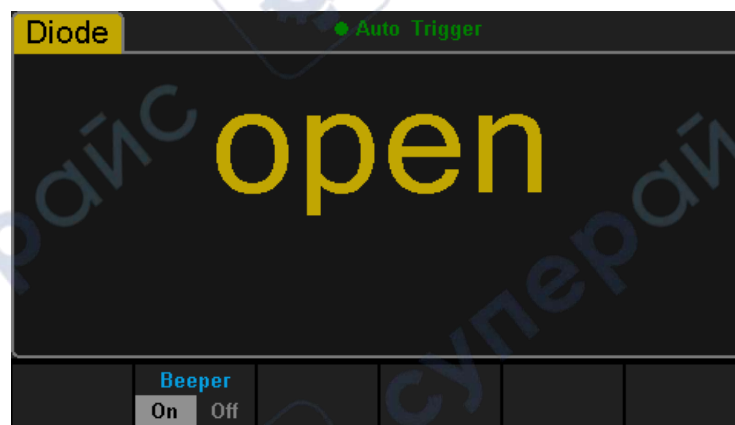

Diagram 2- 25 Diode Test Interface

2. Connect red lead to both terminal Input-HI and anode of the Diode and black lead to both terminal Input-LO and cathode of the Diode as the following diagram.

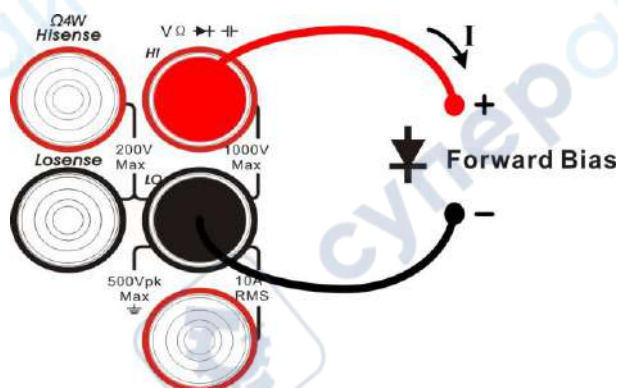

Diagram 2- 26 Sketch Map for testing Diode

3. Set the Threshold.

The default value is set as 2V before leaving factory. The value can be changed by using direction keys. You also can execute the Diode measurement directly without modification.

Table 2- 11 Characteristics of Checking Diodes

Test Current	1mA
Ranges*	0~4V
Open-circuit Voltage	<8V
Input Protection	1000V (HI terminal)
Beep Condition	$V_{\text{measured}} \leq \text{Threshold}$

4. Set the Beeper function.
Press **【Beeper】** to turn on or off the Beeper. If the circuit is continuous, the instrument will beep persistently when the Beeper is turned on.
5. Read measurement result.
6. Reverse the probes and measure the voltage in the diode once more.
Evaluate the diode according to the following rules:
 - If the Multimeter shows “overload” when in reverse bias model, it indicates that the diode is normal.
 - If the Multimeter shows voltage about 0V and the instrument beeps persistently when in forward and reverse bias model, it indicates that the diode is short.
 - If the Multimeter shows “overload” when in forward and reverse model, it indicates that the diode is open.

Note:

Before testing diode, please cut off the power and discharge all the high-voltage containers to avoid damages to the Multimeter.

To Measure Temperature

The Multimeter supports for two types of temperature sensor: TC and RTD. The method to connect and measure Temperature will be introduced in details as the following steps.

Operating Steps:

1. Press  on the front panel to enter the Temperature measurement interface, as shown in Diagram 2- 27.

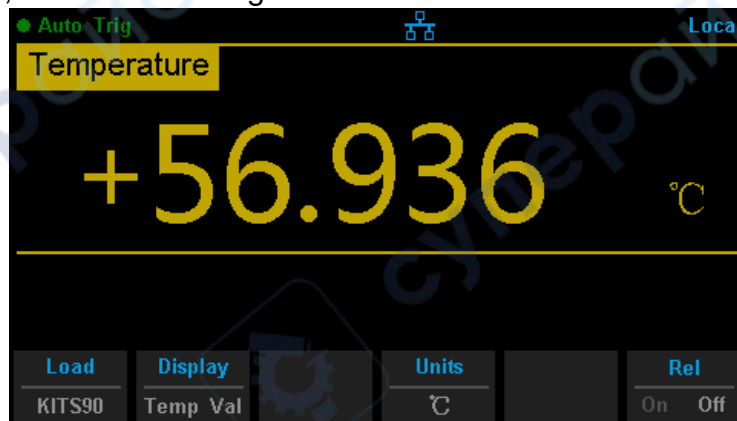

Diagram 2- 27 Temperature Measurement Interface

2. Connect the red lead to terminal Input-HI and black lead to terminal Input-LO as the following diagram.

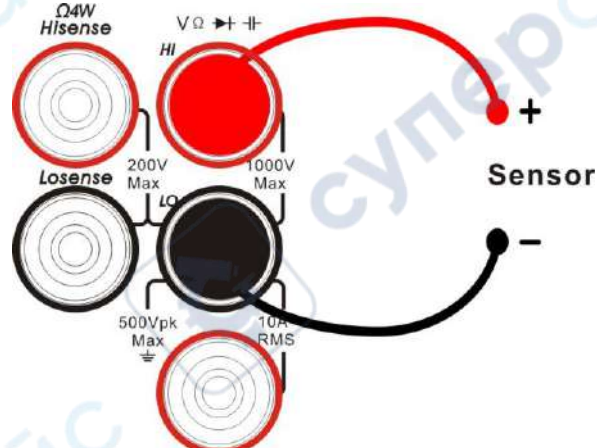

Diagram 2- 28 Sketch Map for Measuring Temperature

3. Press **【Load】** and use direction keys to select the required file. Then press **【Read】** to recall an existing configuration file.

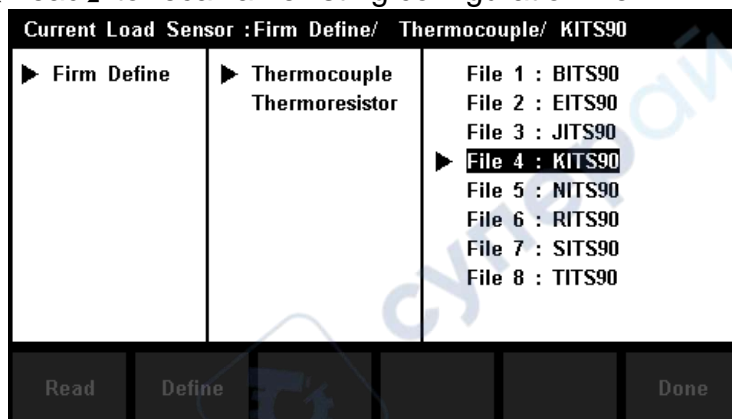

Diagram 2- 29 Load a Configuration File

4. Press **【Define】** to view the configuration, as shown in the following diagram:

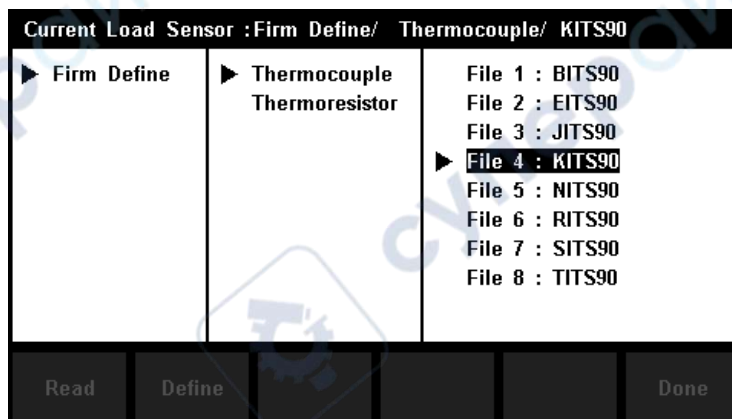

Diagram 2- 30 Configuration of the Sensor

5. Press **【Display】** to choose a display mode. The Multimeter supports three display modes: Temperature Value, Measured Value and All.

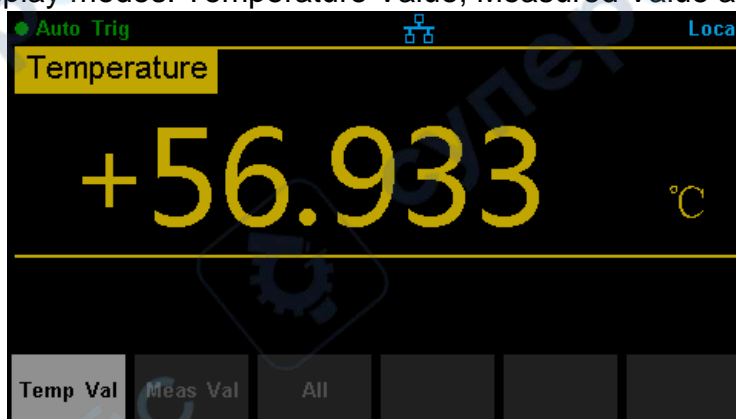

Diagram 2- 31 Choose Display Mode of Temperature Measurement

Press **【All】**, the measured value will be shown on the Vice display and the corresponding value will be shown on the Main display at the same time, which is convenient for users to observe temperature and voltage values (or resistance value).

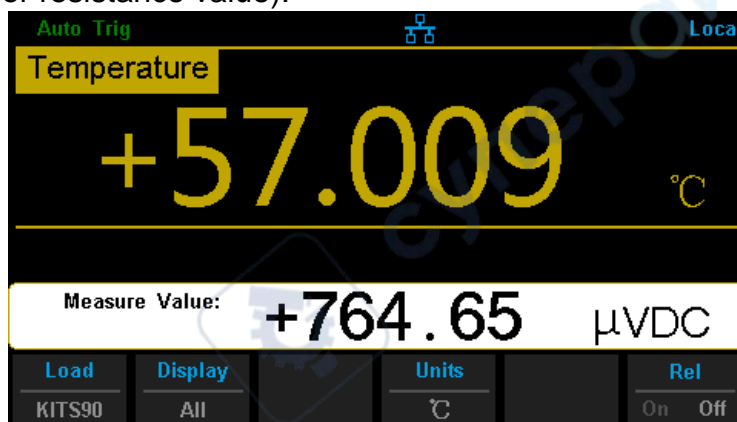

Diagram 2- 32 Show Temperature And Voltage Values

- Press **【Units】** to choose the unit of temperature. The Multimeter supports three units: °C, °F, K.

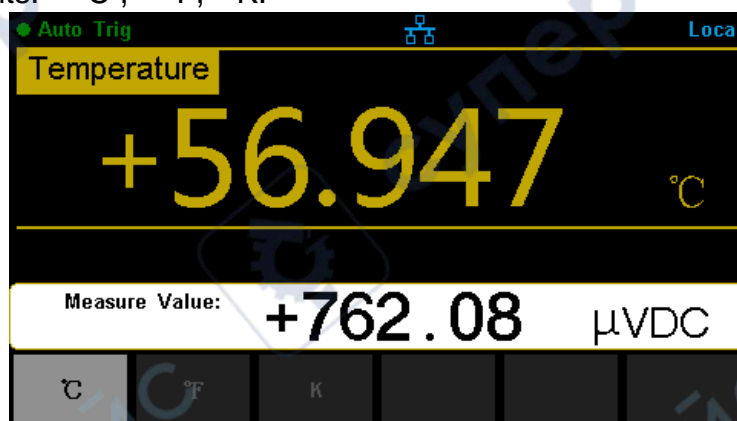

Diagram 2- 33 Unit Selection Interface

- Set relative value (Optional operation).

Press **【Rel】** to open or close Relative math function. When it is opened, the reading displayed is a value which comes from the result of actual measurement value subtracts the relative value that has been set. The default relative value is the measurement value when the function is opened. (Please refer to “Math Functions” in Chapter 2 to know about the details.)

- Read measurement result.

Temperature measurement is fixed at “Fast” rate. Therefore, you can't adjust the reading rate when reading the result.

9. View history data.

There are four types of way to view historical data: “Number”, “Bar Meter” ”Trend Chart” and “Histogram”.

Measurement Parameters

The parameters have been configured before the Multimeter leaving factory. Users can either measure directly or modify them to meet your own requirements.

DC Input Impedance

DC input impedance is only applicable for DC voltage measurement. When DC Voltage function is selected, press **【Range】** and select **【600mV】** to show the menu **【Input Z】**, as the following diagram shows.

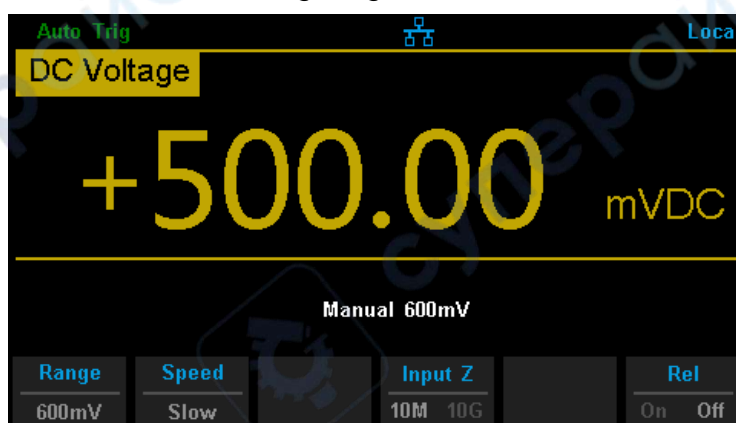

Diagram 2- 34 Choose DC Input Impedance

The options of input impedance for DC voltage measurements are $10\text{M}\Omega$ and $10\text{G}\Omega$. $10\text{M}\Omega$ impedance is general for the Multimeter, but for 600mV manual ranges, $10\text{G}\Omega$ should be chosen for better result. The current selection will be saved in nonvolatile memory.

DC input impedance selection:

- While the DC input impedance is selected as $10\text{M}\Omega$, the input impedance of all measurement range is $10\text{M}\Omega$;
- While the DC input impedance is selected to $10\text{G}\Omega$, the input impedance for 600mV is $10\text{G}\Omega$; for 2V, 20V, 200V and 1000V measurement range is kept at $10\text{M}\Omega$.
- The default value of DC input impedance is $10\text{M}\Omega$; settings of DC input impedance are stored in the nonvolatile memory.

Short-circuit Resistance

Set up the short-circuit resistance value in the short-circuit test menu. When the measured resistance is lower than the short-circuit resistance, the circuit is considered as connected, and the beeper sounds (if sound is turned on). The short-circuit resistance is only applicable to the continuity test.

Operating Steps:

1. When Continuity function is selected, press **【Threshold】** to enter interface as the following diagram.



Diagram 2- 35 Set Up the Short-circuit Resistance

2. Use direction keys to change the parameter values.
Press left and right directional keys to choose different digits. Each press for the Left key, former number will be selected, vice versa. Press up and down keys to change the current digit value. Each press for the up key, value will be increased 1, vice versa.

Short-circuit Resistance:

- The range of short-circuit resistance is $0\Omega\sim 2000\Omega$. The default value is 50Ω .
- The value of short-circuit resistance is stored in the nonvolatile memory and the resistance remains unchanged after the power is off.

Dual-display Function

Dual-display function is used to improve test and measurement functions.



Press  to open Dual-display function and the upper right corner will show "Dual". By this time, press a function key if this function can be used as the vice display, it will be displayed in the Vice Display. The Main Display will display the function that is selected before the Dual-display function is turned on. All the available combinations are listed in table 2-12.

Table 2- 12 Available Main/Vice Function Combinations (shade is available)

		Main Display Function								
		DCV	DCI	ACV	ACI	FREQ	PERIOD	2WR	4WR	Cap
Vice Display Function	DCV									
	DCI									
	ACV									
	ACI									
	FREQ									
	PERIOD									
	2WR									
	4WR									
	Cap									



Explanations:

- If the same measurement function is used in both Main and Vice Display.
 - The readings in both of the display will update at the same time.
 - If math function (dBm, dB) is used in Main Display, when opening Vice Display, math operation will be closed automatically and Vice Display will show the same measurement result as Main Display.
 - If math function (Statistics, Limits, Relative) is used in Main Display, when opening Vice Display, the result will still be shown in Main Display and Vice Display will show the same measurement result as Main Display.
- If different measurement functions are used in both Main and Vice Display.
 - The readings in both of the display will update alternately.
 - If math function (dBm, dB) is used in Main Display, when opening Vice Display, math operation will be closed automatically and Vice Display will

- show the second selected function normally.
 - If math function (Statistics, Limits, Relative) is used in Main Display, when opening Vice Display, the result will still be shown in Main Display and Vice Display will show the second selected function normally.
3. If Temperature function is used in Main Display, set the display mode ( → 【Display】 → 【All】). Then the result (corresponding value) will be shown in Main Display and the current measurement value is shown in Vice Display.
 4. Auto Range is adopted by Vice Display. If the same measurement function is used in both the display, so does the range.
 5. Measured data in Vice Display cannot be saved into “History”.

Utility Function

The Utility function enables users to set up system parameters, interface parameters of the multimeters.

Press  and  to enter the operating menu of Utility function, as the following diagram shows.

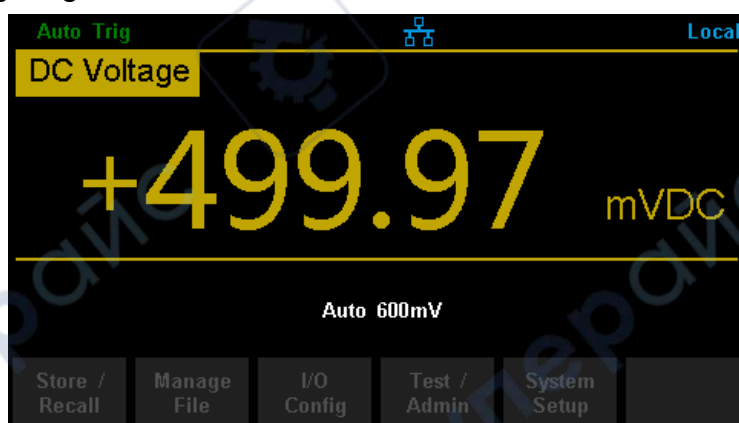

Diagram 2- 36 Utility Function Configuration Interface

Table 2- 13 Utility Function Menu Description

Function Menu	Description
Store/Recall	Store or recall setting files.
Manage File	Create a new file, copy, rename or delete a file.
I/O Config	Set up LAN and GPIB parameters.
Test/Admin	Provide board test and firmware update function.
System Setup	Set up system information configuration.

Store and Recall

The Store/Recall function enables users to store and recall the instrument parameters and data files in the local storage as well as in USB storage.

Operating Steps:

1. After entering into the function menu of Utility, press **【Store/Recall】** to enter the interface as shown in diagram 2-37.

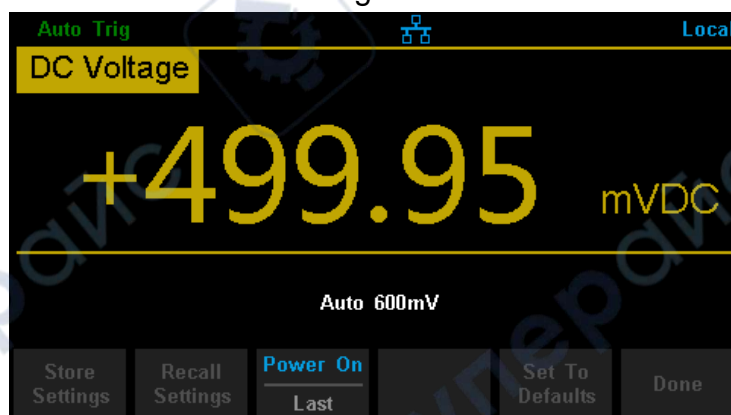

Diagram 2- 37 Store and Recall Interface

2. Press **【Store Settings】** to enter the following interface.



Diagram 2- 38 Store Settings Interface

Table 2- 14 Storage Function Menu Description

Function Menu	Settings	Description
Browse		Choose the location that file will be saved.
File Name		Input a file name.
Type	.xml / .csv	Choose the type that the file is saved.
Store MS Data		Save the file as input file name to the current selected location.
Done		Save all changes and return to the higher level menu.

3. Press **【Recall Settings】** to enter the following interface. Use direction keys to choose storage path and location, and press **【Select】** to recall the corresponding file.



Diagram 2- 39 Recall Function Interface

4. Press **【Power on】** to set the Power On state of the instrument.
- You can choose **【Last】** or **【Factory Default】** as the initial state when the instrument is turned on.
 - The configuration is effective when you restart the Multimeter.
 - DC Voltage is always the selected function when the instrument is turned on even if you have selected **【Last】** or **【Factory Default】** as the Power On state.
5. Press **【Set to Defaults】** to select “Factory Default” as the Power On state.

Manage File

The Manage File function enables users to create a new folder and save, copy, rename or delete files in the local storage as well as in USB storage.

Operating Steps:

1. After entering into the function menu of Utility, press **【Manage File】** to enter the interface as shown in diagram 2-41.

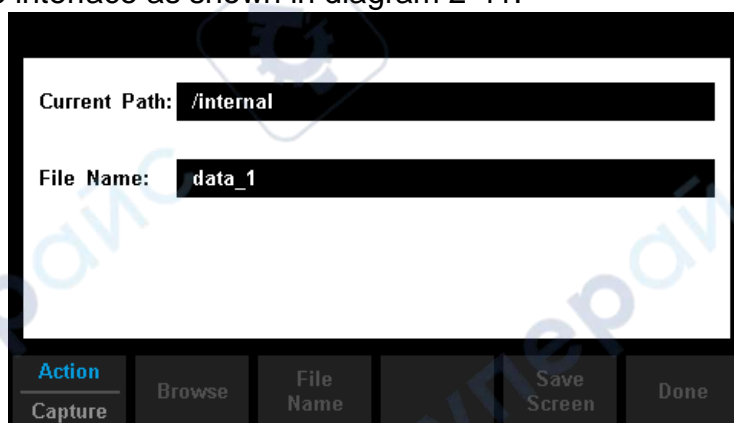

Diagram 2- 40 Manage File Interface

2. Choose the file location.
Press **【Browse】** and use direction keys to select the corresponding file.
3. Press **【File Name】** to enter the following interface.

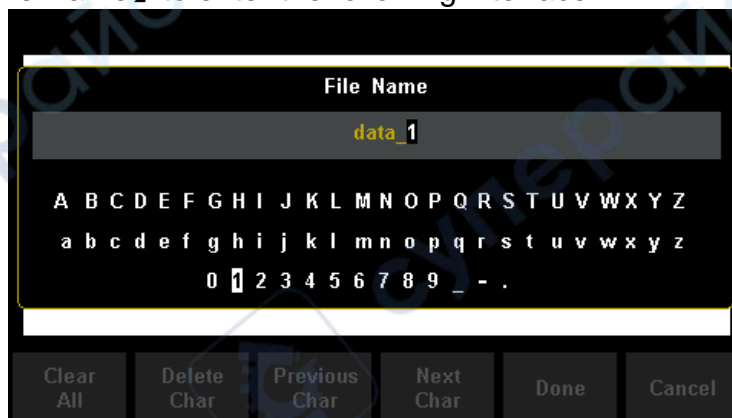

Diagram 2- 41 Input File Name

The method of inputting file name:

- Press direction keys to select a desired char in the input area.
 - Press “OK” key on the front panel to input selected char in the input area.
 - Press **【Clear All】** to clear all input chars.
 - Press **【Delete Char】** to delete the letter on which the cursor taking place.
 - Press **【Previous Char】** to move the cursor in the file name area to the previous char.
 - Press **【Next Char】** to move the cursor in the file name area to the next char.
 - Press **【Done】** to save the current file and return to the higher level menu.
 - Press **【Cancel】** to cancel the current operation and return to the higher level menu.
4. Press **【Action】** and select **【Folder】** , **【Capture Display】** , **【Copy】** , **【Rename】** or **【Delete】** to do the corresponding operation.

Table 2- 15 Action Settings

Function Menu	Description
Folder	Press 【Create Folder】 to create a new folder.
Capture Display	Press 【Save Screen】 to save current captured screen picture as standard BMP format.
Copy	Press 【Perform Copy】 to copy the selected file.
Rename	Press 【Perform Rename】 to rename the selected file.
Delete	Press 【Perform Delete】 to delete the selected file.
Done	Save all changes and return to the higher level menu.

I/O Configuration

Press **【I/O Config】** to enter the following interface and set up the parameters.

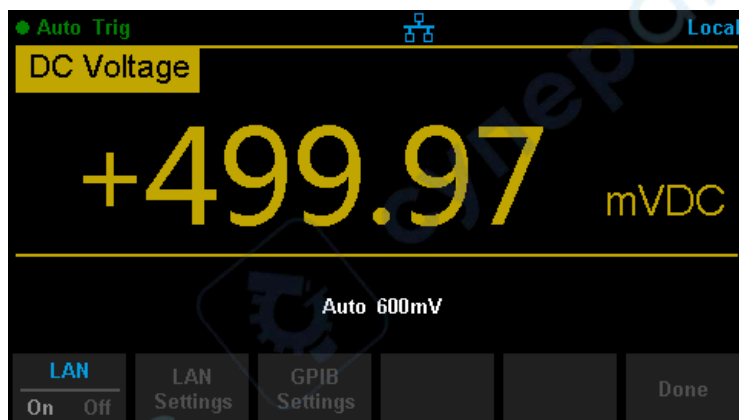

Diagram 2- 42 I/O Configuration Interface

LAN Settings

The Multimeter enables users to operate instrument remotely by LAN interface and store or recall internet settings. You can look over current LAN settings and set up IP address and subnet mask.

After entering into the function menu of Utility, press **【I/O Config】**. Select **【On】** → **【LAN Settings】** → **【Modify Settings】** to enter the following interface.

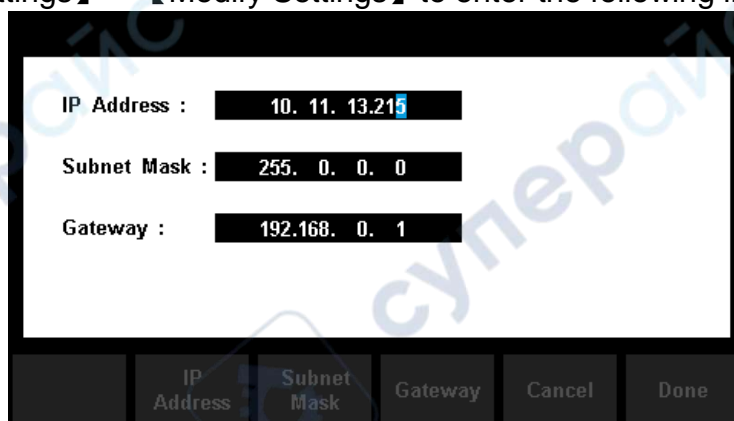

Diagram 2- 43 LAN Settings Interface

Table 2- 16 LAN Settings

Function Menu	Description
IP Address	Set up IP address and the default setting is 10. 11. 11. 104.

Subnet Mask	Set up subnet mask and the default setting is 255. 0. 0. 0.
Gateway	Set up gateway and the default setting is 192.168.0.1
Cancel	Cancel current operation and return to the higher level menu.
Done	Save all changes and return to the higher level menu.

GPIB Settings

Each device on the GPIB (IEEE–488) interface must have a unique address. The default address is 18 when the instrument is leaving the factory. The address of Multimeter can be any integral value between 1 and 30.

Operating Steps:

1. After entering into the function menu of I/O configuration, press **【GPIB Settings】** to enter the interface shown in diagram 2-45.

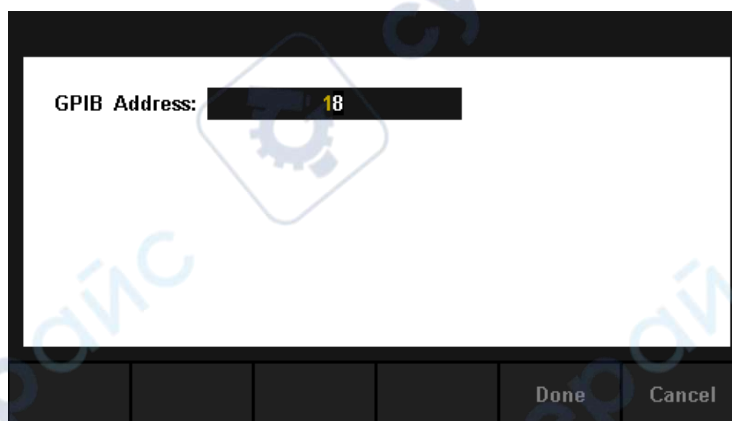

Diagram 2- 44 GPIB Settings

2. Users can change the value of GPIB address by direction keys.
3. Press **【Select】** to set the input value as GPIB address and return to the higher level menu.

Board Test

SDM3045X provides self-test functions, including Key Test, LCD Test, Beeper Test and Chip Test.

Operating Steps:

1. Press **Shift** and **Dual**, then choose **【Test/Admin】** → **【Board Test】** to enter the following interface.

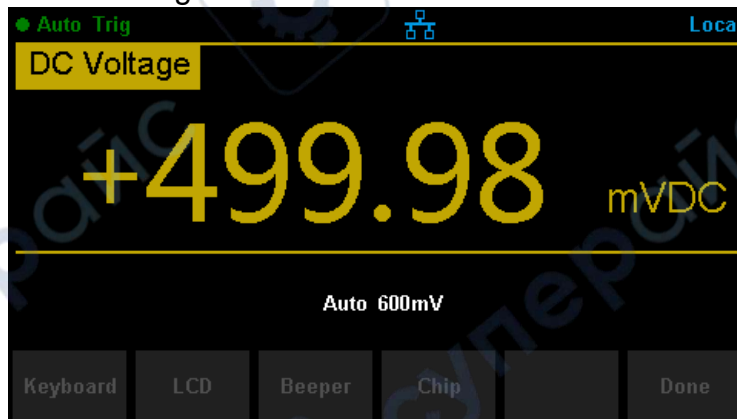

Diagram 2- 45 Board Test Interface

Table 2- 17 Board Test Function Description

Function Menu	Description
Key	Test the instrument's keys.
LCD	Test the instrument's LCD screen.
Beeper	Test the instrument's beeper.
Chip	Test the instrument's chips.
Done	Return the higher level menu.

2. Test the keys.

Select **【Key】** to enter the key test interface, as the Diagram 2-47 shows. The on-screen lathy rectangle shapes represent the keys on the front panel. Test all keys and knobs and you should also verify that all the backlit buttons illuminate correctly.

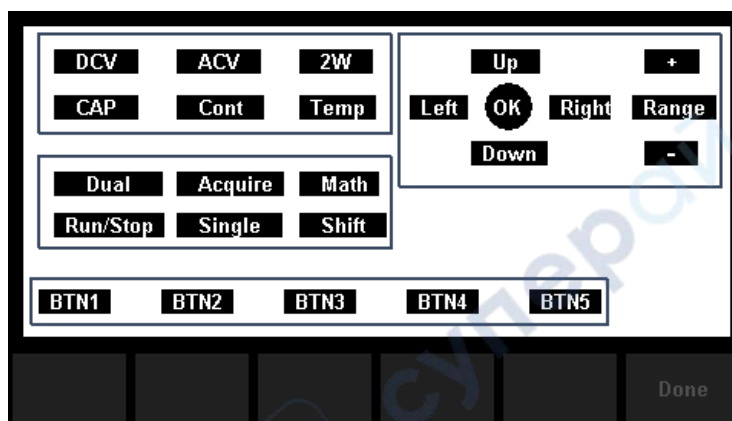

Diagram 2- 46 Key Test Interface

NOTE:

- Before you operate, the shapes on the screen display blue color.
- The corresponding area of tested buttons or knobs would display green color.
- Press **【Done】** to exit the test.

3. Test the LCD screen.

Select **【LCD】** to enter the screen test interface, the screen shows the message: "Press 'Change' to change Press 'Done' to exit". Press **【Change】** to start the test and observe if the screen has severe color or other display error. As the Diagram 2-48 shows.

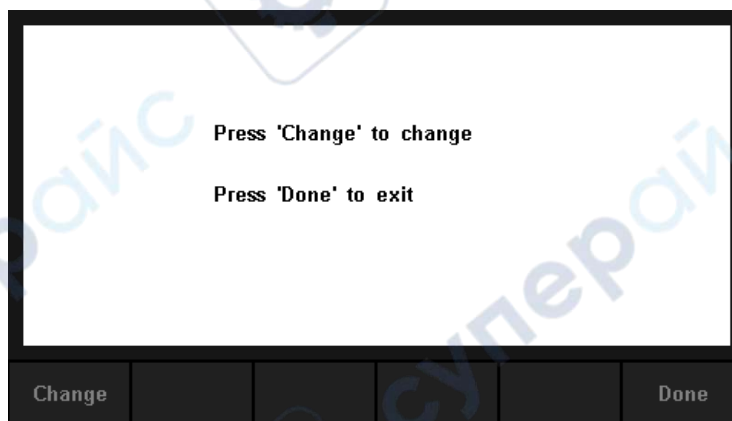

Diagram 2- 47 LCD Test Interface

NOTE:

- Press **【Change】** to change the color of the screen. There are three colors: red, blue and green.
- Press **【Done】** to exit the test.

4. Test the beeper.

Press **【Beeper】** to test the beeper. Under regular circumstance, press **【Beeper】** one time and the instrument will beep one time.

5. Test the chips.

Press **【Chip】** → **【Start】** to enter chip test interface, as Diagram 2-49 shows.

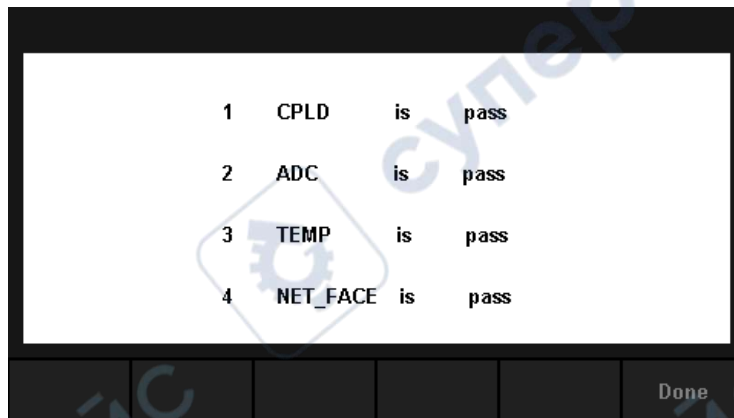

Diagram 2- 48 Chip Test Interface

NOTE:

- If the test is passed, the corresponding result shows “pass”.
- If the test is failed, the corresponding result shows “fail”.

6. Press **【Done】** to exit the board test.

System Setup

Press **Shift** and **Dual** , then select **【System Setup】** to enter the following interface.

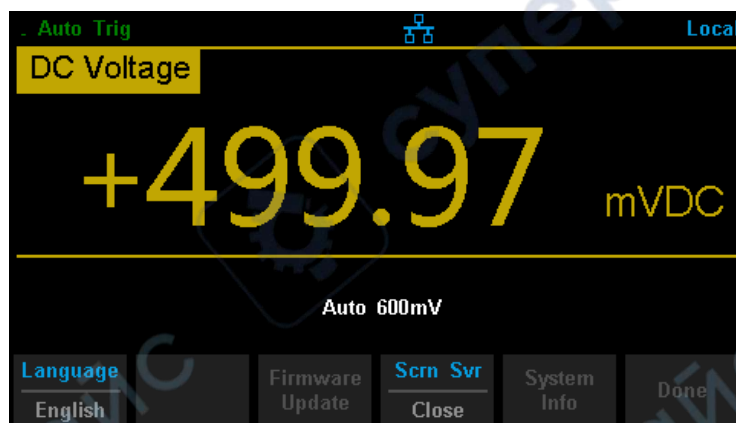

Diagram 2- 49 System Setup Interface

Table 2- 18 System Settings Menu Description

Function Menu	Description
Language	Select the display interface language.
Firmware Update	Update software version,
Screen	Set up the screen protection function.
System Info	View system information.
Done	Return to the higher level menu.

1. Select language.

The Multimeter supports two kinds of languages, English and Chinese. Press **【Language】** to enter the following interface.

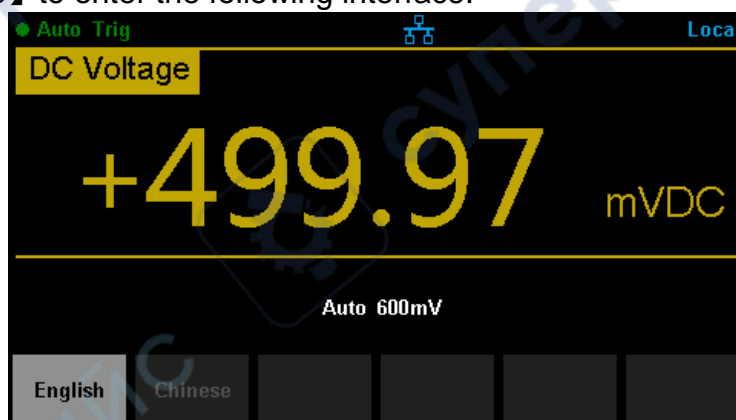

Diagram 2- 50 Choose Language

2. Set up the time of screen protection.

Press **【Screen】** to set screen protection as 1 Min, 5 Mins, 15 Mins, 30 Mins, 1 Hour, 2 Hours or 5 Hours according to different demands. Activate the screen saver program and screen saver will be on if no action is taken within the time that you have selected. Press any button the resume.

3. View system information.

Press **【System Info】** to view system information, including startup times, software version, hardware version, production ID and serial number, as shown in the following diagram.

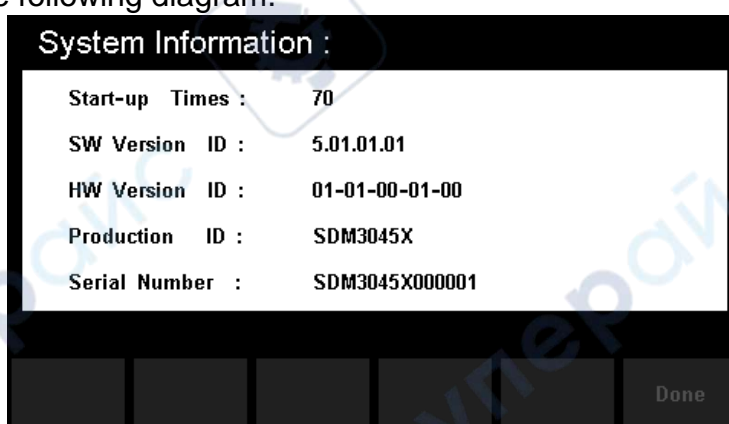





Diagram 2- 51 System Information

Firmware Update

The software of the Multimeter can be updated directly via USB flash drive, updating current software version to desired software version.

Operating Steps:

1. Copy the update file to the USB flash drive.
2. Insert USB flash drive to USB host interface on the front panel of the Multimeter.
3. Press  →  → **【System Setup】** → **【Firmware Update】**, then press **【Browse】** and select the update file. Next, press **【Update】** → **【Yes】** to start updating the system software.
4. After accomplishing update, the screen shows message: "Firmware Update Done!" Then you can move the USB flash drive away.
5. Restart the Multimeter and check the version information.
Press  →  → **【System Setup】** → **【System Info】** to check if the software and hardware version after updating is in accordance with the desired version. If not, the updating is failed and you need update once more as the above steps.
6. After checking, press **【Done】** to exit the system information interface.

NOTE:

Don't cut off the power during the instrument is updating

Acquire

Sampling is a process of acquiring and digitizing signal. The optional Trigger methods of the Multimeter include Auto Trigger, Single Trigger and External Trigger.

Press  to enter the interface shown as the following diagram:

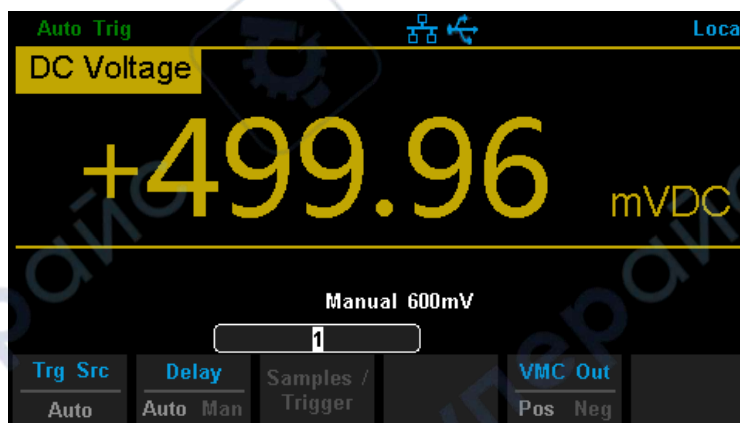

Diagram 2- 52 Acquire Interface



Table 2- 19 Function Menu of triggering parameter

Function Menu	Description
Trg Src	Set the source of trigger.
Slope	Set the slope polarity of external trigger.
Delay	Set the delay.
Samples/Trigger	Set the number of samples or trigger.
VMC Out	Set the polarity of output pulse signal when sampling signal is finished.

Auto Trigger

Auto Trigger parameters that need to be set up include delay, samples/trigger and VMC out.

Operating Steps:

1. Press  , then select **【Trg Src】**→**【Auto】** or press  on the front panel directly to enable Auto Trigger.

2. Set the delay.

Delay is the waiting time after the trigger signal is sent out and before the acquiring starts. Press **【Delay】** to select Auto or Manual mode. When choosing Manual mode, Left and Right keys are used to switch the number of a numerical value, Up and Down keys are used to change the selected value.

3. Set the number of samples or trigger.

Press **【Samples/Trigger】** to set the sample count. Left and Right keys are used to switch the number of a numerical value, Up and Down keys are used to change the selected value.

Sample Count

- Sample Count indicates the count of point sampled while the Multimeter getting a signal of Single Trigger.
- The range of sampling point should be between 1 and 599999999.
- The default value of Sample Count is 1.

4. Set the VMC Out.

The Multimeter output a pulse signal through the VM COMP interface on the rear panel after sampling signal is finished

Press **【VMC Out】** to choose Positive or Negative polarity.

Single Trigger

Single Trigger parameters that need to be set up include delay, samples /trigger and VMC out.

Operating Steps:

1. Press **Acquire**, then select **【Trg Src】** → **【Single】** or press **Single** on the front panel directly to enable Single Trigger. See the diagram below.

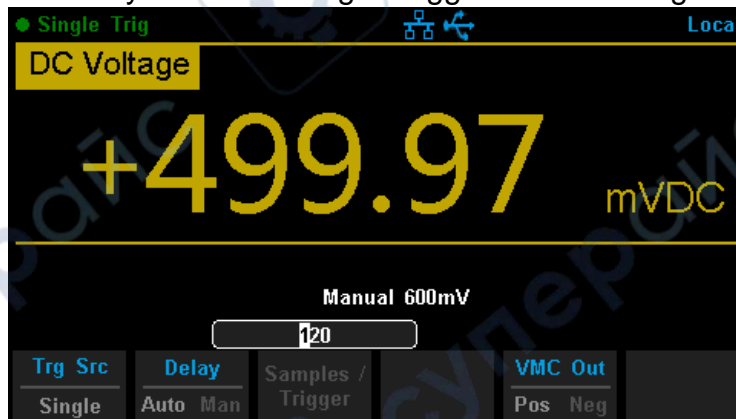

Diagram 2- 53 Setting interface of Auto Trigger

2. Set the delay.
Press **【Delay】** to select Auto or Manual mode.
3. Set the number of samples or trigger.
Press **【Samples/Trigger】** to set sample count.

4. Set the VMC Out.

The Multimeter output a pulse signal through the VM COMP interface on the rear panel after sampling signal is finished.

Press **【VMC Out】** to choose Positive or Negative polarity.

External Trigger

The external trigger signal will be input via EXT TRIG interface on the rear panel. External trigger parameters that need to be set up include delay, samples /trigger, slope and VMC out.

Operating Steps:

1. Press  , then select **【Trg Src】**→**【Ext】**to enable External Trigger.





Diagram 2- 54 Setting interface of Ext Trigger

2. Set the polarity of slope.
Press **【Slope】** to choose Positive or Negative polarity.
3. Set the delay.
Press **【Delay】** to choose Auto or Manual mode.
4. Set the number of samples or trigger.
Press **【Samples/Trigger】** to set sample count.
5. Set the VMC Out.
In External Trigger mode, the Multimeter could output a pulse signal through the VM COMP interface on the rear panel after sampling signal is finished.

Help System

SDM3045X provides powerful built-in help system. You can recall help information at any time during using the instrument. You also can get a particularly help for every button on the front panel or menu softkey by using the built-in help system. Or you can get help about familiar operations with the help list.

Press  and  to enter the help list, as the following diagram shows.

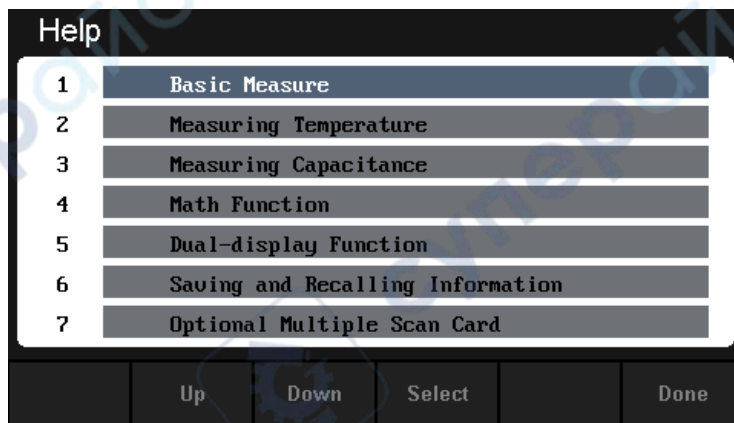

Diagram 2- 55 Help Menu

Table 2- 20 Help System Operating Menu

Function Menu	Description
Up	Move up the cursor and select the help menu.
Down	Move down the cursor and select the help menu.
Select	Select the help information you want and read it.
Done	Return to the higher menu.

1. Basic Measure.

Get basic measurement types and methods to connect the leads in different measurements.

2. Measuring Temperature.

Get the method to measure temperature.

3. Measuring Capacitance.

Get the method to measure temperature.

4. Math Function.

Introduce how to use the math function while you are measuring.

5. Dual-display Function.

Get the method to use the dual-display function while you are measuring.

6. Saving and Recalling Information.

Introduce how to store and recall the data/parameter/ sensors files.

7. Optional Multiple Scan Card.

Get help about operating optional multiple scan cards.

8. The convention and Tips of Softkeys.

Get help about the convention and tips of softkeys.

9. Technical Support.

Get the method to obtain technical support.

Explanation:

- In the help menu interface, you also can move cursor and select the corresponding menu by up and down direction keys and press "OK" to read the help information.
- While reading help information, you also can look up and down the information by up and down direction keys.

Math Function

The Multimeter provides five math functions: Statistics, Limits, dBm, dB and Relative. Choose different math functions to meet different measurement demands.

Press  to show the operating menu of math functions on the screen, as shown in the following diagram.

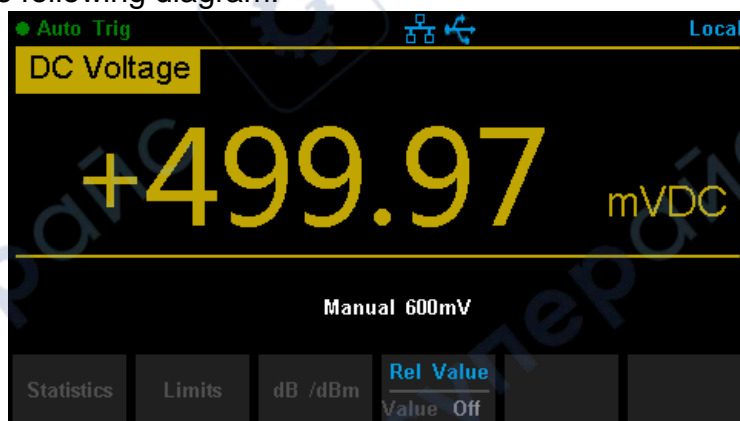

Diagram 2- 56 Math Function Menu of DC Voltage

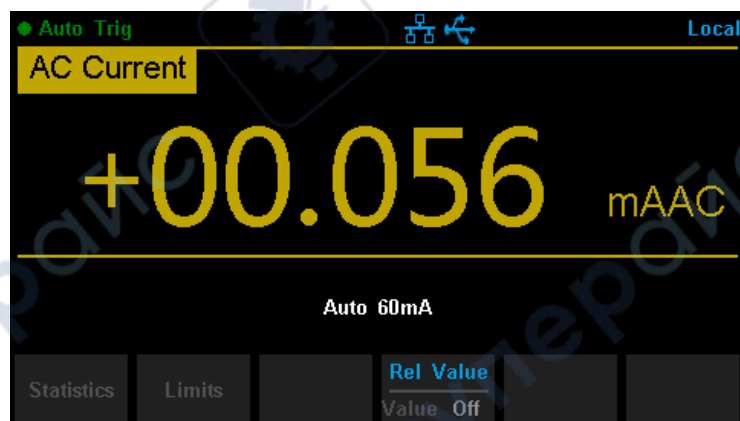

Diagram 2- 57 Math Function Menu of AC Current

Table 2- 21 Math Function Menu Description

Function Menu	Settings	Description
Statistics		Reading statistic functions, including: max, min, average, span, std dev and samples.
Limits		The Limits function performs Pass/Fail testing according to the specified upper and lower limits.
dBm		The dBm is based on a calculation of power delivered to a reference resistance, 0dBm = 1mW.
dB		The dB measurement is the difference between the input signal and a stored relative value.
Rel Value	Value/Off	Turn on the relative value function and set up the value. Or turn off the function.

Explanations:

- Math function can only be applicable to the main display.
- If measurement function is changed, all math functions will be closed except Statistics.

Statistics

There are many kinds of reading statistic functions, including: Max, Min, Average, Standard deviation and so on.

Press  → **【Statistics】** → **【Show】** to enter the interface shown in the following diagram.

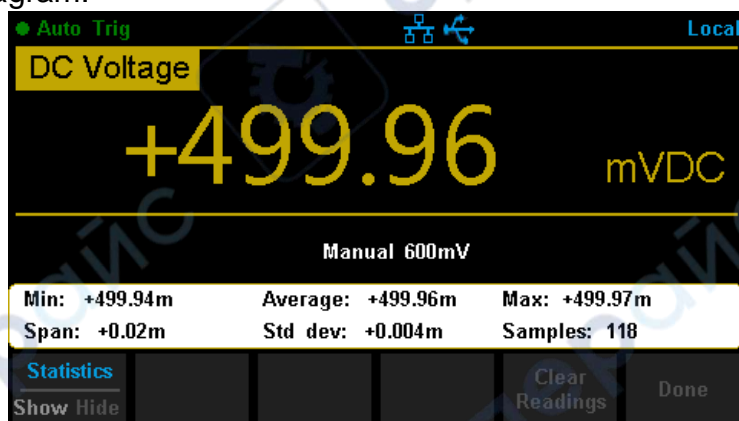

Diagram 2- 58 Statistics

Table 2- 22 Statistic Measurement Menu Function Description

Function Menu	Settings	Description
Statistics	Show/Hide	Show or hide the statistics function interface.
Min		Show the minimum statistics value of current measurement.
Average		Show the average statistics value of current measurement.
Max		Show the maximum statistics value of current measurement.
Span		Show the span of current measurement.
Std dev		Show the std dev statistics value of current measurement.
Samples		Show the maximum statistics value of current measurement.
Clear Readings		Clear all current readings and restart statistics.
Done		Return to the higher level menu.

Statistics Function:

- In statistic function, the first reading is usually set to the maximum or minimum value. When getting more readings, current displaying value is always the maximum/minimum reading among all the measured values.
- The maximum, minimum, average and reading quantities are stored in volatile memory.

Limits

Limits function is available to prompt signals beyond ranges according to the upper and lower parameters.

Press  → **【Limits】** → **【On】** to enter the interface shown in the following diagram.

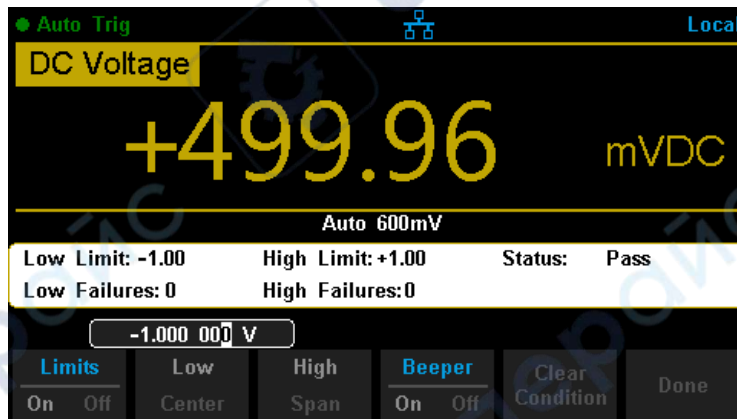

Diagram 2- 59 Limits

Table 2- 23 Limits Measurement Menu Function Description

Function Menu	Settings	Description
Limits	On/Off	Turn on or turn off the Limits function.
Low		Set the desired lower limit.
Center		Set the desired center value
High		Set the desired upper limit.
Status		Show the status of limit test.
Low Failures		Show the times that reading is lower than the limit.
High Failures		Show the times that reading is higher than the limit.
Span		Set the desired span.
Beeper	On/Off	When the beeper is on, if the reading is lower or higher than limits, the instrument will beep once.
Clear Condition		Clear all current readings and restart to test.
Done		Save all changes and return to the higher level menu.

1. How to Set Limits

Select **【High】**, **【Low】**, **【Center】** or **【Span】** and then switch to the needed digit by Left or Right Direction keys and input numerical value by Up and Down Direction keys.

2. Unit

The unit of Limits is decided by the current measurement function.

3. Over hint

- When the reading is lower than the set lower limit, the color of main display will switch black to red.
- When the reading is higher than the set higher limit, the color of main display will switch black to red.
- When the reading is lower or higher than the set limits, the Beeper will beep once. (The beeper is turned on.)

The range of Limits function:

- The upper limit value should be always bigger than the lower limit value.
- The upper and lower values are stored in volatile memory. They will be set to default values when the power is on.

dBm

The dBm function is logarithmic and based on a calculation of power delivered to a reference resistance, relative to 1 mill watt. Besides, this function only applies to AC voltage and DC voltage measurements.

Press  → **【dB/dBm】** → **【On】** and select **【Function dBm】** to enter the interface shown in the following diagram.



Diagram 2- 60 dBm Function Interface

Table 2- 24 dBm Measurement Function Menu Function Description

Function Menu	Settings	Description
dB/dBm	On/Off	Turn on or turn off dB or dBm function.
Function dBm		Open dBm function and the lower right corner of the main display show “dBm”.
Ref R		Set the parameter via direction keys: 50Ω ~ 8000Ω.
Done		Save all changes and return to the higher level menu.

The computation method of the dBm:

When dBm function is turned on, the measured value of voltage is transformed into dBm according to the following formula.

$$\text{dBm} = 10 \times \text{Log}_{10} [(\text{Reading}^2 / R_{\text{REF}}) / 0.001\text{W}]$$

dB

Each dB measurement is different between the input signal and a stored relative value, with both values converted to dBm. The dB function applies to AC voltage and DC voltage measurements only.

Press **Math** → **dB/dBm On** and select **Function dB** to enter the interface shown in the following diagram.

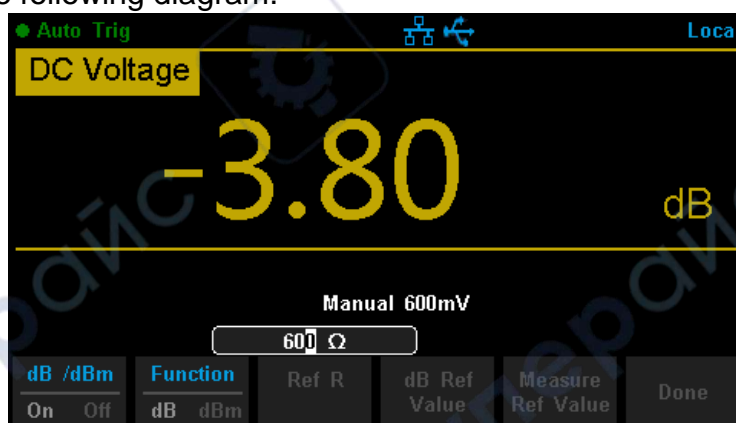

Diagram 2- 61 dB Function Interface

Table 2- 25 dB Measurement Function Menu Function Description

Function Menu	Settings	Description
dB/dBm	On/Off	Turn on or turn off dB or dBm function.
Function dB		Open dB function and the lower right corner of the main display show “dB”.
Ref R		Set the parameter via direction keys: 50Ω ~ 8000Ω.
dB Ref Value		Set the referred value of dB.
Measure Ref Value		Set the current dBm measurement value as referred value.
Done		Save all changes and return to the higher level menu.

The computation method of the dB:

$$dB = 10 \times \text{Log}_{10} [(Reading^2 / R_{REF}) / 0.001W] - (dB \text{ Ref value})$$

R_{REF} expressed measuring the resistance value in the actual electric circuit.

Range of the dB Ref value: -200 dBm ~ +200 dBm. The default is 0 dBm.

dB Ref value:

- Input a value in dB setting interface by direction button, and then store it as dB Ref value.
- Settings of dB Ref value are stored in volatile memory.

Relative Value

Relative value is used for relative measurement. Actual measurement reading is the depression between measurement value and preset value.

The Multimeter allows operating for the following parameters: DC Voltage, AC Voltage, DC Current, AC Current, Resistance, Frequency, Period, Capacitance and Temperature.

Press  → **【Rel Value】** to enter the interface shown in the following diagram.

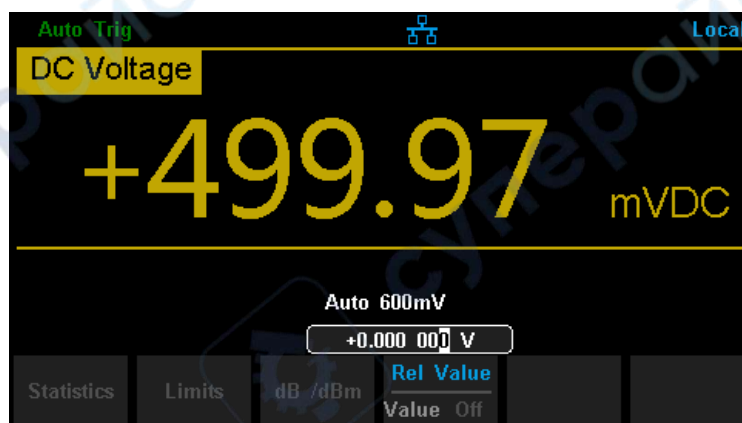

Diagram 2- 62 Relative Operation

Table 2- 26 Rel Value Operation Function Menu

Function Menu	Description
Value	Select current measurement value as preset value.
Off	Turn off the relative operation function.

When Rel Value function is turned on, the result of relative measurement will show on the screen.

Main display = Measurement value – Preset value

Display Mode

The Multimeter supports four types of way to view measured data: “Number”, “Bar Meter”, “Trend Chart” and “Histogram”.

Number

Press **Shift** and **Math** to open the menu of display mode and press **Display** to enter the following interface. “Number” is always the selected mode when the Multimeter is turned on.

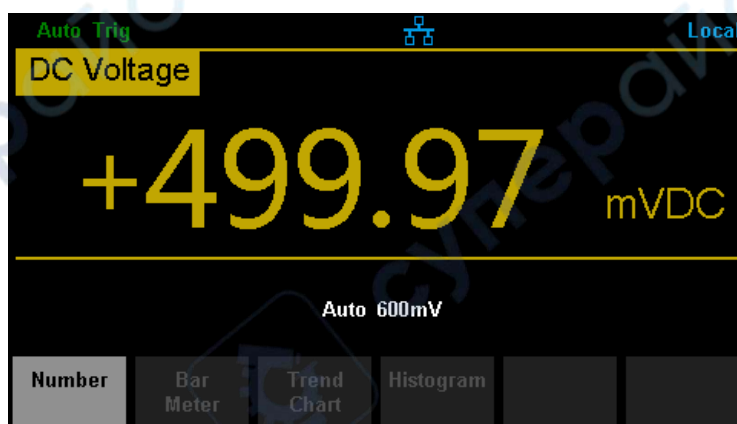

Diagram 2- 63 Number Display Mode

Bar Meter

Operating Steps:

1. Press **【Bar Meter】** to enter Bar Meter display mode.

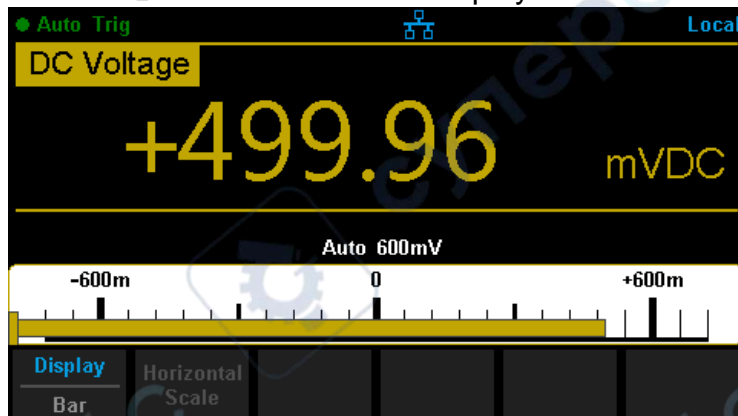

Diagram 2- 64 Bar Meter Display Mode

2. Press **【Horizontal Scale】** to choose the way to set the vertical scale as Default , Manual mode or Limits (limit function is on).

Table 2- 27 To Set the Vertical Scale of Bar Meter manually

Function Menu	Description
Low	Set the low value of horizontal scale.
High	Set the high value of horizontal scale.
Center	Set the center value of horizontal scale.
Span	Set the span of horizontal scale.
Done	Save all changes and return to the higher level menu.

Trend Chart

Operating Steps:

1. Press **【Trend Chart】** to enter Trend Chart display mode.

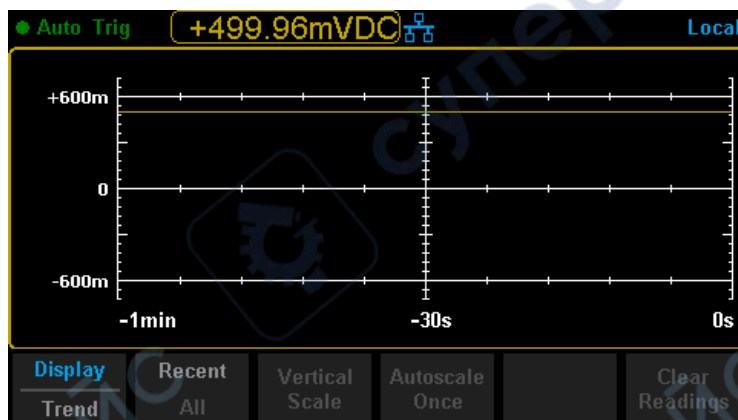

Diagram 2- 65 Trend Chart Display Mode

Table 2- 28 Trend Chart Display Mode

Function Menu	Description
Display Trend	Currently selected display mode is Trend Chart.
Recent All	Show recent or all readings.
Horizontal Scale	Choose the mode of Horizontal Scale.
Autoscale Once	Automatically set the horizontal scale once.
Clear Readings	Clear all current readings and restart statistics.

2. Press **【Horizontal Scale】** to choose the way to set the horizontal scale as Default , Auto , Manual or Limits (Limit function is on) mode.
Press **【Auto】** and the Multimeter will set the vertical scale automatically.

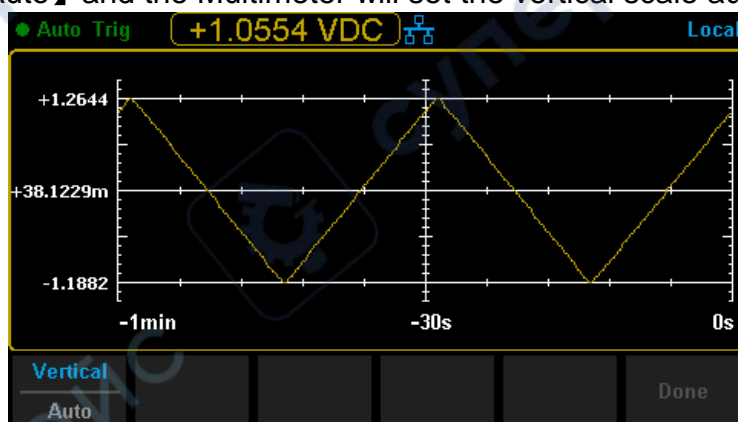

Diagram 2- 66 Auto Vertical Scale

Press **【Manual】** and you can set the vertical scale manually, as the following diagram shows.

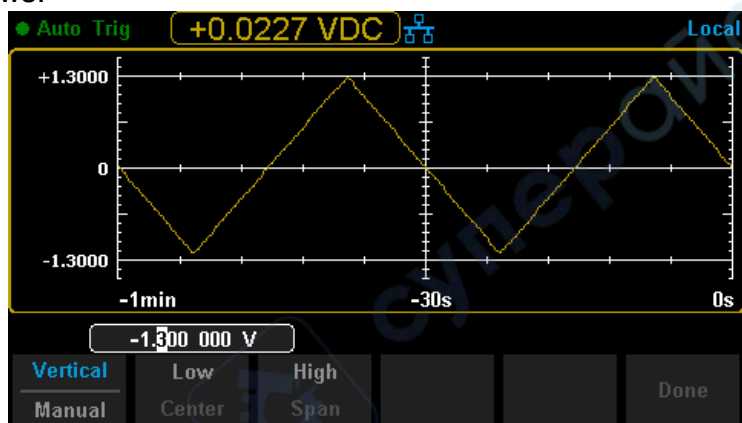

Diagram 2- 67 Manual Vertical Scale

Histogram

Operating Steps:

1. Press **【Histogram】** to enter Histogram display mode.

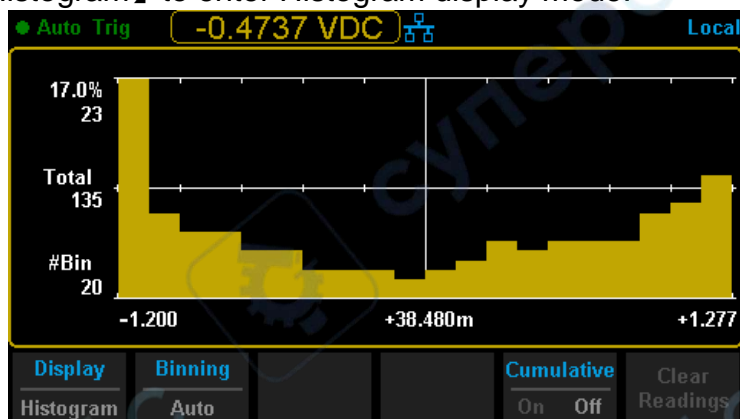

Diagram 2- 68 Histogram Display Mode

Table 2- 29 Histogram Display Mode

Function Menu	Settings	Description
Display Histogram		Currently selected display mode is Histogram.
Binning		Set Binning as Auto or Manual mode.
Bin Set		Set the parameters of Bin.
Cumulative	On/Off	Turn on or off Cumulative function.
Clear Readings		Clear all current readings and restart statistics.

2. Press **【Binning】** to choose the way to set Binning as Auto or Manual mode. When in Manual mode, press **【Bin Settings】** to enter the following interface.

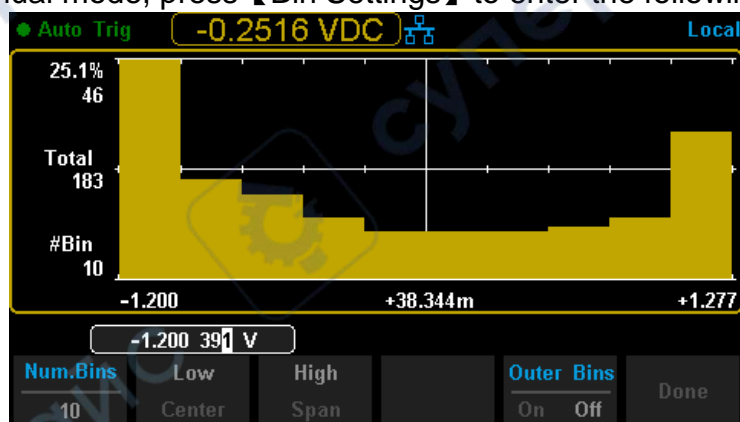



Diagram 2- 69 Bin Set Interface

Table 2- 30 Bin Set

Function Menu	Settings	Description
Num.Bins		Set the number of Bins, 10, 20, 40, 100, 200 or 400 selected.
Low		Set the low value of horizontal scale.
High		Set the high value of horizontal scale.
Center		Set the center value of horizontal scale.
Span		Set the span of horizontal scale.
Outer Bins	On/Off	Show the bins beyond the scope or not.
Done		Save all changes and return to the higher level menu.

Trigger

The Multimeter supports Trigger function. Press  or  on the front panel to trigger the Multimeter by Auto or Single mode. Auto trigger is considered as a default when the power is on.

Auto Trigger

Press  on the front panel one time and Auto Trigger will be started to capture continuous readings automatically. By the time, the black field of the screen will show “● **Auto Trigger**”. Press  again and the trigger is stopped.

Single Trigger



Press  on the front panel, Single Trigger will be started one time and generate an effective reading. By the time, the black field of the screen will show “● **Single Trig**”.

Explanation:

In Remote Mode, the black field just above the screen will show “● **Immediate Trig**”. Press  to switch back to the local mode and the Multimeter will choose Auto Trigger automatically.

Hold Measurement Function

Hold Measurement function provides users with a stable reading on the screen of the front panel. When the test leads are put away, the reading is still held on the screen, which makes users can view measured history data.

Press  and  to open Hold measurement function interface, the black field just above the screen will show “● Probe Hold”, as shown in the following diagram.

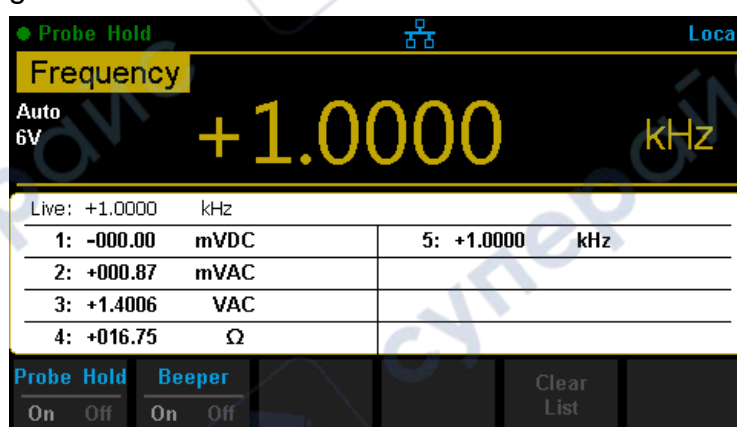

Diagram 2- 70 Hold Measurement Function Interface

Table 2- 31 Hold Measurement Function

Function Menu	Settings	Description
Probe Hold	On/Off	Turn on or off Probe Hold function.
Beeper	On/Off	Turn on or off the Beeper.
Clear List		Clear all current readings and restart to statistics.

Chapter 3 Application Examples

This chapter mainly introduces few application examples to help users control and manipulate SDM3045X quickly.

- **Example 1: Reading Statistic Functions**
- **Example 2: To Eliminate Leads Impedance**
- **Example 3: dBm Measurement**
- **Example 4: dB Measurement**
- **Example 5: Limits Test**
- **Example 6: To Use Hold Measurement Function**

Example 1: Reading Statistic Functions

Introduce how to realize the statistic function during measuring. When continually measuring few readings, the Multimeter will update statistic values constantly.

Operating Steps:

1. Press  on the front panel to select AC Voltage measurement function and choose a proper voltage range.
2. Connect the red lead to terminal Input-HI and black lead to terminal Input-LO as Diagram 2-9.
3. Set the Statistics function parameters.

Press  → **【Statistics】** to turn on the statistics function.

4. Lead test leads into the circuit and start to measure. Statistics will update with the increasement of samples, as the following diagram shows.

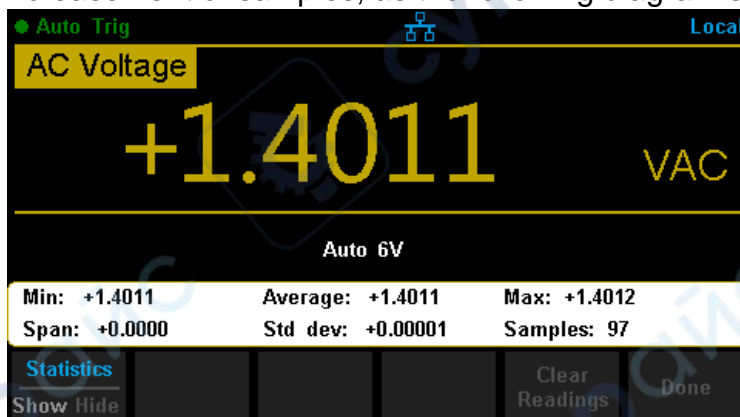

Diagram 3- 1 Statistics 1

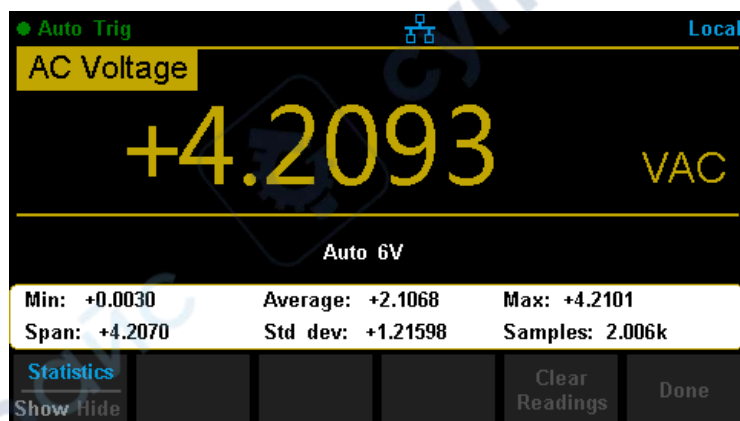



Diagram 3- 2 Statistics 2

Example 2: To Eliminate Leads Impedance

Relative Operation could eliminate impedance errors from leads when measuring smaller resistance.

Operating Steps:

1. Press  on the front panel to select 2-Wire Resistance measurement function.
2. Connect the red lead to terminal Input-HI and black lead to terminal Input-LO as Diagram 2-14.
3. Choose a proper resistance range according to the scope. The default is Auto Range.
4. Lead impedance will be shown on the screen as follow after connecting with two leads together.

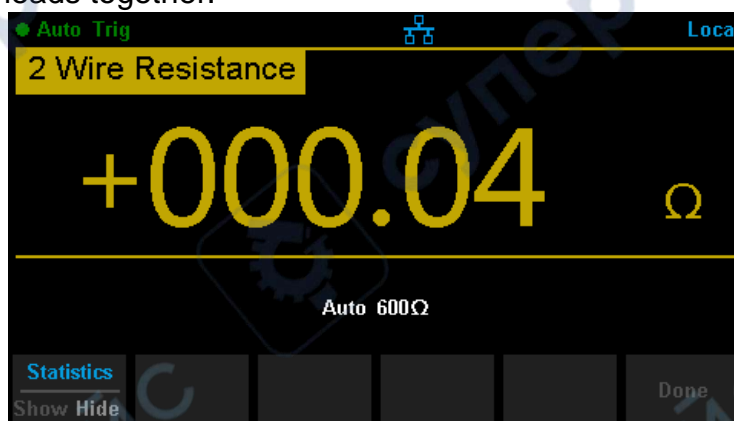

Diagram 3-3 Test Lead Impedance

5. Set parameters for Relative operation.

Press  → **【Rel Value】** set relative value as current measured value.

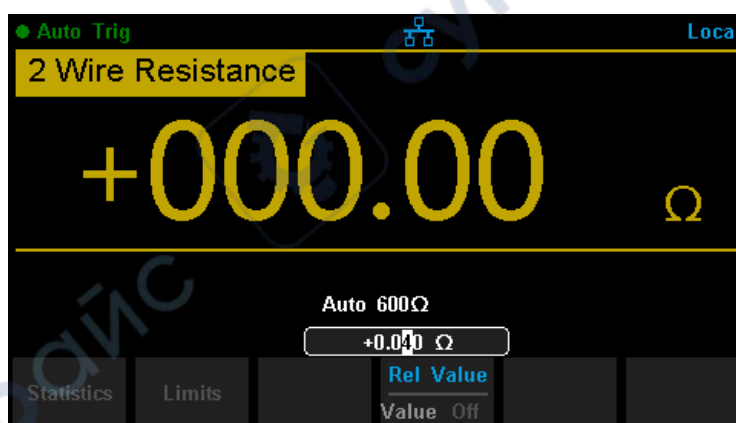
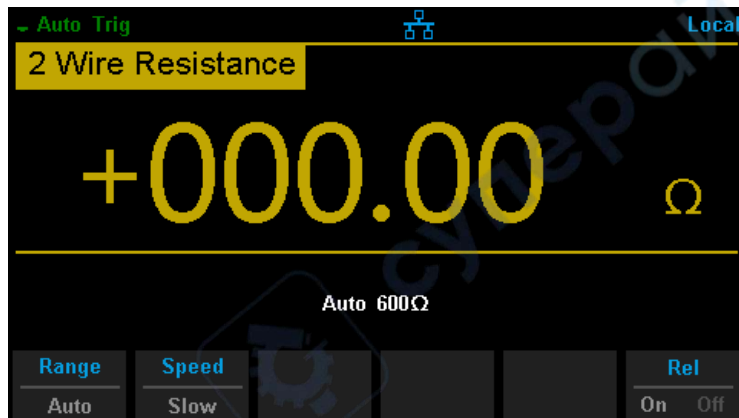

Diagram 3-4 Set Relative Value

6. Besides, pressing **【Rel】** on the softkey menu could also open Relative operation.



The Relative Operation has been turned on.

Diagram 3- 5 Lead Impedance after Operation

Example 3: dBm Measurement

dBm is commonly used in audio signal measurement. The following will introduce you how to measure dBm value.

Operating Steps:

1. Press  on the front panel to select AC Voltage measurement function and choose a proper voltage range.
2. Connect the red lead to terminal Input-HI and black lead to terminal Input-LO as Diagram 2-9.
3. Set the dBm parameters.

Press  → **【dB/dBm】** to turn on the dBm function and set the selective value of dBm as a reference value within supposed circuit by using direction keys: 50Ω .



Diagram 3- 6 Select Reference Resistance as Measurement Value

Example 4: dB Measurement

As a common measuring unit, dB has been widely used in electrical engineering, radio science, mechanics, shock and vibration, mechanical power and acoustics areas. The following will introduce you how to measure dB between two circuits.



Operating Steps:

Method 1:

Measure dBm_1 and dBm_2 existing in two circuits separately according to Example 3, and then dB could be got:

$$\text{dB} = \text{dBm}_1 - \text{dBm}_2$$

Method 2:

1. Press  on the front panel to select AC Voltage measurement function and choose a proper voltage range.
2. Connect the red lead to terminal Input-HI and black lead to terminal Input-LO as Diagram 2-9.
3. Measure dBm_1 according to Example 3.
4. Press  → **【dB/dBm】** to turn on the dB function and Set parameters of dB Ref Value (dBm_2). At this time, the reading shown on the screen is the power difference between two circuits.

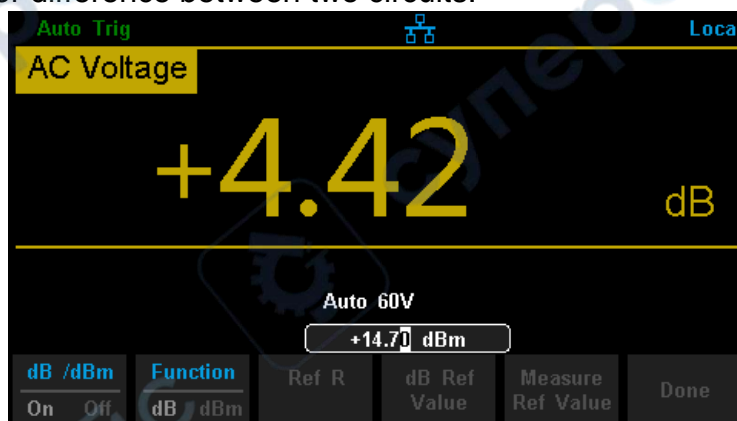



Diagram 3- 7 Set the Parameters of dB Ref Value



Method 3:

1. Access the first circuit. Measure dBm2 according to Example 3.
2. Press  → **【dB/dBm】** to turn on the dB function and select **【Measure Ref Value】** to set the current dBm measurement value as referred value.
3. Access the first circuit. At this time, the reading shown on the screen is the power difference between two circuits.

Example 5: Limits Test

Limits Operation hints you the signal is overstep its range according to the selected High and Low Limit parameters; meanwhile the beeper makes a sound to alarm (if sound is on.)

Operating Steps:

1. Press  on the front panel to select AC Voltage measurement function and choose a proper voltage range.
2. Connect the red lead to terminal Input-HI and black lead to terminal Input-LO as Diagram 2-9.
3. Press  → **【Limits】** to set the Limits parameters.
Press **【Low】** to set the low limit value.

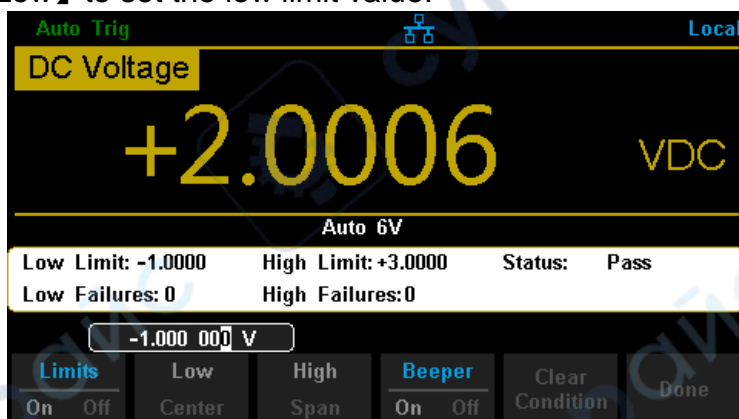

Diagram 3- 8 Set the Low Limit Value

Press **【High】** to set the high limit value.

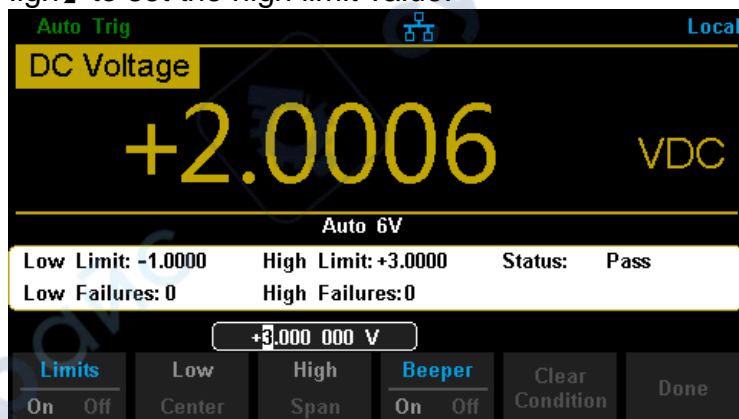

Diagram 3- 9 Set the High Limit Value

4. Turn on the beeper and start Limits Test. As shown in Diagram 3-11. The measured result is between the Low and High limits, so the test status is “Pass”.
5. If changing the high limit value to 2V, the measured result is not between the Low and High limits. So the instrument beep once, and the main display is red. The test status is “Fail” and High Failures is shown. As the following diagram shows.

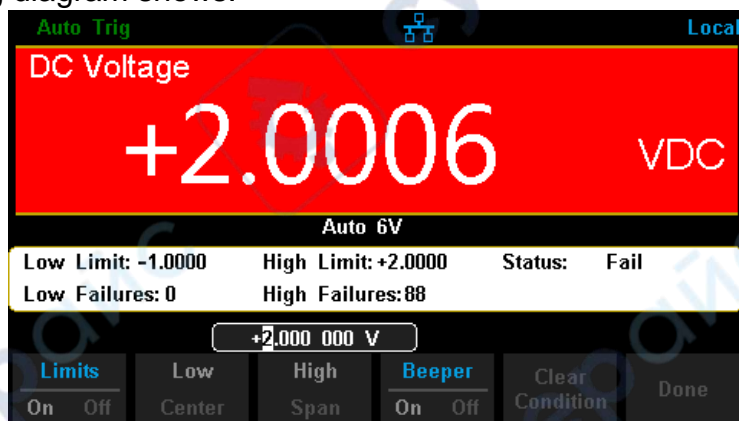

Diagram 3- 10 Limits Test Result

Example 6: To Use Hold Measurement Function

Reading Hold can help user to obtain a stable reading and hold it on the display of Front Panel. The reading would be held all the same although testing pen had been moved away. Then we will introduce how to keep the readings displayed on screen.

Operating Steps:





1. Press  on the front panel to select DC Voltage measurement function and choose a proper voltage range.
2. Connect the red lead to terminal Input-HI and black lead to terminal Input-LO as Diagram 2-4.
3. Press  and  to open Hold measurement function interface. By the time, the screen will record the result of measuring DC voltage, as shown in the following diagram.



Diagram 3- 11 Result 1

4. Press  on the front panel to select AC Voltage measurement function and choose a proper voltage range.
5. Connect the red lead to terminal Input-HI and black lead to terminal Input-LO as Diagram 2-9. By the time, the screen will record the result of measuring AC voltage, as shown in the following diagram.

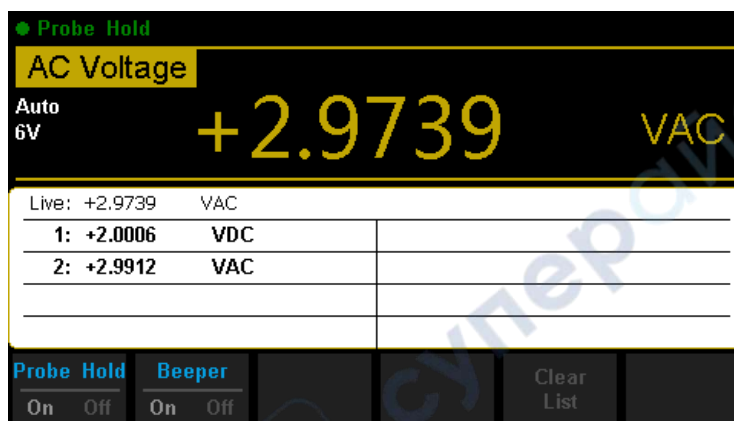

Diagram 3- 12 Result 2

Chapter 4 Measurement Tutorial

True RMS AC Measurement

The AC measurement of the Multimeter has true RMS response. The power dissipated in a resistor within a time is proportional to the square of the measured true RMS voltage, independent of wave shape. The instrument can accurately measure true RMS voltage or current, as long as the wave shape contains negligible energy above the effective bandwidth.

The AC voltage and AC current functions measure the “AC coupled” true RMS value, which is to measure the RMS value of the AC component (DC component is rejected) of the input signal. For sine waves, triangle waves, and square waves, the AC and AC+DC values are equal since these waveforms do not contain a DC offset. See the following table 4-1.

Table 4- 1 True RMS AC Measurement of Sine, Triangle and Square waves

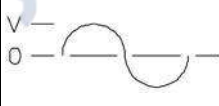
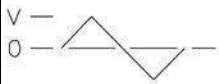
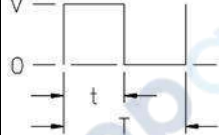
Waveform	Crest Factor (C.F.)	AC RMS	AC+DC RMS
	$\sqrt{2}$	$\frac{V}{\sqrt{2}}$	$\frac{V}{\sqrt{2}}$
	$\sqrt{3}$	$\frac{V}{\sqrt{3}}$	$\frac{V}{\sqrt{3}}$
	$\sqrt{\frac{T}{t}}$	$\frac{V}{C.F.} \times \sqrt{1 - \left(\frac{1}{C.F.}\right)^2}$	$\frac{V}{C.F.}$

Non-symmetrical waveforms, such as pulse trains, contain DC voltages which are rejected by AC coupled true RMS measurements.

An AC coupled true RMS measurement is desirable in situations where you are measuring small AC signals in the presence of DC offsets. For instance, measuring AC ripple present on DC power supplies. There are situations, however, where you might want to know the AC+DC true RMS value. You can determine this value by combining results from DC and AC measurements as the following shows. You should perform the DC measurement using 5.5 digit mode for best AC rejection.

$$RMS_{(AC+DC)} = \sqrt{AC^2 + DC^2}$$

Crest Factor Errors (non-sinusoidal inputs)

A common misconception is that "since an ac Multimeter is true RMS, its sine wave accuracy specifications apply to all waveforms." Actually, the shape of the input signal can dramatically affect measurement accuracy. A common way to describe signal wave shapes is "crest factor". Crest factor is the ratio of the peak value to RMS value of a waveform.

Generally speaking, the greater the crest factor, the greater the energy contained in high frequency harmonics. All Multimeters have errors that are crest factor dependent. (The crest factor errors do not apply for input signals below 100Hz.)

You can estimate the measurement error due to signal crest factor as shown below:

Total Error = Error (Sine wave) + Error (Crest factor) + Error (Bandwidth)

Error (Sine wave): error for sine wave

Error (Crest factor): crest factor additional error

Error (Bandwidth): estimated bandwidth error as shown below:

$$\text{Bandwidth error} = \frac{-C.F. \times F}{4 \pi \times BW} \times 100\% \text{ (\% reading)}$$

C.F.: signal crest factor

F: fundamental frequency of pulse

BW: effective bandwidth of the Multimeter

Example:

Calculate the approximate measurement error for a pulse train input with a crest factor of 2 and a fundamental frequency of 20 kHz. For this example, assume 1-year accuracy specifications of the Multimeter: $\pm (0.05\% \times \text{reading} + 0.03\% \times \text{range})$.

$$\begin{aligned} \text{Total Error} &= (0.05\% \times \text{reading} + 0.03\% \times \text{range}) + (0.05\% \times \text{range}) + \\ &\quad (0.8\% \times \text{reading}) \\ &= 0.85\% \times \text{reading} + 0.08\% \times \text{range} \end{aligned}$$

Loading Errors (AC Voltage)

In the AC Voltage function, the input of SDM3045X appears as a 1M Ω resistance in parallel with 100pF of capacitance. The test lead that you use to connect signals to the Multimeter will also add additional capacitance and loading. The approximate input resistances of the Multimeter at different frequencies are listed in the following table.

Table 4- 2 Approximate Input Resistances at Different Frequencies

Input Frequency	Input Resistance
100Hz	1M Ω
1kHz	850k Ω
10kHz	160k Ω
100kHz	16k Ω

For low frequencies:

$$\text{Error (\%)} = \frac{-R_s}{R_s + 1M\Omega} \times 100\%$$

For high frequencies:

$$\text{Error (\%)} = \left[\frac{1}{\sqrt{1 + (2\pi \times F \times R_s \times C_m)^2}} - 1 \right] \times 100\%$$

F : input frequency

R_s : source resistance

C_m : input capacitance (100pF) plus test lead capacitance

Chapter 5 General Troubleshooting

The following is a list of the troubles that you may meet while using the Multimeter and their solutions. Please handle as the corresponding steps when meeting these troubles. If you still can't handle them, please contact SIGLENT in time.

1. If the screen of the Multimeter is still dark with nothing displaying after pressing the power key:

- (1) Check if the power has been connected correctly.
- (2) Check if the main power switch on the back panel has been turned on already.
- (3) Check if the power fuse has blown. Replace it as desired if it has blown.
- (4) Restart the Multimeter after all above steps have been done.
- (5) If the instrument still can't start up properly, please contact SIGLENT.

2. The reading doesn't change when connecting an AC current signal:

- (1) Check if the test lead has been connected to the current jack or LO jack correctly.
- (2) Check if the fuse in the current location on the back panel has blown.
- (3) Check if the measuring location has switched to the DCI or ACI place correctly.
- (4) Check if the input is ACI but the measuring location is in DCI place.

3. The reading doesn't change when connecting a DC current signal:

- (1) Check if the test lead has been connected to the current jack or LO jack correctly.
- (2) Check if the fuse in the current location on the back panel has blown.
- (3) Check if the measuring location has switched to the DCI or ACI place correctly.
- (4) Check if the input is DCI but the measuring location is in ACI place.

4. USB Disks can't be recognized by the instrument.

- (1) Check if the USB disk can work properly.
- (2) Make sure the used USB disk is of Flash type. The instrument doesn't support USB disks of hard disk type.
- (3) Check if the capacity of the used USB disk is too large. The Multimeter is recommended not to use USB disks which exceed 4GB.
- (4) After restarting the instrument, insert the USB disk again to inspect.
- (5) If you still can't use the USB disk properly, please contact SIGLENT.

Chapter 6 Appendix

Appendix A: Accessories

Standard Accessories:

- A Power Cord that fits the standard of destination country.
- Two test leads (black and red)
- An USB Cable
- A backup fuses
- A Quick Start
- A CD-ROM

NOTE:

- We suggest that the length of USB data wire and LAN cable connected to the instrument should be less than 3m to avoid affecting the product performance.
- All the accessories are available by contacting your local **SIGLENT** office.

Appendix B: Warranty summary

SIGLENT warrants that the products that it manufactures and sells will be free from defects in materials and workmanship for a period of three years from the date of shipment from an authorized **SIGLENT** distributor. If a product proves defective within the respective period, **SIGLENT** will provide repair or replacement as described in the complete warranty statement.

To arrange for service or obtain a copy of the complete warranty statement, please contact your nearest **SIGLENT** sales and service office. Except as provided in this summary or the applicable warranty statement, **SIGLENT** makes no warranty of any kind, express or implied, including without limitation the implied warranties of merchantability and fitness for a particular purpose. In no event shall **SIGLENT** be liable for indirect, special or consequential damages.

Appendix C: Daily Maintenance and Cleaning

Maintenance

When storing or placing the instrument, please avoid the liquid crystal display from direct sunlight for a long time.

NOTE:

To avoid damages to the instrument or probe, please don't place them in mist, liquid or solvent.

Cleaning

Please often clean the instrument or probe according to the use of them.

- Wipe the external ash of the instrument and probe by a soft rag. Be careful not to scratch the transparent plastic protective screen when cleaning the liquid crystal screen.
- Use a soft rag that has been soaked by water to clean the instrument after cutting off the power. Or use 75% isopropyl alcohol of water solvent to get a more thorough cleaning.

NOTE:

- To prevent the surface of the instrument or probe from damages, please don't use any corrosive or chemical cleaning reagents.
- Please make sure the instrument is already dry before restarting it to avoid short circuits or personal injuries caused by water.

Appendix D: Contact SIGLENT

SIGLENT TECHNOLOGIES CO., LTD.

Address: 3F, NO.4 building, Antongda Industrial Zone, 3rd Liuxian
Road, 68th District, Baoan District, Shenzhen, P.R.
China

Tel: +86-755-36615186

Fax: +86-755-3591582

Post Code: 518101