

sanwa®

HG561H

DIGITAL INSULATION RESISTANCE TESTER

INSTRUCTION MANUAL



Table of Contents

[1] SAFETY PRECAUTIONS

*Before use, read the following safety precautions.

- 1-1 Explanation of Warning Symbols 1
- 1-2 Warning Instructions for Safe Use 1
- 1-3 Overload Protection 2





[2] APPLICATIONS AND FEATURES

- 2-1 Applications 3
- 2-2 Features 4

[3] PARTS IDENTIFICATION

- 3-1 Body 5
- 3-2 Measurement Probe, Alligator Clip 6
- 3-3 Display 6

[4] DESCRIPTION OF FUNCTIONS

- 4-1 Changing the Angle of the Measurement Probe ... 7
- 4-2 Power Button  7
- 4-3 Light Button  7
- 4-4 Button Automatic Locking Feature 8
- 4-5 Test Voltage Selection/Hold Button  8
- 4-6 Function Selection Button  8
- 4-7 MΩ test button  (MΩ function) 9
- 4-8 Auto Power Off 9
- 4-9 Low Battery Indication 9

[5] MEASURING PROCEDURE

- 5-1 Pre-operational Check 10
- 5-2 Voltage Measurement 11
- 5-3 Insulation Resistance Measurement 13
- 5-4 Discharge Function 18
- 5-5 Resistance (Ω) Measurement, Continuity Check ... 18

[6] MAINTENANCE

- 6-1 Simple Examination 20
- 6-2 Calibration 20
- 6-3 Battery Replacement 20
- 6-4 Storage 21

[7] AFTER-SALE SERVICE

- 7-1 Warranty and Provision 22
- 7-2 Repair 22
- 7-3 SANWA web site 23

[8] SPECIFICATIONS

- 8-1 General Specifications 24
- 8-2 Measuring Range and Accuracy 25

[1] SAFETY PRECAUTIONS

*Before use, read the following safety precautions.

This instruction manual explains how to use your digital insulation resistance tester HG561H. Before using, read through this manual to reduce the risk of fire, electric shock, and/or injury. And save it together with the product so that you can refer to the manual as necessary.

The instructions given under the headings of "WARNING" must be followed to prevent accidental burn and electric shock and "CAUTION" as well.

1-1 Explanation of Warning Symbols

The meanings of the symbols used in this manual and attached to the product are as follows.

- ⚠ : Extremely-important instructions for safe use
- WARNING identifies conditions and actions that could result in accidental burn and electric shock.
- CAUTION identifies conditions and actions that could cause damage the instrument.

Description of the symbols used in this instrument

- 📖 : Refer to the Instruction Manual before use
- ⎓ : Direct Current (DC) ⏚ : Ground
- ~ : Alternating Current (AC) Ω : Resistance
- ⏻ : POWER button 🔦 : Backlight
- 🔊 : Continuity
- 🛡 : Double Insulation or Reinforced insulation

1-2 Warning Instructions for Safe Use

⚠ WARNING

The following instructions are intended to prevent injury such as burn and electric shock. These instructions must be followed.

1. Do not use the instrument if the body, the measurement probe, the alligator clip, or the earth lead look damaged.
2. Do not apply higher voltage than the max. ratings by each function. (See 1-3)
3. Use caution when working with voltages above 33 V ac rms,

- 46.7 V ac peak, or 70 V dc. These voltages pose a shock hazard.
4. Do not use the instrument to measure lines that may have inductive voltage or surge voltage (e.g. motors) because the input voltage may exceed the maximum rated voltage.
5. Do not use the instrument in places where explosive gas or corrosive gas is generated.
6. Never operate the instrument with the case or battery door removed.
7. Never attempt to repair or modify the instrument, except for battery replacement.
8. Use the specified type of the measurement probe and the alligator clip.
9. Do not hold a test pin side of the barrier of the measurement probe or an alligator clip side of the barrier of the alligator clip lead, while the measurement.
10. Connect the earth lead (the alligator clip) first, then connect the voltage source (the measurement probe). Disconnect the voltage source lead first after the measurement.
11. Make sure the function is properly set while the measurement.
12. Do not switch the function to another function while the measurement.
13. Do not operate the instrument when it is wet or with wet hands.
14. Use the instrument according to the "how to use" described in this instruction manual without exception.
15. Make sure that a pre-operational check is performed and an inspection is performed at least once a year.
16. Do not use the instrument outdoors.
17. Do not use the instrument in an area where explosive gas or corrosive gas is generated.

⚠ CAUTION

Incorrect measurement may be performed in a ferromagnetic or intense electric field near transformers, high-current circuits, or radio equipments, or in a circuit with a large amount of harmonic.

1-3 Overload Protection

Function	Max. Rated Input	Overload Protection
V	600 V dc/ac	660 V dc/ac rms
MΩ	-	660 V dc/ac rms
Ω ^{rel}	⚠ Do not apply any voltage.	600 V dc/ac rms

[2] APPLICATIONS AND FEATURES

2-1 Applications

This instrument is a DC insulation resistance tester designed to measure insulation resistance of electric lines and electric equipments in the range of the CAT. III 300 V and CAT. II 600 V.

- **Measurement categories (overvoltage categories)**
The IEC (International Electrotechnical Commission) standard categorizes measuring circuits for safe use of measuring instruments in low-voltage facilities. The categorization includes II, III, and IV. Higher number of the category corresponds to the place with higher transient energy. For safe measurement, wear insulating gloves, dust-proof glasses and so on in the place of CAT. III.
- **Measurement category IV (CAT. IV)**
Applicable to measurements performed at the source of the low-voltage mains installation.
Applicable to measurements performed in the buildings such as electric measurements on the ripple control units and transient overcurrent protection devices.
- **Measurement category III (CAT. III)**
Applicable to measurements performed at the low-voltage mains installation in the buildings.
Applicable to measurements on distribution boards, circuit-breakers, wiring including cables, bus-bars, junction boxes, switches, socket-outlets in the fixed installation, and equipment for industrial use and some other equipment such as stationary motors with permanent connection to the fixed installation.
- **Measurement category II (CAT. II)**
Applicable to measurements on circuits directly connected to utilization points of the low-voltage mains installation.
Applicable to measurements on household appliances, portable tools, and similar equipment.

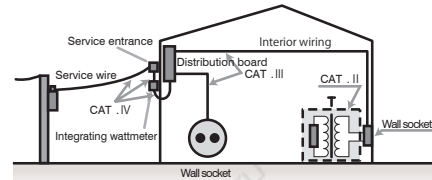

Voltages used in the measurement categories are based on line-to-neutral voltage. The secondary side of 480 V of Three-phase four-wire systems with earthed neutral or Three-phase three-wire systems unearthed is categorized into CAT. III 300 V.

2-2 Features

- Safety design that conforms to the IEC61010/IEC61557
- Though it is pocket size, when measuring MΩ, the rated current is more than 1 mA.
- Provides 7 test voltages (15/25/50/100/125/250/500 V), and any voltage can be selected and fixed. The feature prevents you from mistakenly selecting 500 V.
- Automatically-held readings after measuring MΩ. The LED level meter shows the reading.
- Easy-to-read LCD with the fixed decimal point
- The lighting lamp illuminates a place to be measured, and the LCD has a backlight.
- All-in-one body with the probe enables you to easily watch the tip of the probe and the display at once.
- Provides the probe that enables you to measure through a hole of a circuit breaker cover.
- Auto Power Off feature (approx. 10 min.)
- Auto-discharge feature
- When the probe is applied to the object which is a live-wire (over 30 V) before pressing the test button in the MΩ function, the instrument automatically detects it and displays the voltage, and will not generate any test voltage.

[3] PARTS IDENTIFICATION

3-1 Body

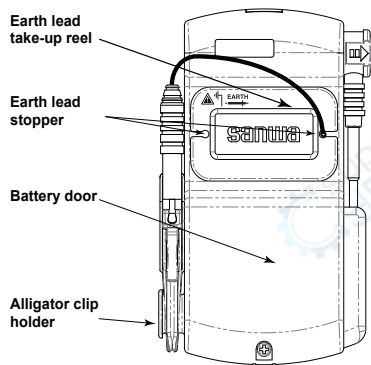
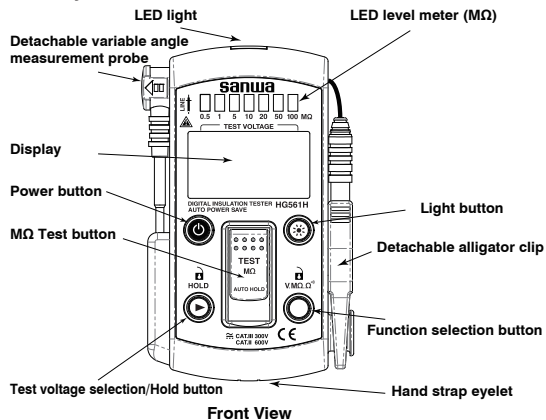

3-2 Measurement Probe, Alligator Clip

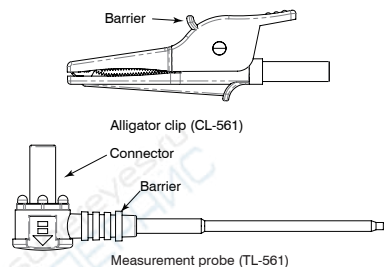

3-3 Display

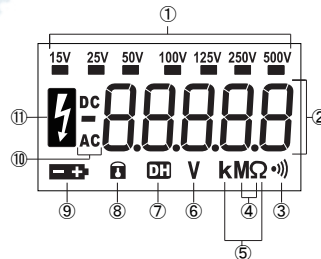

①	Test voltage
②	Numerical display part
③	Continuity beeper
④	Unit of insulation resistance function
⑤	Unit of resistance and continuity function
⑥	Unit of voltage function
⑦	Data Hold indicator
⑧	Button Locking indicator
⑨	Low battery indicator
⑩	Polarity AC/DC/-
⑪	Voltage warning indicator

4] DESCRIPTION OF FUNCTIONS

4-1 Changing the Angle of the Measurement Probe

To change the angle of the measurement probe, pull the probe out from the body and set the angle, then insert the probe again. Make sure that the measurement probe has been properly fitted into the body.

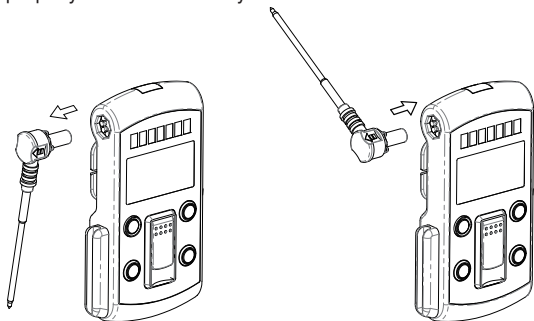

4-2 Power Button

When OFF, pressing the power button for 1 sec. or more turns on the instrument. When ON, pressing the power button for 1 sec. or more turns it off. All segments of the display, LED level meter, LCD backlight, and the LED light will be turned on for approx. 1 sec. after power-on, and then the instrument will be ready to use.

4-3 Light Button

Press the light button to turn on the LCD backlight and the LED light on the top of the body. Press the button again to turn them off.

4-4 Button Automatic Locking Feature

Approx. 15 sec. after the last button operation, the button automatic locking feature will be activated with the beep sound. ( indicator turns on.) While the feature is activated, the following buttons are disabled.

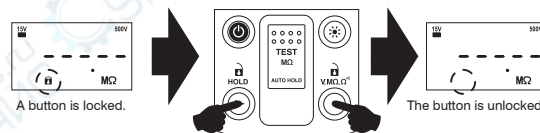

- Insulation resistance measurement function:
Test voltage selection button and Function selection button
- Voltage measurement function and Resistance measurement function:
Function selection button

To release the locked button, press the function selection button and hold for 1 sec. or more. ( indicator turns off.) The locked button cannot be released while the $M\Omega$ button is pressed.



Press the hold button or function selection button and hold it 1 sec. or more.

4-5 Test Voltage Selection/Hold Button

- Test voltage selection ($M\Omega$ function)
Press the button to arbitrarily select a voltage from the voltages indicated on the display.
- Data hold (V or Ω function)
Press the button to freeze present reading for later view. ( indicator turns on.) Input fluctuation will not reflect on the indicated value. Press the data hold button again to disable the data hold feature and go back to the normal measurement mode. ( indicator turns off.)

4-6 Function Selection Button

Press the button to switch the function. Press the button to sequentially switch the function as $V \rightarrow M\Omega \rightarrow \Omega^{(H)} \rightarrow V \rightarrow \dots$.

4-7 M Ω test button (M Ω function)

Press the top of the button to generate a test voltage just while the button is pressed. To make continuous measurement, set the button up.

To stop the measurement, release the button or lay it down again. The last reading on the display and the LED level meter will be held.

The reading will be held until the next measurement and the LED level meter will be turned off approx. 5 sec. later.

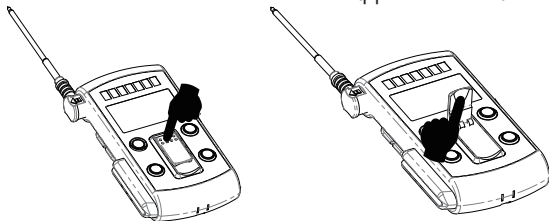

Press the M Ω test button.

Set the M Ω test button up.

Note:

If the M Ω test button is set ON when the power is turned on, $\overline{b} \overline{A} \overline{L} \overline{O} \overline{n}$ will be shown on the display and the beeper sounds. To make the instrument ready to use, release and lay down the test button again.

4-8 Auto Power Off

Approx. 10 min. after the last button operation, the beeper sounds (10 times) and the power will be turned off automatically.

4-9 Low Battery Indication

Decreasing the internal battery voltage to below approx. 4.0 V (4.3 V when 500 V is selected as a test voltage) due to wearing out turns on $\overline{b} \overline{A} \overline{L} \overline{L}$ on the display. Replace all 4 batteries with new ones when the indicator turns on.

Note:

Decreasing the internal battery voltage to a voltage that the instrument does not work due to wearing out indicates $\overline{b} \overline{A} \overline{L} \overline{L}$ on the numeric part of the display.

[5] MEASURING PROCEDURE

⚠ WARNING

1. Do not apply any input signal exceeding the max. rated value for each function.
2. Do not switch the function while measuring.
3. Do not hold the tip side of the barrier of the measurement probe or the tip side of the barrier of the alligator clip while measuring.

5-1 Pre-operational Check

⚠ WARNING

Do not use the instrument if the body, the measurement probe, the alligator clip, or the earth lead look damaged.

⚠ CAUTION

Make sure the low battery indicator is off after power-on. Replace the battery with new ones (all 4 pieces) if the indicator is on.

* In the case nothing is displayed, the batteries may be completely worn out.

Inspection of the display

All segments of the display, LCD backlight and all LEDs will be turned on for approx. 1 sec. after power-on. Check for display defects.

Inspection of disconnection

Set to Ω^{\oplus} function, and make sure the beeper sounds when the measurement probe is connected to the alligator clip.

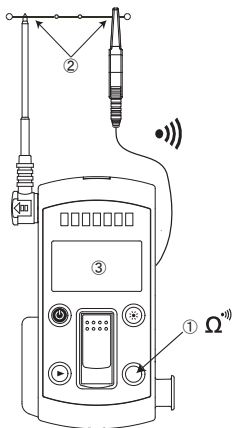

5-2 Voltage Measurement

AC voltage (ACV), DC voltage (DCV) Automatic detection

⚠ WARNING

Do not apply any input signal exceeding the max. rated input voltage.

1) What to measure

ACV: Sine wave voltages such as output from a wall socket, output from a low-frequency amplifier, and etc.

DCV: Batteries, DC circuit voltages, and etc.

2) Measuring ranges

Function	Measuring range	Accuracy	Remarks
ACV	600.0 V	±(1.6 %rdg + 7 dgt)	Over 600 V: Beeps
DCV	600.0 V		Over 610 V: "OL" displayed

3) Measuring procedure

- ① Set the V function.
- ② Connect the alligator clip to the circuit to be measured and the measurement probe too.
- ③ Read the display.

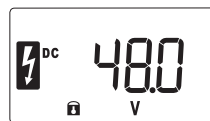
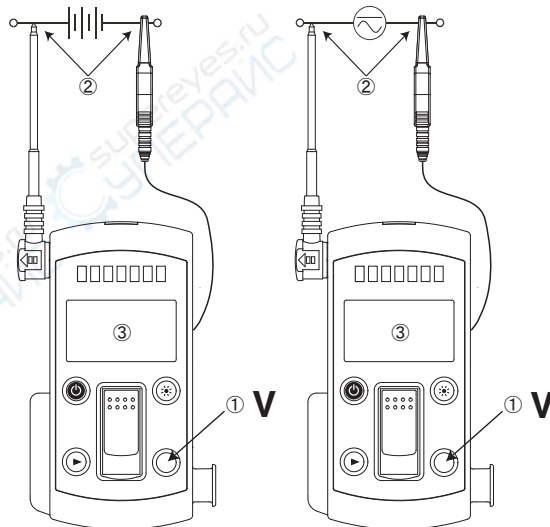

Note:

ACV or DCV will be automatically selected.

Voltage exceeding 30 V ac/dc turns on  on the display and makes periodic beep.

5-3 Insulation Resistance Measurement

⚠ WARNING

1. Do not apply any voltage to the measuring terminals.
2. Disconnect the power supply from the circuit to be measured and make sure any voltage does not remain on it, then make the measurement.
3. Do not touch the circuit to be measured while measuring as the instrument generates high voltage for the measurement.
4. Pay attention not to get shocked as the instrument and the circuit to be measured are charged with high voltage.
5. Discharge the high voltage charged to the circuit to be measured to prevent the risk of electric shock. (See the section 5-4.)

⚠ CAUTION

1. High voltage is generated on the measuring terminals. It is recommended that you make the insulation resistance measurement with any low or unknown withstanding voltage equipments or parts (semiconductors, etc.) disconnected from the circuit for breakage prevention. Pay special attention to computer-related equipments.
2. Make a measurement with a test voltage that is close to the working voltage of the circuit to be measured.
3. It may take longer time to measure insulation resistance when the circuit to be measured has a capacitance component.
4. Generally, connect the alligator clip to the earth side (Ground) and the measurement probe to the circuit side (LINE) when the circuit to be measured is grounded. (This connection way shows generally lower value than the other connection.)
5. The earth lead connected to the LINE side should not touch the circuit to be measured or the earth in order to prevent measurement error.
6. Insulation resistance changes a lot depending on temperature and humidity. Also it changes depending on the applied voltage (Test voltage). Generally higher temperature, higher humidity, or higher test voltage shows lower insulation resistance.
7. Oscillation noise during the measurement is not due to failure.

Test voltage selection mode

The instrument makes only necessary voltages enabled between 15 V, 25 V, 50 V, 100 V, 125 V, 250 V, and 500 V. Only the selected test voltages can be used after the setting. For instance, after you make 50 V, 125 V, and 250 V enabled, only those 3 voltages can be used. (The indication 15V, 25V, 100V, and 500V will be turned off.) To re-select test voltages you need, enable the voltages in the test voltage selection mode again.

How to select a test voltage

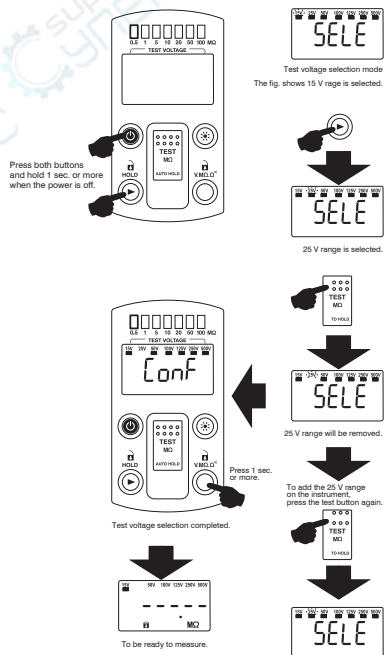

Note:

If the power is turned off during the test voltage selection mode, the selected voltages before the time will not be reflected. The selection completes after $\square \square n F$ is indicated on the display.

The selected test voltages are memorized into the instrument, and only the selected voltages can be used when the power is turned on again after being turned off.

1) What to measure

MΩ: Insulation resistance of low-voltage electric equipment and equipment items.

2) Measuring ranges (Automatic range selection)

Test voltage	Measuring range	Accuracy	Remarks
15 V 25 V 50 V	9.99 MΩ 21.0 MΩ	± (2 %rdg + 5 dgt)	Over 21.1 MΩ: "OL" displayed
100 V 125 V 250 V 500 V	9.99 MΩ 99.9 MΩ 110. MΩ		Over 111 MΩ: "OL" displayed

3) Measuring procedure

- ① Set the MΩ function.
- ② Set a test voltage.
- ③ Connect the alligator clip to the circuit to be measured and the measurement probe too.
- ④ Press the test button.
- ⑤ Read the display or the LED level meter.

Note:

Make sure the test voltages you need are enabled. If the voltages are not shown on the display, make the voltages enabled in the test voltage selection mode again. The instrument displays up to 3 digits with fixed decimal point.



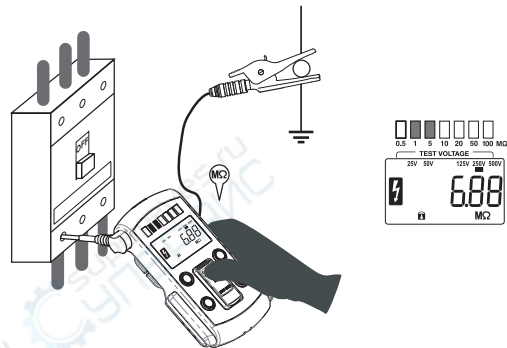



Example of insulation resistance measurement

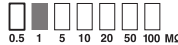

How to read the LED level meter when the test voltage is 100 V, 125 V, 250 V, or 500 V.

Reading	LED level meter
0.49 MΩ or under	0.5 1 5 10 20 50 100 MΩ
0.50 MΩ ~ 0.99 MΩ	0.5 1 5 10 20 50 100 MΩ
1.00 MΩ ~ 4.99 MΩ	0.5 1 5 10 20 50 100 MΩ
5.00 MΩ ~ 9.99 MΩ	0.5 1 5 10 20 50 100 MΩ
10.0 MΩ ~ 19.9 MΩ	0.5 1 5 10 20 50 100 MΩ
20.0 MΩ ~ 49.9 MΩ	0.5 1 5 10 20 50 100 MΩ
50.0 MΩ ~ 99.9 MΩ	0.5 1 5 10 20 50 100 MΩ
100. MΩ ~ 110. MΩ	0.5 1 5 10 20 50 100 MΩ
111. MΩ or over	0.5 1 5 10 20 50 100 MΩ

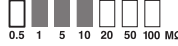
How to read the LED level meter when the test voltage is 15 V, 25 V, or 50 V.

Reading	LED level meter
0.49 M Ω or under	
0.50 M Ω ~ 0.99 M Ω	
1.00 M Ω ~ 4.99 M Ω	
5.00 M Ω ~ 9.99 M Ω	
10.0 M Ω ~ 19.9 M Ω	
20.0 M Ω or over	

When the circuit to be measured is in a hot line condition (≥ 30 V ac/dc), the voltage and  will be indicated on the display and the beep sounds. Under the condition, even if the M Ω test button gets pressed, the instrument will not generate any test voltage. Turn off the circuit to be measured, and then measure again.

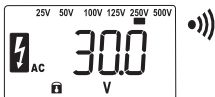

- The LED level meter works synchronizing with the reading on the display. (* Refer to "How to read the LED level meter".)
- A voltage between 5 Vac and 30 Vac (Ghost voltage etc.) on the circuit to be measured makes the "AC" on the display blink. Unstable reading may be shown during the insulation resistance measurement under the condition.

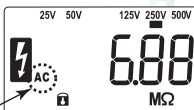

A ghost voltage makes "AC" blink and the reading may be unstable.



After the measurement, the instrument holds the last reading on the display, and starts the automatic discharge. When a voltage of the circuit to be measured decreases to 30 V or lower,  on the display will be turned off. (Refer to "5-4 Discharge Function".)

* Insulation resistance measurement principle:

Detecting a current flowing through the circuit to be measured being applied a DC voltage, the insulation resistance is calculated from "the voltage / the current".

5-4 Discharge Function

Measuring a capacitive circuit to be measured will charge it with a rated test voltage. This function discharges the remaining high voltage from the circuit to be measured to prevent from electric shock.

1. Keep the measurement probe and the alligator clip connected to the circuit to be measured, and turn off the M Ω measurement switch after the M Ω measurement finished.
2. The instrument automatically starts the discharge.  on the display means "still under discharging". When the discharge finishes or a voltage of the circuit to be measured gets to 30 V or less,  gets turned off.

5-5 Resistance (Ω) Measurement, Continuity Check



Do not apply any voltage to the measuring terminals.

1) What to measure

Resistance: Resistor, circuit resistance, etc.

Continuity check: Wiring connections, Operation of switches, etc.

2) Measuring ranges

Function	Measuring range	Accuracy	Remarks
Resistance measurement	999.9 Ω	$\pm(1.5\%rdg + 7\text{ dgt})$	$\leq 30\ \Omega$: Beeps
Continuity	99.99 k Ω		9.999 k Ω :
Check	999.9 k Ω		Not supported Over 1 M Ω : "OL"

- ① Set Ω function. (Ω or k Ω will be indicated.)
- ② Connect the alligator clip to the circuit to be measured and the measurement probe too.
- ③ Read the display.

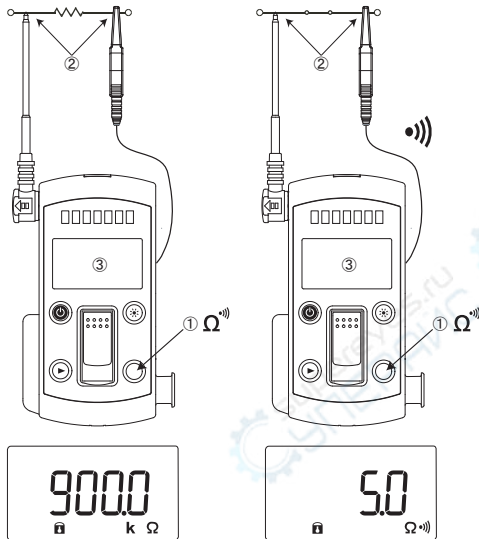

Note:

- M Ω measurement button is not available.
- Open circuit voltage between the input terminals:
Approx. 2.0 ~ 2.5 Vdc

[6] MAINTENANCE

⚠ WARNING

1. The followings are important to safety. Read this manual thoroughly to maintain the instrument.
2. Calibrate and inspect the instrument at least once a year to ensure safety and maintain its accuracy.

6-1 Simple Examination

1) Appearance:

- Check that the instrument does not look damaged caused by dropping etc.
- #### 2) Measurement Probe, Alligator Clip, Earth lead:
- Check that the measurement probe and the alligator clip fit on the instrument.
 - Check for the earth lead especially exposed core wire anywhere on it.

If you find any problem on the above items, stop using immediately and ask us to repair it.

6-2 Calibration

For requesting calibration and inspection, contact an authorized agent/distribution service provider, listed in our website. (See 7-2 section 4)

6-3 Battery Replacement

⚠ WARNING

1. Do not open the battery door with live input terminals to avoid electric shock.
2. Make sure the power is OFF, before starting the replacement.

Pre-installed battery

Since the pre-installed battery is for monitoring, it may not be durable as typically expected.

*The purpose of the battery for monitoring is to check for the functions and performances of the product.

Replacement procedure

- ① Remove the screw fixing the battery door using a slotted screwdriver.
- ② Remove the battery door and replace all the 4 batteries with new ones according to the battery mark inside the battery holder.
- ③ Re-fasten the battery door screw. That is all.

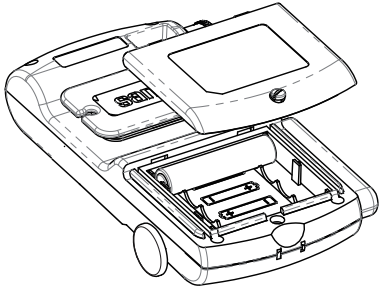

6-4 Storage

⚠ CAUTION

1. The body is not resistant to volatile solvents. Do not wipe out with solvents or isopropyl alcohol. Clean the instrument up with a dry soft cloth.
2. The body is not resistant to heat. Keep it away from heat-generating devices such as solder irons.
3. Do not save the instrument into vibratory places or where the instrument may fall off.
4. Do not expose the instrument to direct sunlight and do not save it into any places with extreme temperature, humid, or condensation.
5. Remove the battery for saving the instrument over a long period of time.

Save the instrument into an appropriate place, according to the precautions above. (Refer to the section 8-1.)

[7] AFTER-SALE SERVICE

7-1 Warranty and Provision

Sanwa offers comprehensive warranty services to its end-users and to its product resellers. Under Sanwa's general warranty policy, each instrument is warranted to be free from defects in workmanship or material under normal use for the period of one

(1) year from the date of purchase.

This warranty policy is valid within the country of purchase only, and applied only to the product purchased from Sanwa authorized agent or distributor.

Sanwa reserves the right to inspect all warranty claims to determine the extent to which the warranty policy shall apply. This warranty shall not apply to disposables batteries, or any product or parts, which have been subject to one of the following causes:

1. A failure due to improper handling or use that deviates from the instruction manual.
2. A failure due to inadequate repair or modification by people other than Sanwa service personnel.
3. A failure due to causes not attributable to this product such as fire, flood and other natural disaster.
4. Non-operation due to a discharged battery.
5. A failure or damage due to transportation, relocation or dropping after the purchase.

7-2 Repair

Customers are asked to provide the following information when requesting services:

1. Customer name, address, and contact information
2. Description of problem
3. Description of product configuration
4. Model Number
5. Product Serial Number
6. Proof of Date-of-Purchase
7. Where you purchased the product

Please contact Sanwa authorized agent / distributor / service provider, listed in our website, in your country with above information. An instrument sent to Sanwa / agent

/ distributor without above information will be returned to the customer.

Note:

1) Prior to requesting repair, please check the following:

Capacity of the built-in battery, polarity of installation and discontinuity of the test leads.

2) Repair during the warranty period:

The failed meter will be repaired in accordance with the conditions stipulated in 7-1 Warranty and Provision.

3) Repair after the warranty period has expired:

In some cases, repair and transportation cost may become higher than the price of the product. Please contact Sanwa authorized agent / service provider in advance.

The minimum retention period of service functional parts is 6 years after the discontinuation of manufacture. This retention period is the repair warranty period. Please note, however, if such functional parts become unavailable for reasons of discontinuation of manufacture, etc., the retention period may become shorter accordingly.

4) Precautions when sending the product to be repaired:

To ensure the safety of the product during transportation, place the product in a box that is larger than the product 5 times or more in volume and fill cushion materials fully and then clearly mark "Repair Product Enclosed" on the box surface. The cost of sending and returning the product shall be borne by the customer.

7-3 SANWA web site

<http://www.sanwa-meter.co.jp>

E-mail: exp_sales@sanwa-meter.co.jp

[8] SPECIFICATIONS

8-1 General Specifications

Operation method	Delta-sigma modulation
AC sensing method	Average detection
LCD	9.99/99.9/110 (MΩ), 610.0 (Voltage), 9999 (Resistance)
Sampling rate	Approx. 2 times / sec.
Over-range indication	"OL" on the numerical part and beep The LED level meter blinks.
Range selection	Automatic selection
Polarity switching	Automatic switching ("-" will be indicated as necessary.)
Low battery indication	Lower than approx. 4.0 V ~ 4.3 V (depending on the function);  indicated
Operating conditions	Altitude: ≤ 2,000 m, Pollution degree: II, Indoor use only
Operating temperature/humidity	0 °C to 40 °C : 90 %RH (Max.) non-condensing
Storage temperature/humidity	-10 °C to 50 °C : 90 %RH (Max.) non-condensing (with battery removed)
Power source	Alkaline battery 1.5 V (LR03) 4 pieces
Auto Power Off	Power-off approx. 10 min. after the last operation.
Max. Power consumption	Approx. 2.5 VA (when 500 V, 0.5 MΩ measurement)
Possible measurement times	1,000 times (when 500 V, 0.5 MΩ, ON: 5 sec./ OFF: 25 sec.)
Dimension, Mass	#139 x #91 x D29 Approx. 230 g (with batteries)
Manufacturing year	Most significant 2 digits of the serial number on the back of the instrument show the lower 2 digits of the manufacturing year (20xx).
IP Protection rating	IP30 (with measurement probe)
Safety Compliances	IEC61010-1 CAT.III 300 V, II 600 V IEC61010-2-030, IEC61010-2-033 IEC61557-1 and 2, IEC61010-031
EMC, RoHS	IEC61326-1(EMC), EN50581 (RoHS)
Accessories	Instruction manual, Measurement probe (TL-561), Alligator clip (CL-561), Carrying case (C-DG3a)

(The instrument usually accepts Ni-MH rechargeable batteries, and may not work without the low battery indication caused by the discharge characteristic of the batteries. We recommend you have spare batteries with you just in case.)

8-2 Measuring Range and Accuracy

Accuracy: $\pm(\% \text{ rdg} + \text{dgt})$

rdg: reading dgt: least significant digit

Temperature: $23 \pm 5 \text{ }^\circ\text{C}$

Humidity: < 75 % R.H. without condensation

External magnetic field: negligible small

Battery voltage: within the battery effective range

Voltage: ACV, DCV

Function	Range	Accuracy	Remarks
ACV	600.0 V	$\pm(1.6 \% \text{rdg} + 7 \text{dgt})$	Input resistance: Approx. 10 M Ω
DCV	600.0 V		Input resistance: Approx. 10 M Ω

AC/DC automatically selectable

Accuracy-guaranteed frequency range: 40 to 400 Hz Sine wave AC

Insulation resistance M Ω

Test voltage	Range	Median value	Effective measuring range	Accuracy	Remarks
15 V	9.99 M Ω 21.0 M Ω	1.0 M Ω	0.00 ~ 21.0 M Ω	$\pm(2 \% \text{rdg} + 5 \text{dgt})$	Over 21.1 M Ω : "OL" displayed
25 V					
50 V					
100 V	9.99 M Ω 99.9 M Ω 110. M Ω	10.0 M Ω	0.00 ~ 110. M Ω		Over 111 M Ω : "OL" displayed
125 V					
250 V					
500 V					

- Rated current: 1 mA (1 mA ~ 1.2 mA)
- Acceptable range of open circuit voltage: Rated output voltage X 1 ~ 1.25
- Lowest resistance to maintain the rated output voltage: Rated output voltage X 0.001 M Ω Ex.) 0.25 M Ω when 250 V

"test voltage=rated output voltage" means a rated voltage of the output voltage. The output voltage can go down depending on the load, if the load resistance is lower than the lowest resistance described above.

Ex. When measuring 0.1 M Ω with a test voltage 500 V, the actual output voltage will be 100 V (= 1 mA X 0.1 M Ω).

Resistance, Continuity Ω^{all}

Range	Accuracy
999.9 Ω 99.99 k Ω 999.9 k Ω	$\pm(1.5 \% \text{rdg} + 7 \text{dgt})$

- Open circuit voltage: Approx. 2.0 to 2.5 Vdc
- $\leq 30.0 \Omega$: Beep sounds.

IEC61557 compatible

Measurement	Uncertainty	Operating instrumental uncertainty
Voltage	$\pm(1.6 \text{rdg}\% + 7 \text{dgt})$	$\pm 30 \%$
Insulation resistance	$\pm(2 \% \text{rdg} + 5 \text{dgt})$	$\pm 30 \%$

This specification describes maximum values accepted by the standard.

* variation due to changing

"E1: Position, E2: supply voltage, E3: Temperature"

How to calculate accuracy

Ex.) AC voltage measurement (ACV)

Reading: 100.0 V

Range accuracy: $\pm(1.6 \% \text{rdg} + 7 \text{dgt})$ in the 600 V range

Measuring error: $\pm(100.0 \text{ V} \times 1.6 \% + 7 \text{dgt}) = \pm 2.3 \text{ V}$

True value: $100.0 \text{ V} \pm 2.3 \text{ V}$ (from 97.7 V to 102.3 V)

* 3 dgt in the 600 V range corresponds to 0.3 V.

The product specifications and its appearance described in this manual are subject to change without prior notice for improvement or other reasons.

sanwa®

三和電気計器株式会社

本社=東京都千代田区外神田2-4-4・電波ビル

郵便番号=101-0021・電話=東京(03)3253-4871(代)

大阪営業所=大阪市浪速区恵美須西2-7-2

郵便番号=556-0003・電話=大阪(06)6631-7361(代)

SANWA ELECTRIC INSTRUMENT CO.,LTD.

Dempa Bldg., 4-4 Sotokanda2-Chome Chiyoda-Ku,Tokyo,Japan



This manual employs soy ink.

04-1704 5008 6009