

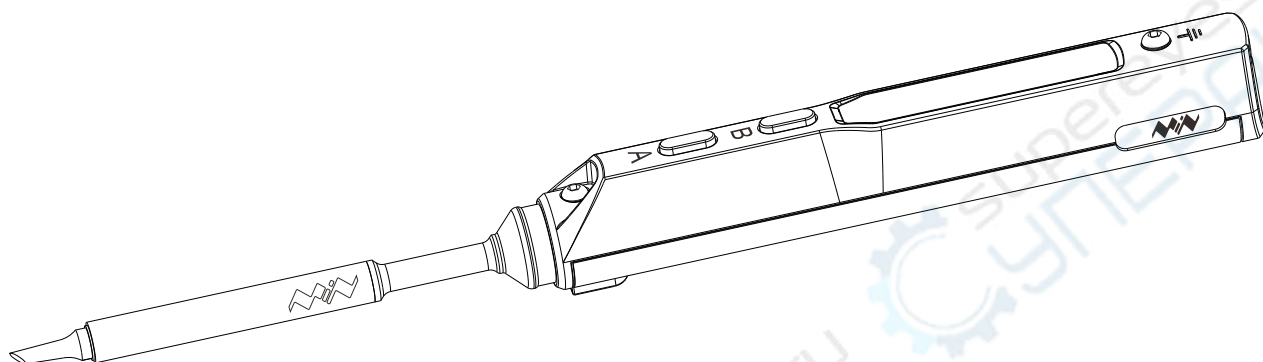

MINIWARE



TS100 Mini Soldering Iron

Instruction Manual

Version 1.0.3

Please read this manual before operating
the TS100(this instruction
manual is based on APPV2.18

Content



WARNING: Failure to comply a WARNING may result in serious injury to the user or others.



CAUTION: Failure to comply a CAUTION may cause damage to the product or other equipments.



NOTE: Annotations, operation notes or additional information.



1 Safety Statement

P1



2 Overview

P3



3 Power Adaptor Selection

P5



4 Operation

P6



5 Soldering Iron Tip

P14



6 Trouble Shooting Guide

P16



7 Technical Support

P18



8 Legal Statements

P20

1.1 General Safety



- Use only certified power source/adaptors from your region. (please refer to 3.0 for specifications)
- Do not operate in humid environment.
- Do not operate in inflammable/explosive environment.
- Keep the surface of the product clean and dry.

1.2 Working condition

Working condition	Requirements
Temperature	Operating Condition: from 0°C to +50°C
	Non-operating Condition: from -20°C to +60°C
Humidity	Operating Condition: from 40°C to 50 °C, 0% to 60% RH
	Operating Condition: from 0°C to 40 °C, 10% to 90% RH
	Non-operating Condition: from 40°C to 60°C, 5% to 60%RH
	Non-operating Condition: Low temperature: from 0°C to 40°C, 5% to 90%RH

1.3 Warnings



When using TS100,
Turn the power off when not in use, or left unattended.
When power is ON, tip temperatures will be between
100°C~400°C(212°F~752°F), please be careful.
Please don't operate TS100 when it's wet or operate
it with wet hands, which will cause an electric shock.

1.4 Cautions



When using TS100,

- The handle is constructed with precision, dropping shall be avoided.
- After continuous use up to 40 minutes, the handle surface temperature will reach 50°C~60°C.
- For the first time using, TS100 may generate a light smoke due to the heating of heating elements, which is a normal phenomenon.

1.5 Liability Statement

Any damage of the product, or losses related to the product damage, if it's man-caused, or assumed to be man-caused, the liability will belong to the user.

2.1 Ports and Control Panel Introduction

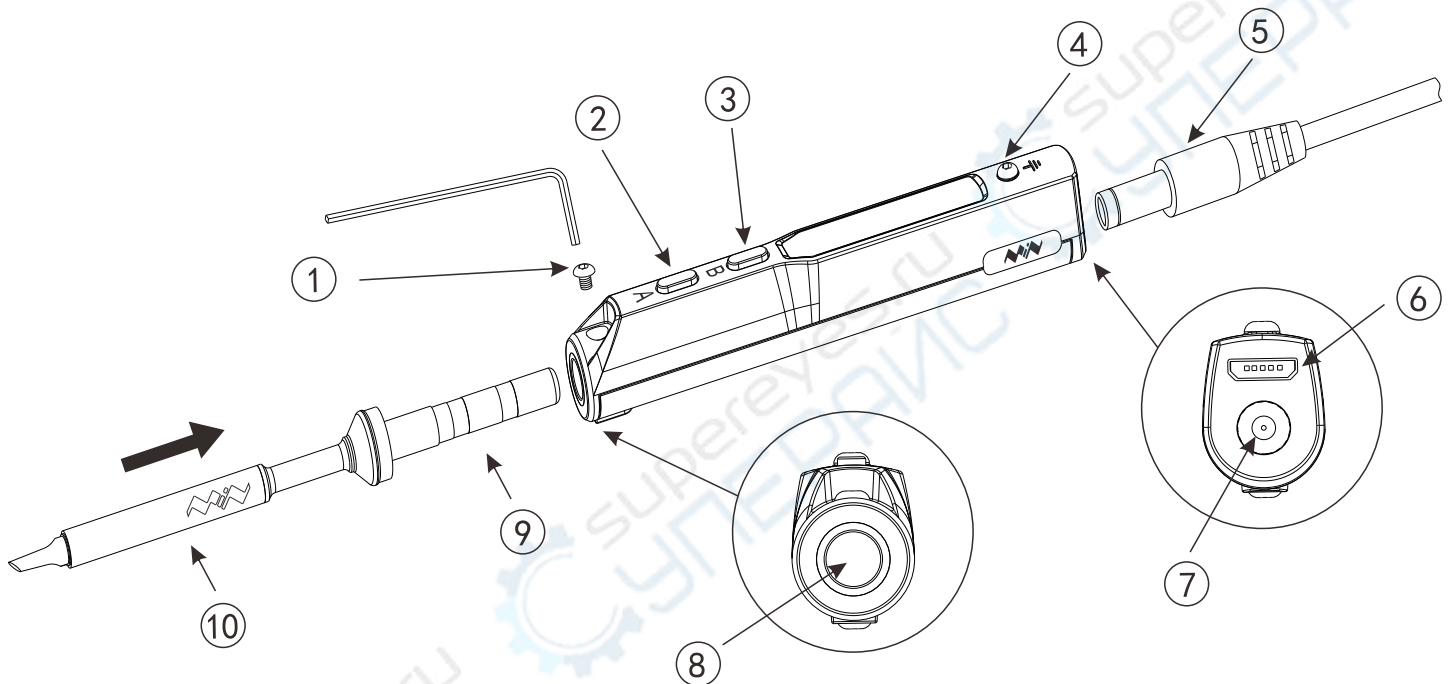

1. The tip setscrew
2. Button A
3. Button B
4. Ground cable fixing screw
5. Power connector
6. Micro USB
7. DC5525 12-24V port
8. Soldering tip port
9. Soldering tip connector
10. Soldering tip heating end

2.2 Specifications



Screen	OLED
USB port	Micro USB
Power port	DC5525
Dimensions	Operation unit Length:96mm, Diameter:16.5mm
	Heating unit Length:72+33mm, Diameter:5.5mm
Weight	33g(power adaptor not included)

2.3 Operation Specifications



Power	65W
Temperature range	100°C~400°C (max)
Temperature stability	±2%
Operation temperature under heat	40°C
Soldering tip resistance to the ground	<2 Ω

Before connecting Dc5525 (12-24V) power adaptor, check if the adaptor is in good condition as below standard.

We would recommend the (19V,2.1A) power supply as an accessory for TS100.

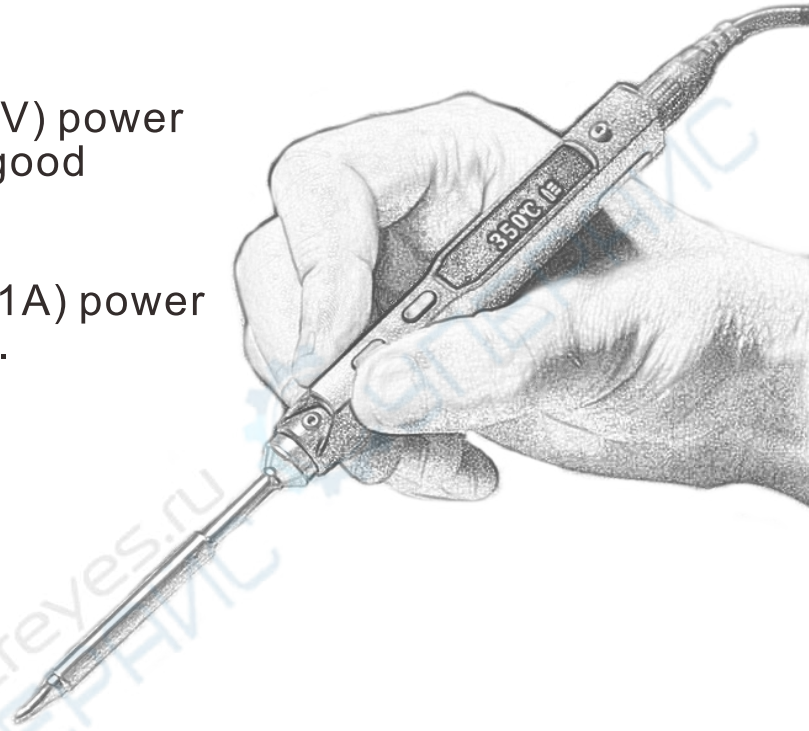

Operation voltage	Power	Electric current	Time required to increased tip temperature from 30°C to 300°C
12V	17W	> 1.4A	40s
16V	30W	> 1.9A	20s
19V	40W	> 2.1A	15s
24V	65W	> 2.7A	11s

4.1 TS100 Installation

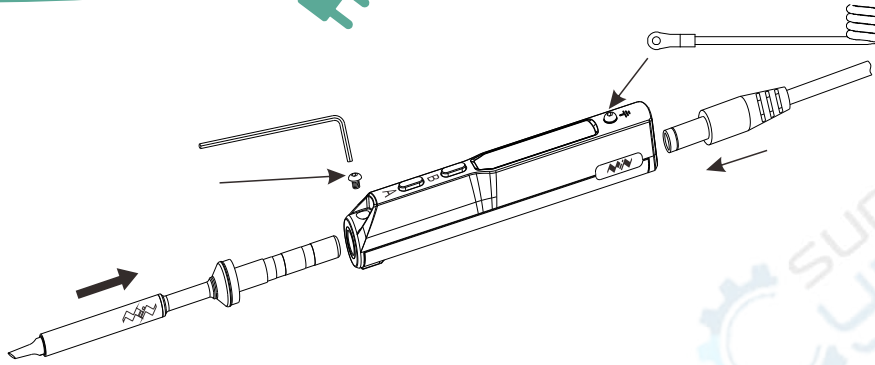

1. Loosen the tip setscrew, insert the soldering tip connector and tighten the screw;
2. Connect the ground wire to the ground wire setscrew ;
3. Connect the DC connector to TS100, connect the power cord and turn on the power accordingly.



Note: If the screen displays "sen-err" when it's plugged, means the soldering iron tip is not properly fixed, please re-install it properly.

4.2 Default Settings

Default temperature unit	°C
Default temperature	300°C (Default)
Sleep mode temperature	200°C (Default)
Adjustable temperature range	100°C~400°C (Max)

4.3 Basic Control

4.3.1 Screen Display

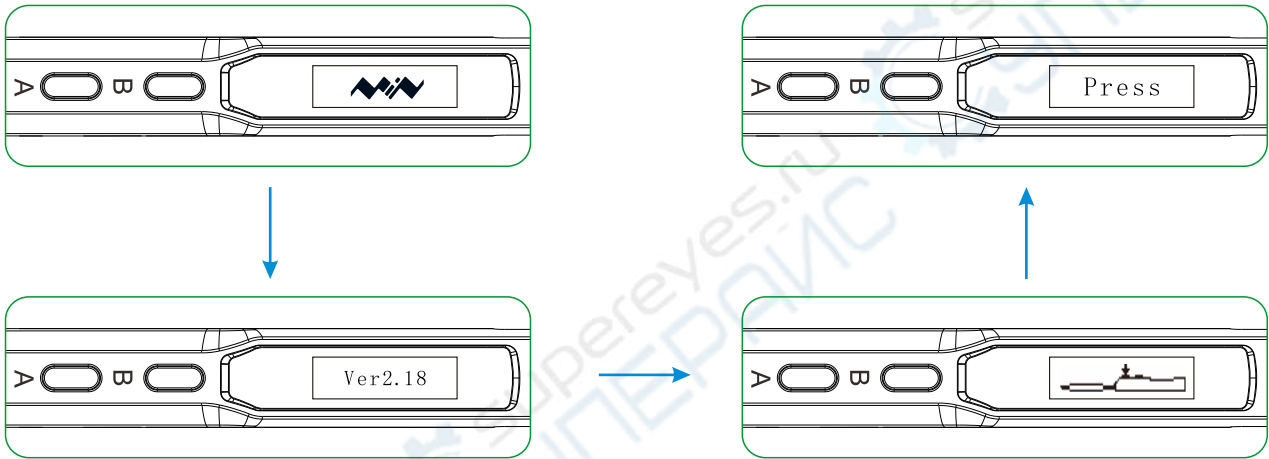

When plugged into DC12-24V power adaptor ,TS100 will display its logo, Version number and its standby screen in sequence.

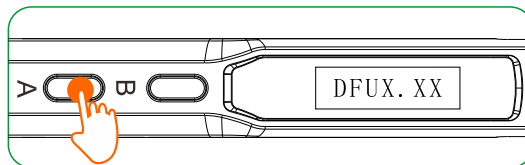

When plugging into DC 12-24V power adapaort ,pressing Button A at the sametime will enter DFU mode,"DFUX.XX" will appear on OLED screen . To exit DFU mode: unplug and plug in the device again without pressing any button , then it will enter standby mode.

4.3 Basic Control

4.3.2 Heating up

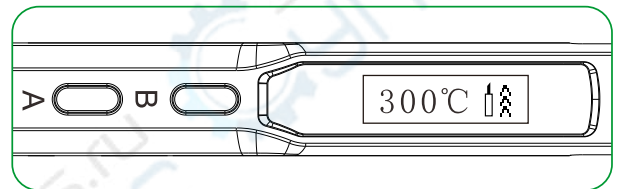
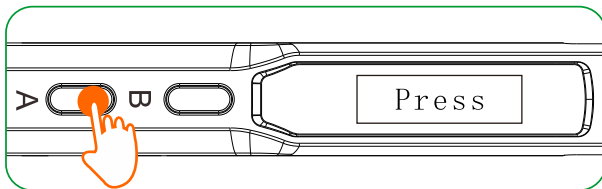

When pressing Button A in standby mode, TS100 will heat up to preset temperature.

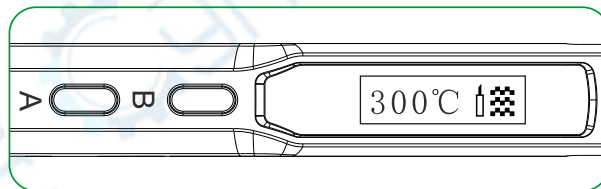

When OLED displays as picture, means it's ready for soldering.

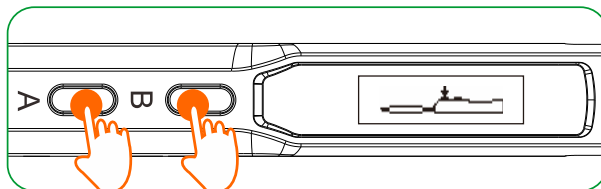

In operation mode, holding both buttons for 3 seconds will return to standby mode.

4.3 Basic Control

4.3.3 Temperature Adjustment

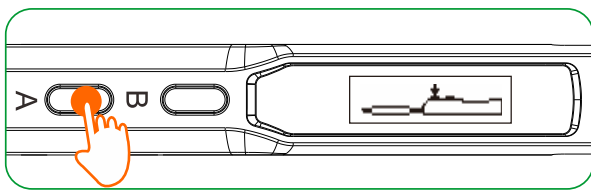

In standby mode, press Button A to start heating, TS100 will enter preset temperature.

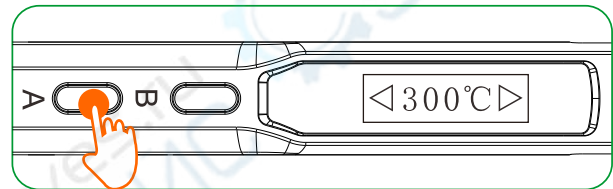

Temperature down: In temperature adjusting mode, hold Button A for at least 2 seconds, press Button A to decrease temperature.

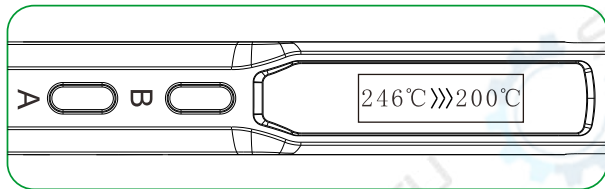

Release Button A when display reads the expected temperature, and TS100 will automatically adjust to it.

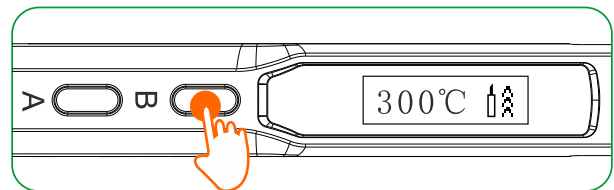

Temperature up: In temperature adjusting mode, hold Button B for at least 2 seconds, press Button B to increase temperature.

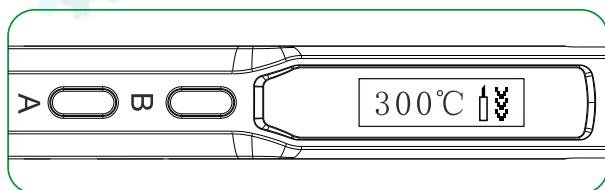

Release Button B when display reads the expected temperature, and TS100 will automatically adjust to it.

Tips: Hold Button A/B to fast adjust temperature.

4.3 Basic Control

4.3.4 parameter settings

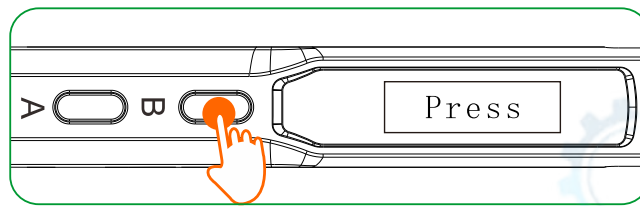

Short press Button “B” in standby mode to enter setting mode;
Short press Button “A/B” in setting mode to select the setting menu and long press Button “A/B” to enter modification; after entering modification, press Button “A/B” to select the appropriate set value; and wait for 5s to return to setting mode. Change the other settings in the same way.

 **Note:** the functions of button A and B are interchangeable in left-hand mode (LH).

Menu Interpretation

Parameter Image	Parameter Name	Definition	Factory Defaults	Adjustable Range
19.92V 25°C		Current input voltage, current soldering iron tip temperature.		Not adjustable
Factory Reset		Restore factory defaults.		
WkTemp 300	Working Temperature	Working temperature.	300°C	100-400°C
SlpTime 180	Sleep Time	The time needed to enter sleep mode from working mode.	180	60-999 Seconds
StbTemp 200	Sleep Temperature	Standby temperature when entering sleep mode.	200°C	100-400°C
IdlTime 360	Standby time	When standing still, the time from sleep mode to standby mode.	360	100-999 Seconds
TempStp 10	Temperature Stepping	When standing still, the time from sleep mode to standby mode.	10	1-25

Parameter Image	Parameter Name	Definition	Factory Defaults	Adjustable Range
OffVolt 10.0	Protection Voltage	Protection voltage when working, the voltage is lower than the set value, the soldering iron will stop working.	10.0V	5.0-12.0V
Temp CT	Temperature Display Unit	Temperature display unit, in celsius degree(°C) or Fahrenheit degree (F).	°C	°C/°F
Hand RT	Left/right hand mode	Left/right hand use mode, screen display directions are reverse and key functions are interchangeable in different modes.	RT	RH(right hand)/ LH(left hand)

4.3 Basic Control

4.3.5 Automatic calibration

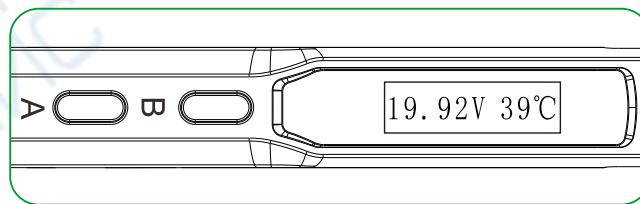

In the "current input voltage" menu of the setting mode, long press Button A or Button B to enter the automatic calibration.

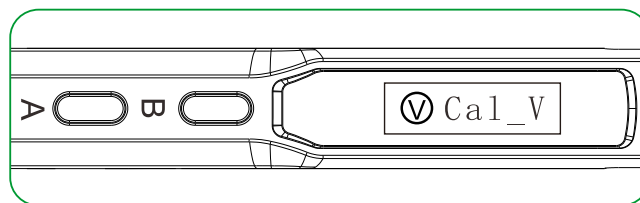

Note: Please insert the soldering tip into the TS100 controller before entering automatic calibration, and let it stand for 10 minutes. Make sure Ts100 and the soldering tip have dropped to room temperature, and then connect the power supply to calibrate.

4.3 Basic Control

4.3.6 Temperature Adjustment

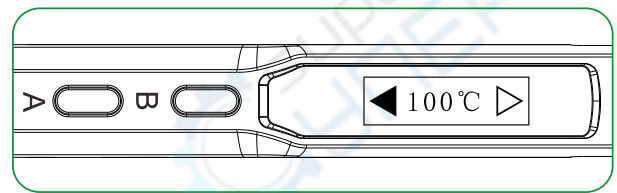
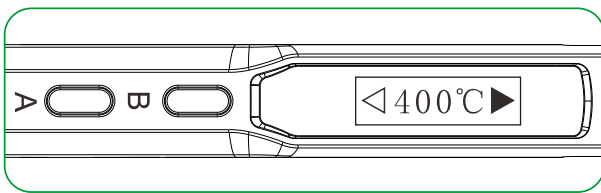

Note: When screen displays arrow pointing to left or right (◀ or ▶) which means the adjustment has already reached its upper/lower limit temperature, settings will not be saved when power is off

Remark: Maximum temperature: 400°C
Minimum temperature: 100°C

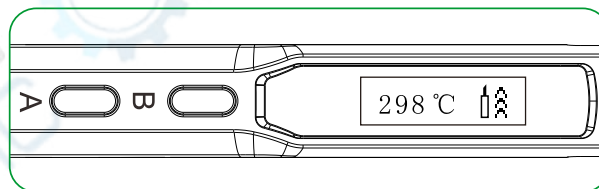

When TS100 temperature stabilizes for 60 seconds, it will automatically enter feedback mode.

The last icon on the right end of the display shown as below



Arrows up-heating



arrows down-cooling



horizontal lines- temperature stabilized

4.3 Basic Control

4.3.7 Sleep Mode

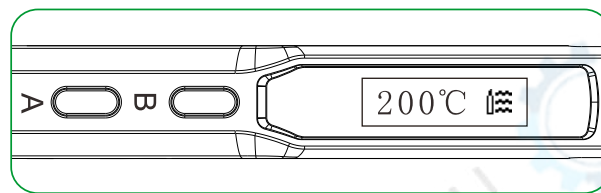

In operation mode, when leaving TS100 for more than 180 seconds (⌚ 3 minutes in Default) will trigger the sleep mode, and temperature will automatically adjust to preset sleep temperature.

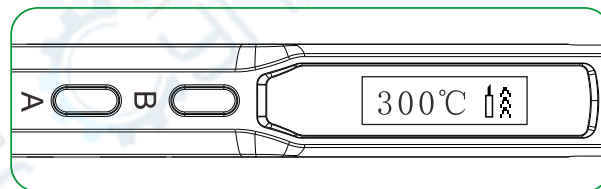

When moved, TS100 will restart to operation mode and temperature will automatically heat up to preset temperature (300°C in Default).

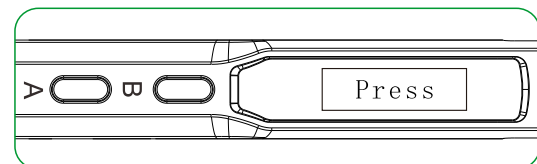
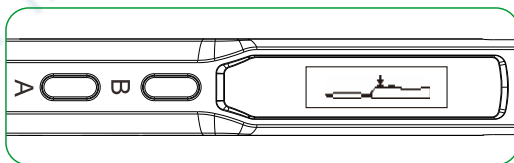

In sleep mode, if it's not being operated for longer than the IDLE_TIME setting, TS100 will then enter the standby mode.

Note: IDLE_TIME can be adjusted (⌚ 6 minutes in Default). (Preset minimum IDLE time: 100 seconds)

4.4 System Parameters

Parameter	Explanation	Default	Adjustable range
StbTemp	Standby mode temperature	200°C	100°C~400°C
WkTemp	Operating temperature	300°C	100°C~400°C
SlpTime	Time from operation mode to sleep mode	180 seconds	60~999 seconds
IdlTime	Time from sleep mode to standby mode	360 seconds	100~999 seconds
TempStp	When preset "1", each step will progress in 1,2,5,25; when preset 2-25, each step will progress according to settings	10	1-25
OffVolt	When operation voltage is lower than default voltage TS100 will return to stadby mode	10V	5-12V
Temp	Temperature unit selection	°C	0 is °C, 1 is °F
Hand	Left/right hand mode	RT	RT(right hand)/LT(left hand)
ZeroP_Ad	Temperature calibration parameter, TS100 automatic adjustment		No manual setting required



Notice: Preset parameter(s) will be updated to TS100 after saved.

5.1 Changing Soldering Tips

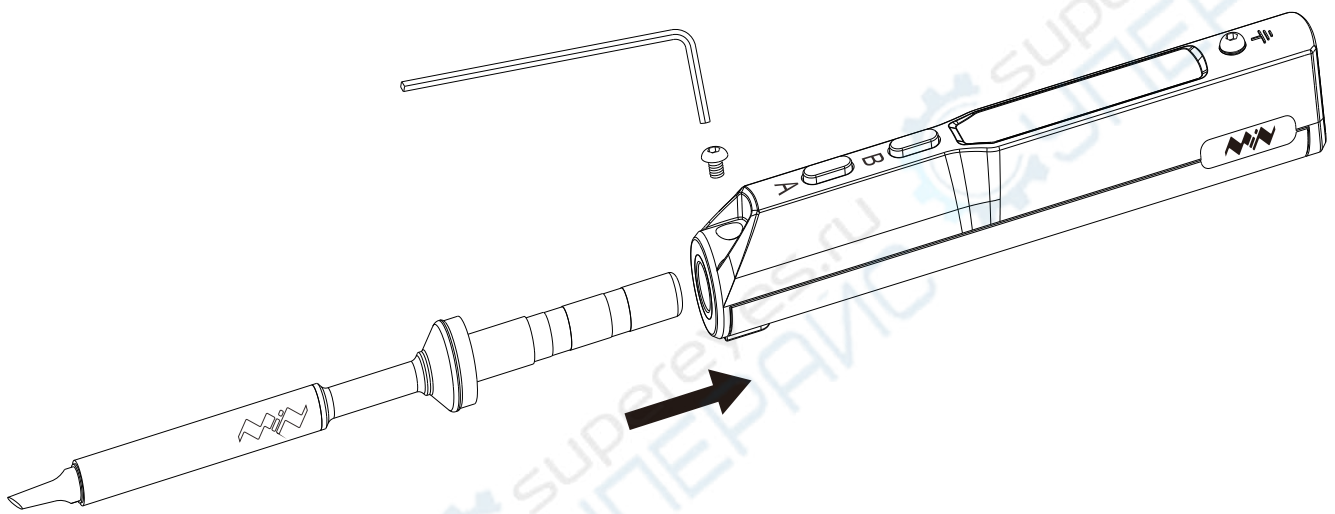

1. Unplug TS100 before changing.
2. Loosen the tip setscrew.
3. Pull out the tip, replace with another one.
4. Tighten the screw.

Note: When TS100 displays "sen-err", it means the soldering tip is not installed properly. Please unplug and install again.

5.2 Choosing Soldering Iron Tips

Note: Choosing the right tips will help you to work more efficient

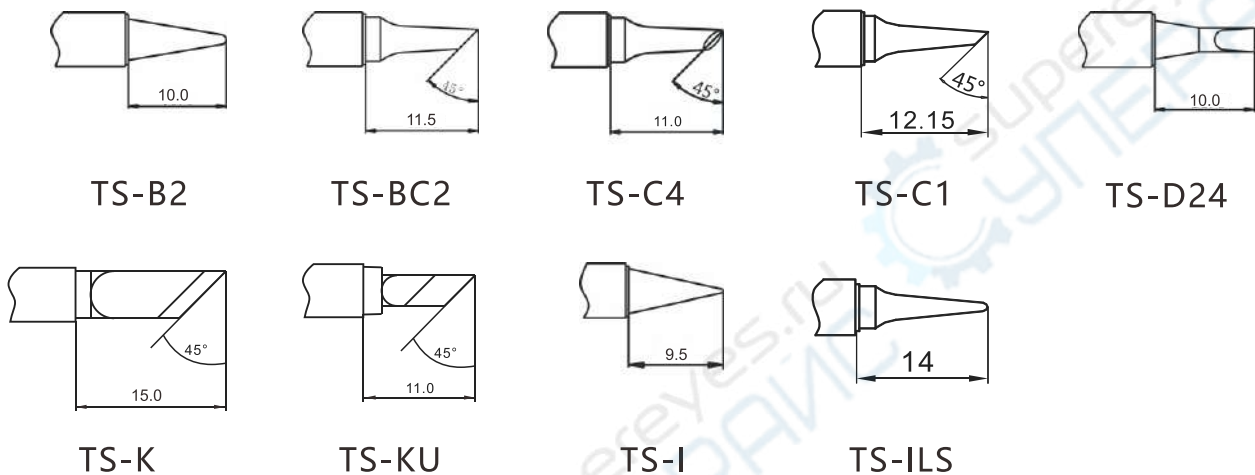

5.3 Soldering Iron Tip Maintenance

- (1) Before switching off, wipe the tip's soldering side with some solder.
- (2) Do not leave the tip in high temperature for long time, which may cause it burnt out.
- (3) Do not push too hard while soldering, which will damage the tip.
- (4) Do not use rough material or files to clean the tip.
- (5) If the tip surface is oxidized and makes it hard to apply solder on it, you may use 600~800 grit sandpaper to wipe the tip with Ethanol or Isopropyl alcohol, heat up to 200°C and apply solder immediately to avoid it oxidize again.
- (6) Do not use Flux that contains high chlorine or acid, use only resin based flux.

5.4 Soldering Iron Tip Lifespan

Soldering iron tip's lifespan is related to its maintenance (refer to 5.3) and use intensity.

6

Trouble Shooting Guide

Problem 1:No Display

Check:If the cable is broken
Check:Is there any data in USB mode
Check:If the screen needs to be replaced

Problem 2:Every time when installing a new tip, the temperature status display random numbers

Means the machine is checking status,which is normal

Problem 3:Soldering iron restart automatically

Check 1:Is it properly plugged into the power source?
Check 2:Is the voltage too low?
(need to be set up in the config file)

Problem 4:Soldering iron is heating up and cooling down simultaneously

Check 1:Is the tip first time in use?
Check 2:Is the power cord in loose or defective contact?
Check 3:Is the tip overheating?
Set the temperature in appropriate level
Check 4:Is the soldering iron clean?
refer to "Soldering iron tip maintenance"

Problem 5:OLED shows "Warning!"

Check 1:Is the TS100 overheating?
Is TS100 temperature higher than the maximum operation temperature
When temperature is lower than maximum operation temperature, the warning sign will disappear and it will return to operation mode

Problem 6: OLED displays "High-Vt"

Check: Is the voltage too high? (over 24V)

Problem 7: OLED displays "Sen-err"

Check 1: Is the soldering iron installed properly?
Check 2: If check 1 passes, then replace the soldering iron tip

Problem 8: The tip doesn't stick to the solder

1. Tip temperature is over 400°C
 2. The soldering side of the tip is not applied with solder properly
 3. Lack of flux during operation
 4. Rub the tip against dry or high sulfur sponge or fabric
 5. Tip touched organic material like plastic, silicone oil or other chemicals
 6. Using impure solder or solder that contains low proportion of tin
-

Problem 9: TS100 return to standby mode during operation

Check: Is the voltage lower than default (10V)
Wait until voltage recovers, it could work normally when the voltage is over 10V

7.1 Standard service

1 year of warranty will be provided for TS100 controller, if the damage was not caused by false manipulation by the user. Please contact your retailer for warranty detail. Tips are consumables, once it's used, no replacement will be provided.

7.2 Default Parameter Setting

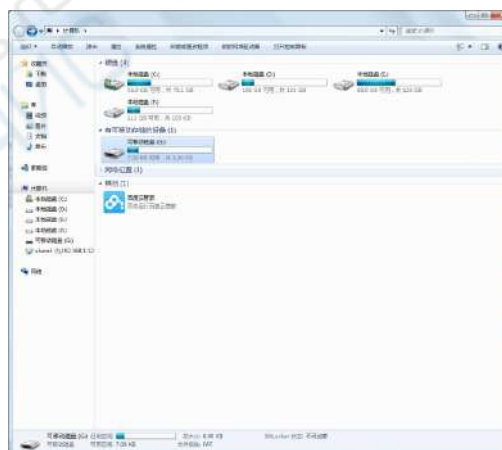

```

CONFIG - 记事本
文件(F) 编辑(E) 格式(O) 查看(V) 帮助(H)
StbTemp=200    #(100~400)
WkTemp=300    #(100~400)
SlpTime=180   #(60~999)
IdleTime=360  #(100~999)
TempStp=10    #(1~25)
OffVolt=10    #(5~19)
Temp=0        #(0,1)
Hand=0        #(0,1)
ZeroP_Ad=253  #ReadOnly
  
```

Connect TS100 to your PC with USB data cord, OLED will display "CONFIG" and means it's in setting mode. Open config.txt file from the USB drive, set the default parameters.

7.3 Firmware Update



1. Visit www.miniware.com.cn and download the latest TS100 firmware to your PC.
2. Connect TS100 to your PC with USB data cord, meanwhile, press TS100's Button A to enter DFU mode once it shows "DFU X.XX" on the screen. A virtual disk with 8 serial numbers will appear on your PC.
3. Copy the hex firmware to the root directory of that disk. When the extension of the firmware changes from "hex" to "rdy", disconnect USB and the firmware is upgraded.

7.4 Changing Boot Up Screen

Create your own 96*16 pixel image save as BMP in single color bitmap

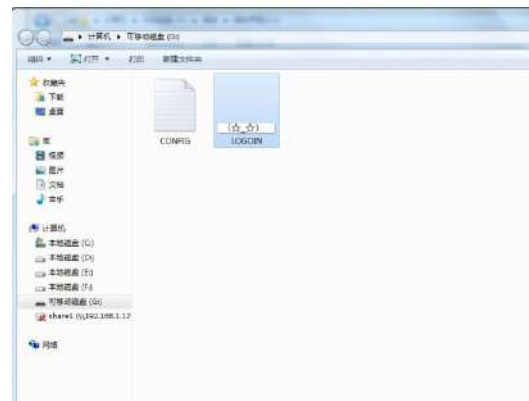

Copy the file to soldering iron's USB drive, change file name to "LOGOIN"

Note: When the "LOGOIN.BMP" exists in the USB drive, the boot up logo will be using the file, if the file doesn't exist, it will be using the default logo instead

8.1 Disposal



Do not dispose this product with domestic waste.

Handling and recycle: Disposal of the product shall be manipulated according to laws and regulations in your area.

8.2 Statement of Fulfilling FCC Standard



This device fulfills part 15 of the FCC regulations. Device must fulfill below 2 conditions:

- (1) Device must not generate interference.
- (2) Device must be able to resist any interferences on it, including interferences that could cause dangerous manipulation.

8.3 Statement of Fulfilling CE Standard



This is a trademark of Europe Union. This product with CE logo on it fulfills related Euro Union laws and regulations.