



**XDS3000 Dual-Channel Series
Digital Storage Oscilloscopes
User Manual**

Oct 2023 edition V1.6.4

Copyright © LILLIPUT Company. All rights reserved.

The LILLIPUT's products are under the protection of the patent rights, including ones which have already obtained the patent rights and those which are applied for. The information in this manual will replace all materials published.

The information in this manual was correct at the time of printing. However, LILLIPUT will continue to improve products and reserves the rights to change specification at any time without notice.

owon[®] is the registered trademark of the LILLIPUT Company.

Fujian LILLIPUT Optoelectronics Technology Co., Ltd.

No. 19, Heming Road

Lantian Industrial Zone, Zhangzhou 363005 P.R. China

General Warranty

We warrant that the product will be free from defects in materials and workmanship for a period of 3 years from the date of purchase of the product by the original purchaser from our company. The warranty period for accessories such as probes, battery is 12 months. This warranty only applies to the original purchaser and is not transferable to a third party.

If the product proves defective during the warranty period, we will either repair the defective product without charge for parts and labour, or will provide a replacement in exchange for the defective product. Parts, modules and replacement products used by our company for warranty work may be new or reconditioned like new. All replaced parts, modules and products become the property of our company.

In order to obtain service under this warranty, the customer must notify our company of the defect before the expiration of the warranty period. Customer shall be responsible for packaging and shipping the defective product to the designated service centre, a copy of the customers proof of purchase is also required.

This warranty shall not apply to any defect, failure or damage caused by improper use or improper or inadequate maintenance and care. We shall not be obligated to furnish service under this warranty a) to repair damage resulting from attempts by personnel other than our company representatives to install, repair or service the product; b) to repair damage resulting from improper use or connection to incompatible equipment; c) to repair any damage or malfunction caused by the use of not our supplies; or d) to service a product that has been modified or integrated with other products when the effect of such modification or integration increases the time or difficulty of servicing the product.

Please contact the nearest Sales and Service Offices for services.

Excepting the after-sales services provided in this summary or the applicable warranty statements, we will not offer any guarantee for maintenance definitely declared or hinted, including but not limited to the implied guarantee for marketability and special-purpose acceptability. We should not take any responsibilities for any indirect, special or consequent damages.

Table of Contents

1. General Safety Requirements	1
2. Safety Terms and Symbols	2
3. Junior User Guidebook	4
Introduction to the Structure of the Oscilloscope	5
Front Panel.....	5
Front Panel Menu Buttons.....	6
Rear Panel.....	6
Control Area.....	7
User Interface Introduction	8
How to Implement the General Inspection	10
How to Implement the Function Inspection	11
How to Implement the Probe Compensation	12
How to Set the Probe Attenuation Coefficient	12
How to Use the Probe Safely	13
How to Implement Self-calibration	14
Introduction to the Vertical System	14
Introduction to the Horizontal System	15
Introduction to the Trigger System	16
Touchscreen Controls (Touchscreen is optional)	17
Operate the Menu through Touchscreen.....	17
Gestures in Normal Mode.....	17
Gestures in Wave Zoom Mode.....	21
Other Operations Using Touchscreen.....	23
Magnifier Function (Only for XDS3102AP/XDS3202A with touchscreen)	23
4. Advanced User Guidebook	26
How to Set the Vertical System	27
Use Mathematical Manipulation Function	29
Waveform math.....	31
User defined function.....	31
Digital Filter.....	32
Using FFT function.....	32
Use Vertical Position and Scale Knobs	38
How to Set the Horizontal System	38
Zoom the Waveform.....	39
How to Set the Trigger/Decoding System	39
Single Trigger.....	40
Alternate Trigger (Trigger mode: Edge).....	50

Bus Trigger	50
Bus Decoding (Optional)	56
How to Operate the Function Menu	60
How to Implement Sampling Setup	60
How to Set the Display System	62
How to Save and Recall a Waveform	65
How to Record/Playback Waveforms	72
How to Clone and Recall a waveform	75
How to Implement the Auxiliary System Function Setting	80
How to Update your Instrument Firmware	83
How to Measure Automatically	85
Customize an Automatic Measurement	90
How to Measure with Cursors	90
How to Use Autoscale	94
How to Use Built-in Help	95
How to Use Executive Buttons	96
How to Print the Screen Image	97
5. Use the Arbitrary Function Generator (Optional)	99
Output Connection	99
To Set Channels	99
To Set Signals	100
To Output Sine Signals	100
To Set the Frequency	100
To Set the Period	101
To Set the Start Phase	101
To Set the Amplitude	101
To Set the Offset	102
To Set the High Level	102
To Set the Low Level	102
To Output Square Signals	102
To Output Ramp Signals	102
To Set the Symmetry of Ramp	102
To Output Pulse Signals	102
To Set the Pulse Width of Pulse	102
To Set the Duty Cycle of Pulse	102
To Output Arbitrary Signals	102
Create a New Waveform	103
File Browse	104
Built-in Waveform	104
Frequency Response Analysis	106
6. Use the Multimeter (Optional)	108
Input Terminals	108
DMM Menu	108

DMM Information Window	109
Making Multimeter Measurements	110
Measuring AC or DC Current	110
Measuring AC or DC Voltage	110
Measuring Resistance	111
Testing Diodes	111
Testing for Continuity	111
Measuring Capacitance	111
Multimeter Features	112
Data Hold Mode	112
Making Relative Measurements	112
Information Display	112
Auto or Manual Range	112
Multimeter Recorder	112
7. Communication with PC	115
Using USB Port	115
Using LAN Port	116
Connect directly	116
Connect through a router	117
Using Wi-Fi to Connect with PC (Optional)	119
Connect with PC as Wi-Fi Access Point	119
Connect with PC as Wi-Fi Station	120
8. Communication with Android Device via Wi-Fi (Optional)	123
How to Connect	123
Connect with APP as Wi-Fi Access Point	123
Connect with APP as Wi-Fi Station	125
User Interface	127
Gestures Control	129
9. Demonstration	131
Example 1: Measurement a Simple Signal	131
Example 2: Gain of a Amplifier in a Metering Circuit	132
Example 3: Capturing a Single Signal	133
Example 4: Analyze the Details of a Signal	134
Example 5: Application of X-Y Function	136
Example 6: Video Signal Trigger	137
10. Troubleshooting	139
11. Technical Specifications	140
Oscilloscope	140
Trigger	145
Waveform Generator (Optional)	146

Multimeter (Optional)	147
General Technical Specifications	148
12. Appendix	149
Appendix A: Enclosure	149
Appendix B: General Care and Cleaning	149
Appendix C: Battery Using Guide	150

1. General Safety Requirements

Before use, please read the following safety precautions to avoid any possible bodily injury and to prevent this product or any other connected products from damage. In order to avoid any contingent danger, ensure this product is only used within the range specified.

Only the qualified technicians can implement the maintenance.

To avoid Fire or Personal Injury:

- **Connect the probe correctly.** The grounding end of the probe corresponds to the grounding phase. Please don't connect the grounding end to the positive phase.
- **Use Proper Power Cord.** Use only the power cord supplied with the product and certified to use in your country.
- **Connect or Disconnect Correctly.** When the probe or test lead is connected to a voltage source, please do not connect and disconnect the probe or test lead at random.
- **Product Grounded.** This instrument is grounded through the power cord grounding conductor. To avoid electric shock, the grounding conductor must be grounded. The product must be grounded properly before any connection with its input or output terminal.

When powered by AC power, it is not allowed to measure AC power source directly, because the testing ground and power cord ground conductor are connected together, otherwise, it will cause short circuit.

When powered by battery, the product must ground connection. To avoid electric shock, there must be a ground wire connect between ground and the ground port (on the back of product panel).

- **Check all Terminal Ratings.** To avoid fire or shock hazard, check all ratings and markers of this product. Refer to the user's manual for more information about ratings before connecting to the instrument.
- **Do not operate without covers.** Do not operate the instrument with covers or panels removed.
- **Use Proper Fuse.** Use only the specified type and rating fuse for this instrument.
- **Avoid exposed circuit.** Do not touch exposed junctions and components when the instrument is powered.
- **Do not operate if in any doubt.** If you suspect damage occurs to the instrument, have it inspected by qualified service personnel before further operations.
- **Use your Oscilloscope in a well-ventilated area.** Make sure the instrument installed with proper ventilation, refer to the user manual for more details.
- **Do not operate in wet conditions.**
- **Do not operate in an explosive atmosphere.**
- **Keep product surfaces clean and dry.**

2. Safety Terms and Symbols

Safety Terms

Terms in this manual. The following terms may appear in this manual:



Warning: Warning indicates the conditions or practices that could result in injury or loss of life.



Caution: Caution indicates the conditions or practices that could result in damage to this product or other property.

Terms on the product. The following terms may appear on this product:

Danger: It indicates an injury or hazard may immediately happen.

Warning: It indicates an injury or hazard may be accessible potentially.

Caution: It indicates a potential damage to the instrument or other property might occur.

Safety Symbols

Symbols on the product. The following symbol may appear on the product:



Hazardous Voltage



Refer to Manual



Protective Earth Terminal



Chassis Ground



Test Ground

To avoid body damage and prevent product and connected equipment damage, carefully read the following safety information before using the test tool. This product can only be used in the specified applications.



Warning:

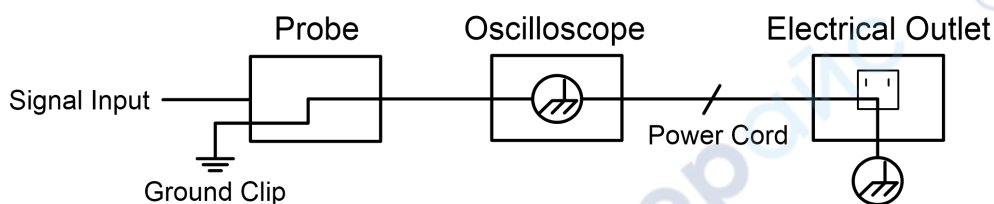
The two channels of the oscilloscope are not electrically isolated. The channels should adopt a common ground during measuring. To prevent short circuits, the 2 probe grounds must not be connected to 2 different non-isolated DC levels.



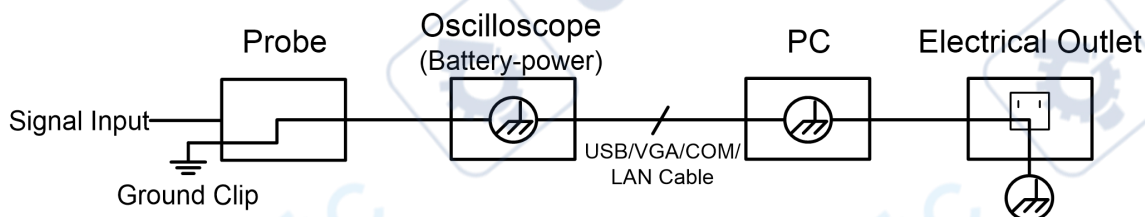
Warning:

Note when measuring the channel to the public base, otherwise may cause short circuit because of the oscilloscope probe ground wire.

The diagram of the oscilloscope ground wire connection:



The diagram of the ground wire connection when the battery-powered oscilloscope is connected to the AC-powered PC through the ports:



It is not allowed to measure AC power when the oscilloscope is AC powered, or when the battery-powered oscilloscope is connected to the AC-powered PC through the ports.



Warning:

To avoid fire or electrical shock, when the oscilloscope input signal connected is more than 42V peak (30Vrms) or on circuits of more than 4800VA, please take note of below items:

- Only use accessory insulated voltage probes and test lead.
- Check the accessories such as probe before use and replace it if there are any damages.
- Remove probes, test leads and other accessories immediately after use.
- Remove USB cable which connects oscilloscope and computer.
- Do not apply input voltages above the rating of the instrument because the probe tip voltage will directly transmit to the oscilloscope. Use with caution when the probe is set as 1:1.
- Do not use exposed metal BNC or banana plug connectors.
- Do not insert metal objects into connectors.

3. Junior User Guidebook

This chapter deals with the following topics mainly:

- Introduction to the structure of the oscilloscope
- Introduction to the user interface
- How to implement the general inspection
- How to implement the function inspection
- How to make a probe compensation
- How to set the probe attenuation coefficient
- How to use the probe safely
- How to implement an auto-calibration
- Introduction to the vertical system
- Introduction to the horizontal system
- Introduction to the trigger system
- Touchscreen Controls (Touchscreen is optional)

Introduction to the Structure of the Oscilloscope

This chapter makes a simple description of the operation and function of the front panel of the oscilloscope, enabling you to be familiar with the use of the oscilloscope in the shortest time.

Front Panel

The front panel has knobs and function buttons. The 5 buttons in the column on the right side of the display screen or in the row under the display screen are menu selection buttons, through which, you can set the different options for the current menu. The other buttons are function buttons, through which, you can enter different function menus or obtain a specific function application directly.

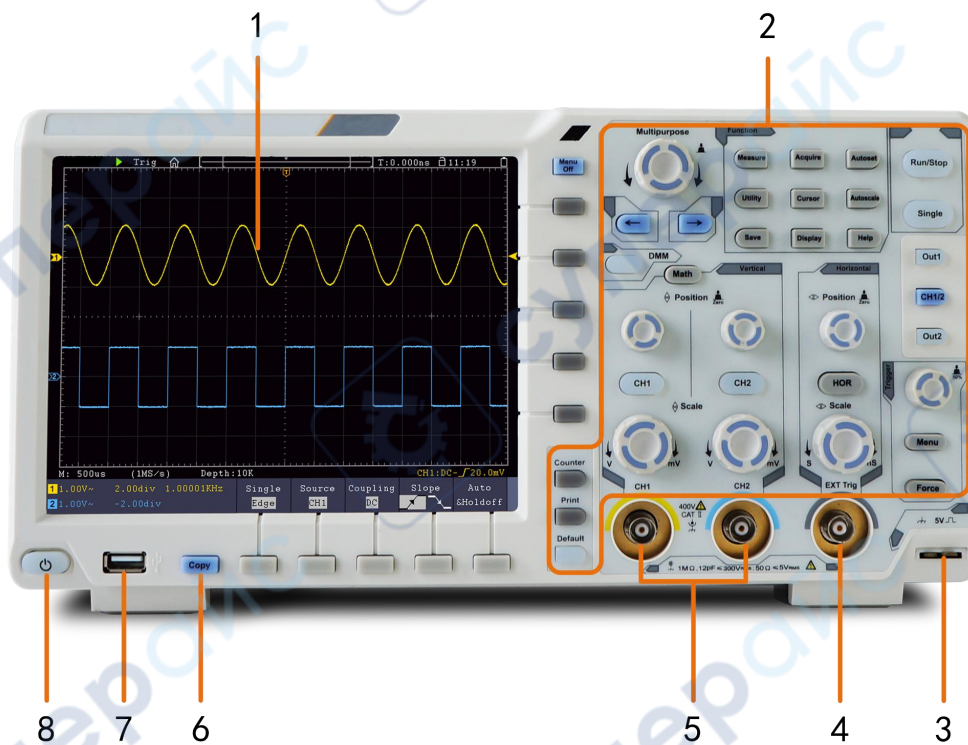


Figure 3- 1 Front panel

1. Display area.
2. Control (button and knob) area.
3. Probe Compensation: Measurement signal (5V/1kHz) output.
4. EXT Trigger Input.
5. Signal Input Channel.
6. Copy button: You can save the waveform by just pressing this button in any user interface.
7. **USB Host port:** It is used to transfer data when external USB equipment connects to the oscilloscope regarded as "host device". For example: Saving the waveform to USB flash disk needs to use this port.
8. Power on/off

Backlight of this button:

Red light: The oscilloscope is turned off (connects with AC Power or battery);

Green light: The oscilloscope is turned on (powered by AC Power or battery).

Front Panel Menu Buttons

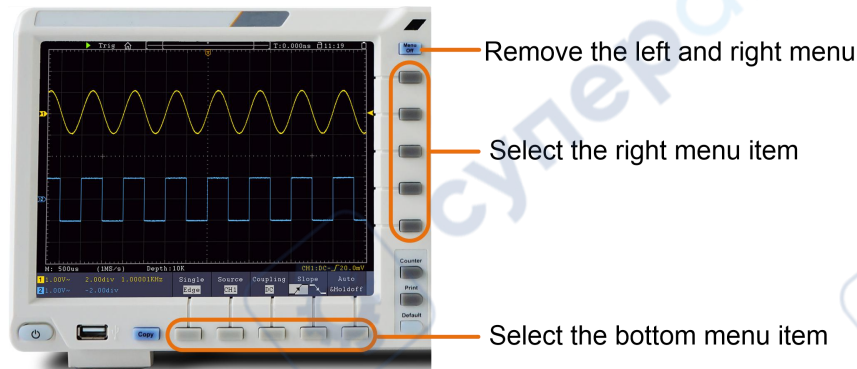


Figure 3-2 Menu Buttons

Rear Panel



Figure 3-3 Rear Panel

1. Handle.
2. Air vents.
3. Input terminals of multimeter (optional).
4. AC power input jack.
5. Fuse.
6. **Foot stool:** Adjust the tilt angle of the oscilloscope.
7. **VGA port:** To connect the oscilloscope with a monitor or a projector as VGA output (optional).
8. **LAN port:** the network port which can be used to connect with PC.

9. **USB Device port:** It is used to transfer data when external USB equipment connects to the oscilloscope regarded as "slave device". For example: to use this port when connect PC to the oscilloscope by USB.
10. **Lock Hole:** You can lock the oscilloscope to a fixed location using the security lock (please buy it yourself) to secure the oscilloscope.
11. **AV Port:** AV signal output port (optional).
12. **Trig Out(P/F)** port: Trigger signal output or Pass/Fail output, also can be used as the port of CH2 Output of optional dual-channel waveform generator. The output type can be set on the menu (Utility menu→Output→Output).
13. **Out 1** port: Output (single-channel) or CH1 Output (dual-channel) of optional waveform generator.

Control Area

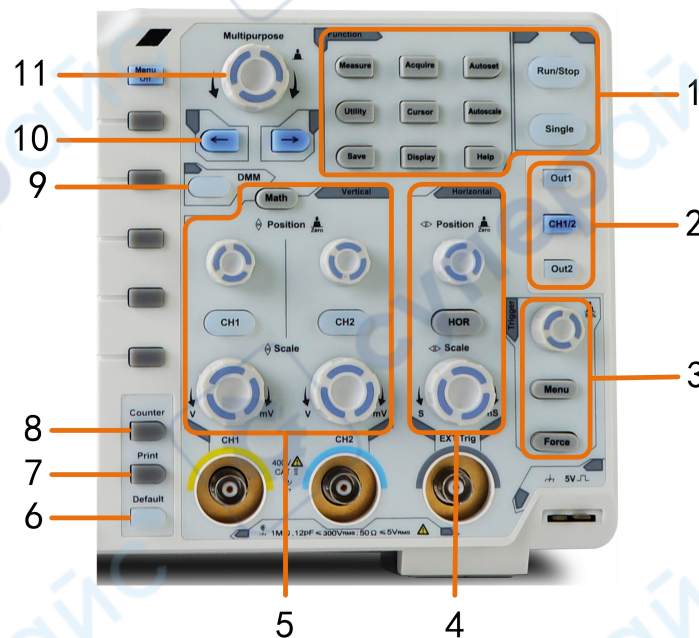


Figure 3-4 Control Area Overview

1. **Function button area:** Total 11 buttons.
2. **Waveform generator controls (optional)**
or
DAQ: Multimeter Recorder (see "*Multimeter Recorder*" on P112)
P/F: Pass/Fail (see "*Pass/Fail*" on P81)
W.REC: Waveform Record (see "*How to Record/Playback Waveforms*" on P72)
3. **Trigger control area** with 2 buttons and 1 knob.
The Trigger Level knob is to adjust trigger voltage. Other 2 buttons refer to trigger system setting.
4. **Horizontal control area** with 1 button and 2 knobs.
"HOR" button refer to horizontal system setting menu, "Horizontal Position" knob control trigger position, "Horizontal Scale" control time base.
5. **Vertical control area** with 3 buttons and 4 knobs.

"CH1" and "CH2 " correspond to setting menu in CH1 and CH2. "Math" button provides access to math waveform functions (+, -, ×, /, FFT, user function, digital filter). Two "Vertical Position" knob control the vertical position of CH1/CH2, and two "Scale" knob control voltage scale of CH1, CH2.

6. **Default:** Call out the factory settings.
7. **Print:** Print an image of what appears on the instrument screen.
8. Turn on/off the **Counter**, or turn on/off **Decode** (optional) function.
9. **DMM** (optional Multimeter) or **Snapshot** (Shortcut button for measurement snapshot)
10. **Direction key:** Move the cursor of the focused parameter.
11. **M knob** (Multipurpose knob): when a **M** symbol appears on the menu, it indicates you can turn the **M** knob to select the menu or set the value. You can push it to close the menu on the left and right.

User Interface Introduction

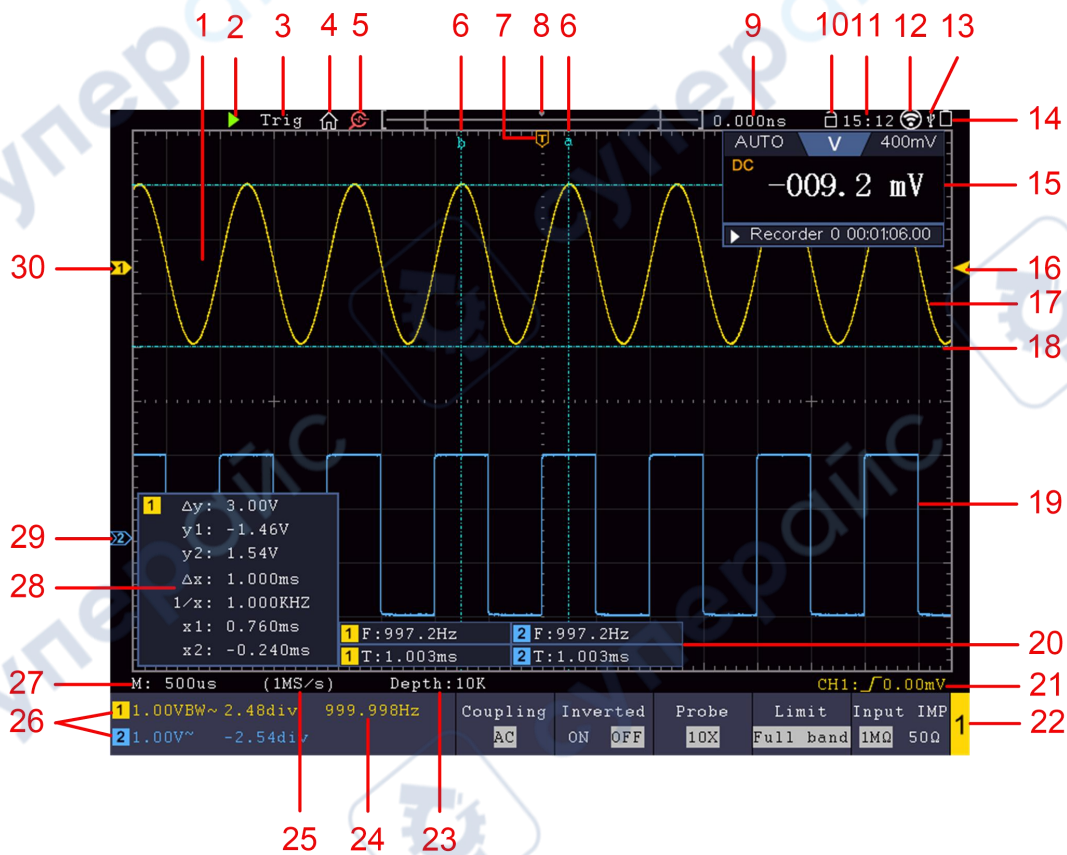





Figure 3-5 Illustrative Drawing of Display Interfaces

1. Waveform Display Area.
2. Run/Stop (touchable on touchscreen) (see "How to Use Executive Buttons" on P96)
3. The state of trigger, including:
 - Auto: Automatic mode and acquire waveform without triggering.
 - Trig: Trigger detected and acquire waveform.

Ready: Pre-triggered data captured and ready for a trigger.

Scan: Capture and display the waveform continuously.

Stop: Data acquisition stopped.

4. Click to show/hide the touchable menu pane (only for touchscreen). (see "*Operate the Menu through Touchscreen*" on P17)
5. Turn on/off the magnifier function (Only for XDS3102AP/XDS3202A with touchscreen)
6. The two blue dotted lines indicates the vertical position of cursor measurement.
7. The T pointer indicates the horizontal position for the trigger.
8. The pointer indicates the trigger position in the record length.
9. It shows present triggering value and displays the site of present window in internal memory.
10. Touchable icon is to enable () or disable () the touchscreen controls (only for touchscreen).
11. It shows setting time (see "*Config*" on P80).
12. Wi-Fi is activated (see "*Communication with Android Device via Wi-Fi (Optional)*" on P123).
13. It indicates that there is a USB disk connecting with the oscilloscope.
14. Indicating battery power status (see "*Display*" on P80).
15. Multimeter window.
16. The pointer shows the trigger level position.
17. The waveform of CH1.
18. The two blue dotted lines indicate the horizontal position of cursor measurement.
19. The waveform of CH2.
20. It indicates the measured type and value of the corresponding channel. "T" means period, "F" means frequency, "V" means the average value, "Vp" the peak-peak value, "Vr" the root-mean-square value, "Ma" the maximum amplitude value, "Mi" the minimum amplitude value, "Vt" the Voltage value of the waveform's flat top value, "Vb" the Voltage value of the waveform's flat base, "Va" the amplitude value, "Os" the overshoot value, "Ps" the Preshoot value, "RT" the rise time value, "FT" the fall time value, "PW" the +width value, "NW" the -Width value, "+D" the +Duty value, "-D" the -Duty value, "PD" the Delay A->B Φ value, "ND" the Delay A->B Ψ value, "TR" the Cycle RMS, "CR" the Cursor RMS, "WP" the Screen Duty, "RP" the Phase, "+PC" the +Pulse count, "FRR" the FRR, "FRF" the FRF, "FFR" the FFR, "FFF" the FFF, "LRR" the, "LRF" the LRF, "LFR" the LFR, "LFF" the LFF, "-PC" the -Pulse count, "+E" the Rise edge count, "-E" the Fall edge count, "AR" the Area, "CA" the Cycle area.
21. The icon shows the selected trigger type, e.g.  represents triggering on the rising edge for an Edge trigger. The reading shows the trigger level value of the corresponding channel.
22. Channel identifier of current bottom menu.
23. The readings show the record length.
24. The frequency of the trigger signal.

25. The readings show current sample rate.
26. The readings indicate the corresponding Voltage Division and the Zero Point positions of the channels. "BW" indicates bandwidth limit.
The icon shows the coupling mode of the channel.
"—" indicates direct current coupling;
"~" indicates AC coupling;
" \equiv " indicates GND coupling.
27. The reading shows the setting of main time base.
28. It is cursor measure window, showing the absolute values and the readings of the cursors.
29. The blue pointer shows the grounding datum point (zero point position) of the waveform of the CH2 channel. If the pointer is not displayed, it means that this channel is not opened.
30. The yellow pointer indicates the grounding datum point (zero point position) of the waveform of the CH1 channel. If the pointer is not displayed, it means that the channel is not opened.

How to Implement the General Inspection

After you get a new oscilloscope, it is recommended that you should make a check on the instrument according to the following steps:

1. Check whether there is any damage caused by transportation.

If it is found that the packaging carton or the foamed plastic protection cushion has suffered serious damage, do not throw it away first till the complete device and its accessories succeed in the electrical and mechanical property tests.

2. Check the Accessories

The supplied accessories have been already described in the "Appendix A: Enclosure" of this Manual. You can check whether there is any loss of accessories with reference to this description. If it is found that there is any accessory lost or damaged, please get in touch with our distributor responsible for this service or our local offices.

3. Check the Complete Instrument

If it is found that there is damage to the appearance of the instrument, or the instrument can not work normally, or fails in the performance test, please get in touch with our distributor responsible for this business or our local offices. If there is damage to the instrument caused by the transportation, please keep the package. With the transportation department or our distributor responsible for this business informed about it, a repairing or replacement of the instrument will be arranged by us.

How to Implement the Function Inspection

Make a fast function check to verify the normal operation of the instrument, according to the following steps:

1. **Connect the power cord to a power source. Long press the  button on the bottom left of the instrument.**

The instrument carries out all self-check items and shows the Boot Logo. Push the **Utility** button, select **Function** in the bottom menu. Select **Adjust** in the left menu, select **Default** in the bottom menu. The default attenuation coefficient set value of the probe in the menu is 10X.

2. **Set the Switch in the Oscilloscope Probe as 10X and Connect the Oscilloscope with CH1 Channel.**

Align the slot in the probe with the plug in the CH1 connector BNC, and then tighten the probe with rotating it to the right side.

Connect the probe tip and the ground clamp to the connector of the probe compensator.

3. **Push the Autoset Button on the front panel.**

The square wave of 1 KHz frequency and 5V peak-peak value will be displayed in several seconds (see *Figure 3-6*).

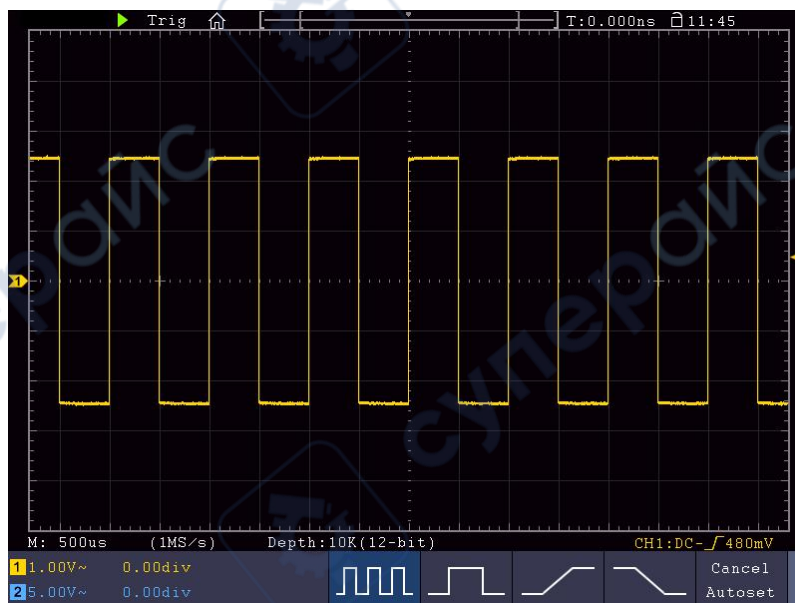


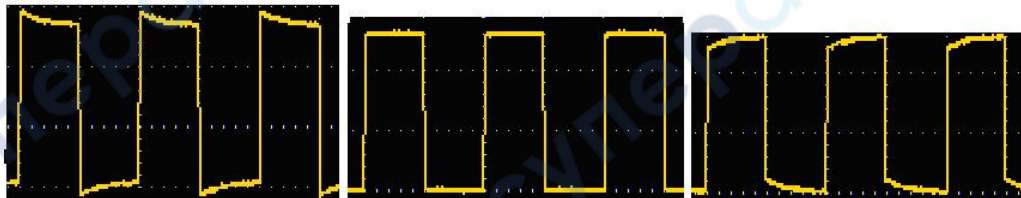
Figure 3-6 Auto set

Check CH2 by repeating Step 2 and Step 3.

How to Implement the Probe Compensation

When connect the probe with any input channel for the first time, make this adjustment to match the probe with the input channel. The probe which is not compensated or presents a compensation deviation will result in the measuring error or mistake. For adjusting the probe compensation, please carry out the following steps:

1. Set the attenuation coefficient of the probe in the menu as 10X and that of the switch in the probe as 10X (see "*How to Set the Probe Attenuation Coefficient*" on P12), and connect the probe with the CH1 channel. If a probe hook tip is used, ensure that it keeps in close touch with the probe. Connect the probe tip with the signal connector of the probe compensator and connect the reference wire clamp with the ground wire connector of the probe connector, and then push the **Autoset** button on the front panel.
2. Check the displayed waveforms and regulate the probe till a correct compensation is achieved (see *Figure 3-7* and *Figure 3-8*).



Overcompensated

Compensated correctly

Under compensated

Figure 3-7 Displayed Waveforms of the Probe Compensation

3. Repeat the steps mentioned if needed.

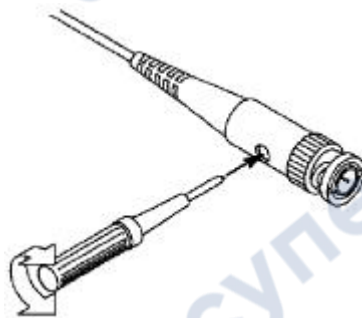


Figure 3-8 Adjust Probe

How to Set the Probe Attenuation Coefficient

The probe has several attenuation coefficients, which will influence the vertical scale factor of the oscilloscope.

To change or check the probe attenuation coefficient in the menu of oscilloscope:

- (1) Push the function menu button of the used channels (**CH1** or **CH2** button).
- (2) Select **Probe** in the bottom menu; select **Attenu** in the right menu, turn the **M** knob to

select the proper value corresponding to the probe.

This setting will be valid all the time before it is changed again.



Caution:

The default attenuation coefficient of the probe on the instrument is preset to 10X.

Make sure that the set value of the attenuation switch in the probe is the same as the menu selection of the probe attenuation coefficient in the oscilloscope.

The set values of the probe switch are 1X and 10X (see *Figure 3-9*).

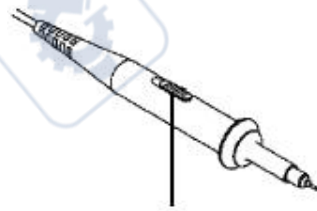


Figure 3-9 Attenuation Switch



Caution:

When the attenuation switch is set to 1X, the probe will limit the bandwidth of the oscilloscope in 5MHz. To use the full bandwidth of the oscilloscope, the switch must be set to 10X.

Identify the Probe Attenuation Coefficient Automatically

The oscilloscope can identify the probe attenuation coefficient of the 100:1 (impedance $5K \pm 20\%$) or 10:1 (impedance $10K \pm 20\%$) probe with the identifying pin. When you attach the probe, the oscilloscope set the attenuation automatically on the oscilloscope vertical menu for the channel to match the probe.

For example, if you attach a 10:1 probe with the identifying pin, the screen will prompt "The probe attenuation factor is 10X", and set the attenuation to 10X automatically on the oscilloscope vertical menu for the channel.

How to Use the Probe Safely

The safety guard ring around the probe body protects your finger against any electric shock, shown as *Figure 3-10*.

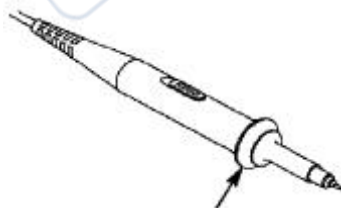


Figure 3-10 Finger Guard

**Warning:**

To avoid electric shock, always keep your finger behind the safety guard ring of the probe during the operation.

To protect you from suffering from the electric shock, do not touch any metal part of the probe tip when it is connected to the power supply.

Before making any measurements, always connect the probe to the instrument and connect the ground terminal to the earth.

How to Implement Self-calibration

The self-calibration application can make the oscilloscope reach the optimum condition rapidly to obtain the most accurate measurement value. You can carry out this application program at any time. This program must be executed whenever the change of ambient temperature is 5°C or over.

Before performing a self-calibration, disconnect all probes or wires from the input connector. Push the **Utility** button, select **Function** in the bottom menu, select **Adjust.** in the left menu, select **Self Cal** in the bottom menu; run the program after everything is ready.

Introduction to the Vertical System

As shown in *Figure 3- 11*, there are a few of buttons and knobs in **Vertical Controls**. The following practices will gradually direct you to be familiar with the using of the vertical setting.



Figure 3- 11 Vertical Control Zone

1. Use the **Vertical Position** knob to show the signal in the center of the waveform window. The **Vertical Position** knob functions the regulating of the vertical display position of the signal. Thus, when the **Vertical Position** knob is rotated, the pointer of the earth datum point of the channel is directed to move up and down following the waveform.

Measuring Skill

If the channel is under the DC coupling mode, you can rapidly measure the DC component of the signal through the observation of the difference between the wave form and the signal ground.

If the channel is under the AC mode, the DC component would be filtered out. This mode helps you display the AC component of the signal with a higher sensitivity.

Vertical offset back to 0 shortcut key

Turn the **Vertical Position** knob to change the vertical display position of channel and push the position knob to set the vertical display position back to 0 as a shortcut key, this is especially helpful when the trace position is far out of the screen and want it to get back to the screen center immediately.

2. Change the Vertical Setting and Observe the Consequent State Information Change.

With the information displayed in the status bar at the bottom of the waveform window, you can determine any changes in the channel vertical scale factor.

- Turn the **Vertical Scale** knob and change the "Vertical Scale Factor (Voltage Division)", it can be found that the scale factor of the channel corresponding to the status bar has been changed accordingly.
- Push buttons of **CH1**, **CH2** and **Math**, the operation menu, symbols, waveforms and scale factor status information of the corresponding channel will be displayed in the screen.

Introduction to the Horizontal System

Shown as *Figure 3- 12*, there are a button and two knobs in the **Horizontal Controls**. The following practices will gradually direct you to be familiar with the setting of horizontal time base.



Figure 3- 12 Horizontal Control Zone

1. Turn the **Horizontal Scale** knob to change the horizontal time base setting and

observe the consequent status information change. Turn the **Horizontal Scale** knob to change the horizontal time base, and it can be found that the **Horizontal Time Base** display in the status bar changes accordingly.

2. Use the **Horizontal Position** knob to adjust the horizontal position of the signal in the waveform window. The **Horizontal Position** knob is used to control the triggering displacement of the signal or for other special applications. If it is applied to triggering the displacement, it can be observed that the waveform moves horizontally with the knob when you rotate the **Horizontal Position** knob.

Triggering displacement back to 0 shortcut key

Turn the **Horizontal Position** knob to change the horizontal position of channel and push the **Horizontal Position** knob to set the triggering displacement back to 0 as a shortcut key.

3. Push the **Horizontal HOR** button to switch between the normal mode and the wave zoom mode.

Introduction to the Trigger System

As shown in *Figure 3-13*, there are one knob and three buttons make up **Trigger Controls**. The following practices will direct you to be familiar with the setting of the trigger system gradually.





Figure 3- 13 Trigger Control Zone

1. Push the **Trigger Menu** button and call out the trigger menu. With the operations of the menu selection buttons, the trigger setting can be changed.
2. Use the **Trigger Level** knob to change the trigger level setting. By turning the **Trigger Level** knob, the trigger indicator in the screen will move up and down. With the movement of the trigger indicator, it can be observed that the trigger level value displayed in the screen changes accordingly.
Note: Turning the **Trigger Level** knob can change trigger level value and it is also the hotkey to set trigger level as the vertical mid point values of the amplitude of the trigger signal.
3. Push the **Force** button to force a trigger signal, which is mainly applied to the "Normal" and "Single" trigger modes.

Touchscreen Controls (Touchscreen is optional)

If the LCD is touchscreen, you can control the oscilloscope by different gestures.

The touchable icon at the top right of the screen is used to enable () or disable () the touchscreen controls.


The instruction of touchscreen controls is as below. You can also use the buttons / knobs enclosed in brackets to do the same thing.

Operate the Menu through Touchscreen

- **Select a menu item:** Touch the menu items in the bottom menu, or in the right menu, or in the left menu.
- **Switch menu items:** If there are options that can be switched in the menu, you can repeatedly touch the area of the menu item to switch, or push the corresponding button to switch. See figure below.



Press repeatedly to switch the options

- **Scroll the list:** If there is a scroll bar in the left menu or in the file system window, you can swipe up and down to scroll the list.
- **Touchable menu pane:** Click the  icon on the left top of the display area, a menu pane will be shown. Clicking the menu item is same as pushing the corresponding button.

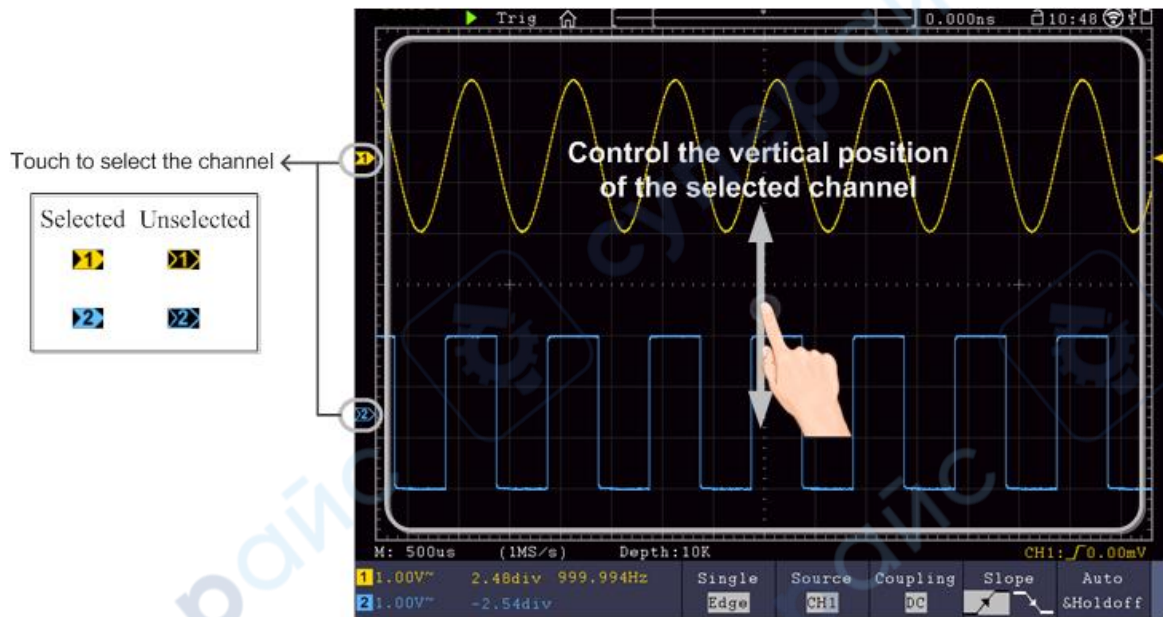


Gestures in Normal Mode

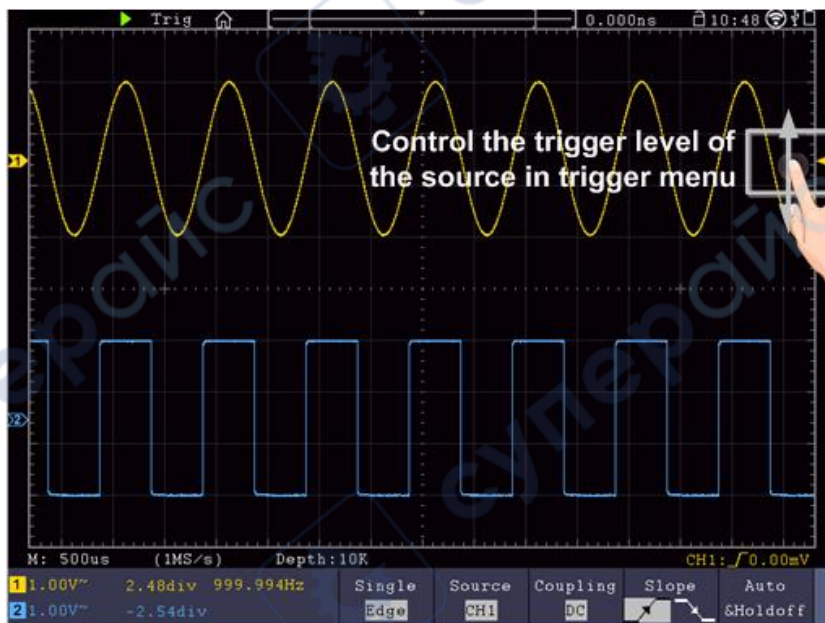
- **Select a channel (CH1 or CH2 button):** Touch the pointer on the left side of

corresponding channel to make it in selected state.

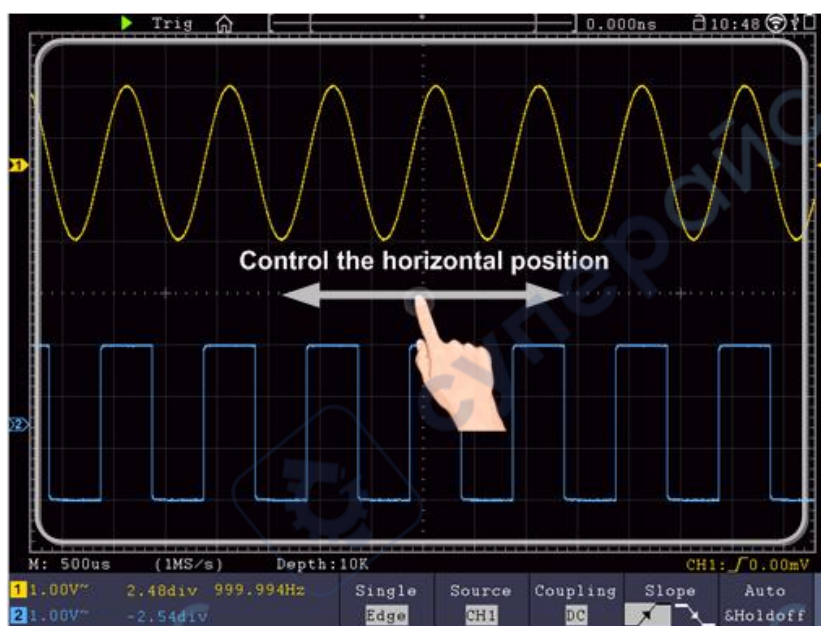
- **Set the vertical position of the selected channel (Vertical Position knob):** Swipe up or down on the screen. See figure below.



- **Set the trigger level of the source in trigger menu (Trigger Level knob):** Swipe up or down on the area nearby the trigger pointer on the right. See figure below.



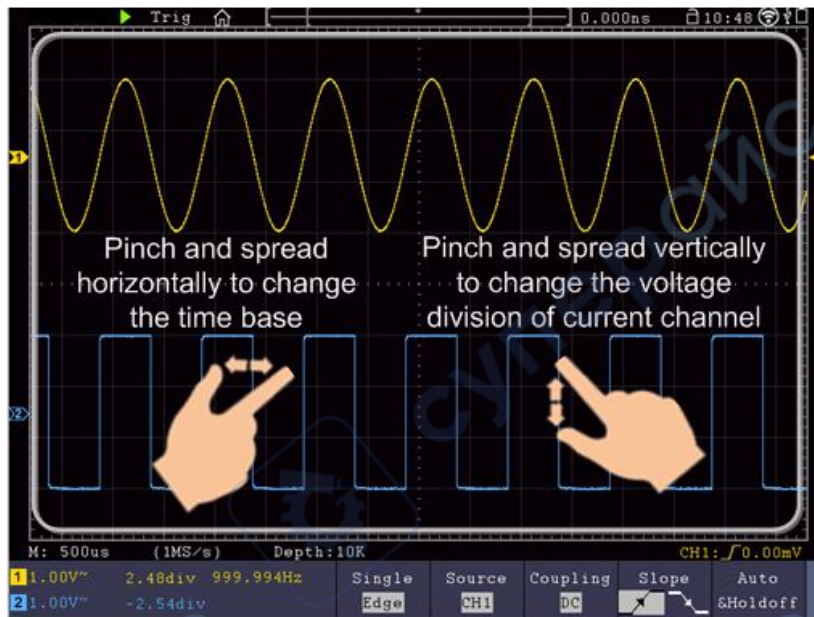
- **Set the horizontal position (Horizontal Position knob):** Swipe left or right on the display area. See figure below.



Double Zoom and Single Zoom

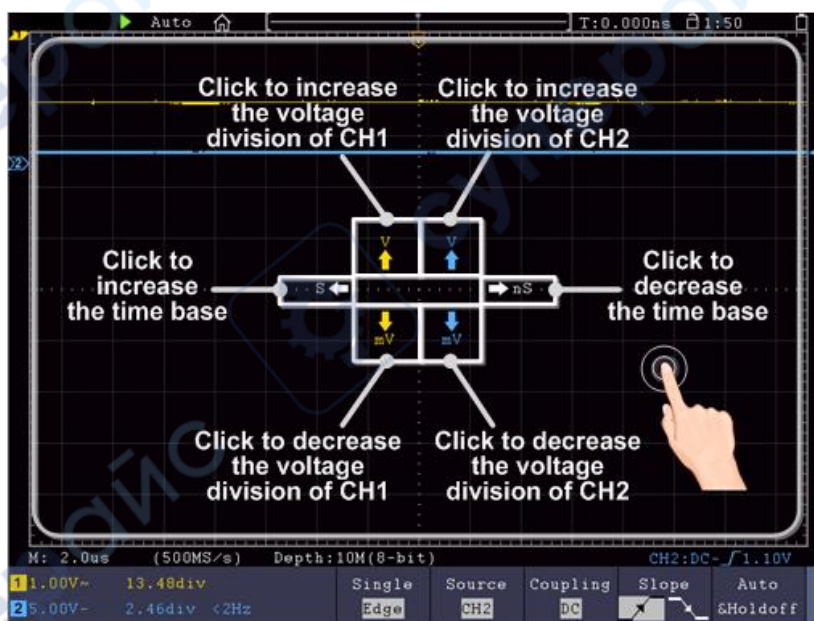
In touchable menu pane, if **DoubleZoom** is selected, in the display area, pinch and spread horizontally to change the time base; pinch and spread vertically to change the voltage division of current channel. See figure below.

Main Menu			
CH1	CH2	HOR	Out1
Trig Menu	Single	Force	Out1/2
Measure	Acquire	Autoset	Out2
Utility	Cursor	Autoscale	Math
Save	Display	Help	DMM
DoubleZoom			



In touchable menu pane, if **SingleZoom** is selected, click anywhere on the Display area to show the touching control panel. See figure below.

Main Menu			
CH1	CH2	HOR	Out1
Trig Menu	Single	Force	Out1/2
Measure	Acquire	Autoset	Out2
Utility	Cursor	Autoscale	Math
Save	Display	Help	DMM
SingleZoom			



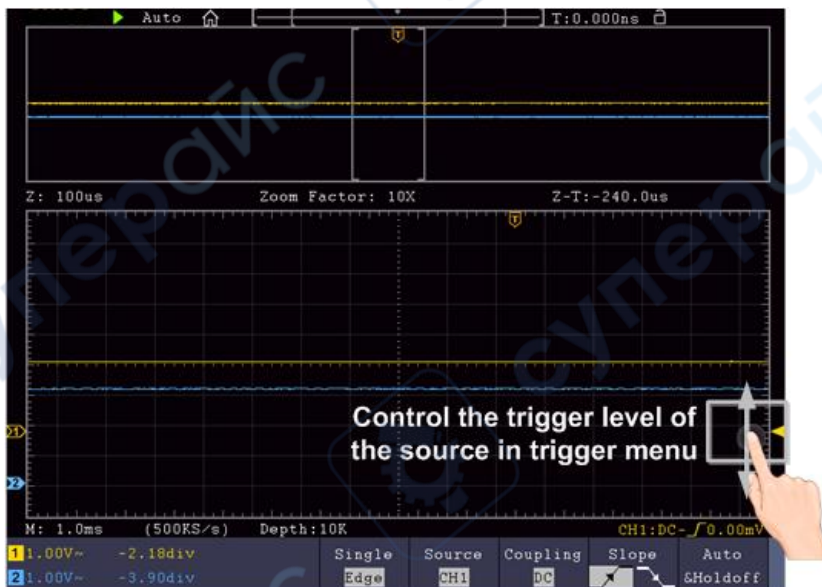
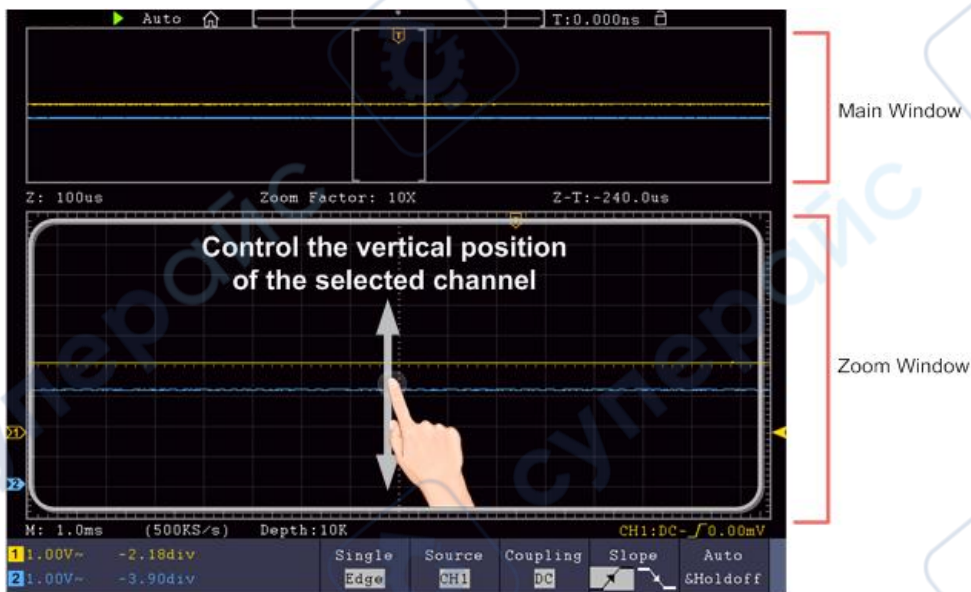
- Set the voltage division (Vertical Scale knob): Click on the left upper area to increase

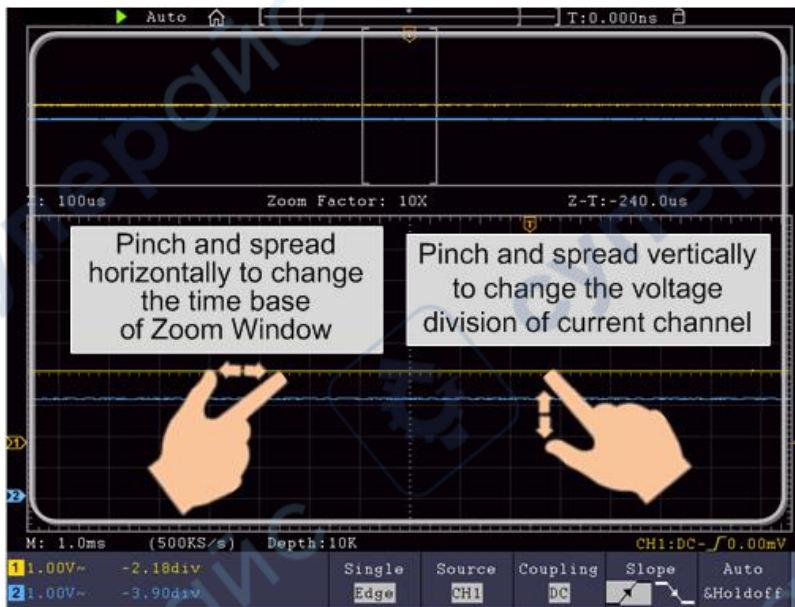
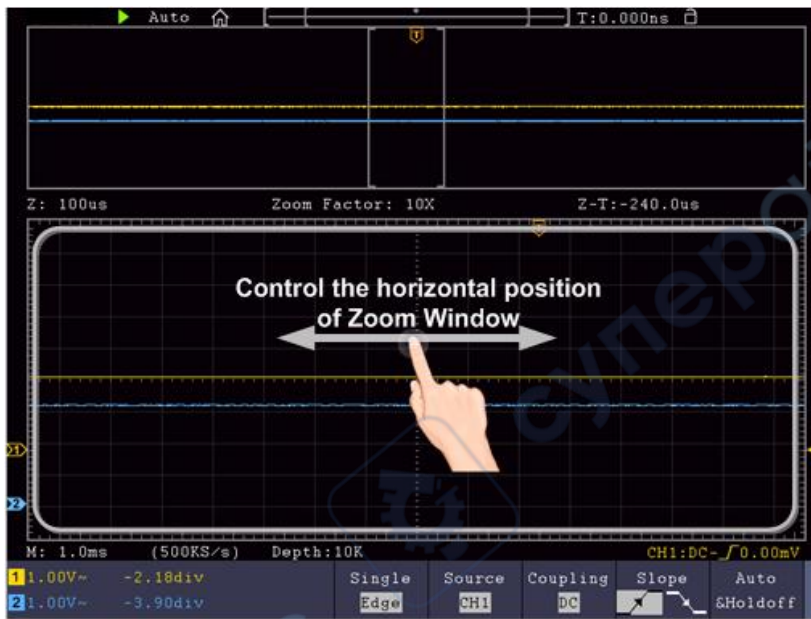
the voltage division of CH1; click on the left lower area to decrease the voltage division of CH1. Click on the right upper area to increase the voltage division of CH2; click on the right lower area to decrease the voltage division of CH2.

- **Set the horizontal time base (Horizontal Scale knob):** Click on the left area to increase the voltage division; click on the right area to decrease the voltage division.

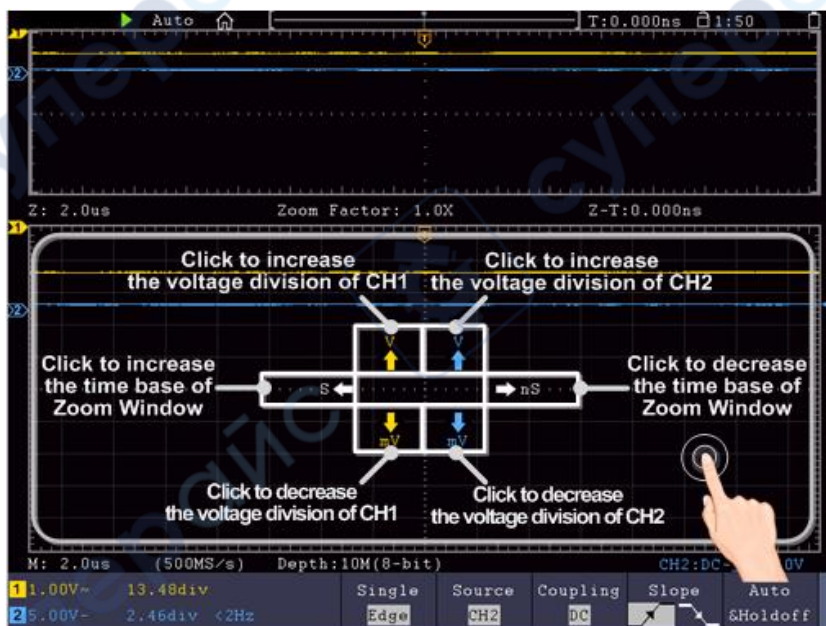
Gestures in Wave Zoom Mode

Push the **Horizontal HOR** button to enter into zoom mode. The top half of the display shows the Main window and the bottom half displays the Zoom window. The Zoom window is a magnified portion of the Main window.





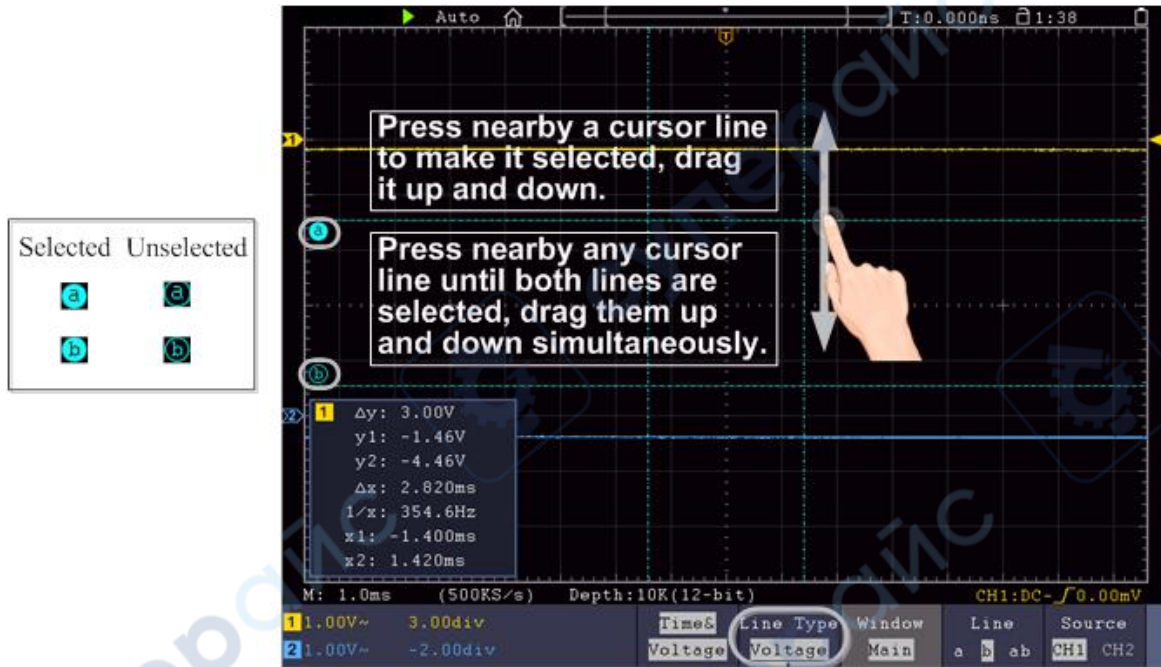
(Double Zoom)



(Single Zoom)

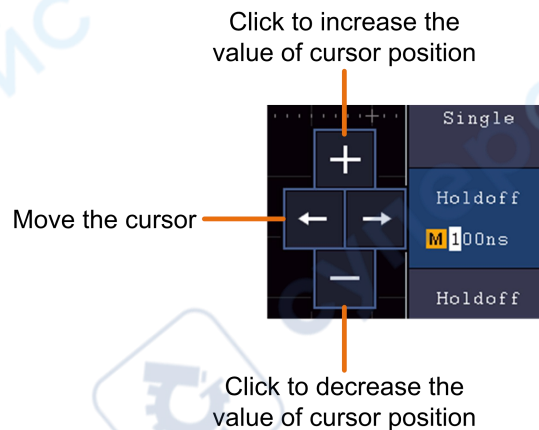
Other Operations Using Touchscreen

- Under cursor measurement, control horizontal or vertical cursor line:



Switch horizontal or vertical lines
If vertical lines are selected, drag left and right.

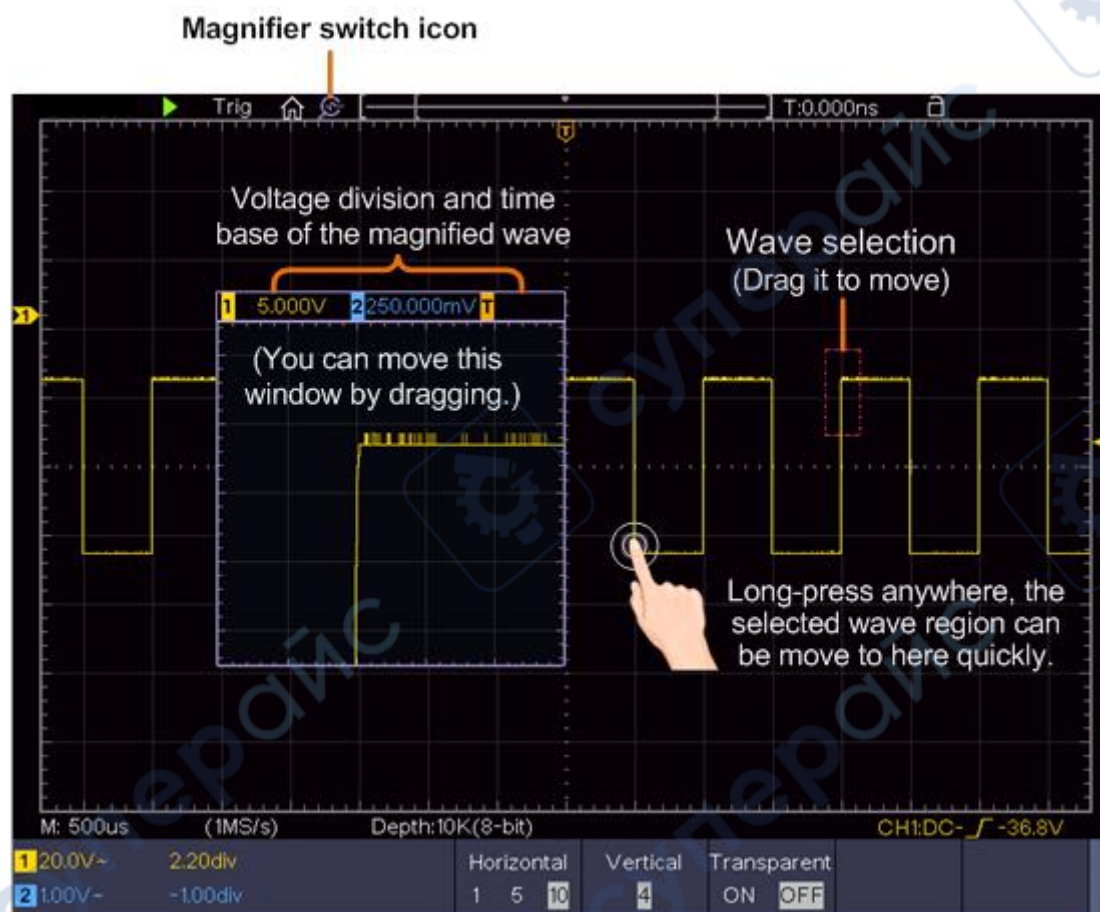
- **Run/Stop:** Double tap on the display area, or click the or on the left top of the display area to run or stop the waveform sampling.
- **Touch keyboard:** Click to input.
- **Adjust value in the menu item:** .



Magnifier Function (Only for XDS3102AP/XDS3202A with touchscreen)

The magnifier window can display the magnified wave of the wave selection, when the magnifier function is enabled.

Click the icon on the left top of the display area, the magnifier window and menu will be shown. Click the icon to turn off the magnifier function.



The description of the **Magnifier** menu is shown as follows:

Function Menu	Setting	Description
Horizontal	1	Horizontal magnification factor. The size of the magnifier window is fixed. Therefore, the greater this value, the shorter the horizontal length of the wave selection.
	5	
	10	
Vertical	1	Vertical magnification factor. The size of the magnifier window is fixed. Therefore, the greater this value, the shorter the vertical height of the wave selection.
	2	
	4	
	8	
	16	
Transparent	32	Make the magnifier window transparent or not.
	ON	
	OFF	

The Cursor Measurement in Magnifier Window

When the magnifier function is enabled, push **Cursor** panel key to display the cursor menu. In the bottom menu, select **Window** as **Main** or **Extension** to make the cursors shown in the main window or the magnifier window.



Note: The magnifier function is disabled in wave zoom mode, waveform math, FFT, XY mode, slow-scan mode, stop state, average acquire mode, and persist mode.

4. Advanced User Guidebook

Up till now, you have already been familiar with the basic operations of the function areas, buttons and knobs in the front panel of the oscilloscope. Based the introduction of the previous Chapter, the user should have an initial knowledge of the determination of the change of the oscilloscope setting through observing the status bar. If you have not been familiar with the above-mentioned operations and methods yet, we advise you to read the section of Chapter 3 "Junior User Guidebook".

This chapter will deal with the following topics mainly:

- **How to Set the Vertical System**
- **How to Set the Horizontal System**
- **How to Set the Trigger/Decoding System**
- **How to Implement the Sampling Setup**
- **How to Set the Display System**
- **How to Save and Recall Waveform**
- **How to Record/Playback Waveforms**
- **How to Clone and Recall a waveform**
- **How to Implement the Auxiliary System Function Setting**
- **How to Update your Instrument Firmware**
- **How to Measure Automatically**
- **Customize an Automatic Measurement**
- **How to Measure with Cursors**
- **How to Use Autoscale**
- **How to Use Built-in Help**
- **How to Use Executive Buttons**
- **How to Print the Screen Image**

It is recommended that you read this chapter carefully to get acquainted the various measurement functions and other operation methods of the oscilloscope.

How to Set the Vertical System

The **VERTICAL CONTROLS** includes three menu buttons such as **CH1**, **CH2** and **Math**, and four knobs such as **Vertical Position**, **Vertical Scale** for each channel.

Setting of CH1 and CH2

Each channel has an independent vertical menu and each item is set respectively based on the channel.

To turn waveforms on or off (channel, math)

Pushing the **CH1**, **CH2**, or **Math** buttons have the following effect:

- If the waveform is off, the waveform is turned on and its menu is displayed.
- If the waveform is on and its menu is not displayed, its menu will be displayed.
- If the waveform is on and its menu is displayed, the waveform is turned off and its menu goes away.

The description of the Channel Menu is shown as the following list:

Function Menu	Setting	Description
Coupling	DC AC GROUND	Pass both AC and DC components of the input signal. Block the DC component of the input signal. Disconnect the input signal.
Inverted	ON OFF	Display inverted waveform. Display original waveform.
Probe	Attenuation 0.001X 1X 0.002X 2X 0.005X 5X 0.01X 10X 0.02X 20X 0.05X 50X 0.1X 100X 0.2X 200X 0.5X 500X 1000X	Select one of the values based on the probe attenuation factor to keep the vertical gear reading accurate.
	Measure Current YES NO	If you are measuring current by probing the voltage drop across a resistor, choose YES .
	A/V (mA/V) V/A (mV/A) (When selecting the measurement current)	Turn the M knob to set the Amps/Volts ratio. The range is 100 mA/V - 1 KA/V. Amps/Volts ratio = 1/Resistor value Volts/Amp ratio is automatically calculated.
	AutoDetect YES	Click to open or close AutoDetect function.

		NO	
Limit	Full band 20M		Get full bandwidth. Limit the channel bandwidth to 20MHz to reduce display noise.
Input impedance (Applicable to some models only)	1M Ω 50 Ω		The circuit load caused by the interaction between the oscilloscope and the circuit to be measured can be reduced.
more	Tag	ON OFF	Turn channel label on or off.
	Unit	V A W U	Select the display unit of the parameter.

1. To set channel coupling

Taking the Channel 1 for example, the measured signal is a square wave signal containing the direct current bias. The operation steps are shown as below:

- (1) Push the **CH1** button to show the CH1 SETUP menu.
- (2) Select **Coupling** in the bottom menu.
- (3) Select **DC** in the right menu. Both DC and AC components of the signal are passed.
- (4) Select **AC** in the right menu. The direct current component of the signal is blocked.

2. To adjust the probe attenuation

For correct measurements, the attenuation coefficient settings in the operating menu of the Channel should always match what is on the probe (see "*How to Set the Probe Attenuation Coefficient*" on P12). If the attenuation coefficient of the probe is 1:1, the menu setting of the input channel should be set to 1X.

Take the Channel 1 as an example, the attenuation coefficient of the probe is 10:1, the operation steps are shown as follows:

- (1) Push the **CH1** button to show the CH1 SETUP menu.
- (2) Select **Probe** in the bottom menu. Select **Attenu** in the right menu, turn the **M** knob to set it as **10X**.

3. To measure current by probing the voltage drop across a resistor

Take the Channel 1 as an example, if you are measuring current by probing the voltage drop across a 1 Ω resistor, the operation steps are shown as follows:

- (1) Push the **CH1** button to show CH1 SETUP menu.
- (2) Select **Probe** in the bottom menu. In the right menu, set **MeasCurr** as **YES**, the A/V radio menu will appear below. Select it; turn the **M** knob to set the Amps/Volts ratio. Amps/Volts ratio = 1/Resistor value. Here the A/V ratio should be set to 1.

4. To invert a waveform

Waveform inverted: the displayed signal is turned 180 degrees against the phase of the earth potential.

Taking the Channel 1 for example, the operation steps are shown as follows:

- (1) Push the **CH1** button to show the CH1 SETUP menu.
- (2) Select **Inverted** in the bottom menu, switch to **ON**, the waveform is inverted. Push again to switch to **OFF**, the waveform goes back to its original one.

5. To set bandwidth limit

When high frequency components of a waveform are not important to its analysis, the bandwidth limit control can be used to reject frequencies above 20 MHz.

Taking the Channel 1 for example, the operation steps are shown as below:

- (1) Push the **CH1** button to show CH1 SETUP menu.
- (2) Select **Limit** in the bottom menu.
- (3) Select **Full band** in the right menu. The high frequency of the signal will be allowed to pass.
- (4) Select **20M** in the right menu. The bandwidth is limited to 20 MHz. The frequencies above 20MHz will be rejected.

6. Set the channel label

Set the channel label to see the location of the channel more clearly.

Take channel 1 as an example, the operation steps are as follows:

- (1) Press the CH1 button to call up the CH1 setting menu.
- (2) In the bottom menu, select **More**, in the right menu, select label **ON**, and the channel label function is turned on. Press again to select label to **OFF**, and the channel label function is turned off.

7. Set the display unit

Set the current channel amplitude display unit. The unit can be V, A, W, or U. When you change the unit, the unit in the channel status label changes accordingly.

Take channel 1 as an example, the operation steps are as follows:

- (1) Press the CH1 button to call up the CH1 setting menu.
- (2) In the bottom menu, select **More**, in the right menu, select the desired Unit. The default unit is V.

Use Mathematical Manipulation Function

The **Waveform Calculation** function is used to show the results of the addition, multiplication, division and subtraction operations between two channels, the FFT operation for a channel, advanced math feature including Intg, Diff, Sqrt, user defined function, and digital filter. Press the **Math** button to display the menu on the bottom.

The Waveform Calculation menu:

Function Menu		Setting	Description
Dual Wfm Math	Factor1	CH1 CH2	Select the signal source of the factor1.
	Sign	+ - * /	Select the sign of mathematical manipulation.
	Factor2	CH1 CH2	Select the signal source of the factor2.
	Vertical (div)	Turn the M knob to adjust the vertical position of the Math waveform.	
	Vertical (V/div)	Turn the M knob to adjust the vertical division of the Math waveform.	
FFT	Source	CH1 CH2	Select CH1 as FFT source. Select CH2 as FFT source.
	Window	Hamming Rectangle Blackman Hanning Kaiser Bartlett	Select window for FFT.
	Format	V RMS Decibels Radian Degrees	V RMS and Decibels are amplitude units; Radian and Degrees are phase units.
	Hori (Hz)	Position value Time base value/	Switch to select the horizontal position or time base of the FFT waveform, turn the M knob to adjust it.
	Vertical	Position value Division value/	Switch to select the vertical position or vertical division of the FFT waveform, turn the M knob to adjust it.
User Function	Intg, Diff, Sqrt, and user defined function.		
DIR	channel	CH1 CH2	Select channel.
	type	low-pass	Only the signals whose frequencies are lower than the current cut-off frequency can pass the filter.

		high-pass	Only the signals whose frequencies are greater than the current cutoff frequency can pass the filter.
		band-pass	Only the signals whose frequencies are greater than the cutoff frequency down and lower than the current cutoff frequency upper can pass the filter.
		band-reject	Only the signals whose frequencies are lower than the current cutoff frequency down or greater than the current cutoff frequency upper can pass the filter.
	window	rectangular tapered triangular Hanning Hamming Blackman	Select window for digital filter.
	cut-off fre or upper down		Turn the M knob to set cut-off frequency.
	Vertical (div)		Turn the M knob to adjust the vertical position of Math waveform.
FFT Peak		ON OFF	Enable or disable FFT peak search. Dynamic marker ∇ marks the FFT peak.

Waveform math

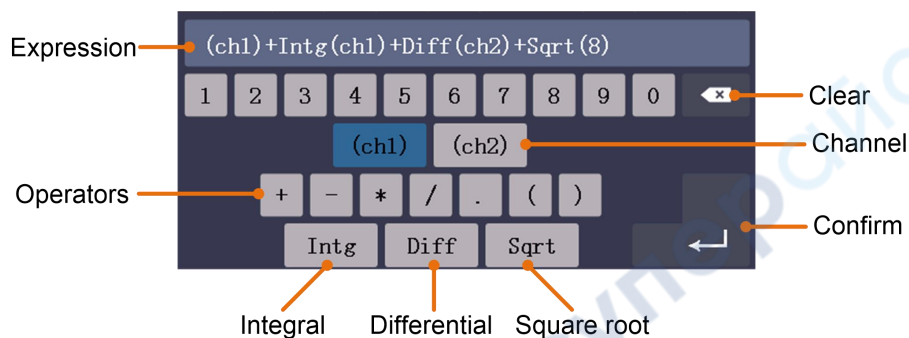
Taking the additive operation between Channel 1 and Channels 2 for example, the operation steps are as follows:

1. Press the **Math** button to display the math menu in the bottom. The pink M waveform appears on the screen.
2. Select **Dual Wfm Math** in the bottom menu.
3. In the right menu, select **Factor1** as **CH1**.
4. Select **Sign** as + in the right menu.
5. In the right menu, select **Factor2** as **CH2**.
6. Select **Vertical (div)** in the right menu, turn the **M** knob to adjust the vertical position of Math waveform.
7. Select **Vertical (V/div)** in the right menu, turn the **M** knob to adjust the vertical division of Math waveform.

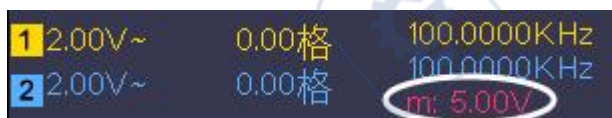
User defined function

1. Press the **Math** button to display the math menu in the bottom.

2. Select **User Function** in the bottom menu, an expression input keyboard pops up.



3. Create an expression. When done, choose \leftarrow in the keyboard to confirm. The division of Math waveform is displayed at the left bottom of screen.



Digital Filter

Digital filter provides 4 types of filters (low pass, high pass, band pass and band reject). The specified frequencies can be filtered by setting the cut-off frequency.

1. Press the **Math** button to display the math menu in the bottom.
2. Select **DIR** in the bottom menu.
3. In the right menu, select **channel** as **CH1** or **CH2**.
4. In the right menu, select **type**, select the desired filter type.
5. In the right menu, select **window**, select the desired window.
6. When **low-pass** or **high-pass** type is selected, select **cut-off fre** in the right menu. When **band-pass** or **band-reject** type is selected, select **upper** or **down** in the right menu. Turn **M** knob to adjust the frequency.
7. In the right menu, select **Vertical (div)**, turn **M** knob to adjust the vertical position of Math waveform. The voltage division of Math waveform is the same as the selected channel.

Note: On the Low-Scan format, digital filter is disabled.

Using FFT function

The FFT (fast Fourier transform) math function mathematically converts a time-domain waveform into its frequency components. It is very useful for analyzing the input signal on Oscilloscope. You can match these frequencies with known system frequencies, such as system clocks, oscillators, or power supplies.


FFT function in this oscilloscope transforms 8192 data points of the time-domain signal into its frequency components mathematically (the record length should be 10K or above). The final frequency contains 4096 points ranging from 0Hz to Nyquist frequency.

Taking the FFT operation for example, the operation steps are as follows:

1. Press the **Math** button to display the math menu in the bottom.
2. Select **FFT** in the bottom menu.
3. In the right menu, select **Source** as **CH1**.
4. In the right menu, select **Window**. In the left menu, turn the **M** knob to select the proper window type.
5. In the right menu, select **Format**. In the left menu, turn the **M** knob to select amplitude unit (**V RMS, Decibels**) or phase unit (**Radian, Degrees**).
6. Select **Hori (Hz)** in the right menu; select repeatedly to make the **M** symbol in front of the horizontal position value (the upper one), turn the **M** knob to adjust the horizontal position of FFT waveform; then select to make the **M** symbol in front of the time base value below, turn the **M** knob to adjust the time base of FFT waveform.
7. Select **Vertical** in the right menu; do the same operations as above to set the vertical position and vertical division.

To select the FFT window

■ There are 6 FFT windows. Each one has trade-offs between frequency resolution and magnitude accuracy. What you want to measure and your source signal characteristics help you to determine which window to use. Use the following guidelines to select the best window.

Type	Characteristics	Window
Hamming	<p>Better solution for magnitude than Rectangle, and good for frequency as well. It has slightly better frequency resolution than Hanning.</p> <p>Recommend to use for:</p> <ul style="list-style-type: none"> ● Sine, periodic and narrow band random noise. ● Transients or bursts where the signal levels before and after the event are significantly different. 	

4. Advanced User Guidebook




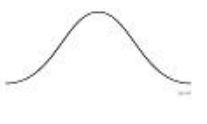
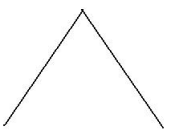
Rectangle	<p>Best solution for frequency, worst for magnitude.</p> <p>Best type for measuring the frequency spectrum of nonrepetitive signals and measuring frequency components near DC.</p> <p>Recommend to use for:</p> <ul style="list-style-type: none"> ● Transients or bursts, the signal level before and after the event are nearly equal. ● Equal-amplitude sine waves with frequencies those are very close. ● Broadband random noise with a relatively slow varying spectrum. 	
Blackman	<p>Best solution for magnitude, worst for frequency.</p> <p>Recommend to use for:</p> <ul style="list-style-type: none"> ● Single frequency waveforms, to find higher order harmonics. 	
Hanning	<p>Good for magnitude, but poorer frequency resolution than Hamming.</p> <p>Recommend to use for:</p> <ul style="list-style-type: none"> ● Sine, periodic and narrow band random noise. ● Transients or bursts where the signal levels before and after the event are significantly different. 	
Kaiser	<p>The frequency resolution when using the Kaiser window is fair; the spectral leakage and amplitude accuracy are both good.</p> <p>The Kaiser window is best used when frequencies are very close to the same value but have widely differing amplitudes (the side lobe level and shape factor are closest to the traditional Gaussian RBW). This window is also good for random signals.</p>	
Bartlett	<p>The Bartlett window is a slightly narrower variant of the triangular window, with zero weight at both ends.</p>	

Figure 4-1, Figure 4-2, Figure 4-3, Figure 4-4, Figure 4-5, Figure 4-6 are examples for measuring sine wave with a frequency of 1kHz under the selection of six different windows for FFT:

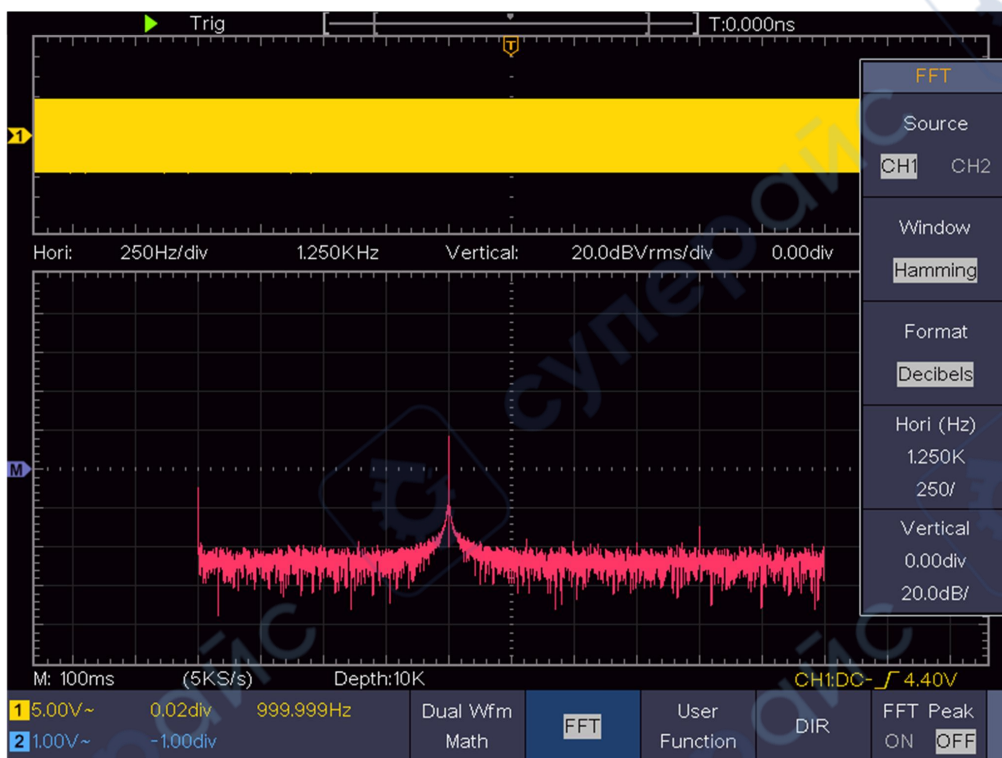


Figure 4- 1 Hamming window

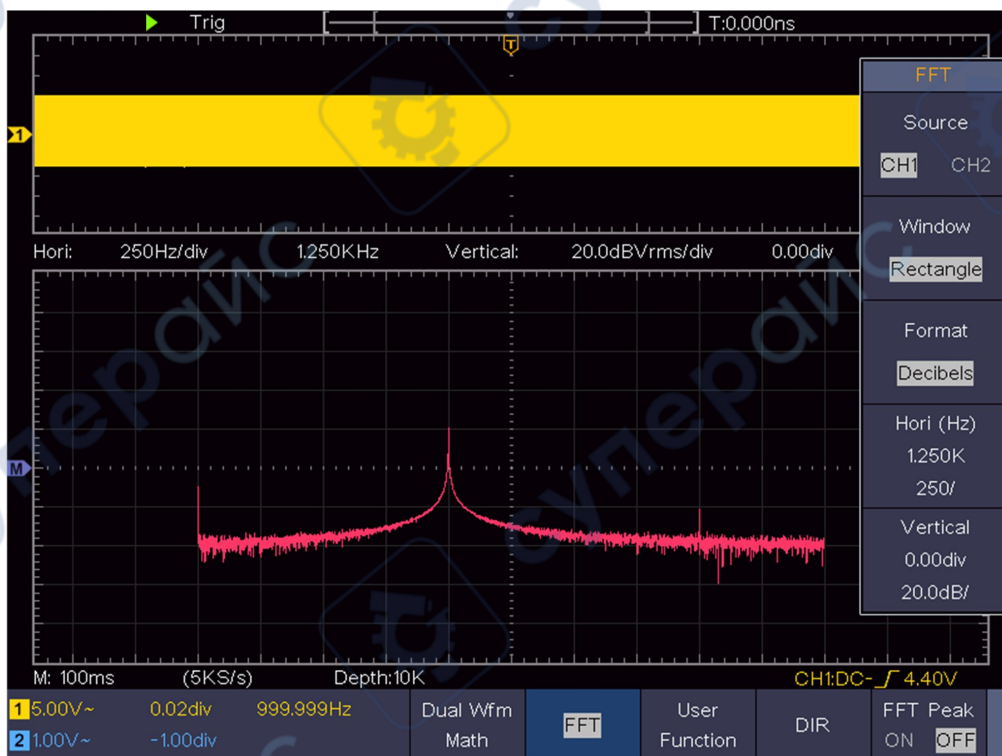


Figure 4- 2 Rectangle window

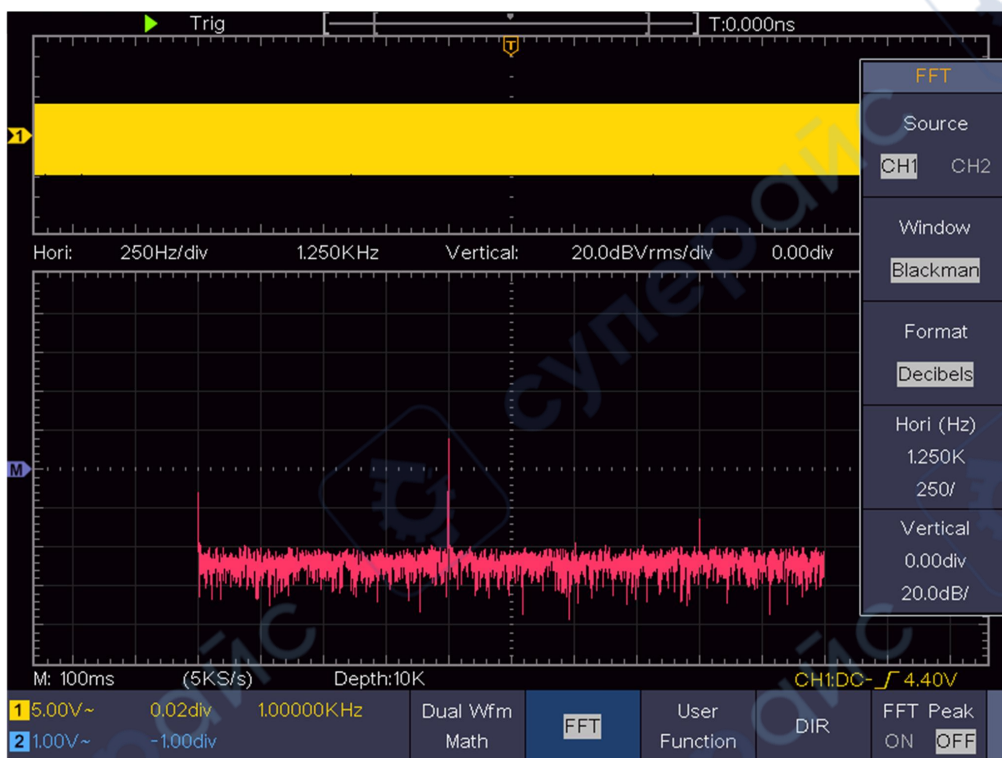


Figure 4-3 Blackman window

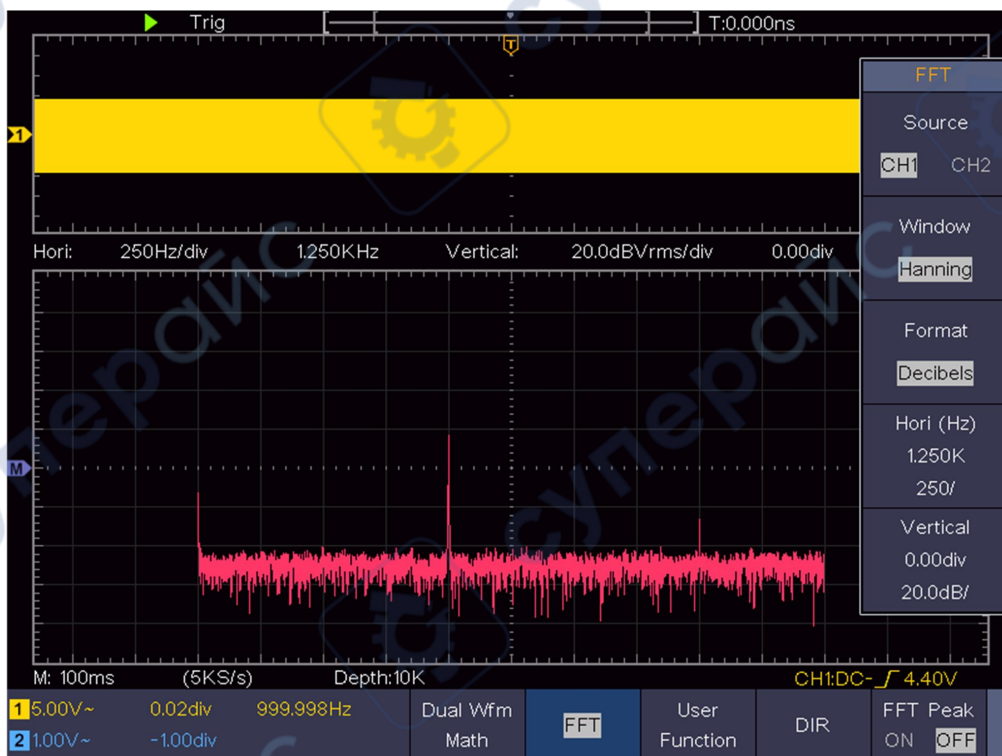


Figure 4-4 Hanning window

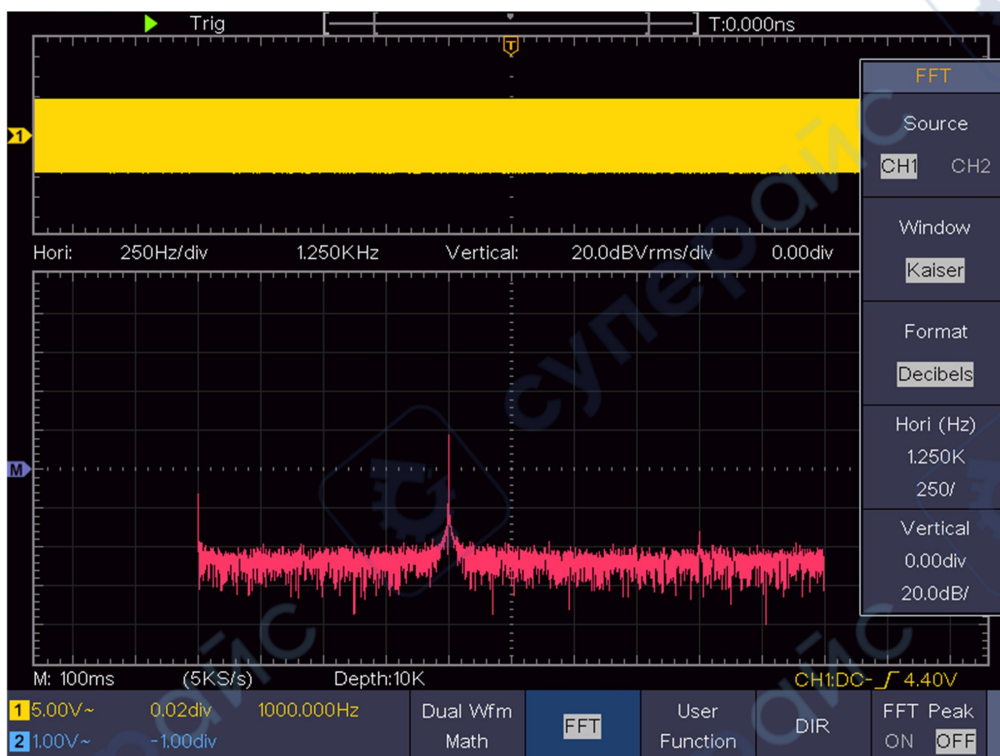


Figure 4- 5 Kaiser window

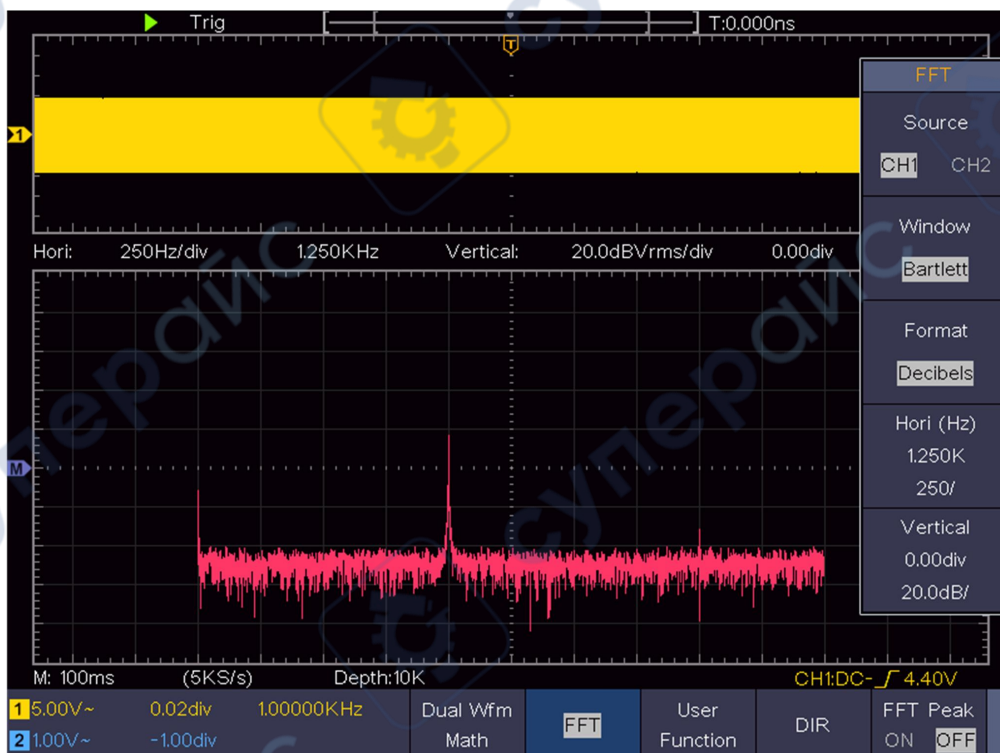


Figure 4- 6 Bartlett window

Notes for using FFT

- Use the default **dB** scale for details of multiple frequencies, even if they have very

different amplitudes. Use the **dB** scale to compare frequencies.

- DC component or offset can cause incorrect magnitude values of FFT waveform. To minimize the DC component, choose AC Coupling on the source signal.
- To reduce random noise and aliased components in repetitive or single-shot events, set the oscilloscope acquisition mode to average.

What is Nyquist frequency?

The Nyquist frequency is the highest frequency that any real-time digitizing oscilloscope can acquire without aliasing. This frequency is half of the sample rate. Frequencies above the Nyquist frequency will be under sampled, which causes aliasing. So pay more attention to the relation between the frequency being sampled and measured.

Use Vertical Position and Scale Knobs

1. The **Vertical Position** knob is used to adjust the vertical positions of the waveforms.
The analytic resolution of this control knob changes with the vertical division.
2. The **Vertical Scale** knob is used to regulate the vertical resolution of the waveforms. The sensitivity of the vertical division steps as 1-2-5.

The vertical position and vertical resolution is displayed at the left bottom corner of the screen (see *Figure 4-7*).

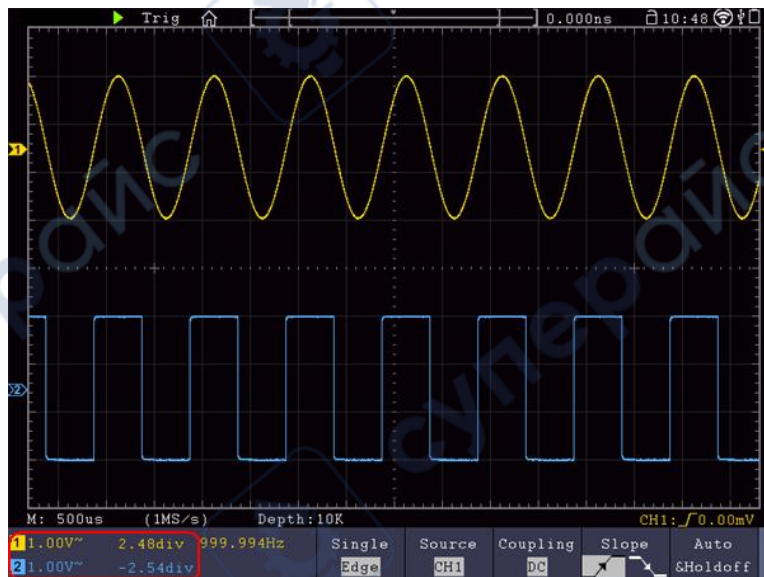


Figure 4-7 Information about Vertical Position

How to Set the Horizontal System

The **HORIZONTAL CONTROLS** includes the **Horizontal HOR** button and such knobs as **Horizontal Position** and **Horizontal Scale**.

1. **Horizontal Position** knob: this knob is used to adjust the horizontal positions of all channels (include those obtained from the mathematical manipulation), the analytic resolution of which changes with the time base.
2. **Horizontal Scale** knob: it is used to set the horizontal scale factor for setting the main time base or the window.
3. **Horizontal HOR** button: push it to switch between the normal mode and the wave zoom mode. For more detailed operations, see the introductions below.

Zoom the Waveform

Push the **Horizontal HOR** button to enter wave zoom mode. The top half of the display shows the Main window and the bottom half displays the Zoom window. The Zoom window is a magnified portion of the Main window.



In normal mode, the **Horizontal Position** and **Horizontal Scale** knobs are used to adjust the horizontal position and time base of the Main window.

In wave zoom mode, the **Horizontal Position** and **Horizontal Scale** knobs are used to adjust the horizontal position and time base of the Zoom window.

Note:

About the gestures for touchscreen, see "*Touchscreen Controls (Touchscreen is optional)*" on P17.

How to Set the Trigger/Decoding System

Trigger determines when DSO starts to acquire data and display waveform. Once trigger is set correctly, it can convert the unstable display to meaningful waveform.

When DSO starts to acquire data, it will collect enough data to draw waveform on left of trigger point. DSO continues to acquire data while waiting for trigger

condition to occur. Once it detects a trigger it will acquire enough data continuously to draw the waveform on right of trigger point.

Trigger control area consists of 1 knob and 2 menu buttons.

Trigger Level: The knob that set the trigger level; push the knob and the level will be set as the vertical mid point values of the amplitude of the trigger signal.

Force: Force to create a trigger signal and the function is mainly used in "Normal" and "Single" mode.

Trigger Menu: The button that activates the trigger control menu.

Trigger Control

The oscilloscope provides four trigger types: single trigger, alternate trigger, and bus trigger. Each type of trigger has different sub menus.

Two ways to enter trigger mode:

Key operation: Press Trigger **Menu** panel button, then bottom menu **Trigger Type**, select Single, ALT, Logic or Bus Trigger on the popup right menus, rotate M knob to choose different trigger types.

Touch operation (Optional): Click Main menu icon on the left top of the screen, select Trig Menu, click bottom button **Trigger Type**, choose Single, ALT, Logic or Bus Trigger on the popup right menus, click to choose different trigger types.

Single trigger: Use a trigger level to capture stable waveforms in two channels simultaneously.

Alternate trigger: Trigger on non-synchronized signals.

Bus trigger: Set bus timing trigger.

The **Single Trigger**, **Alternate Trigger**, and **Bus Trigger** menus are described respectively as follows:

Single Trigger

Single trigger has nine types: edge trigger, video trigger, slope trigger, pulse trigger, runt trigger, windows trigger, timeout trigger, Nth edge trigger and logic trigger.

Edge Trigger: It occurs when the trigger input passes through a specified voltage level with the specified slope.

Video Trigger: Trigger on fields or lines for standard video signal.

Slope Trigger: The oscilloscope begins to trigger according to the signal rising or falling speed.

Pulse Trigger: Find pulses with certain widths.

Runt Trigger: Trigger pulses that pass through one trigger level but fail to pass through the other trigger level.

Windows Trigger: Provide a high trigger level and low trigger level, the oscilloscope

triggers when the input signal passes through the high trigger level or the low trigger level.

Timeout Trigger: The oscilloscope triggers when the time interval from when the rising edge (or the falling edge) passes through the trigger level to when the neighbouring falling edge (or the rising edge) passes through the trigger level is greater than the timeout time set.

Nth Edge Trigger: The oscilloscope triggers on the Nth edge that appears on the specified idle time.

Logic trigger: Trigger the signal according to the condition of logic relationship.





The nine trigger modes in Single Trigger are described respectively as follows:





1. Edge Trigger

An edge trigger occurs on trigger level value of the specified edge of input signal. Select Edge trigger mode to trigger on rising edge or falling edge.

In Edge Trigger mode, the trigger setting information is displayed on bottom right of the screen, for example, **CH1:DC- \int 0.00mV**, indicates that trigger type is edge, trigger source is CH1, coupling is DC, and trigger level is 0.00mV.

Edge menu list:


Menu	Settings	Instruction
Single Mode	Edge	Set vertical channel trigger type as edge trigger.
Source	CH1	Channel 1 as trigger signal.
	CH2	Channel 2 as trigger signal.
	EXT	External trigger as trigger signal.
	EXT/5	1/5 of the external trigger signal as trigger signal.
	AC Line	AC power line as trigger signal.
Coupling	AC	Block the direct current component.
	DC	Allow all component pass.
	HF	Block the high-frequency signal, only low-frequency component pass.
	LF	Block the low-frequency signal, only high-frequency component pass. (LF menu is only for certain models)
	Noise Reject	On Off
Slope	 	Trigger on rising edge. Trigger on falling edge.
Mode&Hold	Auto	Acquire waveform even no trigger occurs.
	Normal	Acquire waveform when trigger occurs.
Single	Single	When trigger occurs, acquire one waveform then stop.
	Holdoff	100 ns - 10 s, turn the M knob or click   to set time

		interval before another trigger occur, press   panel button or click   to move cursor to choose which digit to be set.
--	--	---



Trigger Level: trigger level indicates vertical trig position of the channel, rotate trig level knob or slide on the touch screen upward and downward to move trigger level, during setting, an orange red dotted line displays to show trig position, and the value of trigger level changes at the right corner, after setting, dotted line disappears.

2. Video Trigger

Choose video trigger to trigger on fields or lines of NTSC, PAL or SECAM standard video signals.


In Video Trigger mode, the trigger setting information is displayed on bottom right of the screen, for example, , indicates that trigger type is Video, trigger source is CH1, and Sync type is Even.

Video Trigger menu list:

MENU	SETTING	INSTRUCTION
Single Mode	Video	Set vertical channel trigger type as video trigger.
Source	CH1 CH2	Select CH1 as the trigger source. Select CH2 as the trigger source.
Modu	NTSC PAL SECAM	Select video modulation.
Sync	Line Field Odd Even Line NO.	Synchronic trigger in video line. Synchronic trigger in video field. Synchronic trigger in video odd filed. Synchronic trigger in video even field. Synchronic trigger in designed video line, turn the M  knob or click  to set the line number.
Mode&Hold	Auto	Acquire waveform even no trigger occurred.


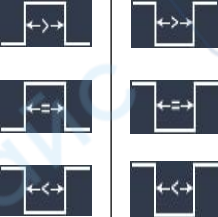









3. Pulse Width Trigger

Pulse trigger occurs according to the width of pulse. The abnormal signals can be detected through setting up the pulse width condition. In Pulse Width Trigger mode, the trigger setting information is displayed on bottom right of the screen, for example,

, indicates that trigger type is pulse width, trigger source is


CH1, coupling is DC, polarity is positive, and trigger level is 0.00mV.

Pulse Width Trigger menu list:

MENU	SETTING	INSTRUCTION
Single Mode	Pulse	Set vertical channel trigger type as pulse trigger.
Source	CH1 CH2	Select CH1 as the trigger source. Select CH2 as the trigger source.
Coupling	AC	Not allow DC portion to pass.
	DC	Allow all portion pass.
Noise Reject	On	Click to open or close Noise Reject function.
	Off	
When	Polarity 	Choose the polarity.
		Select pulse width condition and adjust the M knob  or click  to set time, press   panel button or click  to move cursor to choose which digit to be set.
Mode&Hold	Auto Normal Single Holdoff	Acquire waveform even no trigger occurred. Acquire waveform when trigger occurred. When trigger occurs, acquire one waveform then stop 100 ns - 10 s, adjust M knob or click  to set time interval before another trigger occur, press   panel button or click  to move cursor to choose which digit to be set.











4. Slope Trigger

Slope trigger sets the oscilloscope as the positive/negative slope trigger within the specified time.

In Slope Trigger mode, the trigger setting information is displayed on bottom right of the screen, for example, , indicates that trigger type is slope, trigger source is CH1, slope is rising, 0.00mV is the differential between up level and low level threshold.

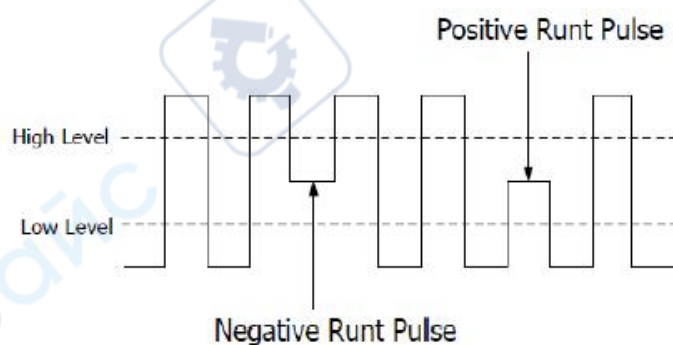
Slope trigger menu list:

MENU	SETTING	INSTRUCTION
Single Mode	Slope	Set vertical channel trigger type as slope trigger.















Source	CH1 CH2	Select CH1 as the trigger source. Select CH2 as the trigger source.
When	Slope 	Slope selecting.
		Set slope condition; turn the M knob or click  to set slope time, press   panel button or click  to move cursor to choose which digit to be set.
	Slew rate	Slew rate = (High level - Low level) / Settings
Threshold & SlewRate	High level Low level Slew rate	Adjust M knob to set the High level upper limit. Adjust M knob to set Low level lower limit. Slew rate = (High level - Low level) / Settings
Mode&Hold	Auto Normal Single Holdoff	Acquire waveform even no trigger occurred. Acquire waveform when trigger occurred. When trigger occurs, acquire one waveform then stop. 100 ns – 10 s, turn the M knob or click  to set time interval before another trigger occur, press   panel button or click  to move cursor to choose which digit to be set.

5. Runt Trigger

Trigger pulses that pass through one trigger level but fail to pass through the other trigger level. Shown as below figure, In Runt Trigger mode, the trigger setting information is displayed on bottom right of the screen, for example, **CH1: Δ 0.00mV**, indicates that trigger type is runt, trigger source is CH1, polarity is positive, 0.00mV is the differential between up level and low level threshold. See the figure.




Runt Trigger menu list:



















MENU	SETTING	INSTRUCTION
Single Mode	Runt	Set vertical channel trigger type as runt trigger.
Source	CH1 CH2	Select CH1 as the trigger source. Select CH2 as the trigger source.
Threshold	Up Level	Adjust the M knob or click  to set the up level threshold.
	Low Level	Adjust the M knob or click  to set the low level threshold.
Condition	Polarity  	Positive Polarity, the oscilloscope triggers on the positive runt pulse. Negative Polarity, the oscilloscope triggers on the negative runt pulse.
	  	Adjust the M knob or click  to set pulse width, press   panel button or click  to move cursor to choose which digit to be set. Trigger when runt pulse is greater than the set pulse width. Trigger when runt pulse equals to the set pulse width. Trigger when runt pulse is lower than the set pulse width.
Mode&Hold	Auto Normal Single	Acquire waveform even no trigger occurred. Acquire waveform when trigger occurred. When trigger occurs, acquire one waveform then stop.
	Holdoff	100 ns - 10 s, adjust M knob or click  to set time interval before another trigger occur, press  panel button or click  to move cursor to choose which digit to be set.

6.Windows Trigger

Provide a high trigger level and low trigger level, the oscilloscope triggers when the


input signal passes through the high trigger level or the low trigger level. In Windows Trigger mode, the trigger setting information is displayed on bottom right of the screen, for example, **CH1 :  Δ 0.00mV**, indicates that trigger type is windows, trigger source is CH1, polarity is positive, 0.00mV the differential between up level and low level threshold.

Windows Trigger menu list:






MENU	SETTING	INSTRUCTION
Single Mode	Windows	Set vertical channel trigger type as Windows trigger.
Source	CH1 CH2	Select CH1 as the trigger source. Select CH2 as the trigger source.
Threshold	Up Level	Adjust the M knob or click   to set the up level threshold.
	Low Level	Adjust the M knob or click   to set the low level threshold.
Condition	Polarity  	Positive Polarity, the oscilloscope triggers on the positive Windows pulse. Negative Polarity, the oscilloscope triggers on the negative Windows pulse.
	     	Enter: Triggers when the trigger signal enters the specified trigger level range. Exit: Triggers when the trigger signal exits the specified trigger level range. Time: Specify the hold time of the input signal after entering the specified trigger level. The oscilloscope triggers when the accumulated hold time is greater than the windows time. Available range is 30ns-10s, default 100ns.
Mode&Hold	Auto Normal Single	Acquire waveform even no trigger occurred. Acquire waveform when trigger occurred. When trigger occurs, acquire one waveform then stop.
	Holdoff	100 ns - 10 s, adjust M knob or click   to set time interval before another trigger occur, press   panel button or click   to move cursor to choose which digit to be set.

7. Timeout Trigger

The oscilloscope triggers when the time interval from when the rising edge (or the falling edge) passes through the trigger level to when the neighbouring falling edge (or the rising edge) passes through the trigger level is greater than the timeout time set.

In Timeout Trigger mode, the trigger setting information is displayed on bottom right of the screen, for example, , indicates that trigger type is Timeout, trigger source is CH1, edge is positive, 0.00mV is up level or low level threshold.

Timeout Trigger menu list:

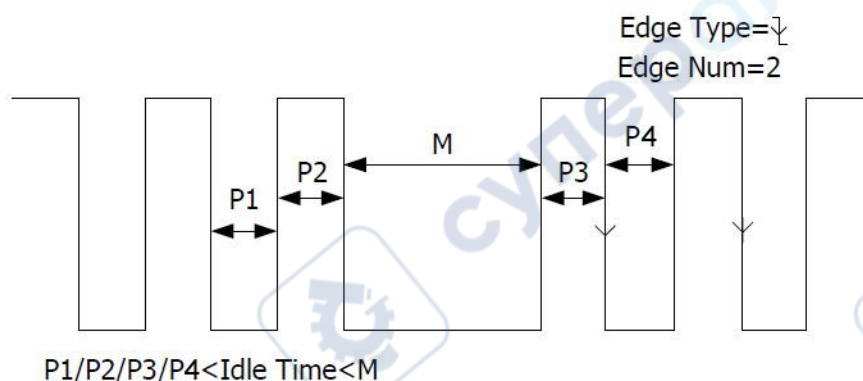
MENU	SETTING	INSTRUCTION
Single Mode	Timeout	Set vertical channel trigger type as Timeout trigger.
Source	CH1 CH2	Select CH1 as the trigger source. Select CH2 as the trigger source.
Edge	Edge 	Start timing when the rising edge of the input signal passes through the trigger level. Start timing when the falling edge of the input signal passes through the trigger level.
Configure	Idle Time	Set idle time. Idle time means the minimum time of idle clock before searching data that can meet trigger conditions. Available range is 30ns-10s, default 100ns.
Mode&Hold	Auto Normal Single Holdoff Noise Reject	Acquire waveform even no trigger occurred. Acquire waveform when trigger occurred. When trigger occurs, acquire one waveform then stop. 100 ns - 10 s, adjust M knob or click  to set time interval before another trigger occur, press   panel button or click  move cursor to choose which digit to be set. Click to open or close Noise Reject function.

8. Nth Edge trigger





The oscilloscope triggers on the Nth edge that appears on the specified idle time. As figure shown below, the oscilloscope should trigger on the second falling edge after the specified idle time and the idle time should be set to $P1/P2/P3/P4 < \text{Idle Time} < M$. Wherein, M, P1, P2, P3 and P4 are positive or negative pulse width participating in the counting.




In Nth Edge Trigger mode, the trigger setting information is displayed on bottom right

of the screen, for example, **CH1 : Nth 0.00mV**, indicates that trigger type is Nth Edge, trigger source is CH1, -150V is up level or low level threshold.




Nth Edge Trigger menu list:

MENU	SETTING	INSTRUCTION
Single Mode	Nth Edge	Set vertical channel trigger type as Nth Edge trigger.
Source	CH1 CH2	Select CH1 as the trigger source. Select CH2 as the trigger source.
Edge	Edge 	Trigger on the rising edge of the input signal when voltage level meets the specified trigger level. Trigger on the falling edge of the input signal when voltage level meets the specified trigger level.
Configure	Idle Time	Set idle time before the edge counting in Nth Edge Trigger. Adjust M knob or click  to set idle time press  panel button or click  to move cursor to choose which digit to be set. Available range is 30ns-10s, default 100ns.
	Edge Num	Set the edge number value of "N" in Nth Edge trigger.

Mode&Hold	Auto	Acquire waveform even no trigger occurred.
	Normal	Acquire waveform when trigger occurred.
	Single	When trigger occurs, acquire one waveform then stop.
	Holdoff	100 ns - 10 s, adjust M knob or click  to set time interval before another trigger occur, press  panel button or click  move cursor to choose which digit to be set.
	Noise Reject	Click to open or close Noise Reject function.




9. Logic Trigger

Trigger according to logic relation.

In Logic Trigger mode, the trigger setting information is displayed on bottom right of the screen, for example, , indicates that trigger type is Logic, logic mode is AND, CH1 high level and trigger level is 0.00mV, CH2 high level and trigger level is 0.00mV.

Logic Trigger menu list:







MENU	SETTING	INSTRUCTION
Mode	Logic	Set vertical channel trigger type as Logic trigger.
Logic Mode	AND	Set logic mode as AND.
	OR	Set logic mode as OR.
	XOR	Set logic mode as XOR.
	XNOR	Set logic mode as XNOR.
Input Mode	CH1	Set CH1 as High Level, Low level, high or low level, Rise and Fall.
	CH2	Set CH2 as High Level, Low level, high or low level, Rise and Fall. Note: When input mode of one channel is set as Rise or Fall, the other channel could not be set as Rise and Fall at the same time.
Out Mod	Goes True	Trigger when condition turns True from False.
	Goes False	Trigger when condition turns False from True.
	Is True >	Trigger when the time of true condition is more than the set time.
	Is True =	Trigger when the time of true condition is equal to the set time.
	Is True <	Trigger when the time of true condition is lower than the set time.

Mode&Hold	Auto	Acquire waveform even no trigger occurred.
	Normal	Acquire waveform when trigger occurred.
	Single	When trigger occurs, acquire one waveform then stop.
	Holdoff	100 ns - 10 s, adjust M knob or click  to set time interval before another trigger occur, press  panel button or click  move cursor to choose which digit to be set.
	Noise Reject	Click to open or close Noise Reject function.

Alternate Trigger (Trigger mode: Edge)

Trigger signal comes from two vertical channels when alternate trigger is on. This mode is used to observe two unrelated signals. Trigger mode is edge trigger.

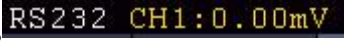
Alternate trigger (Trigger Type: Edge) menu list:

Menu	Settings	Instruction
Alternate Mode	Edge	Set vertical channel trigger type as edge trigger.
Source	CH1 CH2	Channel 1 as trigger signal. Channel 2 as trigger signal.
Coupling	AC DC	Block the direct current component. Allow all component pass.
Slope	 	Trigger on rising edge. Trigger on falling edge.
Mode&Hold	Auto Holdoff	Acquire waveform even no trigger occurs 100 ns - 10 s, turn the M knob or click  to set time interval before another trigger occur, press   panel button or click  to move cursor to choose which digit to be set.

Bus Trigger

1. RS232 Trigger

RS232 is a serial communication mode used in the data transmission between PCs or between PC and Terminal. A character is transmitted as a frame of data which consist of 1bit start bit, 5-8bits data bits, 1bit check bit and 1-2 stop bits.


In RS232 bus trigger mode, the trigger setting information is displayed on bottom right of the screen, for example, , indicates that trigger type

is RS232, CH1 trigger level is 0.00mV.

Format as shown in the figure below,



RS232 Trigger menu list:

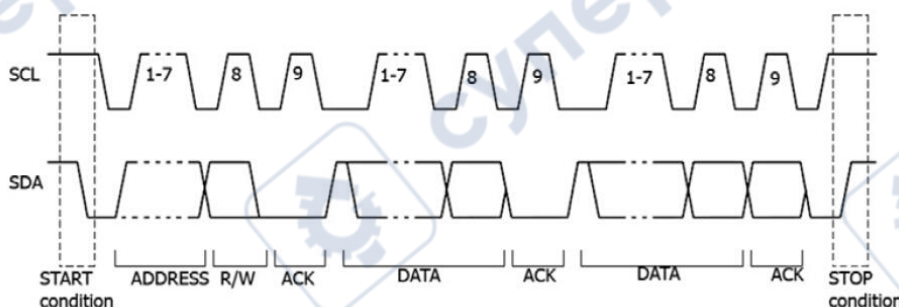
MENU	SETTING	INSTRUCTION
Bus Type	RS232	Set vertical channel bus type as RS232 trigger.
Input	Source	CH1 Select CH1 as the trigger source. CH2 Select CH2 as the trigger source.
	Polarity	 Select polarity .
	When	Start Trigger on the start frame of position. After choosing this condition, press Configure to enter detailed settings. Error Trigger when error frame is detected. After choosing this condition, press Configure to enter detailed settings. Chk Error Trigger when Chk Error is detected. After choosing this condition, press Configure to enter detailed settings. Data Trigger on the last bit of the preset data. After choosing this condition, press Configure to enter detailed settings.
Configure	Start	Common Baud: adjust M knob to choose common baud. Custom Baud: adjust M knob to choose baud, ranges from 50 to 10,000,000.
	Error	Stop Bit: Select "1" or "2". Parity: "NO" "EVEN" "ODD". Common Baud: adjust M knob to choose common baud. Custom Baud: adjust M knob to choose baud, ranges from 50 to 10,000,000.
	Chk Error	Parity: Select Even or Odd. Common Baud: adjust M knob to choose common baud. Custom Baud: adjust M knob to choose baud, ranges from 50 to 10,000,000.
	Data	Data Bits: Set as 5, 6, 7, 8 bits. Data: Set data according to data bits, ranges from 0-31, 0-63, 0-127 or 0-255.

		<p>Common Baud: adjust M knob to choose common baud.</p> <p>Custom Baud: adjust M knob to choose baud, ranges from 50 to 10,000,000.</p>
Mode	Auto Normal Single	Acquire waveform even no trigger occurred. Acquire waveform when trigger occurred. When trigger occurs, acquire one waveform then stop.

2. I2C Trigger


The I2C serial bus consists of SCL and SDA. The transmission rate is determined by SCL, and the transmission data is determined by SDA. As shown in below figure, oscilloscope can trigger on the start, restart, stop, ack lost, specific device address or data value, also device address and data value at the same time.

In I2C bus trigger mode, the trigger setting information is displayed on bottom right of the screen, for example, **I2C CH1:0.00mV CH2:0.00mV**, indicates that trigger type is I2C, CH1 trigger level is 0.00mV, CH2 trigger level is 0.00mV.



I2C Trigger menu list:

MENU	SETTING	INSTRUCTION
Bus Type	I2C	Set vertical channel bus type as I2C trigger.
Source	CH1 CH2	Set CH1 as SCL or SDA. Set CH2 as SCL or SDA.
When	Start	Trigger when SDA data transitions from high to low while SCL is high.
	Restart	When another start condition occurs before a stop condition.
	Stop	Trigger when SDA data transitions from low to high while SCL is high.
	Ack Lost	Trigger when SDA data is high during any acknowledgement of SCL clock position.
	Addr	Trigger on the read or write bit when the preset address is met.
	AdrFo Addr	Set Address Bits to be "7"、"8" or "10".

	rmat	Bits	Set address according to the preset address bits, address range is 0-127, 0-255, 0-1023 respectively. Set Data Direction to be Read or Write. Note: The set is not available when Address bits is set to "8".
		Addr	
		Direction	
	Data		Search for the preset data value on SDA and trigger on the dump edge of SCL of the last bit of the data area.
	DatFormat	Byte length	Set data byte length, available range 1-5 bytes. Adjust M knob or click  to set byte length. Select the data bit, ranges from 0 to (byte length*8 -1). Set data to be H, L or X (H or L).
CurrentBit			
Data			
All Bits		Set all the data bits to be the specified value in Data.	
Addr / Data		Trigger when Address and Data conditions are met at the same time .	
Mode	Auto Normal Single	Acquire waveform even no trigger occurred. Acquire waveform when trigger occurred. When trigger occurs, acquire one waveform then stop.	









3. SPI Trigger

Trigger on the specified data when the timeout condition is meet. When using SPI trigger, you need to specify the SCL and SDA data sources.

In SPI bus trigger mode, the trigger setting information is displayed on bottom right of the screen, for example, **SPI CH1:0.00mV CH2:0.00mV**, indicates that trigger type is SPI, CH1 trigger level is 0.00mV, CH2 trigger level is 0.00mV.

SPI Trigger menu list:

MENU	SETTING	INSTRUCTION
Bus Type	SPI	Set vertical channel bus type as SPI trigger.
Source	CH1 CH2	Set CH1 as SCL or SDA. Set CH2 as SCL or SDA.
Time Out	Time out	Set the minimum time that SCL must be idle, that is a period of SCL, available range 100ns-10s. Time out means SCL keeps idle for a specified time before oscilloscope starts to search for the data(SDA) on which to trigger.

		adjust M knob or click  to set time out, press   panel button or click  move cursor to choose which digit to be set.
ClockEdge & Data	Clock Edge  	Set Edge Clock as Rising edge or Falling edge. Means sample the SDA data on the rising edge or falling edge of the clock.
	Data Bits	Set the number of bits of the serial data character string. It can be set to any integer between 4-32. adjust M knob or click  to set Data Bits.
	Current Bit	Set the number of the data bits, ranges from 0-31, adjust M knob or click  to set Current Bit.
	Data	Set the value of the current data bit as H,L or X (H or L).
	All Bits	Set all the data bits to be the specified value in Data.
Mode	Auto Normal Single	Acquire waveform even no trigger occurred. Acquire waveform when trigger occurred. When trigger occurs, acquire one waveform then stop.

4. CAN Trigger (Optional)



CAN (Controller Area Network) is a serial communication protocol of the ISO international standardization.

By using the CAN bus trigger, you can trigger on **Start of Frame, Type of Frame, Identifier, Data, ID & Data, End of Frame, Missing Ack, or Bit Stuffing Error**. You need to specify the signal source, trigger signal type, sample point, and signal rate of the CAN signal.

In CAN bus trigger mode, the trigger setting information is displayed on bottom right of the screen, for example, **CAN CH1:-126mV**, indicates that trigger type is CAN, CH1 trigger level is -126 mV.

CAN Trigger menu list:

MENU	SETTING	INSTRUCTION	
Bus Type	CAN	Set vertical channel bus type as CAN trigger.	
Input	Source	CH1	Select CH1 as the trigger source.
		CH2	Select CH2 as the trigger source.

	Type	CAN_H CAN_L TX RX	Actual CAN_H bus signal. Actual CAN_L bus signal. Transmission signal on the CAN signal line. Received signal on the CAN signal line.	
	Sample Point		Turn the M knob (or tap on  in touchscreen) to set the Sample point, which is a point within a bit's time. The oscilloscope samples the bit level at this point. "Sample point" is represented by the percentage of "the time from the start of the bit's time to the sample point time" in the "bit's time". The range is 5% to 95%.	
	Common Baud		Turn the M knob to select from the Baud list on the left.	
	Custom Baud		Turn the M knob (or tap on  in touchscreen) to set the Baud. The range is 10,000 to 1,000,000. Tip: You can select the nearest value in Common Baud, and then adjust it in this menu.	
Condition	Start		Trigger on the start frame of the data frame.	
	Type	Type (Bottom menu)	Data	Trigger on the selected frame.
			Remote	
			Error	
			Overload	
	ID	Configure (Bottom menu)	Format	Select Standard or Extended.
			ID	Use the M knob and Direction key on the front panel to set.
	Data	Configure (Bottom menu)	Byte Length	Set the number of bytes with the M knob. The range is 1 to 8.
			Data	Set the data with the M knob and Direction key on the front panel.
	ID&Data	Configure (Bottom menu)	Format	Select Standard or Extended.
ID			Use the M knob and Direction key on the front panel to set.	
Byte Length			Set the number of bytes with the M knob. The range is 1 to 8.	
Data			Set the data with the M knob and Direction key on the front panel.	
End			Trigger on the end frame of the data frame.	
Lost			Trigger on Lost.	
Error			Trigger on Error.	

Mode	Auto Normal Single	Acquire waveform even no trigger occurred. Acquire waveform when trigger occurred. When trigger occurs, acquire one waveform then stop.
------	--------------------------	---

Bus Decoding (Optional)

1. RS232 Decoding

To decode RS232 signal:


- (1) Connect the RS232 signal to the Signal Input Channel of the oscilloscope.
- (2) Adjust to the proper time base and voltage division.
- (3) In trigger menu, select Bus trigger, and select bus type as RS232, set parameters based on the characteristics of the signal, trigger the signal correctly and obtain stable display. Refer to "RS232 Trigger" on page 50.
- (4) Push the **Decode** button on the front panel. Select bus type as RS232. set parameters based on the characteristics of the signal. When the parameters are set correctly, the information carried by the signal will be displayed.

Tip: If there are repetitive menu items in both trigger menu and decoding menu, you can set anyone of them, the other will be changed synchronously.

Note:

- Use the **Trigger Level** knob to adjust the thresholds of bus trigger and bus decoding.
- When decoding, if "Parity" is not set to "None", and the check bit error is detected, two red error marks will be displayed in the corresponding position in the waveform.

RS232 Decoding menu list:

MENU	SETTING	INSTRUCTION
Bus Type	RS232	Set bus type of decoding as RS232.
Configure	Common Baud	Turn the M knob to select from the Baud list on the left.
	Custom Baud	Turn the M knob (or tap on  in touchscreen) to set the Baud. The range is 50 to 10,000,000. Tip: You can select the nearest value in Common Baud, and then adjust it in this menu.
	Data Bits	Set the data width of each frame to match the signal. It can be set to 5, 6, 7 or 8.
	Parity	set the even-odd check mode to match the polarity used by the signal.

Display	Format	Binary Decimal Hex ASCII	Set the display format of the bus.
	EventTable	ON OFF	Select "ON" to display the event table.
	Save EventTable	If a USB storage device is currently connected to the instrument, save the event table data in a .csv (spreadsheet) formatted file on the external USB storage device.	
	ASCII Table	ON OFF	Select "ON" to display the ASCII table.

2. I2C Decoding

To decode I2C signal:

- (1) Connect the clock line (SCLK) and the data line (SDA) of the I2C signal to the Signal Input Channels of the oscilloscope.
- (2) Adjust to the proper time base and voltage division.
- (3) In trigger menu, select Bus trigger, and select bus type as I2C, set parameters based on the characteristics of the signal, trigger the signal correctly and obtain stable display. Refer to "*I2C Trigger*" on page 52.
- (4) Push the **Decode** button on the front panel. Select bus type as I2C. set parameters based on the characteristics of the signal. When the parameters are set correctly, the information carried by the signal will be displayed.

Tip: If there are repetitive menu items in both trigger menu and decoding menu, you can set anyone of them, the other will be changed synchronously.

Decoded information interpretation:

Information	Abbreviation	Background
Read Address	R, Read, or do not display	Green
Write Address	W, Write, or do not display	Green
Data	D, Data, or do not display	Black

Note:

- Use the **Trigger Level** knob to adjust the thresholds of bus trigger and bus decoding.
- When the ACK (ACKnowledge Character) is not met, two red error marks will be displayed in the corresponding position in the waveform.

I2C Decoding menu list:

MENU	SETTING	INSTRUCTION	
Bus Type	I2C	Set bus type of decoding as I2C.	
Display	Format	Binary	Set the display format of the bus.
		Decimal	
	Hex		
	ASCII		
	EventTable	ON OFF	Select "ON" to display the event table.
	Save EventTable	If a USB storage device is currently connected to the instrument, save the event table data in a .csv (spreadsheet) formatted file on the external USB storage device.	
	ASCII Table	ON	Select "ON" to display the ASCII table.
		OFF	

3. SPI Decoding

To decode SPI signal:

- (1) Connect the clock line (SCLK) and the data line (SDA) of the SPI signal to the Signal Input Channels of the oscilloscope.
- (2) Adjust to the proper time base and voltage division.
- (3) In trigger menu, select Bus trigger, and select bus type as SPI, set parameters based on the characteristics of the signal, trigger the signal correctly and obtain stable display. Refer to "*SPI Trigger*" on page 53.
- (4) Push the **Decode** button on the front panel. Select bus type as SPI. set parameters based on the characteristics of the signal. When the parameters are set correctly, the information carried by the signal will be displayed.

Tip: If there are repetitive menu items in both trigger menu and decoding menu, you can set anyone of them, the other will be changed synchronously.

Note:

- Use the **Trigger Level** knob to adjust the thresholds of bus trigger and bus decoding.
- **LS First** in Bit Order menu item (Least Significant Bit First) means that the least significant bit will arrive first: hence e.g. the hexadecimal number 0x12, will arrive as the sequence 01001000 in binary representation, will be decoded as the reversed sequence 00010010.

SPI Decoding menu list:

MENU	SETTING	INSTRUCTION
Bus Type	SPI	Set bus type of decoding as SPI.

Configure	SCLK	Select the clock edge to match the signal, sample the SDA data on the rising or falling edge of the clock.	
	Time Out	Set the minimum time that the clock (SCL) signal must be idle before the oscilloscope starts to search for the data (SDA) on which to trigger. The range is 30 ns to 10 s.	
	Data Bits	Set the data width of each frame to match the signal. It can be set to any integer between 4 and 32.	
	Bit Order	Select LS First or MS First to match the signal.	
Display	Format	Binary Decimal Hex ASCII	Set the display format of the bus.
	EventTable	ON OFF	Select "ON" to display the event table.
	Save EventTable	If a USB storage device is currently connected to the instrument, save the event table data in a .csv (spreadsheet) formatted file on the external USB storage device.	
	ASCII Table	ON OFF	Select "ON" to display the ASCII table.

4. CAN Decoding

To decode CAN signal:

- (1) Connect the CAN signal to the Signal Input Channel of the oscilloscope.
- (2) Adjust to the proper time base and voltage division.
- (3) In trigger menu, select Bus trigger, and select bus type as CAN, set parameters based on the characteristics of the signal, trigger the signal correctly and obtain stable display. Refer to "*CAN Trigger*" on page 54.
- (4) Push the **Decode** button on the front panel. Select bus type as CAN. set parameters based on the characteristics of the signal. When the parameters are set correctly, the information carried by the signal will be displayed.

Tip: If there are repetitive menu items in both trigger menu and decoding menu, you can set anyone of them, the other will be changed synchronously.

Decoded information interpretation:

Information	Abbreviation	Background
Identifier	I, ID, or do not display	Green
Overload Frame	OF	Green
Error Frame	EF	Green
Data Length code	L, DLC, or do not display	Blue
Data	D, Data, or do not display	Black

Cyclic Redundancy Check	C, CRC, or do not display	Valid: Purple Error: Red
-------------------------	---------------------------	-----------------------------

Note:

- Use the **Trigger Level** knob to adjust the thresholds of bus trigger and bus decoding.
- When the ACK (ACKnowledge Character) of Data Frame or Remote Frame is not met, two red error marks will be displayed in the corresponding position in the waveform.
- Error Frame, Remote Frame, and Overload Frame will be identified in the "Data" column in the event table (Data Frame will not be identified).

CAN Decoding menu list:

MENU	SETTING	INSTRUCTION	
Bus Type	CAN	Set bus type of decoding as CAN.	
Display	Format	Binary Decimal Hex ASCII	Set the display format of the bus.
	EventTable	ON OFF	Select "ON" to display the event table.
	Save EventTable	If a USB storage device is currently connected to the instrument, save the event table data in a .csv (spreadsheet) formatted file on the external USB storage device.	
	ASCII Table	ON OFF	Select "ON" to display the ASCII table.

How to Operate the Function Menu

The function menu control zone includes 8 function menu buttons: **Measure**, **Acquire**, **Utility**, **Cursor**, **Autoscale**, **Save**, **Display**, **Help** and 3 immediate-execution buttons: **Autoset**, **Run/Stop**, **Single**.

How to Implement Sampling Setup

Push the **Acquire** button, **Acqu Mode**, **Length**, **PERF Mode** (only for XDS3000-A series) and **Intrpl** is shown in the bottom menu.

The description of the **Acqu Mode** menu is shown as follows:

Function Menu		Setting	Description
Acqu	Sample		Normal sampling mode.

Mode	Peak Detect		Use to capture maximal and minimal samples. Finding highest and lowest points over adjacent intervals. It is used for the detection of the jamming burr and the possibility of reducing the confusion.
	Average	4, 16, 64, 128	It is used to reduce the random and don't-care noises, with the optional number of averages.

The description of the **Record Length** menu is shown as follows:

Function Menu	Setting	Description
Length	1000	Choose the record length. (For XDS3102AP/XDS3202A, 40M is available on both single CH and double CH)
	10K	
	100K	
	1M	
	10M	
	20M	
	40M (Single CH)	

The description of **PERF Mode** menu (only for XDS3000-A series) is shown as follows:

Function Menu	Setting	Description
PERF Mode	8-bit	Set the vertical resolution (A/D).
	12-bit	
	14-bit (only for XDS3102AP/XDS3202A)	

This menu is only for XDS3000-A series.

When the sample rate $\leq 250\text{MS/s}$, ADC resolution is set to 12-bit by default;

When the sample rate $> 250\text{MS/s}$, and both channels are turned on, ADC resolution is set to 8-bit by default;

When the sample rate $< 250\text{MS/s}$, and only one channel is turned on, ADC resolution can be set to 8-bit or 12-bit in this menu.

Note: For XDS3102AP/XDS3202A, the selection of 8-bit, 12-bit or 14-bit is not affected by sample rate.

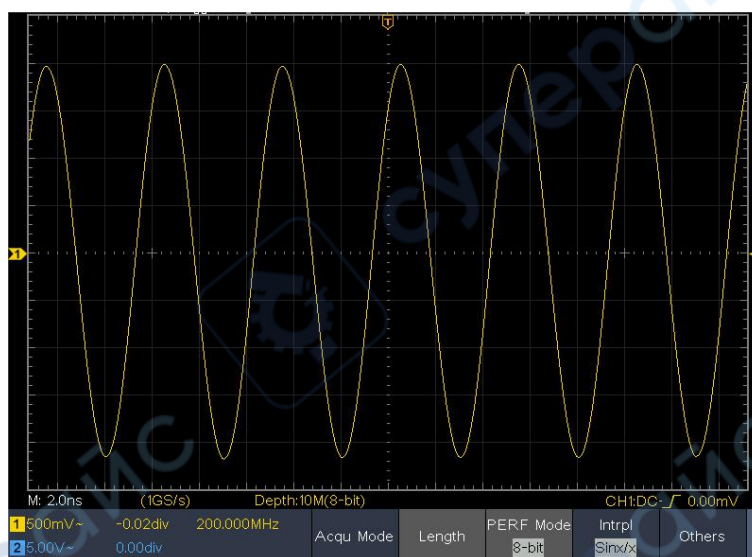
The description of the **Intrpl** menu is shown as follows:

Function Menu	Setting	Description
Intrpl	Sinx/x	Use sine(x)/x interpolation.
	x	Use linear interpolation.

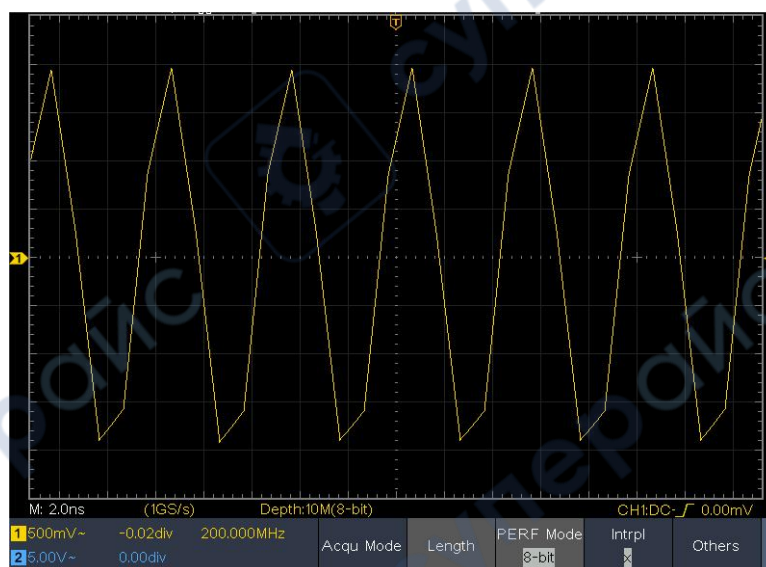
Interpolation method is a processing method to connect the sampled points, using some points to calculate the whole appearance of the waveform. Select the appropriate interpolation method according to the actual signal.

Sine(x)/x interpolation: Connect the sampled points with curved lines.

Linear interpolation: Connect the sampled points with straight lines. This method is suitable to rebuild the straight-edged signals, such as square or pulse wave.



Sine(x)/x interpolation



Linear interpolation

How to Set the Display System

Push the **Display** button and the Display menu is shown as follows:

Function Menu	Setting	Description
Type	Dots	Only the sampling points are displayed.
	Vect	The space between the adjacent sampling points in the display is filled with the vector form.

Persist &Color (Color is only for certain models)	Persist	OFF 1 Second 2 Seconds 5 Seconds Infinity	Set the persistence time.
	Color	ON OFF	Turn on/off the color temperature function.
XY Mode	Enable	ON OFF	Turn on/off XY display function.
	Full Screen	ON OFF	Turn on/off the full screen view in XY mode.
Counter		ON OFF	Turn on/off counter.
Clear			Erase the results of previous acquisitions from the display. The oscilloscope will start to accumulate acquisitions again.

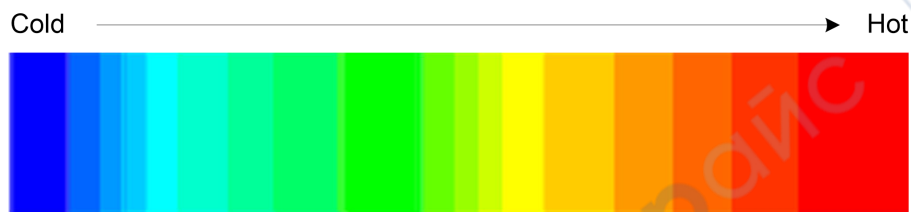
Persist

When the **Persist** function is used, the persistence display effect of the picture tube oscilloscope can be simulated. The reserved original data is displayed in fade color and the new data is in bright color.

- (1) Push the **Display** button.
- (2) Select **Persist** or **Persist&Color** in the bottom menu.
- (3) For certain models, select **Persist** in the right menu.
- (4) In the Time menu, select the persist time, including **OFF**, **1 Second**, **2 Seconds**, **5 Seconds** and **Infinity**. When the "**Infinity**" option is set for Persist Time, the measuring points will be stored till the controlling value is changed. Select **OFF** to turn off persistence and clear the display.
- (5) Select **Clear** in the bottom menu to erase the results of previous acquisitions from the display. The oscilloscope will start to accumulate acquisitions again.

Color (Only for certain models)

Color temperature function uses color-grading to indicate frequency of occurrence. The hot colors like red/yellow indicate frequently occurring events, and the colder colors like blue/green indicate rarely occurring events.



- (1) Push the **Display** button.
- (2) Select **Persist&Color** in the bottom menu.
- (3) Select **Color** in the right menu, choose between **ON/OFF**.

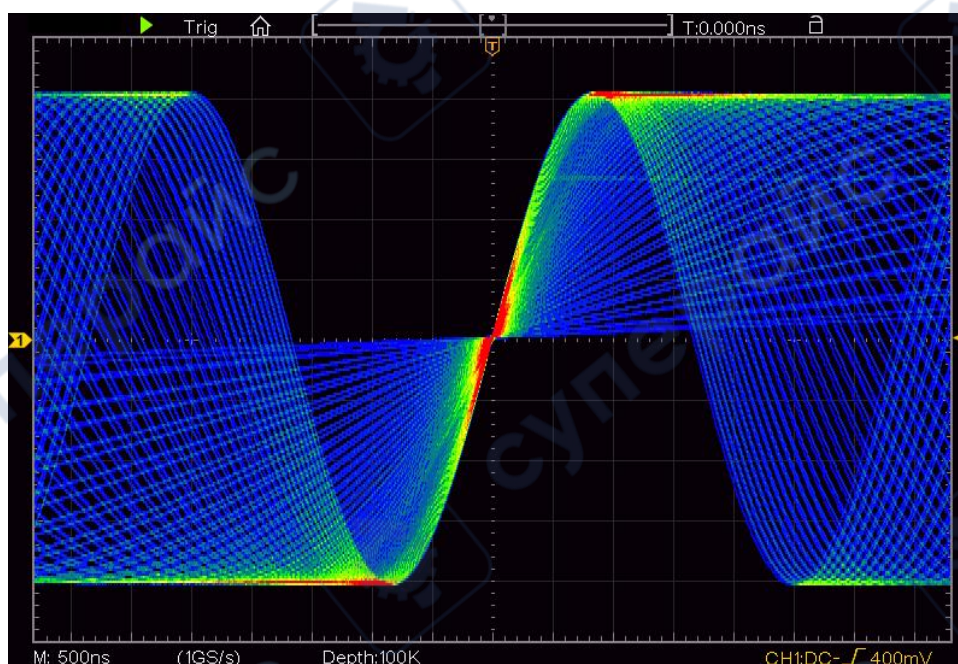


Figure 4-8 The color temperature function is on

XY Format

This format is only applicable to Channel 1 and Channel 2. After the XY display format is selected, Channel 1 is displayed in the horizontal axis and Channel 2 in the vertical axis; the oscilloscope is set in the un-triggered sample mode: the data are displayed as bright spots.

The operations of all control knobs are as follows:

- The **Vertical Scale** and the **Vertical Position** knobs of Channel 1 are used to set the horizontal scale and position.
- The **Vertical Scale** and the **Vertical Position** knobs of Channel 2 are used to set the vertical scale and position continuously.

The following functions can not work in the XY Format:

- Reference or digital wave form

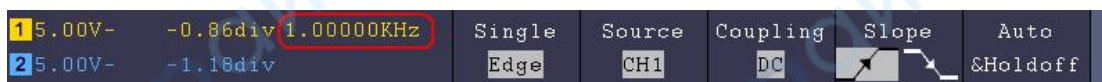
- Cursor measurement
- Trigger control
- FFT

Operation steps:

1. Push the **Display** button.
2. Select **XY Mode** in the bottom menu. Select **Enable** as **ON** in the right menu.
3. To make the XY view full screen, select **Full Screen** as **ON** in the right menu.

Counter

It is a 6-digit single-channel counter. The counter can only measure the frequency of the triggering channel. The frequency range is from 2Hz to the full bandwidth. Only if the measured channel is in **Edge** mode of **Single** trigger type, the counter can be enabled. The counter is displayed at the bottom of the screen.



Operation steps:

1. Push **Trigger Menu** button, set the trigger type to **Single**, set the trigger mode to **Edge**, select the signal source.
2. Push the **Display** button.
3. Select **Counter** as **ON** or **OFF** in the bottom menu.

How to Save and Recall a Waveform

Push the **Save** button, you can save the waveforms, configures, screen images, record or clone the waveform.

The description of the **Save Function Menu** is shown as the following table:

Function Menu	Setting	Description
Type	Wave Configure Image Record Clone	Choose the saving type. About the Record type, see "How to Record/Playback Waveforms" on P72. About the Clone type, see "How to Clone and Recall a waveform" on P75.
When the type is Wave , the menu shows as following:		
Type Wave	Format (Right menu)	For internal storage, only BIN can be selected. For external storage, the format can be BIN, TXT or CSV.

Source		CH1 CH2 Math All	Choose the waveform to be saved. (If certain channel is off, the corresponding menu item will be disabled.) (Choose All to save all the waveforms that are turned on. You can save into the current internal object address, or into USB storage as a single file.)
Object & Show	Object	0 - 99	Choose the address which the waveform is saved to or recall from.
	Show	ON OFF	Recall or close the waveform stored in the current object address. When the show is ON, if the current object address has been used, the stored waveform will be shown, the address number and relevant information will be displayed at the top left of the screen; if the address is empty, it will prompt "None is saved".
	Close All		Close all the waveforms stored in the object address.
Save			Save the waveform of the source to the selected address. Whatever the Type of save menu is set, you can save the waveform by just pressing the Copy panel button in any user interface. Select Type in the bottom menu, in the right Format menu, you can select the storage format.
Storage		Internal External	Save to internal storage or USB storage. When External is selected, save the waveform according to the current record length (see " <i>Record Length menu</i> " on P61); the file name is editable. The BIN waveform file could be open by waveform analysis software (on the supplied CD).
When the type is Configure , the menu shows as following:			
Configure		Setting0 Setting19	The setting address.
Save			Save the current oscilloscope configure to the internal storage.
Load			Recall the configure from the selected address.
When the type is Image , the menu shows as following:			

Ink Saver	ON OFF	Turn on/off the toner saving mode.
Save		Save the current display screen. The file can be only stored in a USB storage, so a USB storage must be connected first. The file name is editable. The file is stored in BMP format.


Save and Recall the Waveform

The oscilloscope can store 100 waveforms, which can be displayed with the current waveform at the same time. The stored waveform called out can not be adjusted.

In order to save the waveform of CH1, CH2 and Math into the address 1, the operation steps should be followed:

1. Turn on CH1, CH2 and Math channels.
2. Push the **Save** button.
3. **Saving:** Select **Type** in the bottom menu, select **Wave** in the left menu.
4. Select **Storage** in the bottom menu, select **Internal** in the right menu.
5. Select **Source** in the bottom menu, select **All** in the right menu for Source.
6. Select **Object & Show** in the bottom menu, select **1** as object address in the left menu.
7. Select **Save** in the bottom menu to save the waveform.
8. **Recalling:** Select **Object & Show** in the bottom menu, select **1** in the left menu. In the right menu, select **Show** as **ON**, the waveform stored in the address will be shown, the address number and relevant information will be displayed at the top left of the screen.

In order to save the waveform of CH1 and CH2 into the USB storage as a BIN file, the operation steps should be followed:

1. Turn on CH1 and CH2 channels, turn off the Math channel.
2. Push the **Save** button.
3. **Saving:** Select **Type** in the bottom menu, select **Wave** in the left menu.
4. Select **Storage** in the bottom menu, select **External** in the right menu.
5. Select **Type** in the bottom menu, select **BIN** in the right menu as the storage format.
6. Select **Source** in the bottom menu, select **All** in the right menu for Source.
7. Select **Save** in the bottom menu, an input keyboard used to edit the file name will pop up. The default name is current system date and time. Select the  key in the keyboard to confirm.



8. **Recalling:** The BIN waveform file could be open by waveform analysis software (on the supplied CD).

Tip:

Whatever the **Type** of save menu is set, you can save the waveform by just pressing the **Copy** panel button in any user interface. If the **Storage** of the save menu is set as "**External**", you should install the USB disk. Please refer to the contents below to install the USB disk and name the file to be saved.

Save the current screen image:

The screen image can only be stored in USB disk, so you should connect a USB disk with the instrument.

1. **Install the USB disk:** Insert the USB disk into the "**USB Host port**" of "*Figure 3-1 Front panel*". If an icon  appears on the top right of the screen, the USB disk is installed successfully. If the USB disk cannot be recognized, format the USB disk according to the methods in "*USB disk Requirements*" on P68.
2. After the USB disk is installed, push the **Save** panel button, the save menu is displayed at the bottom of the screen.
3. Select **Type** in the bottom menu, select **Image** in the left menu.
4. Select **Save** in the bottom menu, an input keyboard used to edit the file name will pop up. The default name is current system date and time. Select the  key in the keyboard to confirm.

USB disk Requirements

The supported format of the USB disk: FAT32 file system, the allocation unit size cannot exceed 4K, mass storage USB disk is also supported. If the USB disk doesn't work properly, format it into the supported format and try again. Follow any of the following two methods to format the USB disk: using system-provided function and using the formatting tools. (The USB disk of 8 G or 8 G above can only be formatted using the second method – using the formatting tools.)

Use system-provided function to format the USB disk

1. Connect the USB disk to the computer.
2. Right click **Computer**-> **Manage** to enter Computer Management interface.
3. Click Disk Management menu, and information about the USB disk will display on the right side with red mark 1 and 2.

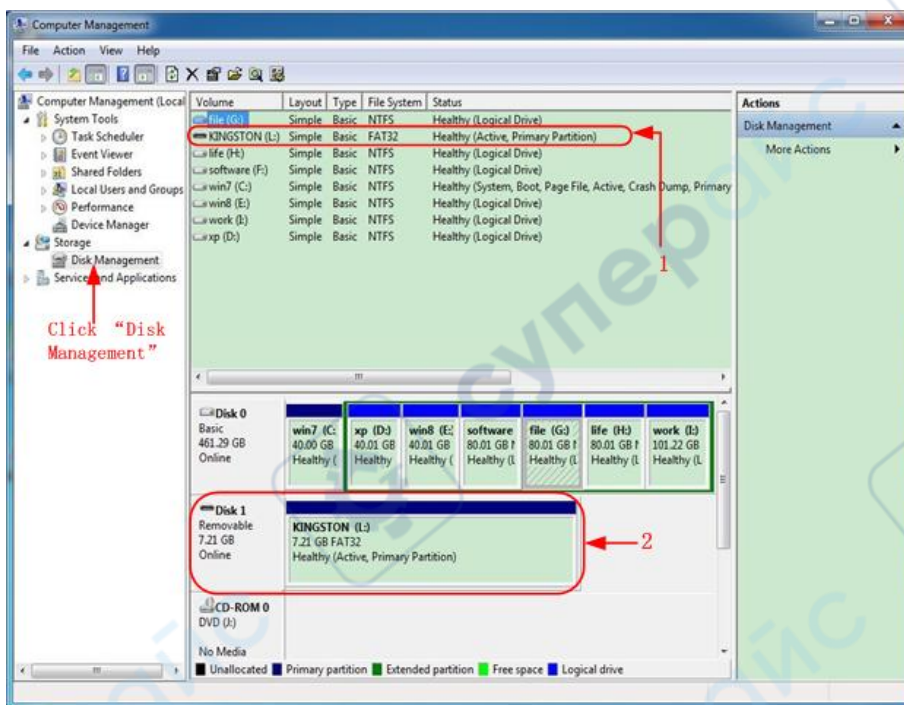


Figure 4- 9: Disk Management of computer

- Right click 1 or 2 red mark area, choose **Format**. And system will pop up a warning message, click **Yes**.

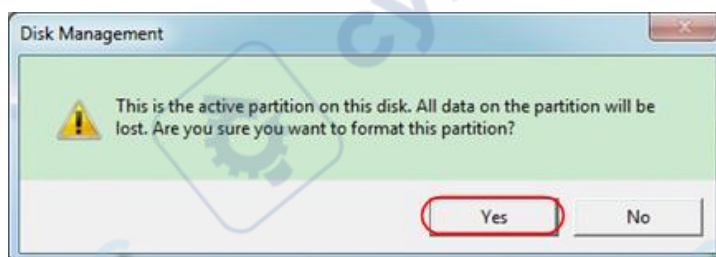


Figure 4- 10: Format the USB disk warning

- Set File System as FAT32, Allocation unit size 4096. Check "**Perform a quick format**" to execute a quick format. Click **OK**, and then click **Yes** on the warning message.

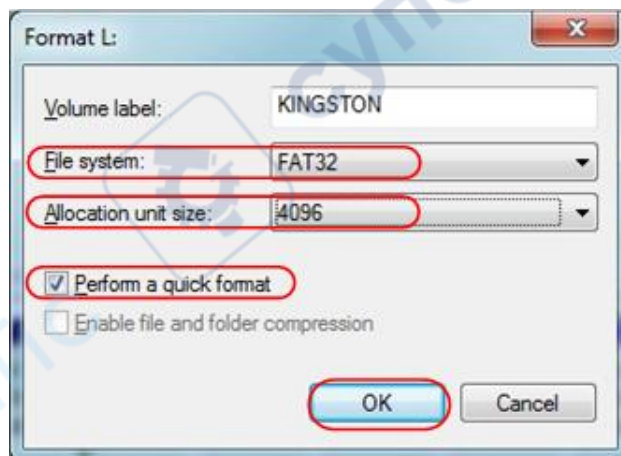


Figure 4- 11: Formatting the USB disk setting

6. Formatting process.

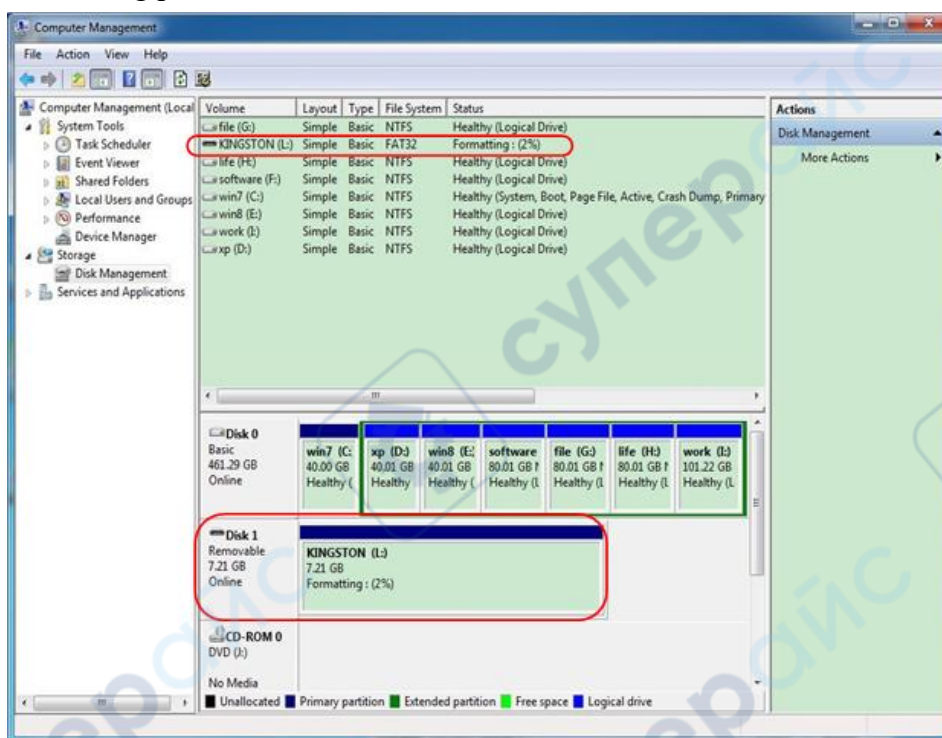


Figure 4- 12: Formatting the USB disk

7. Check whether the USB disk is FAT32 with allocation unit size 4096 after formatting.

Use Minitool Partition Wizard to format

Download URL: <http://www.partitionwizard.com/free-partition-manager.html>

Tip: There are many tools for the USB disk formatting on the market, just take Minitool Partition Wizard for example here.

1. Connect the USB disk to the computer.
2. Open the software **Minitool Partition Wizard**.
3. Click **Reload Disk** on the pull-down menu at the top left or push keyboard F5, and information about the USB disk will display on the right side with red mark 1 and 2.

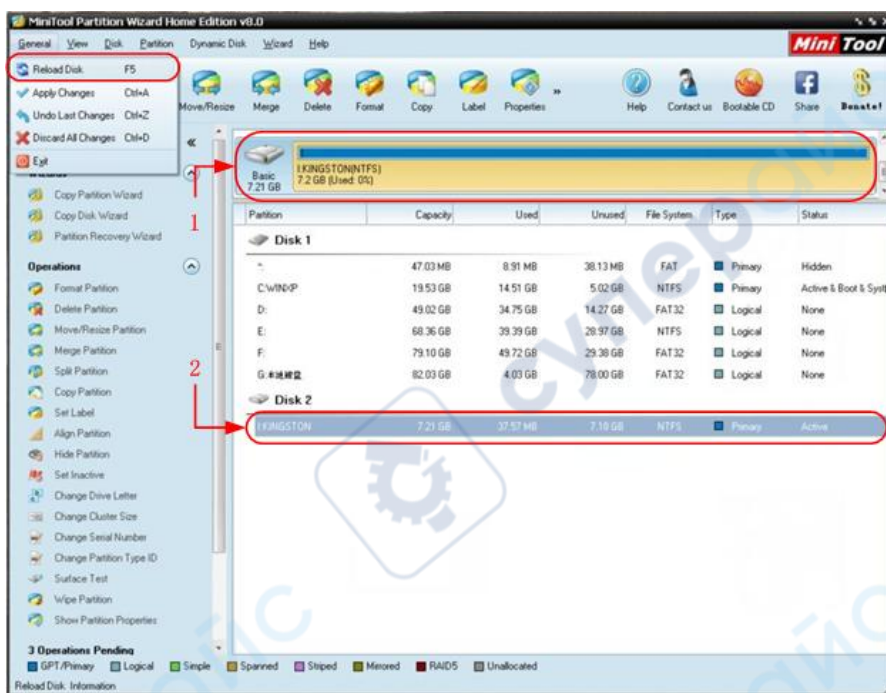


Figure 4- 13: Reload Disk

- Right click 1 or 2 red mark area, choose **Format**.



Figure 4- 14: Choose format

- Set File System FAT32, Cluster size 4096. Click **OK**.



Figure 4- 15: Format setting

- Click **Apply** at the top left of the menu. Then click **Yes** on the pop-up warning to begin formatting.

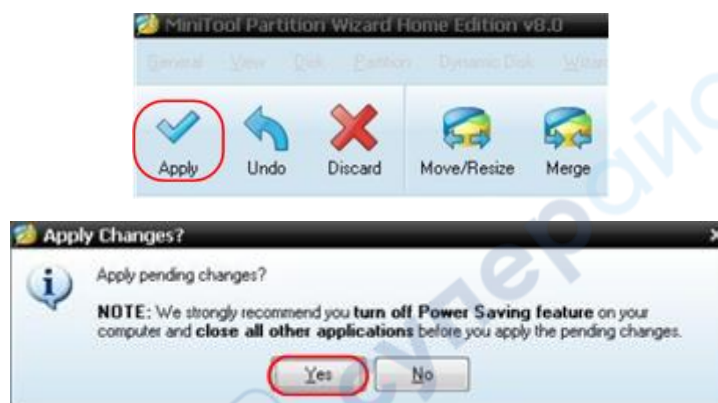


Figure 4- 16: Apply setting

7. Formatting process

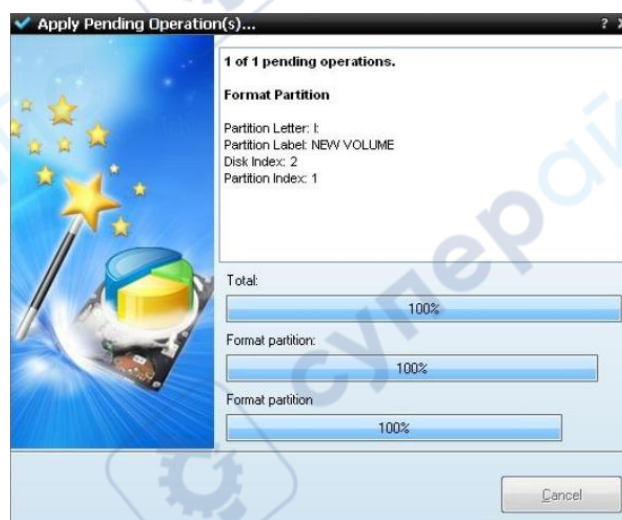


Figure 4- 17: Format process

8. Format the USB disk successfully

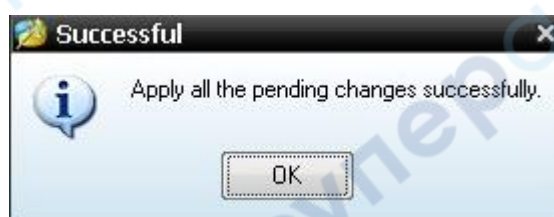


Figure 4- 18: Format successfully

How to Record/Playback Waveforms

Wave Record function can record the input current wave. You can set the interval between recorded frames in the range of 10 ms - 10 s. The max frame number reaches 1000, and you can get better analysis effect with playback and storage function. The storage medium contains two kinds: Internal and External.

When the storage medium is Internal, Wave Record contains four modes: **OFF**, **Record**, **Playback** and **Storage**.

When storage medium is External, Wave Record contains two modes: **OFF**, **Record**.

Record: To record wave according to the interval until it reaches the end frame set.

Record menu (Internal Storage) shows as follows:

Menu	Setting	Instruction
Mode	OFF	Close wave record function.
	Record	Set record menu.
	Playback	Set playback menu.
	Storage	Set storage menu.
Record mode FrameSet	End frame	Turn the M knob to select the number of frames to record (1 - 1000).
	Interval	Turn the M knob to select the interval between recorded frames (10ms - 10s).
Refresh	ON	Refresh wave during recording.
	OFF	Stop refreshing.
Operate	Play	Begin to record.
	Stop	Stop recording.

Note:

Both of the waveforms of Channel 1 and Channel 2 will be recorded. If a Channel is turned off while recording, the waveform of the channel is invalid in the playback mode.

Playback: Play back the wave recorded or saved.

Playback menu shows as follows:

Menu	Setting	Instruction
Playback Mode FrameSet	Start frame	Turn the M knob to select the number of start frame to playback (1 - 1000).
	End frame	Turn the M knob to select the number of end frame to playback (1 - 1000).
	Cur frame	Turn the M knob to select the number of current frame to playback (1 - 1000).
	Interval	Turn the M knob to select the interval between played back frames (10ms - 10s).
Playmode	Loop	Play back the wave continuously.
	Once	Play back the wave just one time.
Operate	Play	Begin to record.
	Stop	Stop recording.

Storage: Save the current wave according to the start frame and end frame set.

Storage menu shows as follows:

Menu	Setting	Instruction
Storage Mode	Start frame	Turn the M knob to select the number of start frame to store (1 - 1000).

FrameSet	End frame	Turn the M knob to select the number of end frame to store (1 - 1000).
Save		Save the waveform record file to the internal memory.
Load		Load the waveform record file from the memory.

To use wave record function, do as follows:

- (1) Push **Save** button.
- (2) Select **Type** in the bottom menu, in the left menu, turn the **M** knob to select **Record**.
- (3) Select **Mode** in the bottom menu, select **OFF** in the right menu.
- (4) In the bottom menu, select **Storage** as **Internal**.
- (5) Select **Mode** in the bottom menu, select **Record** in the right menu.
- (6) Select **FrameSet** in the bottom menu, set **End frame** and **Interval** in the right menu.
- (7) In the bottom menu, set **Refresh**.
- (8) In the bottom menu, select **Operate** as **Play**.
- (9) Select **Mode** in the bottom menu, select **Playback** in the right menu. Set **FrameSet** and **Playmode**, select **Operate** as **Play**.
- (10) To save the wave recorded, select **Mode** in the bottom menu, select **Storage** in the right menu. Select **FrameSet** in the bottom menu to set the range of frames to store, select **Save** in the bottom menu.
- (11) To load the waveform from the internal memory, select **Load** in the bottom menu, then enter the **Playback** of the **Mode** to analyze the wave.

Note: When playing the waveform, the sampling, trigger, or display function is not available.

When storage medium is External, Wave Record contains two modes: OFF, Record.

Record menu (External Storage) shows as follows:

Menu	Setting	Instruction
Mode	OFF Record	Close wave record function. Set record menu.
Record mode FrameSet	End frame	Turn the M knob to select the number of frames to record (1 - 900,000).
	Interval	Turn the M knob to select the interval between recorded frames (10ms - 10s).
	Infinity	Record infinitely until the storage medium is full.
Refresh	ON OFF	Refresh wave during recording. Stop refreshing.
Operate	Play Stop	Begin to record. Stop recording.

Note:

Both of the waveforms of Channel 1 and Channel 2 will be recorded. If a Channel is turned off while recording, the waveform of the channel is invalid in the playback

mode.

To use wave record to external, do as follows:

1. Push **Save** button.
2. Select **Type** in the bottom menu, in the left menu, turn the **M** knob to select **Record**.
3. Select **Mode** in the bottom menu, select **OFF** in the right menu.
4. In the bottom menu, select **Storage** as **External**.
5. Select **Mode** in the bottom menu, select **Record** in the right menu.
6. Select **FrameSet** in the bottom menu, set **End frame** and **Interval** in the right menu. If you want to record wave to external infinitely, select **Infinity** in the right menu, the End frame will display “-”.
7. In the bottom menu, set **Refresh**.
8. In the bottom menu, select **Operate** as **Play**.

Connect external device to the computer, and *wave_record_0.bin* is the recorded file. Open the software, and do as follows to play back the waveform.

1. Choose Communications → Auto Player.
2. Transform recording waveform from machine.
3. Add the well transformed files.
4. Set play mode and time delay.
5. Click the green button on the left corner to begin playing back the waveform.

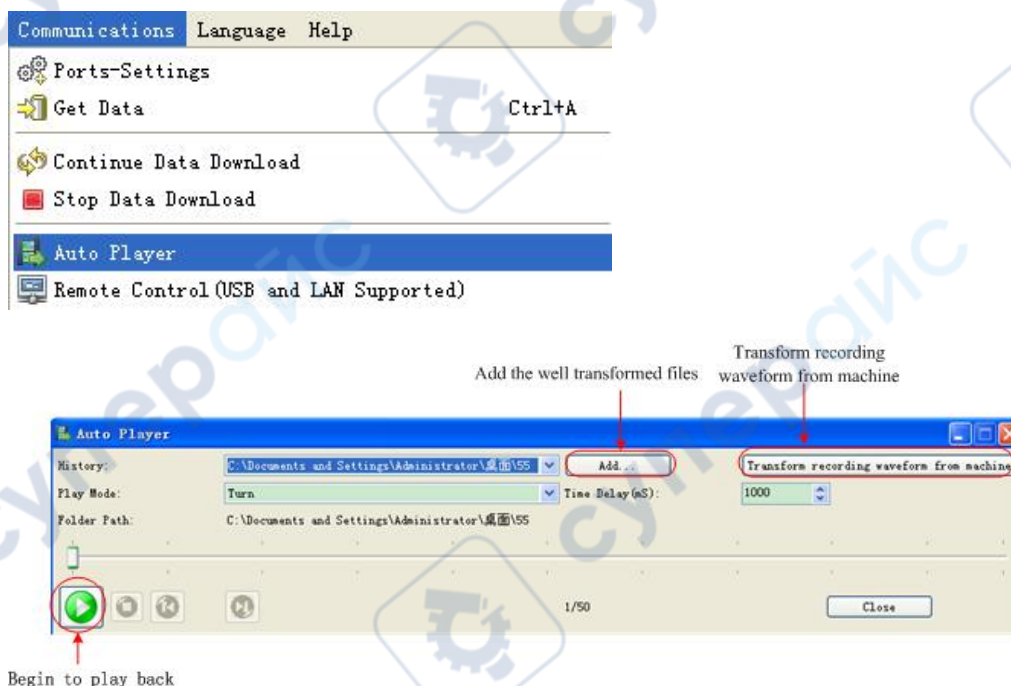


Figure 4- 19: Play back waveform by software

How to Clone and Recall a waveform

You can clone the waveform of one or both channels between two cursors, and save it in the internal memory or on a USB memory device. You can save four cloned waveforms in the instrument internal memory. The waveform files saved to a USB

memory device are saved with the extension ".ota".

If the optional Arbitrary Function Generator is available in your instrument, you can output the stored waveform from a file in the internal memory or in a USB memory device; and the waveform between two cursors can be output directly without save operation.

Clone Wave menu shows as follows:

Menu	Setting	Instruction	
Source	CH1	Clone the waveform of CH1.	
	CH2	Clone the waveform of CH2.	
	CH1&CH2 (Only for dual-channel AG)	Clone the waveform of CH1 and CH2.	
Line	a	Turn the M knob to move line a.	
	b	Turn the M knob to move line b.	
	ab	Two cursors are linked. Turn the M knob to move the pair of cursors.	
	x	Set the cursors to select the entire screen automatically.	
Clone (Generator is available)	Clone	Clone the waveform between two cursors, and output it through the generator.	
	AG Output (Only for dual-channel AG)	Out1 Out2	If the source is CH1 or CH2, you can select the output channel of the generator. If the source is CH1&CH2, the output channel is not selectable. Out1 outputs CH1, Out2 outputs CH2.
Save	Save	Save the waveform between two cursors.	
	Memory	Internal USB	Select the memory location.
	Output	(Generator is available and internal memory is selected) Output the waveform in the selected object on the left.	
	AG Output (Only for dual-channel AG)	Out1 Out2	(Generator is available and internal memory is selected) For the waveform in the selected object on the left: If the source is CH1 or CH2, you can select the output channel of the generator. If the source is CH1&CH2, the output channel is not selectable. Out1 outputs CH1, Out2 outputs CH2.

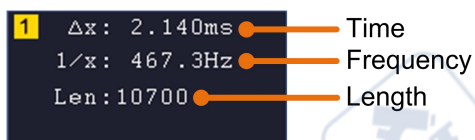
The following steps take XDS oscilloscope with dual-channel AG for instance.

To clone waveform and save to the internal/USB memory:



- (1) Push **Save** button.
- (2) Select **Type** in the bottom menu, in the left menu, turn the **M** knob to select

Clone.

- (3) Select **Source** in the bottom menu, select one channel (**CH1/CH2**) or two channels (**CH1&CH2**) in the right menu for Source.
- (4) Select **Line** in the bottom menu. If **a** or **b** is selected, turn the **M** knob to move the cursor. If **ab** is selected, turn the **M** knob to move the pair of cursors. If **x** is selected, the entire screen will be selected automatically. The waveform information is displayed at the left bottom corner of the screen.



Note: If "Out Of Limits" appears in the information or a message "Waveform points beyond the limit." appears on the screen, that means the length of the cloned waveform exceeds the limit. When the source is CH1 or CH2, the maximum length is 2M; When the source is CH1&CH2, the maximum length is 1M. Push the **Acquire** button, select **Length** in the bottom menu, and set the record length to a smaller value.

- (5) Select **Save** in the bottom menu.
 - **To save the waveform to internal memory**, select **Storage** in the right menu as **Internal**. Turn the **M** knob to select an object in the left menu, select **Save** in the right menu.
 - **To save the waveform onto a USB memory device**, insert a USB memory device into the port on the front panel. If the icon  appears on the top right of the screen, the USB memory device is installed successfully. If the USB memory device cannot be recognized, format the USB memory device according to the methods in "USB disk Requirements" on P68. Select **Storage** in the right menu as **External**. Select **Save** in the right menu. An input keyboard used to edit the file name will pop up. The name is default as current system date and time. Turn the **M** knob to select the keys, push the knob to input. Select the  key in the keyboard to confirm. The cloned waveform will be saved onto the USB memory device as a file with the ota suffix.

To output the cloned waveform in the internal memory through the generator:

(The generator is optional.)

- (1) Push **Save** button.
- (2) Select **Type** in the bottom menu, in the left menu, turn the **M** knob to select **Clone**.
- (3) Select **Save** in the bottom menu, select **Storage** in the right menu as **Internal**.
- (4) Turn the **M** knob to select an object in the left menu. If the source of the selected waveform is CH1 or CH2, select **AG Output** in the right menu and set the output channel of the generator. If the source is CH1&CH2, the output channel is not selectable.
- (5) Select **Output** in the right menu.

To output the cloned waveform in the USB memory device through the generator:

(The generator is optional.)

- (1) Push **AFG** (single-channel) or **CH1/2** (dual-channel) button.
For dual-channel, push **CH1/2** button to set the output channel of the generator.
- (2) Select **Arb** in the bottom menu, select **Others** in the right menu, and select **File Browse**.
- (3) select **Memory** in the right menu as **USB**. The instrument lists a directory of the folders and files on the USB memory device. Select a folder or file using the **M** knob to scroll up and down the list. To enter the current folder, select **Change Dir** in the right menu, select it again to return to the upper directory.
- (4) Select the desired ota file, select **Read** in the right menu.

To output the selected waveform through the generator directly:

(The generator is optional.)

- (1) Push **Save** button.
- (2) Select **Type** in the bottom menu, in the left menu, turn the **M** knob to select **Clone**.
- (3) Select **Source** in the bottom menu, select one channel (**CH1/CH2**) or two channels (**CH1&CH2**) in the right menu for Source.
- (4) Select **Line** in the bottom menu. Select the cursor and move it to select the desired waveform.
- (5) Select **Clone** in the bottom menu. If the source is CH1 or CH2, select **AG Output** in the right menu and set the output channel of the generator. If the source is CH1&CH2, the output channel is not selectable.
- (6) Select **Clone** in the right menu. The generator will output the waveform between two cursors.

Move the cursors by gestures (only for touchscreen)

About the gestures for moving cursors, you can refer to "*Other Operations Using Touchscreen*" on P23.

Data format description of OTA waveform file

If the source is CH1 or CH2, OTA file consists of two parts: the file header and the data. If the source is CH1&CH2, OTA file consists of three parts: file header, CH1data, and CH2 data. The file header represents the parameter of file data, which is expressed in "parameter name + value". Each parameter name is a case-sensitive string of 4 bytes. The parameter value is at least 4 bytes.

1.Format description of the file header:

- 1) **HEAD**

Parameter name	Meaning	Value	Comment
HEAD	Header size	4 bytes int	

2) TYPE

Parameter name	Meaning	Value	Comment
TYPE	Model	12 bytes char	

3) BYTE

Parameter name	Meaning	Value	Comment
BYTE	Data length in bit	4 bytes int	

4) SIZE

Parameter name	Meaning	Value	Comment
SIZE	File size	4 bytes int	Used to check the file integrity

5) VOLT

Parameter name	Meaning	Value	Comment
VOLT	Voltage division, divided by 400 is ADC resolution. (When the source is CH1&CH2, it is CH1 voltage division.)	4 bytes float	The value indicates voltage (the unit is mV), such as 200 mV.

6) SAMP

Parameter name	Meaning	Value	Comment
SAMP	Sample rate	4 bytes float	The unit is Sa/s.

7) ADCB

Parameter name	Meaning	Value	Comment
ADCB	ADC bit, ADC resolution	4 bytes int	8-bit or 12-bit

8) CHAN

Parameter name	Meaning	Value	Comment
CHAN	Number of channels	4 bytes int	1 or 2

9) VOL2

Parameter name	Meaning	Value	Comment
VOL2	Voltage division, divided by 400 is ADC resolution. (When the source is CH1&CH2, it is CH2 voltage division.)	4 bytes float	The value indicates voltage (the unit is mV), such as 200 mV.

2.Data

The data type is signed integer. You can determine the data type (**char**, **short int** or **int**) based on the BYTE parameter. The valid range is determined by the ADCB

parameter, e.g. the valid range for 8-bit ADC is -127 to +127.

How to Implement the Auxiliary System Function Setting

●Config

Push the **Utility** button, select **Function** in the bottom menu, select **Configure** in the left menu.

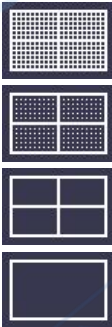
The description of **Configure Menu** is shown as the follows:

Function Menu	Setting	Description
Language		Choose the display language of the operating system.
Set Time	Display <input type="checkbox"/> ON <input type="checkbox"/> OFF	On/Off the date display.
	Hour Min	Setting Hour/Minute.
	Day Month	Setting Date/Month.
	Year	Setting Year.
KeyLock		Lock all keys. Unlock method: push Trigger Menu button in trigger control area, then push Force button, repeat 3 times.
About		Version number and serial number showing.

●Display

Push the **Utility** button, select **Function** in the bottom menu, select **Display** in the left menu.

The description of **Display Menu** is shown as the follows:

Function Menu	Setting	Description
BackLight	0% - 100%	Turn the M knob to adjust the backlight.
Graticule		Select the grid type.
Battery	<input type="checkbox"/> ON <input type="checkbox"/> OFF	Turn on or off the battery display.
Menu Time	OFF, 5s - 30s	Set the disappear time of menu.

●Adjust

Push the **Utility** button, select **Function** in the bottom menu, select **Adjust** in the left menu.

The description of **Adjust Menu** is shown as the follows:

Function Menu	Description
---------------	-------------

Self Cal	Carry out the self-calibration procedure.
Default	Call out the factory settings.
ProbeCh.	Check whether probe attenuation is good.

Do Self Cal (Self-Calibration)

The self-calibration procedure can improve the accuracy of the oscilloscope under the ambient temperature to the greatest extent. If the change of the ambient temperature is up to or exceeds 5°C, the self-calibration procedure should be executed to obtain the highest level of accuracy.

Before executing the self-calibration procedure, disconnect all probes or wires from the input connector. Push the **Utility** button, select **Function** in the bottom menu, the function menu will display at the left, select **Adjust**. If everything is ready, select **Self Cal** in the bottom menu to enter the self-calibration procedure of the instrument.

Probe checking

To check whether probe attenuation is good. The results contain three circumstances: Overflow compensation, Good compensation, Inadequate compensation. According to the checking result, users can adjust probe attenuation to the best. Operation steps are as follows:

1. Connect the probe to CH1, adjust the probe attenuation to the maximum.
2. Push the **Utility** button, select **Function** in the bottom menu, select **Adjust** in the left menu.
3. Select **ProbeCh.** in the bottom menu, tips about probe checking shows on the screen.
4. Select **ProbeCh.** again to begin probe checking and the checking result will occur after 3s; push any other key to quit.

● Pass/Fail

The **Pass/Fail** function monitors changes of signals and output pass or fail signals by comparing the input signal that is within the pre-defined mask.

Push the **Utility** button, select **Function** in the bottom menu, select **Pass/fail** in the left menu.

Function Menu	Setting	Description
operate	Enable	Control enable switch.
	Operate	Control operate switch.
Output	Pass	Signal tested corresponds with the rule.
	Fail	Signal tested not correspond with the rule.
	Beep	Beep when it satisfies the rule.
	Stop	Stop once satisfying the rule.
	Info	Control the display status of info frame.

Rule	Source	Select source CH1, CH2 or Math.
	Horizontal	Change the Horizontal tolerance value by turning the M knob.
	Vertical	Change the Vertical tolerance value by turning the M knob.
	Create	Use the rule set as testing rule.
SaveRule	Number	Select any one from Rule1 - Rule8 as your rule name.
	Save	Select Save to save the rule.
	Load	Load some rule as the testing rule.

The description of **Pass/fail Menu** is shown as the follows:

Pass/Fail test:

Detect whether the input signal is within the limits of the rule, if it exceeds limits of the rule, it is "Fail"; otherwise it is "Pass". Also it can output fail or pass signal by built-in and configurable output port. To run the test, read the following steps:

1. Push the **Utility** button, select **Function** in the bottom menu, select **Pass/fail** in the left menu.
2. **Enable switch on:** Select **Operate** in the bottom menu, select **Enable** in the right menu as **ON**.
3. **Create rule:** Select **Rule** in the bottom menu. Select **Source** in the right menu, select the source in the left menu. Set **Horizontal** tolerance and **Vertical** tolerance in the right menu. Select **Create** in the right menu to create the rule.
4. **Set output type:** Select **Output** in the bottom menu to enter output option setting. Choose any one or two of the options "**Pass**", "**Fail**" or "**Beep**". "**Pass**" and "**Fail**" are mutually exclusive options, which could not be chosen simultaneously. "**Stop**" means stop once the condition satisfies your setting.
5. **Begin to test:** Select **Operate** in the bottom menu, select **Operate** in the right menu as **Start**, the test will begin.
6. **Save rule:** Select **SaveRule** in the bottom menu. Select the save location in the left menu, and then select **Save** in the right menu to save the rules, which could be called up at once when need. Select **Load** to call up the rule saved.

Note:

1. When Pass/Fail is ON, if XY or FFT is ready to run, then Pass/Fail will be closed; under the mode of XY or FFT, Pass/Fail is unable.
2. Under the mode of Factory, Auto Scale and Auto Set, Pass/Fail will be closed.
3. When no save setting left in the rule save, tip will be given to show "NO RULE SAVED".
4. Under the status of stop, data comparing will stop, and when it goes on running, the number of Pass/Fail will increase from the former number, not from zero.
5. When the waveform playback mode is on, Pass/Fail is used to test the played-back waveform specially.

● **Output**

Push the **Utility** button, select **Function** in the bottom menu, select **Output** in the left menu.

Output menu item in the bottom menu sets the output type of Trig Out(P/F) port in Figure 3- 3 Rear Panel on P6. In the bottom menu, select **Output**. The description of **Output menu** is shown as the follows:

Function Menu	Setting	Description
Type	Trig level	Output trig signal synchronously.
	Pass/fail	Output High Level when Pass , and Low Level when Fail.
	AG Output	CH2 Output of dual-channel waveform generator (optional).

Video menu item in the bottom menu sets the output port of video. In the bottom menu, select **Video**. The description of **Video menu** is shown as the follows:

Function Menu	Setting	Description
Video	OFF	Turn off video output.
	VGA	Connect the VGA or AV port to an external monitor or projector. Select the port in this menu, the oscilloscope display can be shown on an external monitor or projector.
	AV	

Device and Print Setup menu items set the print output, refer to "How to Print the Screen Image" on page 97.

- **LAN Set**

Using the LAN port or Wi-Fi, the oscilloscope can be connected with a computer. The oscilloscope also supports communications with Android based smart device via Wi-Fi. Refer to "Communication with PC" on page 115 and "Communication with Android Device via Wi-Fi (Optional)" on page 123 for the operation steps.

- **Update**

Use the front-panel USB port to update your instrument firmware using a USB memory device. Refer to "How to Update your Instrument Firmware" on page 83.

- **DAQ**


You can use the multimeter data recorder to record the measurements when measuring current/voltage by multimeter (optional). Refer to "Multimeter Recorder" on page 112.

- **FRA (Frequency Response Analysis)**

If there is a built-in arbitrary function generator (optional), you can use the frequency response analysis. Refer to "Frequency Response Analysis" on page 106.

How to Update your Instrument Firmware

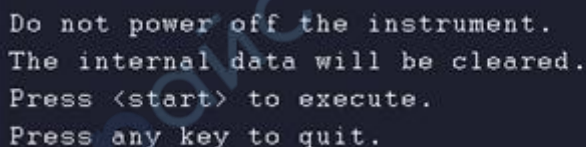
Use the front-panel USB port to update your instrument firmware using a USB memory device.

USB memory device requirements: Insert a USB memory device into the USB port on the front panel. If the icon  appears on the top right of the screen, the USB memory device is installed successfully. If the USB memory device cannot be detected, format the USB memory device according to the methods in "USB disk Requirements" on P68.

Caution: Updating your instrument firmware is a sensitive operation, to prevent damage to the instrument, do not power off the instrument or remove the USB memory device during the update process.

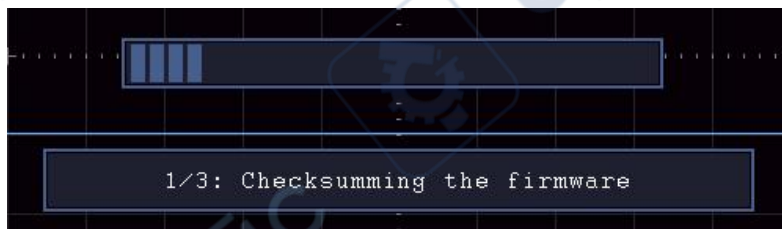
To update your instrument firmware, do the following:

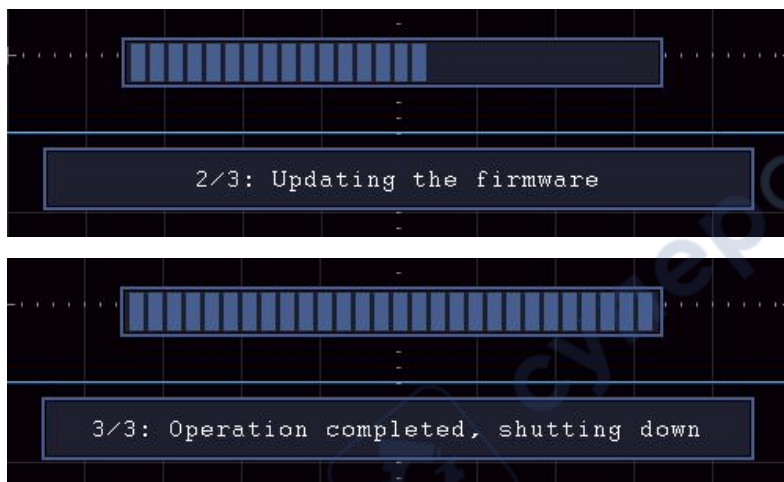
1. Push the **Utility** button, select **Function** in the bottom menu, select **Configure** in the left menu, select **About** in the bottom menu. View the model and the currently installed firmware version.
2. From a PC, visit the website and check if the website offers a newer firmware version. Download the firmware file. The file name must be *.update. The file name can be up to 15 characters long (including the suffix). Copy the firmware file onto your USB memory device.
3. Insert the USB memory device into the front-panel USB port on your instrument.
4. Push the **Utility** button, select **Function** in the bottom menu, select **Update** in the left menu.
5. Select **Open** in the bottom menu, the instrument lists a directory of the folders on the USB memory device. Turn the **M** knob to select a folder, select **Open** in the bottom menu to enter the folder. Navigate to the folder where the firmware file is, and select the file with the .update suffix.
6. In the bottom menu, select **Open**, the messages below will be shown.



```
Do not power off the instrument.  
The internal data will be cleared.  
Press <start> to execute.  
Press any key to quit.
```

7. In the bottom menu, select **Start** again, the interfaces below will be displayed in sequence. The update process will take up to three minutes. After completion, the instrument will be shut down automatically.





8. Long press the  button to power on the instrument.

How to Measure Automatically

Push the **Measure** button to display the menu for the settings of the Automatic Measurements. At most 8 types of measurements could be displayed on the bottom left of the screen.

The oscilloscopes provide 38 parameters for auto measurement, including Period, Frequency, Mean, PK-PK, RMS, Max, Min, Top, Base, Amplitude, Overshoot, Preshoot, Rise Time, Fall Time, +PulseWidth, -PulseWidth, +Duty Cycle, -Duty Cycle, Delay A→B Φ , Delay A→B Ψ , Cycle RMS, Cursor RMS, Screen Duty, FRR, FRF, FFR, FFF, LRR, LRF, LFR, LFF, Phase, +PulseCount, -PulseCount, RiseEdgeCnt, FallEdgeCnt, Area, and Cycle Area.

The "Automatic Measurements" menu is described as the following table:

	Function Menu	Setting	Description
Add	Meas Type (left menu)		Select the measure types.
	Source	CH1 CH2	Select the source.
	Add		Add the selected measure types (shown at the left bottom, you could only add 8 types at most).
Remove	Meas Type (left menu)		Select the types need to be deleted.
	Remove		Remove the chosen measure type.
	Remove All		Remove all the measures.
Show CH1	ON OFF		Show all the measures of CH1 on the screen Hide the window of CH1 measures.
Show CH2	ON OFF		Show all the measures of CH2 on the screen Hide the window of CH2 measures.

Configure	Gating	Screen Cursor	Select "Screen" or "Cursor" to set the cursor range.
	Statistics	ON OFF	select "ON" or "OFF" for measurement value statistics.
	Statistics Sel	Extremum Difference	When the statistics function is turned on, select "Extreme Value", the current value, average value, maximum value, and minimum value will be displayed at the bottom of the screen; select "Difference", the current value, average value, standard deviation, and number of samples will be displayed at the bottom of the screen.
	Std Dev Samples		The number of standard deviation samples, the number of samples to calculate the standard deviation(Range:0-999).
	Reset		Restart statistics on statistics.

Measure

Only if the waveform channel is in the ON state, the measurement can be performed. The automatic measurement can not be performed in the following situation: 1) On the saved waveform. 2) On the Dual Wfm Math waveform. 3) On the Video trigger mode.

On the Scan format, period and frequency can not be measured.

Measure the period, the frequency of the CH1, following the steps below:

1. Push the **Measure** button to show the automatic measurement function menu.
2. Select **Add** in the bottom menu.
3. In the right menu, select **CH1** in the **Source** menu item.
4. In the left Type menu, turn the **M** knob to select **Period**.
5. In the right menu, select **Add**. The period type is added.
6. In the left Type menu, turn the **M** knob to select **Frequency**.
7. In the right menu, select **Add**. The frequency type is added.

The measured value will be displayed at the bottom left of the screen automatically (see *Figure 4-20*).

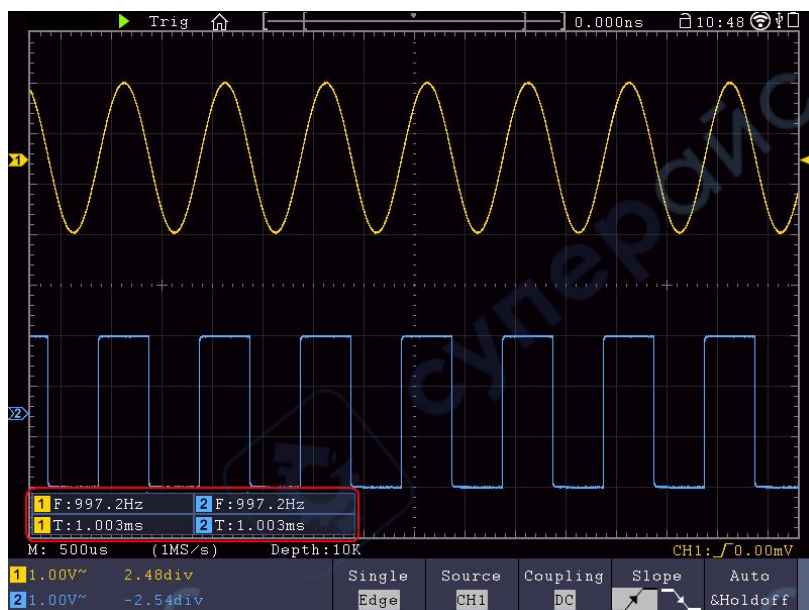


Figure 4-20 Automatic measurement

The automatic measurement of voltage parameters

The oscilloscopes provide automatic voltage measurements including Mean, PK-PK, RMS, Max, Min, Vtop, Vbase, Vamp, OverShoot, PreShoot, Cycle RMS, and Cursor RMS. *Figure 4-21* below shows a pulse with some of the voltage measurement points.

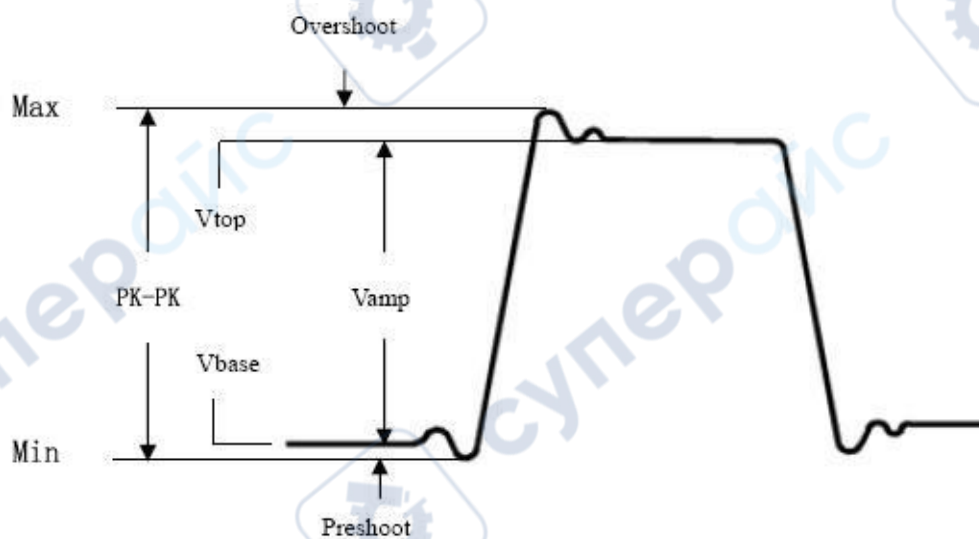


Figure 4-21

Mean: The arithmetic mean over the entire waveform.

PK-PK: Peak-to-Peak Voltage.

RMS: The true Root Mean Square voltage over the entire waveform.

Max: The maximum amplitude. The most positive peak voltage measured over the entire waveform.

Min: The minimum amplitude. The most negative peak voltage measured over the entire waveform.

Top: Voltage of the waveform's flat top, useful for square/pulse waveforms.

Base: Voltage of the waveform's flat base, useful for square/pulse waveforms.

Amplitude: Voltage between V_{top} and V_{base} of a waveform.

Overshoot: Defined as $(V_{max} - V_{top}) / V_{amp}$, useful for square and pulse waveforms.

Preshoot: Defined as $(V_{min} - V_{base}) / V_{amp}$, useful for square and pulse waveforms.

Cycle RMS: The true Root Mean Square voltage over the first entire period of the waveform.

Cursor RMS: The true Root Mean Square voltage over the range of two cursors.

The automatic measurement of time parameters

The oscilloscopes provide time parameters auto-measurements include Period, Frequency, Rise Time, Fall Time, +D width, -D width, +Duty, -Duty, Delay $A \rightarrow B \Psi$, Delay $A \rightarrow B \Phi$, and Duty cycle.

Figure 4-22 shows a pulse with some of the time measurement points.

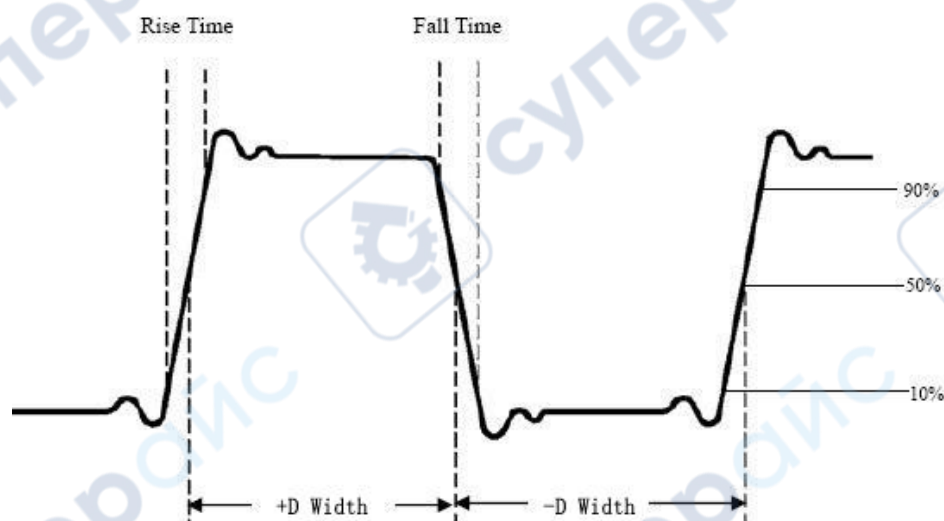


Figure 4-22

Rise Time: Time that the leading edge of the first pulse in the waveform takes to rise from 10% to 90% of its amplitude.

Fall Time: Time that the falling edge of the first pulse in the waveform takes to fall from 90% to 10% of its amplitude.

+Duty width: The width of the first positive pulse in 50% amplitude points.

-Duty width: The width of the first negative pulse in the 50% amplitude points.

+Duty: +Duty Cycle, defined as $+Width/Period$.

-Duty: -Duty Cycle, defined as $-Width/Period$.

Delay $A \rightarrow B \Psi$: The delay between the two channels at the rising edge.

Delay A→B \Downarrow : The delay between the two channels at the falling edge.

Screen Duty: Defines as (the width of the positive pulse)/(Entire period)

Phase: Compare the rising edge of CH1 and CH2, calculate phase difference of two channels.

Phase difference=(Delay between channels at the rising edge÷Period)×360° .

Note for the following delay measurements:

Source A and Source B can be set in the automatic measurement function menu.

FRR: Time between Source A first rising edge and Source B first rising edge.

FRF: Time between Source A first rising edge and Source B first falling edge.

FFR: Time between Source A first falling edge and Source B first rising edge.

FFF: Time between Source A first falling edge and Source B first falling edge.


LRR: Time between Source A first rising edge and Source B last rising edge.


LRF: Time between Source A first rising edge and Source B last falling edge.


LFR: Time between Source A first falling edge and Source B last rising edge.


LFF: Time between Source A first falling edge and Source B last falling edge.


Other measurements


+PulseCount : The number of positive pulses that rise above the mid reference crossing in the waveform.

-PulseCount : The number of negative pulses that fall below the mid reference crossing in the waveform.

RiseEdgeCnt : The number of positive transitions from the low reference value to the high reference value in the waveform.

FallEdgeCnt : The number of negative transitions from the high reference value to the low reference value in the waveform.

Area : The area of the whole waveform within the screen and the unit is voltage-second. The area measured above the zero reference (namely the vertical offset) is positive; the area measured below the zero reference is negative. The area measured is the algebraic sum of the area of the whole waveform within the screen.

Cycle Area : The area of the first period of waveform on the screen and the unit is voltage-second. The area above the zero reference (namely the vertical offset) is positive and the area below the zero reference is negative. The area measured is the algebraic sum of the area of the whole period waveform.

Note: When the waveform on the screen is less than a period, the period area measured is 0.

Customize an Automatic Measurement

You can customize automatic measurements by using gating and statistics.

Gating

- Press the **Measure** button, and the automatic measurement function menu is displayed at the bottom of the screen;
- Press the **Set** softkey at the bottom of the screen, the setting menu appears on the right side of the screen;
- Select the **Gating** menu. There are two menus: **Screen** and **Cursor** under the range. Click the **Screen** and then click the **Cursor**, or press the right **Screen** menu button twice to set the cursor range.

Statistics

Select **Statistics**, you can choose **On** or **Off** to enable or disable statistics on the measurement value.

Statistical selection

Statistics and display the current value, average value, minimum value (or number of samples) and maximum value (standard deviation) of up to 8 measurement results opened last.

When the statistics function is turned on, select "**Extreme Value**", the current value, average value, maximum value, and minimum value will be displayed at the bottom of the screen; select "**Difference**", the current value, average value, standard deviation, and number of samples will be displayed at the bottom of the screen.

The number of standard deviation samples: The number of standard deviation samples, the number of samples used to calculate the standard deviation.

Statistics **Reset:** Restart statistics on statistics.

How to Measure with Cursors

Push the **Cursor** button to turn cursors on and display the cursor menu. Push it again to turn cursors off.

The Cursor Measurement for normal mode:

The description of the **cursor menu** is shown as the following table:

Function Menu	Setting	Description
Type	Voltage	Display the voltage measurement cursor and menu.
	Time	Display the time measurement cursor and menu.
	Time&Voltage	Display the time and voltage measurement cursor and menu.
	AutoCursr	The horizontal cursors are set as the intersections of the vertical cursors and the waveform.
Line Type (Time&Voltage type)	Time	Makes the vertical cursors active.
	Voltage	Makes the horizontal cursors active.

Window (Wave zoom mode)	Main Extension	Measure in the main window. Measure in the extension window.
Line	a b ab	Turn the M knob to move line a. Turn the M knob to move line b. Two cursors are linked. Turn the M knob to move the pair of cursors.
Source	CH1 CH2	Display the channel to which the cursor measurement will be applied.

Perform the following operation steps for the time and voltage cursor measurement of the channel CH1:

1. Push **Cursor** to display the cursor menu.
2. In the bottom menu, select **Source** as **CH1**.
3. Select the first menu item in the bottom menu, the **Type** menu will display at the right of the screen. In the right menu, select **Time&Voltage** for Type, two blue dotted lines displayed along the horizontal direction of the screen, two blue dotted lines displayed along the vertical direction of the screen. Cursor measure window at the left bottom of the screen shows the cursor readout.
4. In the bottom menu, select **Line Type** as **Time** to make the vertical cursors active. If the **Line** in the bottom menu is select as **a**, turn the **M** knob to move line a to the right or left. If **b** is selected, turn the **M** knob to move line b.
5. In the bottom menu, select **Line Type** as **Voltage** to make the horizontal cursors active. Select **Line** in the bottom menu as **a** or **b**, turn the **M** knob to move it.
6. Push the **Horizontal HOR** button to enter wave zoom mode. In the bottom cursor menu, select **Window** as **Main** or **Extension** to make the cursors shown in the main window or zoom window.

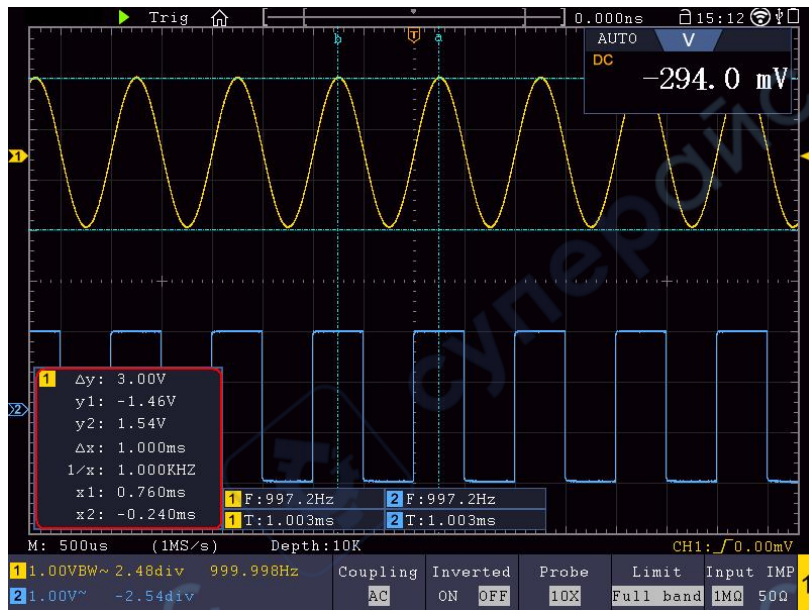
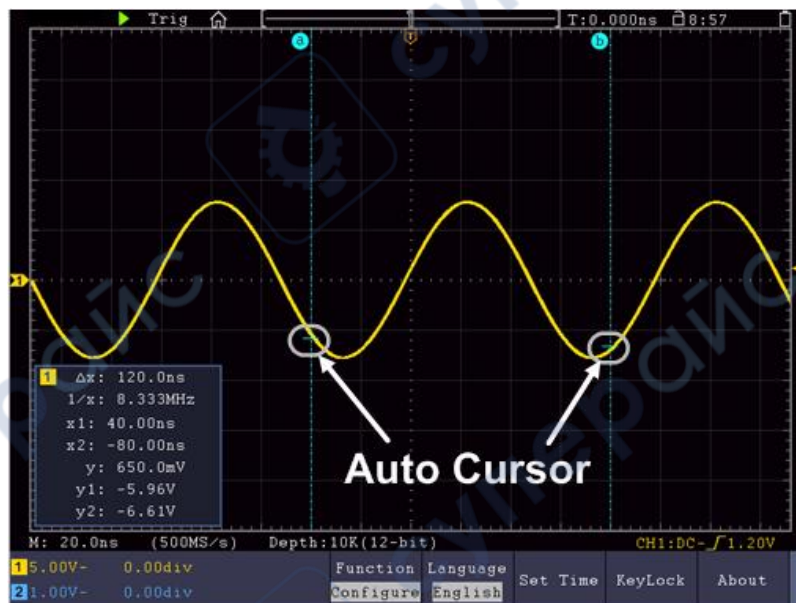


Figure 4-23 Time&Voltage Cursor Measurement

Auto Cursor

For the AutoCursr type, the horizontal cursors are set as the intersections of the vertical cursors and the waveform.



Move the cursors by gestures

About the gestures for moving cursors, see "*Other Operations Using Touchscreen*" on P23.

The Cursor Measurement for FFT mode

In FFT mode, push the **Cursor** button to turn cursors on and display the cursor menu.

The description of the **cursor menu** in FFT mode is shown as the following table:

Function Menu	Setting	Description
Type	Vamp (or Phase)	Display the Vamp (or Phase) measurement cursor and menu.
	Freq	Display the Freq measurement cursor and menu.
	Freq&Vamp (or Freq&Phase)	Display the corresponding measurement cursor and menu.
	AutoCursr	The horizontal cursors are set as the intersections of the vertical cursors and the waveform.
Line Type (Freq&Vamp or Freq&Phase type)	Freq	Makes the vertical cursors active.
	Vamp (or Phase)	Makes the horizontal cursors active.
Window (Wave zoom mode)	Main	Measure in the main window.
	Extension	Measure in the FFT extension window.
Line	a	Turn the M knob to move line a.
	b	Turn the M knob to move line b.
	ab	Two cursors are linked. Turn the M knob to move the pair of cursors.
Source	Math FFT	Display the channel to which the cursor measurement will be applied.

Perform the following operation steps for the amplitude and frequency cursor measurement of math FFT:






1. Press the **Math** button to display the math menu in the bottom. Select **FFT**. In the right menu, select **Format**. In the left menu, turn the **M** knob to select amplitude unit (**V RMS** or **Decibels**).
2. Push **Cursor** to display the cursor menu.
3. In the bottom menu, select **Window** as **Extension**.
4. Select the first menu item in the bottom menu, the **Type** menu will display at the right of the screen. In the right menu, select **Freq&Vamp** for **Type**, two blue dotted lines displayed along the horizontal direction of the screen, two blue dotted lines displayed along the vertical direction of the screen. Cursor measure window at the left bottom of the screen shows the cursor readout.
5. In the bottom menu, select **Line Type** as **Freq** to make the vertical cursors active. If the **Line** in the bottom menu is select as **a**, turn the **M** knob to move line a to the right or left. If **b** is selected, turn the **M** knob to move line b.
6. In the bottom menu, select **Line Type** as **Vamp** to make the horizontal cursors active. Select **Line** in the bottom menu as **a** or **b**, turn the **M** knob to move it.

7. In the bottom cursor menu, you can select **Window** as **Main** to make the cursors shown in the main window.



How to Use Autoscale

This is a very useful function for first time users to carry out a simple and quick test on the input signal. The function is applied to follow-up signals automatically even if the signals change at any time. Autoscale enables the instrument to set up trigger mode, voltage division and time scale automatically according to the type, amplitude and frequency of the signals.

The menu is as follows:

Function Menu	Setting	Instruction
Autoscale	ON	Turn on Autoscale.
	OFF	Turn off Autoscale.
Mode		Follow-up and adjust both vertical and horizontal settings.
		Follow-up and only adjust horizontal scale.
		Follow-up and only adjust vertical scale.
Wave		Show Multi-period waveforms.
		Only show one or two periods.

If you want to measure the two-channel signal, you can do as the follows:

1. Push the **Autoscale** button, the function menu will appear.
2. In the bottom menu, select **ON** in the **Autoscale** menu item.
3. In the bottom menu, Select **Mode**. In the right menu, select .
4. In the bottom menu, Select **Wave**. In the right menu, select .

Then the wave is displayed in the screen, shown as *Figure 4-24*.

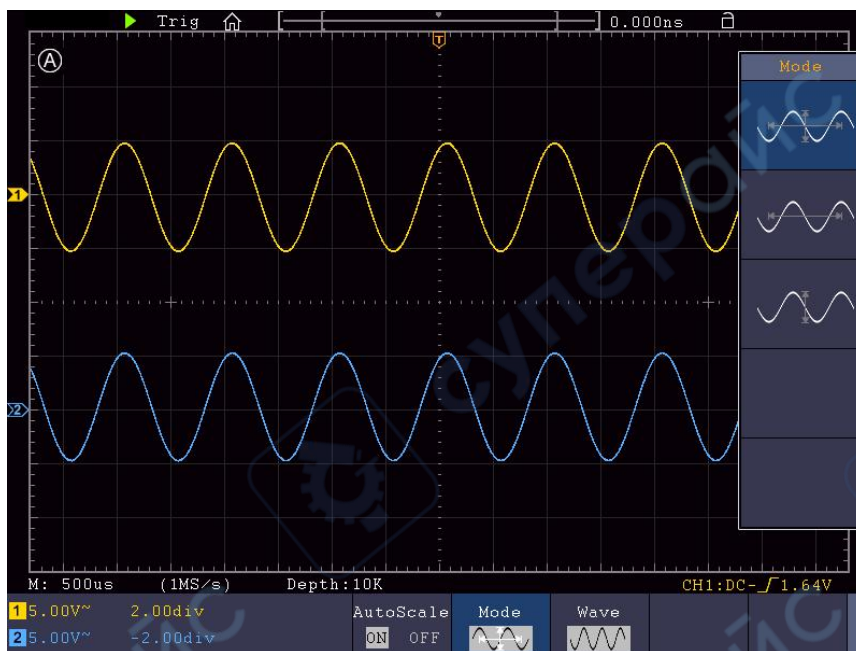


Figure 4-24 Autoscale Horizontal-Vertical multi-period waveforms

Note:

1. Entering into Autoscale function and the symbol **(A)** will be flickering on the top left of the screen.
2. In the mode of Autoscale, the oscilloscope can self-estimate Trigger Mode (Edge, Video). At this point, the trigger menu is not available.
3. At the mode of XY and STOP status, when entering into Autoscale, DSO switches to YT mode and AUTO triggering.
4. At the mode of Autoscale, DSO is always set as DC coupling with AUTO triggering.
5. At the mode of Autoscale, if adjust the vertical position, voltage division, trigger level or time scale of CH1 or CH2, the oscilloscope will turn off Autoscale function. To back to Autoscale, Push **Autoset**.
6. Turn off the submenu at the Autoscale menu, the Autoscale is off and turn on the submenu still enters into the function.
7. When video triggering, the horizontal time scale is 50us. If one channel is showing edge signal, the other channel is showing video one, the time scale refers to 50us as video one as standard.
8. While the Autoscale is working, the settings below will be made forcibly:
The DSO will switch from the wave zoom mode to the normal mode.

How to Use Built-in Help

1. Push **Help** button, the catalog will display in the screen.
2. In the bottom menu, press **Prev Page** or **Next Page** to choose help topic, or just turn the **M** knob to choose.
3. Press **OK** to view the details about the topic, or just push the M knob.
4. Press **Quit** to exit the help, or just do other operations.

How to Use Executive Buttons

Executive Buttons include **Autoset**, **Run/Stop**, **Single**, **Copy**.

Autoset

It's a very useful and quick way to apply a set of pre-set functions to the incoming signal, and display the best possible viewing waveform of the signal and also works out some measurements for user as well.

The details of functions applied to the signal when using **Autoset** are shown as the following table:

Function Items	Setting
Vertical Coupling	Current
Channel Coupling	Current
Vertical Scale	Adjust to the proper division.
Bandwidth	Full
Horizontal Level	Middle or ± 2 div
Horizontal Sale	Adjust to the proper division
Trigger Type	Slope or Video
Trigger Source	CH1 or CH2
Trigger Coupling	DC
Trigger Slope	Current
Trigger Level	3/5 of the waveform
Trigger Mode	Auto
Display Format	YT
Force	Stop
Help	Exit
Pass/Fail	Off
Inverted	Off
Zoom Mode	Exit

Judge waveform type by Autoset

Five kinds of types: Sine, Square, video signal, DC level, Unknown signal.

Menu as follow:

Sine: (Multi-period, Single-period, FFT, Cancel Autoset)



Square: (Multi-period, Single-period, Rising Edge, Falling Edge, Cancel Autoset)



Video signal:

Type	Odd	Even	Line NO.	Cancel
line fiel			1	Autoset

DC level, Unknown signal:

Cancel
Autoset

Description for some icons:

- Multi-period: To display multiple periods.
- Single-period: To display single period.
- FFT: Switch to FFT mode.
- Rising Edge: Display the rising edge of square waveform.
- Falling Edge: Display the falling edge of square waveform.
- Cancel Autoset: Go back to display the upper menu and waveform information.

Note: The Autoset function requires that the frequency of signal should be no lower than 20Hz, and the amplitude should be no less than 5mv. Otherwise, the Autoset function may be invalid.

Run/Stop: Enable or disable sampling on input signals.

Notice: When there is no sampling at STOP state, the vertical division and the horizontal time base of the waveform still can be adjusted within a certain range, in other words, the signal can be expanded in the horizontal or vertical direction.

When the horizontal time base is $\leq 50\text{ms}$, the horizontal time base can be expanded for 4 divisions downwards.

Single: Push this button you can set the trigger mode as single directly, so when trigger occurs, acquire one waveform then stop.

Copy: You can save the waveform by just pushing the **Copy** panel button in any user interface. The source wave and the storage location are according to the settings of the **Save** function menu when the Type is **Wave**. For more details, please see "Save Function Menu" on P65.

How to Print the Screen Image

To print an image of what appears on the oscilloscope screen, do as the follows:

- (1) Connect the printer to the **USB Device port** on the rear panel of the oscilloscope.
Note: The USB Device port supports PictBridge compatible printers.
- (2) Push the **Utility** button, select **Function** in the bottom menu, select **Output** in the left menu.
- (3) In the bottom menu, select **Device** as **PICT**. (When **PC** is selected, you can get

an image by Oscilloscope software.)

- (4) In the bottom menu, select **Print Setup**. In the right menu, set up print parameters. The **On** selection of **Ink Saver** will print out a copy with a white background.
- (5) Once you have connected a printer to your oscilloscope and set up print parameters, you can print current screen images with a single push of the **Print** button on the front panel.

5. Use the Arbitrary Function Generator (Optional)

The oscilloscope contains an integrated arbitrary function generator (25 MHz, dual-channel or single-channel is optional). The function generator provides 4 basic waveforms (sine, square, ramp, and pulse) and 46 built-in arbitrary waveforms (Noise, Exponential rise, Exponential fall, Sin(x)/x, Staircase, etc.). You can create a user-definable waveform and save it to internal storage or USB device.

Output Connection

Push the **Utility** button, select **Function** in the bottom menu, select **Output** in the left menu. In the bottom menu, select **Output**, in the right menu, select **AG Output**.

Single-channel:

Connect the BNC cable to the port marked **Out** in the back of the oscilloscope.

Dual-channel:

Connect the BNC cable to the port marked **Out 1** or **Out 2** in the back of the oscilloscope.

Out 1 is the output of CH1, **Out 2** is the output of CH2, also can be used as the port of trigger signal output & Pass/Fail output.



Figure 5- 1 Generator Output Ports (Dual-channel)

To see the output of the generator, connect the other end of the BNC cable to one of the input channels on the front of the oscilloscope.

To Set Channels

Single-channel:

Push **Out** to turn on/off the channel output. The indicator will be lighted when the corresponding channel is tuned on.

Dual-channel:

- **To Switch Channels in Menu Settings**

Push **CH1/2** button to switch between **CH1** menu, **CH2** menu, and **Channel Copy** menu.

● To Turn On/Off Output of Channels

Push **Out 1** or **Out 2** to turn on/off output of the corresponding channel. The indicator will be lighted when the corresponding channel is tuned on.

● Channel Copy menu

Push **CH1/2** button to switch to **Channel Copy** menu.

CH2 To CH1	CH1 To CH2	Freq Lock On	Ampl Lock On	Align Phase
---------------	---------------	-----------------	-----------------	----------------

Copy Channel

Select **CH2 To CH1** in the bottom menu to copy parameters of CH2 to CH1.

Select **CH1 To CH2** in the bottom menu to copy parameters of CH1 to CH2.

Frequency Lock

Select **Freq Lock** in the bottom menu as **On**, the frequency of the two channels can be adjusted synchronously.

Amplitude Lock

Select **Ampl Lock** in the bottom menu as **On**, the amplitude of the two channels can be adjusted synchronously.

Align Phase

Select **Align Phase** in the bottom menu to align the initial phase of two channel signals.

To Set Signals

- (1) Push **AFG** (single-channel) or **CH1/2** (dual-channel) button to show the bottom menu of generator.
- (2) Select the desired waveform in the bottom menu, the corresponding menu is displayed on the right.
- (3) The parameters can be set in the right menu.

To Output Sine Signals



The parameters of Sine waveform in the right menu are: **Frequency/Period**, **Start Phase**, **Amplitude/High Level**, **Offset/Low Level**.

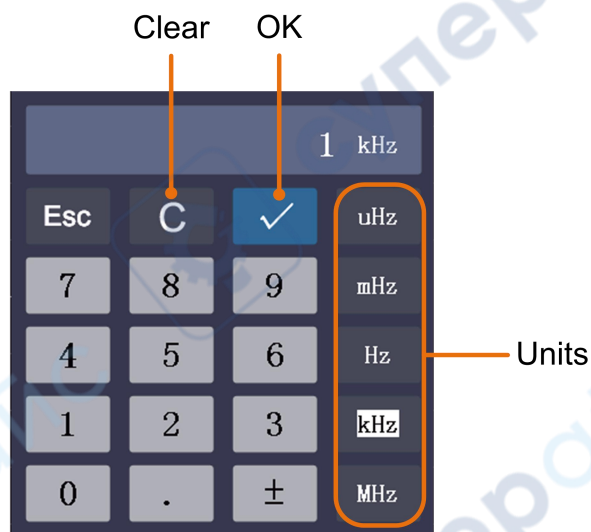
To Set the Frequency

Select **Frequency** in the right menu (if **Frequency** is not displayed, select **Period** and push it again to switch to **Frequency**). Set the parameter in the right menu, see below.

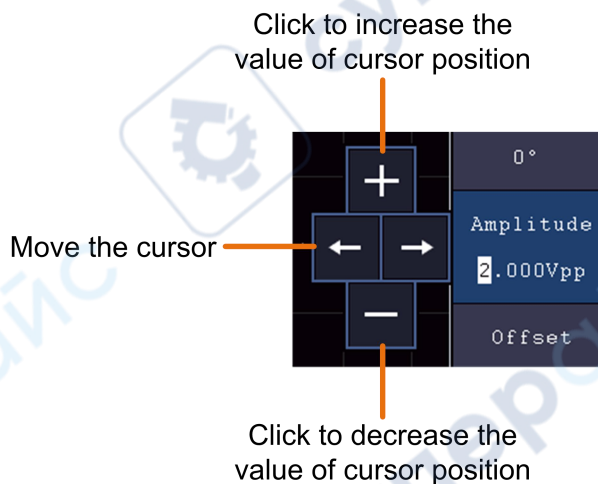
Three methods to change the chosen parameter:

5. Use the Arbitrary Function Generator (Optional)

- Turn the **M** knob to change the value of cursor position. Press  /  direction key to move the cursor.
- Use the **input keyboard**: Push the **M** knob, an input keyboard will pop up. Turn the **M** knob to move between the keys. Push the **M** knob to input the chosen key.



- Use the **touchscreen** (Touchscreen is optional):



To Set the Period

Select **Period** in the right menu (if **Period** is not displayed, select **Frequency** and select it again to switch to **Period**). Set the parameter in the right menu.

To Set the Start Phase

Select **StartPhase** in the right menu. Set the parameter in the right menu.

To Set the Amplitude

Select **Amplitude** in the right menu (if **Amplitude** is not displayed, select **High Level** and select it again to switch to **Amplitude**). Set the parameter in the right menu.

To Set the Offset

Select **Offset** in the right menu (if **Offset** is not displayed, select **Low Level** and select it again to switch to **Offset**). Set the parameter in the right menu.

To Set the High Level

Select **High Level** in the right menu (if **High Level** is not displayed, select **Amplitude** and select it again to switch to **High Level**). Set the parameter in the right menu.

To Set the Low Level

Select **Low Level** in the right menu (if **Low Level** is not displayed, select **Offset** and select it again to switch to **Low Level**). Set the parameter in the right menu.

To Output Square Signals

The parameters of Square waveform are: **Frequency/Period**, **Start Phase**, **Amplitude/High Level**, **Offset/Low Level**.

To set the **Frequency/Period**, **Start Phase**, **Amplitude/High Level**, **Offset/Low Level**, please refer to *To Output Sine Signals* on page 100.

To Output Ramp Signals

The parameters of Ramp waveform are: **Frequency/Period**, **Start Phase**, **Amplitude/High Level**, **Offset/Low Level**, **Symmetry**.

To set the **Frequency/Period**, **Start Phase**, **Amplitude/High Level**, **Offset/Low Level**, please refer to *To Output Sine Signals* on page 100.

To Set the Symmetry of Ramp

Select **Symmetry** in the right menu of Ramp. Set the parameter in the right menu.

To Output Pulse Signals

The parameters of Pulse waveform are: **Frequency/Period**, **Start Phase**, **Amplitude/High Level**, **Offset/Low Level**, **Width/Duty Cycle**.

To set the **Frequency/Period**, **Start Phase**, **Amplitude/High Level**, **Offset/Low Level**, please refer to *To Output Sine Signals* on page 100.

To Set the Pulse Width of Pulse

Select **Width** in the right menu (if **Width** is not displayed, select **Duty Cycle** and select it again to switch to **Width**). Set the parameter in the right menu.

To Set the Duty Cycle of Pulse

Select **Duty Cycle** in the right menu (if **Duty Cycle** is not displayed, select **Width** and select it again to switch to **Duty Cycle**). Set the parameter in the right menu.

To Output Arbitrary Signals

The menu items of Arbitrary waveform are: **Frequency/Period**, **Start Phase**,

5. Use the Arbitrary Function Generator (Optional)

Amplitude/High Level, Offset/Low Level, New, File Browse, Built-in. You can operate the menu by using the menu selection buttons on the right.

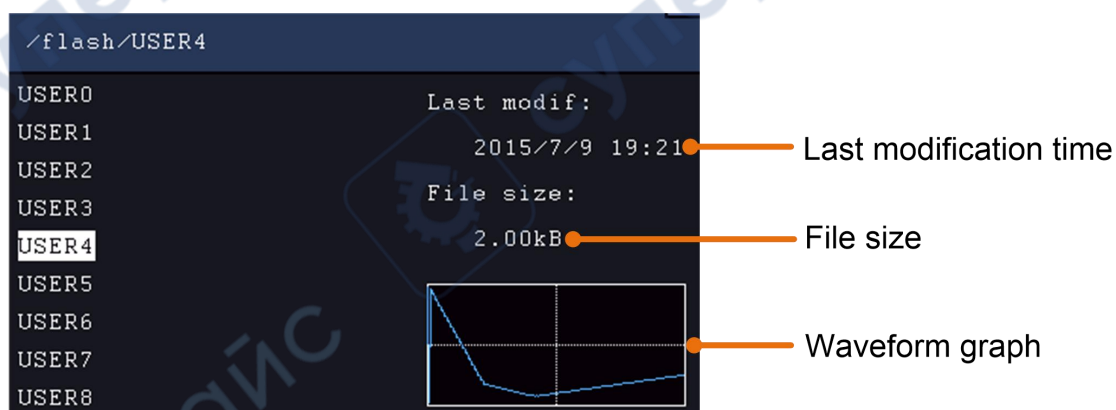
To set the Frequency/Period, Start Phase, Amplitude/High Level, Offset/Low Level, please refer to *To Output Sine Signals* on page 100.

The Arbitrary signal consists of two types: the user-definable waveform and the system built-in waveform.

Create a New Waveform

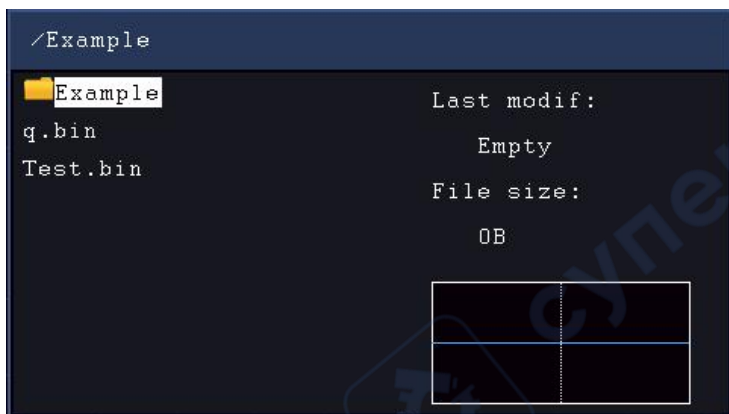
- (1) **Enter the operation menu:** Push **AFG** (single-channel) or **CH1/2** (dual-channel) button. Select **Arb** in the bottom menu, select **Others** in the right menu, and select **New**.
- (2) **Set the number of waveform points:** Select **Points** in the right menu, turn the **M** knob to change the value, or use the input keyboard (push the **M** knob to show it) to input the value and choose the unit. **X1**, **X1000**, **X1e6**, **X1e9** in the keyboard respectively represent 1, 1000, 1000000, 1000000000. The waveform points range is 2 - 8192.
- (3) **Set the interpolation:** Select **Intrpl** in the right menu, choose between **On/Off**. If you choose **On**, the points will be connected with beelines; otherwise, the voltages between two consecutive points will not change, and the waveform looks like a step-up one.
- (4) **Edit the waveform points:** Select **Edit Points** in the right menu.
 - Select **Point**, input the number of the point to be edited.
 - Select **Voltage**, input the voltage for the current point.
 - Repeat the step above, set all the points to your needs.
 - Select **Save**, enter the file system.

If you want to save the waveform to internal memory, select **Memory** in the right menu as **Internal**. Turn the **M** knob to select a file from USER0 through USER31. Select **Save** in the right menu.



If a USB device is connected, and you want to save the waveform to it, select **Memory** in the right menu as **USB**. The instrument lists a directory of the folders and files on the USB memory device. Select a folder or file using the **M** knob to scroll up

and down the list. To enter the current folder, select **Change Dir** in the right menu, select it again to return to the upper directory.



Enter the desired storage path, select **Save** in the right menu, an input keyboard pops up, input the file name, choose ↵ in the keyboard to confirm. The waveform is saved as BIN file in the folder.

Note: The input length can have up to 35 characters.



File Browse

To read a waveform stored in internal storage or USB device:

- (1) Push **AFG** (single-channel) or **CH1/2** (dual-channel) button. Select **Arb** in the bottom menu, select **Others** in the right menu, and select **File Browse**.
- (2) Select the desired waveform file in internal storage (FLASH) or USB device (USBDEVICE).
- (3) Select **Read** in the right menu.

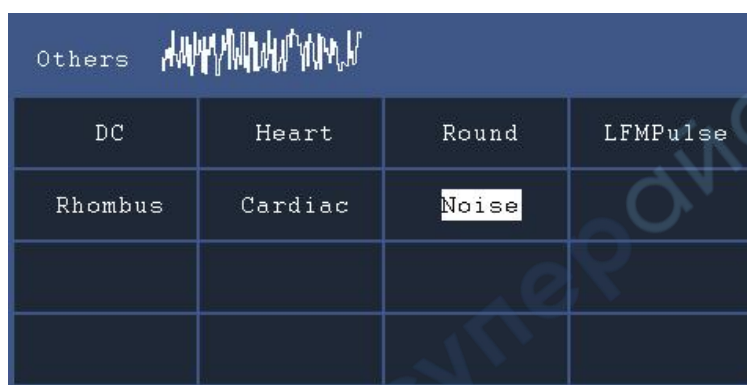
Built-in Waveform

There are 46 built-in Arbitrary waveforms.


Steps for selecting the built-in waveform:

- (1) Push **AFG** (single-channel) or **CH1/2** (dual-channel) button to show the bottom menu of generator.
- (2) Select **Arb** in the bottom menu, select **Others** in the right menu, and select **Built-in**.
- (3) Select **Common**, **Math**, **Window** or **Others** in the right menu. E.g. select **Others** to enter the following interface.

5. Use the Arbitrary Function Generator (Optional)



- (4) Turn the **M** knob to select the desired waveform (or touch if the LCD is touchscreen).
E.g. select **Noise**. Select **Select** to output the noise waveform.

Note: For single-channel, you can push  on the front panel to output DC.

Built-in Waveform Table

Name	Explanation
Common	
StairD	Stair-down waveform
StairU	Stair-up waveform
StairUD	Stair-up and stair-down waveform
Trapezia	Trapezoid waveform
RoundHalf	RoundHalf wave
AbsSine	Absolute value of a Sine
AbsSineHalf	Absolute value of half a Sine
SineTra	Sine transverse cut
SineVer	Sine vertical cut
NegRamp	Negative ramp
AttALT	Gain oscillation curve
AmpALT	Attenuation oscillation curve
CPulse	Coded pulse
PPulse	Positive pulse
NPulse	Negative pulse
Maths	
ExpRise	Exponential rise function
ExpFall	Exponential fall function
Sinc	Sinc function
Tan	Tangent
Cot	Cotangent
Sqrt	Square root
XX	Square function
HaverSine	HaverSine function
Lorentz	Lorentz function

5. Use the Arbitrary Function Generator (Optional)

ln	Natural logarithm function
Cubic	Cubic function
Cauchy	Cauchy distribution
Besselj	BesselI function
Bessely	BesselII function
Erf	Error function
Airy	Airy function
Windows	
Rectangle	Rectangle window
Gauss	Gauss distribution
Hamming	Hamming window
Hann	Hanning window
Bartlett	Bartlett window
Blackman	Blackman window
Laylight	Laylight window
Triang	Triangle window (Fejer window)
Others	
DC	DC signal
Heart	Heart signal
Round	Round signal
LFMPulse	Linear FM pulse
Rhombus	Rhombus signal
Cardiac	Cardiac signal
Noise	Noise signal

Frequency Response Analysis

The Frequency Response Analysis (FRA) feature controls the built-in waveform generator to sweep a sine wave across a range of frequencies while measuring the input to and output from a device under test. At each frequency, gain and phase are measured and plotted on a frequency response Bode chart. When the frequency response analysis completes, you can move a marker across the chart to see the measured gain and phase values at each frequency point. You can also adjust the chart's scale and offset settings for the gain and phase plots.

Note: If the signal is disturbed seriously, it is recommended to select Average in Acquire Mode before running the analysis, the averages can only be set as 4 or 16, and then run the analysis.

Push the **Utility** button, select **Function** in the bottom menu, select **FRA** in the left menu.

The description of **FRA Menu** is shown as the follows:

Function Menu	Setting	Description
<input type="checkbox"/> FRA	<input type="checkbox"/> FRA	Check to enable FRA function and show FRA scale line and chart.

5. Use the Arbitrary Function Generator (Optional)

	<input type="checkbox"/> Transparent	When unchecked, FRA information is shown on the FRA window. When checked, FRA information is shown on the waveform display area.
	Marker	Turn Multipurpose knob to move the marker, view measured gain and phase values.
	Sweep Step <input type="checkbox"/> Fine	When unchecked, the sweep step is 0.1dB. When checked, the sweep step is 0.01dB.
	Save	Click Save function can restore current picture.
Setup	Input V CH1	Input V is input from CH1. Output V is input from CH2.
	Output V CH2	(Note: The menus are not for selecting menu items, only for showing information.)
	Min Freq <input type="checkbox"/> Fine	Turn Multipurpose knob to set frequency sweep min value. Check to enable fine-tuning.
	Max Freq <input type="checkbox"/> Fine	Turn Multipurpose knob to set frequency sweep max value. Check to enable fine-tuning.
	Amplitude <input type="checkbox"/> Fine	Turn Multipurpose knob to set waveform generator amplitude. Check to enable fine-tuning. Note: The amplitude range is 2 mVpp to 6 Vpp.
Chart	Gain Scale	Adjust scale of gain plot, range from 5dB to 500dB.
	Gain Offset	Adjust offset of gain plot, range from -250dB to 250dB.
	Phase Scale	Adjust scale of phase plot, range from 5° to 180°.
	Phase Offset	Adjust offset of phase plot, range from -180° to 180°.
	Autoscale	Autoscale gain and phase plots.
<input type="checkbox"/> Analysis	Run/stop the analysis. F: Frequency; G: Gain; P: Phase.	

To run the frequency response analysis, do the following:

1. The waveform generator output is connected to a device under test. The input to the device is probed by CH1 of the oscilloscope. The output from the device is probed by CH2 of the oscilloscope.
2. Push the **Utility** button, select **Function** in the bottom menu, select **FRA** in the left menu
3. In the bottom menu, select FRA. In the right menu, check FRA, and set other menu items.
4. In the bottom menu, select **Setup** or **Chart**. In the right menu, set the menu items.
5. In the bottom menu, check Analysis to run the analysis.

6. Use the Multimeter (Optional)

Input Terminals

The input terminals are on the back of the oscilloscope, which marked as **10A**, **mA**, **COM**, **V/Ω/C**.



Figure 6-1 Multimeter Input Terminals

DMM Menu

Push **DMM** button on the front panel to enter/exit the multimeter function. The button backlight will be lighted when the multimeter function is enabled.

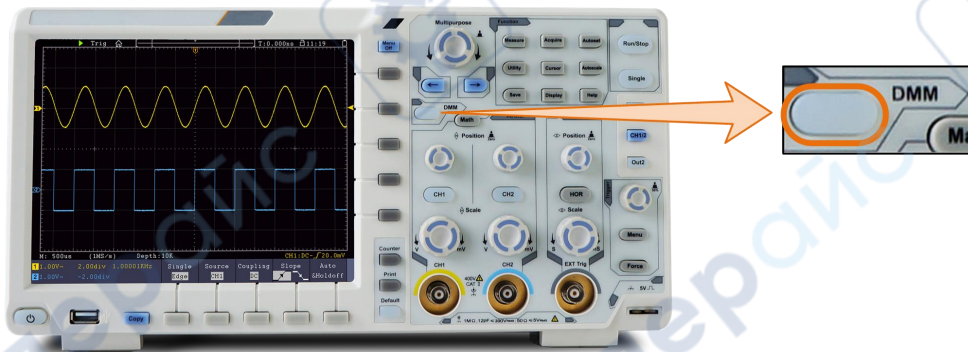


Figure 6-2 Multimeter Button

The bottom menu of multimeter is as below:

Menu	Setting	Description
Current	ACA	Measuring AC current.
	DCA	Measuring DC current.
Voltage	ACV	Measuring AC voltage.
	DCV	Measuring DC voltage.
R		Measuring resistance.
		Testing diode.
		Testing for continuity.
C		Measuring capacitance.

6. Use the Multimeter (Optional)

Hold	ON OFF	Freeze the display during measurement.
Configure	Relative	When making relative measurements, reading is the difference between a stored reference value and the input signal.
	Show Info ON OFF	Show/Hide the information window.
	Auto Range	Select auto range mode.
	Switch Range	Select manual range mode, press to switch range.
	Current mA 10A (Only for current measurement)	Select the current range.

DMM Information Window

The Multimeter Information Window is displayed on the top right of the screen.

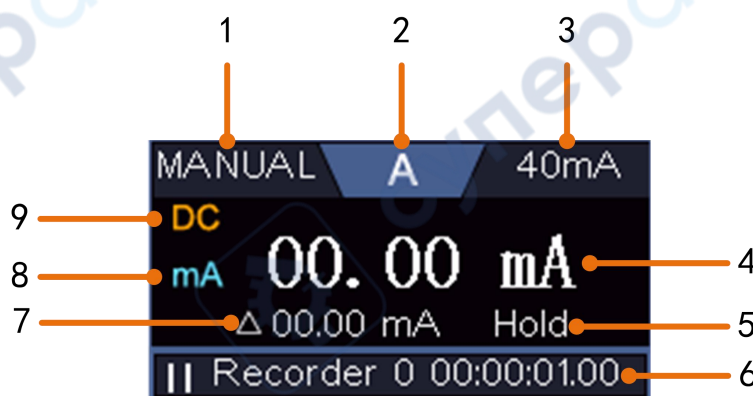




Figure 6-3 Multimeter Information Window

Description

- Manual/Auto range indicators, **MANUAL** refers to the measuring range in manual operation mode and **AUTO** refers to the measuring range in automatic operation mode.
- Measurement mode indicators:
 - A** ----- Current measurement
 - V** ----- Voltage measurement
 - R** ----- Resistance measurement
 -  ----- Diode measurement
 -  ----- Continuity test
 - C** ----- Capacitance measurement
- Range.
- Measurement display ("OL" is short for overload, indicates the reading exceeds the display range)

5. Data hold mode is enabled.
6. Multimeter recorder (See "*Multimeter Recorder*" on page 112).
7. The reference value of the relative measurement.
8. Range of measuring current: mA or 10A.
9. AC or DC when measuring current or voltage.

Making Multimeter Measurements

Measuring AC or DC Current

To measure a AC or DC current which is **less than 400 mA**, do the following:

- (1) Push **DMM** button on the front panel. Select **Current** in the bottom menu, select it again to switch between **ACA** (AC current) or **DCA** (DC current).
- (2) Select **Configure** in the bottom menu, select **Current** as **mA** in the right menu.
- (3) Connect the black test lead to the **COM** terminal on the back of the oscilloscope. Connect the red test lead to the **mA** terminal.
- (4) Turn off the power of the measured circuit. Discharge all high- voltage capacitors.
- (5) Disconnect the circuit path to be tested. Connect the black test lead to one side of the circuit (with a lower voltage); connect the red test lead to the other side (with a higher voltage). Reversing the leads will produce a negative reading, but will not damage the multimeter.
- (6) Turn on the power of the measured circuit, and read the display.
- (7) Turn off the power of the measured circuit and discharge all high-voltage capacitors. Remove the test leads and restore the circuit to the original condition.

To measure a AC or DC current which is **400 mA to 10 A**, do the following:

- (1) Push **DMM** button on the front panel. Select **Current** in the bottom menu, select it again to switch between **ACA** (AC current) or **DCA** (DC current).
- (2) Select **Configure** in the bottom menu, select **Current** as **10A** in the right menu.
- (3) Connect the black test lead to the **COM** terminal on the back of the oscilloscope. Connect the red test lead to the **10A** terminal.
- (4) Turn off the power of the measured circuit. Discharge all high- voltage capacitors.
- (5) Disconnect the circuit path to be tested. Connect the black test lead to one side of the circuit (with a lower voltage); connect the red test lead to the other side (with a higher voltage). Reversing the leads will produce a negative reading, but will not damage the multimeter.
- (6) Turn on the power of the measured circuit, and read the display.
- (7) Turn off the power of the measured circuit and discharge all high-voltage capacitors. Remove the test leads and restore the circuit to the original condition.

Measuring AC or DC Voltage


- (1) Push **DMM** button on the front panel. Select **Current** in the bottom menu, select it again to switch between **ACA** (AC current) or **DCA** (DC current).
- (2) Connect the black test lead to the **COM** terminal on the back of the oscilloscope and

6. Use the Multimeter (Optional)



the red test lead to the **V/Ω/C** terminal.

- (3) Probe the test points and read the display.



Measuring Resistance

- (1) Push **DMM** button on the front panel. Select  in the bottom menu, select **R**.
- (2) Connect the black test lead to the **COM** terminal on the back of the oscilloscope and the red test lead to the **V/Ω/C** terminal.
- (3) Probe the test points and read the display.


Testing Diodes

- (1) Push **DMM** button on the front panel. Select  in the bottom menu, select it until switching to .
- (2) Connect the black test lead to the **COM** terminal on the back of the oscilloscope and the red test lead to the **V/Ω/C** terminal.
- (3) Connect the red test lead to the positive terminal (anode) of the diode and the black test lead to the negative terminal (cathode). The cathode of a diode is indicated with a band. Read the diode forward bias.

Testing for Continuity

- (1) Push **DMM** button on the front panel. Select  in the bottom menu, select it until switching to .
- (2) Connect the black test lead to the **COM** terminal on the back of the oscilloscope and the red test lead to the **V/Ω/C** terminal.
- (3) Probe the test points to measure the resistance in the circuit. If the reading is below 50 Ω, the multimeter will beep.

Measuring Capacitance

- (1) Push **DMM** button on the front panel. Select  in the bottom menu, select it until switching to **C**.
- (2) Insert the supplied capacitance measurer to the **COM** terminal and the **V/Ω/C** terminal on the back of the oscilloscope.
- (3) Insert the capacitance to the capacitance measurer, then screen shows the capacitance reading.

Note: when measuring the capacitance which is less than 5 nF, please use relative value measuring mode to improve measuring precision.

Multimeter Features

Data Hold Mode

You can freeze the display for any function.

- (1) Select **Hold** in the bottom menu as **ON**. **HOLD** will be shown on the display.
- (2) Select **OFF** to exit this mode.

Making Relative Measurements

When making relative measurements, reading is the difference between a stored reference value and the input signal.

- (1) Select **Configure** in the bottom menu, select **Relative** in the right menu to enter the relative mode.

The measurement value at this time is stored as the reference value, and displayed behind Δ .

In this mode, current reading = input value - reference value.

- (2) Press it again to exit the mode.

Note: This function is not available when measuring resistance, diodes, and testing for continuity.

Information Display

Show/hide the information window on the top right of the display.

- (1) Select **Configure** in the bottom menu, select **Show Info** in the right menu as **ON**. The information window will be shown on the display.
- (2) Select **OFF** to hide.

Auto or Manual Range

Auto range is set as default. To switch auto or manual range, do the following steps:

- (1) Select **Configure** in the bottom menu.
- (2) Select **Auto Range** in the right menu, **AUTO** will be shown on the display.
- (3) Select **Switch Range** in the right menu, **MANUAL** will be shown on the display.

Press this softkey to switch range.

Note: When testing diode, testing continuity, and measuring capacitance, manual range is disabled.

Multimeter Recorder

You can use the multimeter data recorder to record the measurements when measuring current/voltage by multimeter (optional).

Push the **Utility** button, select **Function** in the bottom menu, select **DAQ** in the left menu.

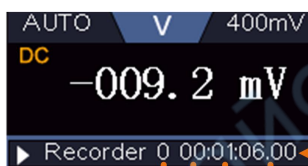
The description of **DAQ Menu** is shown as the follows:

6. Use the Multimeter (Optional)

Function Menu	Setting	Description
Set	Interval	Set the record interval (0.5s - 10s, step by 0.5s)
	Duration	"d h m s" represents day, hour, minute, second. E.g. "1 02:50:30" represents a day and 2 hours, 50 minutes and 30 seconds. Press Duration to switch between the time unit, turn the M knob to set the value. Max duration: 3 days for internal storage, 10 days for external storage.
	Enable	Turn on or off the recorder.
STRT STOP	Start or stop recording.	
Storage	Internal External	Save to internal storage or USB memory device.
Export	When internal storage is selected, you can export the internal record file to a USB memory device.	

To record the current/voltage measurements in the multimeter, do the following:

1. Push **DMM** button on the front panel to enter the multimeter function. Select **Current** or **Voltage** in the bottom menu.
If you want to enter the relative mode, select **Configure** in the bottom menu, select **Relative** in the right menu.
2. Push the **Utility** button, select **Function** in the bottom menu, select **DAQ** in the left menu.
3. Select **Storage** in the bottom menu, select **Internal** or **External** in the right menu. If you select External, insert the USB memory device into the front-panel USB port on your instrument.
4. Select **Set** in the bottom menu, select **Enable** in the right menu as **ON**.
5. Select **Interval** in the right menu, turn the **M** knob to set it.
6. Select **Duration** in the right menu, push it to switch between the time unit, turn the **M** knob to set the corresponding value.
7. Select **STRT** in the bottom menu.
8. **When external storage is selected:** The instructions will be shown on the screen. The record file will be named as "Multimeter_Recorder.csv". If a file with the same name already exists in the USB memory device, it will be overwritten. (If you want to keep the existing file, back up it to other location in advance.) Select **STRT** in the bottom menu to start recording.
9. When the record time gets to the defined duration, the recording will be ended. If you want to end recording prematurely, select **STOP** in the bottom menu.



Record time, use the defined interval as its refresh interval

Day H M S

10. **When internal storage is selected:** You can export the internal record file to a USB

6. Use the Multimeter (Optional)

memory device. Insert the USB memory device into the front-panel USB port on your instrument. Select **Export** in the bottom menu. The instructions will be shown on the screen. The export file will be named as "Multimeter_Recorder.csv". If a file with the same name already exists in the USB memory device, it will be overwritten. (If you want to keep the existing file, back up it to other location in advance.) Select **Export** in the bottom menu to export.

How to chart the data

You can open the CSV file using Microsoft Excel, or your favorite spreadsheet application, and create charts based on the data.

In the following steps, Microsoft Excel 2010 is used as an example.

1. Open Multimeter_Recorder.csv in Excel.

	A	B	C
1	DMM RECORDER		
2	Time interval:2.0(s)		
3	DCV		
4	RELATIVE:11.600000(mV)		
5	time	index	Voltage(mV)
6		1	-0.4

2. Select the data that you want to chart (see *Figure 6-4*).
3. On the **Insert** tab, in the **Charts** group, click **Line**, and then click **Line in 2-D Line** (see *Figure 6-5*).
4. The chart will be displayed (see *Figure 6-6*). If you want to keep the chart, save the file to XLS format.

	A	B	C
1	DMM RECORDER		
2	Time interval:1.0(s)		
3	DCV		
4	RELATIVE:OFF		
5	time	index	Voltage(mV)
6		1	2.8
7		2	2.8
8		3	2.8
9		4	2.8
10		5	2.7
11		6	2.7
12		7	2.7
13		8	2.7
14		9	2.7
15	0 00:00:1	10	2.7
16		11	2.6
17		12	2.6
18		13	2.6
19		14	2.6
20		15	2.6
21		16	2.5
22		17	2.5
23		18	2.5
24		19	2.5
25	0 00:00:2	20	2.5
26		21	2.5
27		22	2.6

Figure 6-4

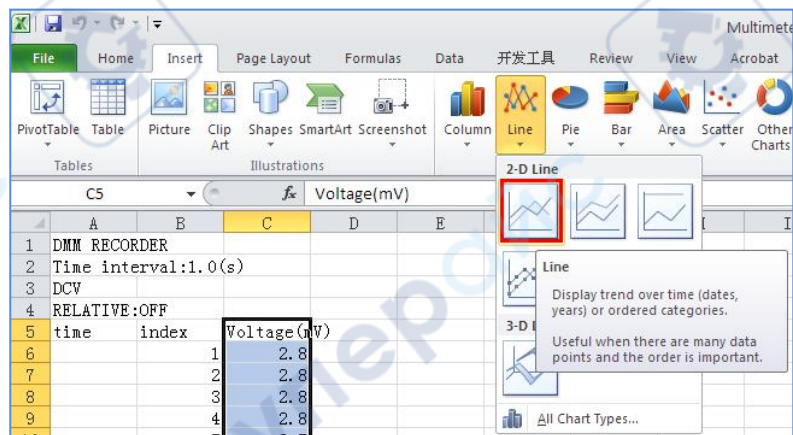


Figure 6-5

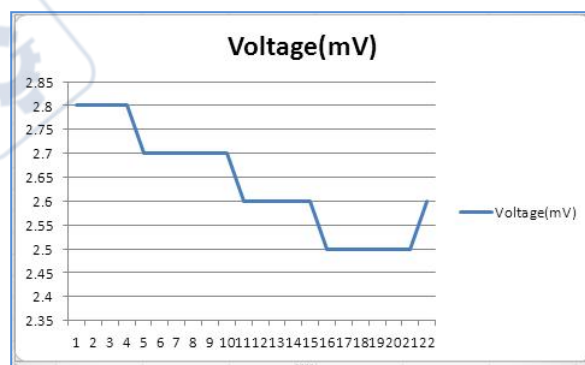


Figure 6-6

7. Communication with PC

The oscilloscope supports communications with a PC through USB, LAN port or Wi-Fi. You can use the Oscilloscope communication software to store, analyze, display the data and remote control.

For the specific operation method of Oscilloscope host software, please download and view the host help document on our download website.

Here's how to connect to a computer. Please get the host software installation package on your computer from our official website, double-click it, and click according to the prompts until the installation is complete. Then, there are several connections you can choose from.

Using USB Port

- (1) **Set the USB device protocol type of the instrument:** Click **Utility** → **Function** → **Function** → **Output** → **Device**, switch to PC.
- (2) **Connection:** Use a USB data cable to connect the **USB Device port** in the right panel of the Oscilloscope to the USB port of a PC.
- (3) **Port setting of the software:** Run the Oscilloscope software; click "Communications" on the menu bar, choose "Ports-Settings", in the setting dialog, choose "Connect using" as "USB". After connect successfully, the connection information in the bottom right corner of the software will turn green.

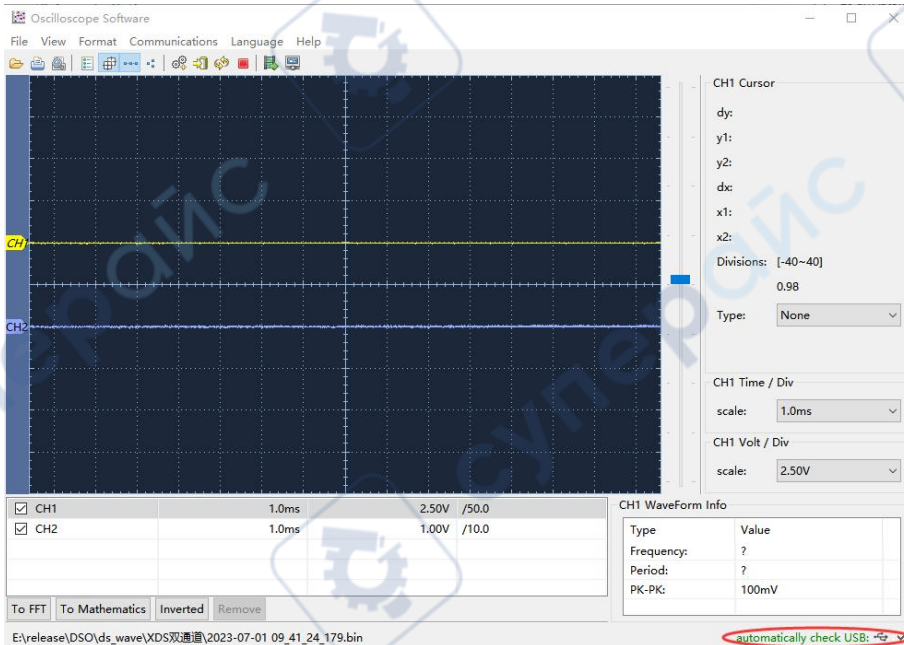


Figure 7- 1 Connect with PC through USB port

Using LAN Port

Connect directly

- (1) **Connection.** Plug in the LAN cable to the LAN port in the back of the oscilloscope; plug the other end into the LAN interface of the computer.
- (2) **Set the network parameters of the computer.** Since the oscilloscope can not support obtaining an IP address automatically, you should assign a static IP address. Here we set the IP address to 192.168.1.71.

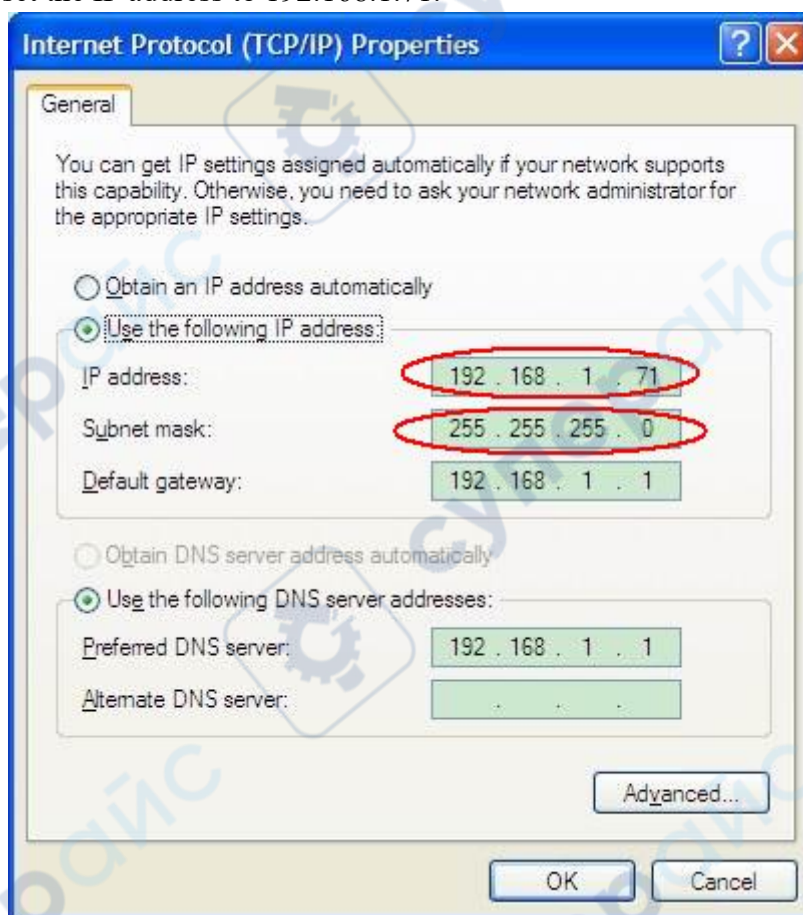


Figure 7-2 Set the network parameters of the computer

- (3) **Set the network parameters of the Oscilloscope Software.** Run the software on the computer; choose the "Ports-settings" of the "Communications" menu item. Set "Connect using" to LAN. About the IP, the first three bytes is same as the IP in the step (2), the last byte should be different. Here, we set it to 192.168.1.72. The range of the port value is 0 - 4000, but the port which under 2000 is always used, so it is suggested to set it to the value above 2000. Here, we set it to 3000.

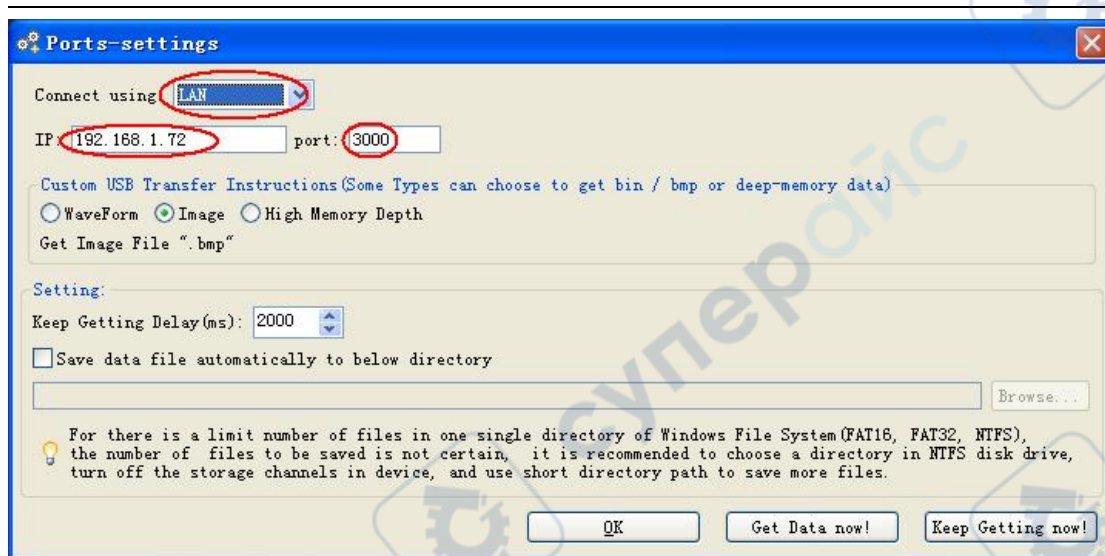


Figure 7-3 Set the network parameters of the Oscilloscope Software

- (4) **Set the network parameters of the oscilloscope.** In the oscilloscope, push the **Utility** button. Select **Function** in the bottom menu. Select **LAN Set** in the left menu. In the bottom menu, set the **Type** item as **LAN**, and select **Set**. In the right menu, set **IP** and **Port** to the same value as the "Ports-settings" in the software in step (3). Select **Save set** in the bottom menu, it prompts "Reset to update the config". After resetting the oscilloscope, if you can get data normally in the oscilloscope software, the connection is successful.

Set	
IP	
M 192	168
1	72
Port	
3000	
Gateway	
192	168
1	1
Phy addr	
B7	F1
F4	B8
5F	D0
Subnet mask	
255	255
255	0

Figure 7-4 Set the network parameters of the oscilloscope

Connect through a router

- (1) **Connection.** Use a LAN cable to connect the oscilloscope with a router, the LAN port of the oscilloscope is in the right side panel; the computer should be connected to the router too.
- (2) **Set the network parameters of the computer.** Since the oscilloscope can not support obtaining an IP address automatically, you should assign a static IP address. The Default gateway and Subnet mask should be set according to the router. Here we

set the IP address to 192.168.1.71, Subnet mask is 255.255.255.0, Default gateway is 192.168.1.1.

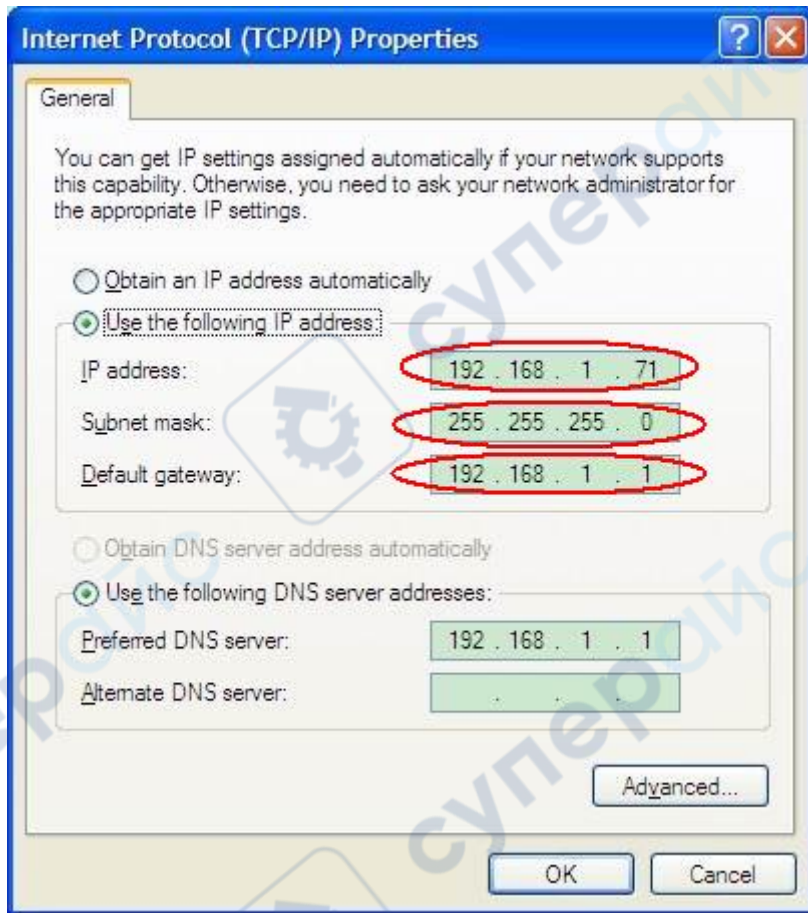


Figure 7-5 Set the network parameters of the computer

- (3) **Set the network parameters of the Oscilloscope Software.** Run the software on the computer; choose the "Ports-settings" of the "Communications" menu item. Set "Connect using" to LAN. About the IP, the first three bytes is same as the IP in the step (2), the last byte should be different. Here, we set it to 192.168.1.72. The range of the port value is 0 - 4000, but the port which under 2000 is always used, so it is suggested to set it to the value above 2000. Here, we set it to 3000.

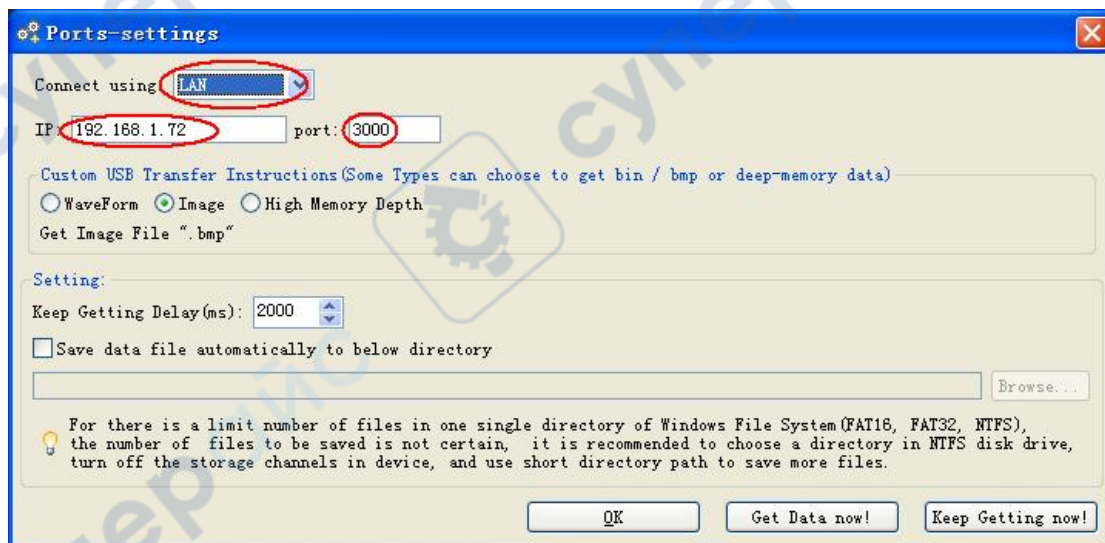


Figure 7-6 Set the network parameters of the Oscilloscope Software

- (4) **Set the network parameters of the oscilloscope.** In the oscilloscope, push the **Utility** button. Select **Function** in the bottom menu. Select **LAN Set** in the left menu. In the bottom menu, set the **Type** item as **LAN**, and select **Set**. In the right menu, set **IP** and **Port** to the same value as the "Ports-settings" in the software in step (3). The Netgate and Net mask should be set according to the router. Select **Save set** in the bottom menu, it prompts "Reset to update the config". After resetting the oscilloscope, if you can get data normally in the oscilloscope software, the connection is successful.

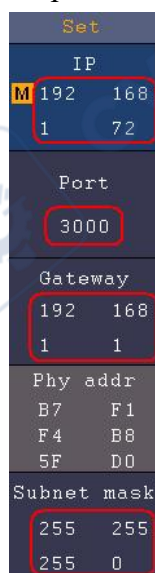



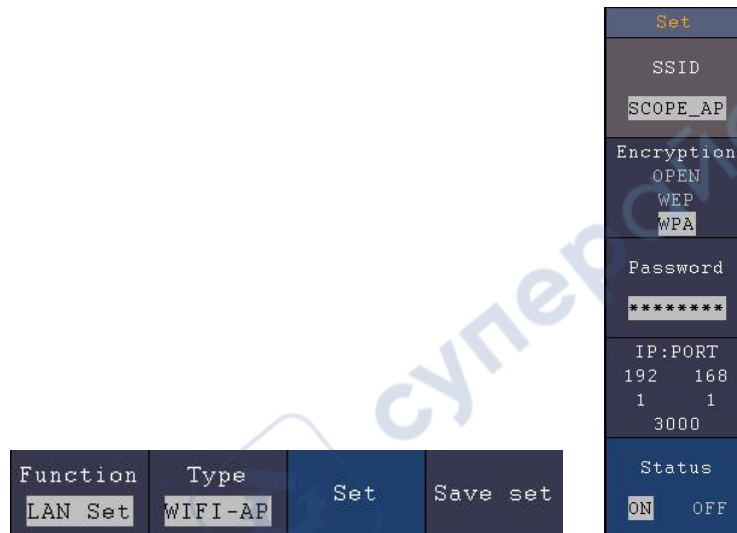
Figure 7-7 Set the network parameters of the oscilloscope

Using Wi-Fi to Connect with PC (Optional)

Connect with PC as Wi-Fi Access Point

PC should support Wi-Fi.

- (1) **Set the oscilloscope.** In the oscilloscope, push the **Utility** button. Select **Function** in the bottom menu. Select **LAN Set** in the left menu. In the bottom menu, set the **Type** item as **WIFI-AP**, and select **Set** in the bottom menu.
- (2) In the right menu, select **SSID**, a keyboard will pop up. You can turn and push the **M** knob, or touch the keyboard (if the LCD is touchscreen) to set the access point name.
- (3) In the right menu, select **Encryption**, push again to set the type. **Open** type needs no password. **WEP** or **WPA** type need to set the password. You can select **WPA**. In the right menu, select **Password**, use the keyboard to set the Wi-Fi password (8 to 32 characters).
- (4) In the right menu, select **IP:PORT**, **IP** is fixed by the oscilloscope, and can not be edited. Here IP is 192.168.1.1. Turn the **M** knob to set the **PORT**. Here, we set it to 3000.
- (5) After setting, select **ON** in the **Status** menu. The  icon appears on the top right of the screen.



- (6) Select **Save set** in the bottom menu to save current settings.
- (7) **Set Wi-Fi connection on PC.** Enter the Wi-Fi settings on PC, select the oscilloscope access point to connect, enter the set password.



- (8) **Set the network parameters of the Oscilloscope Software.** Run the software on the computer; choose the "Ports-settings" of the "Communications" menu item. Set "Connect using" to LAN. Set **IP** and **Port** to the same value in the oscilloscope in the step (4). If you can get data normally, the connection is successful.

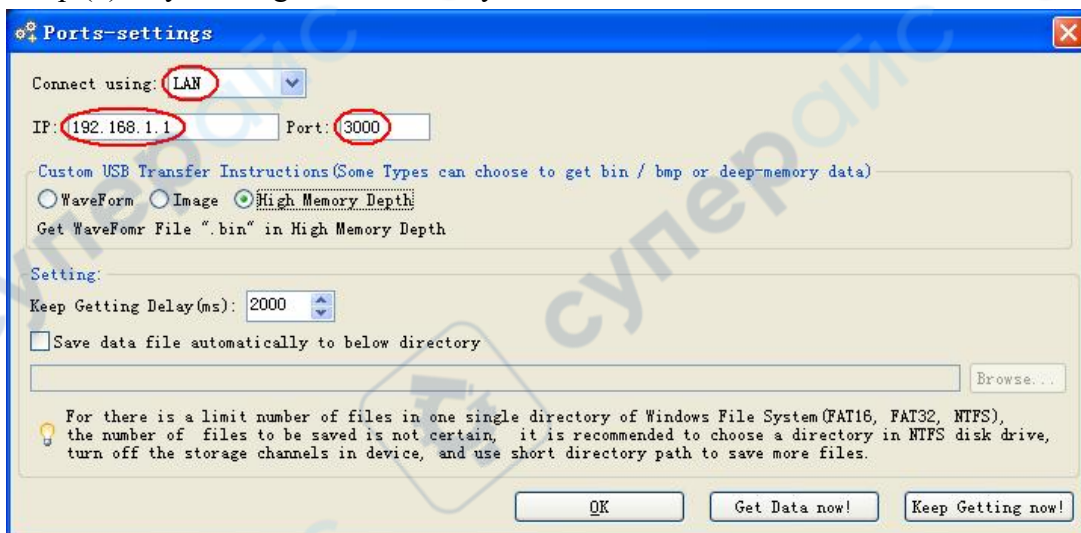



Figure 7-8 Set the network parameters of the Oscilloscope Software

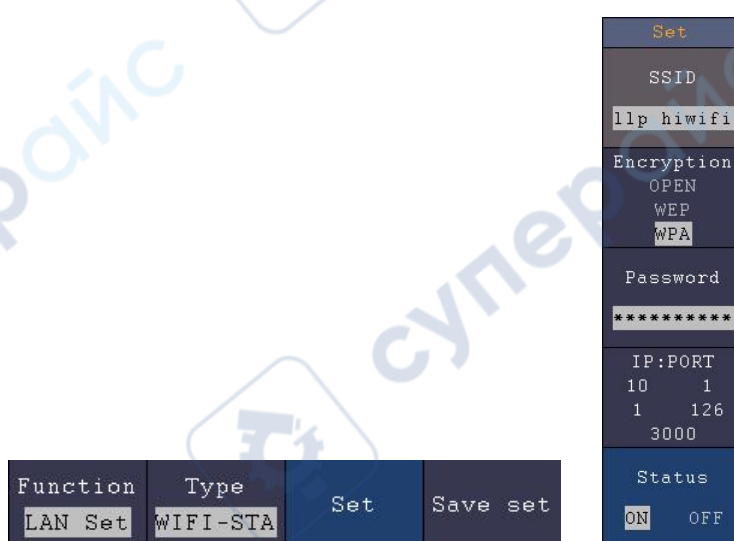
Connect with PC as Wi-Fi Station

The oscilloscope and PC should be on the same network (LAN).

- (1) In the oscilloscope, push the **Utility** button. Select **Function** in the bottom menu.

Select **LAN Set** in the left menu. In the bottom menu, set the **Type** item as **WIFI-STA**, and select **Set** in the bottom menu.

- (2) In the right menu, select **SSID**, a keyboard will pop up. Input the name of the Wi-Fi hotspot. You can turn and push the **M** knob, or touch the keyboard (if the LCD is touchscreen).
- (3) In the right menu, select **Encryption**, push to set the Encryption type of the Wi-Fi hotspot. **Open** type needs no password. **WEP** or **WPA** type need to input the password. In the right menu, select **Password**, use the keyboard to input the Wi-Fi hotspot password.
- (4) In the right menu, select **IP:PORT**, Turn the **M** knob to set the **PORT**. Here, we set it to 3000.
- (5) After setting, select **ON** in the **Status** menu. The value of **IP** is displayed in **IP:PORT** menu. Here IP is 10.1.1.126. A changing icon  appears on the top right of the screen.



- (6) Select **Save set** in the bottom menu to save current settings.
- (7) **Set the network parameters of the computer.** Set IP in the computer, the first three bytes is same as the IP in the oscilloscope, the last byte should be different. Here, we set it to 10.1.1.123. The Default gateway and Subnet mask should be set according to the router.

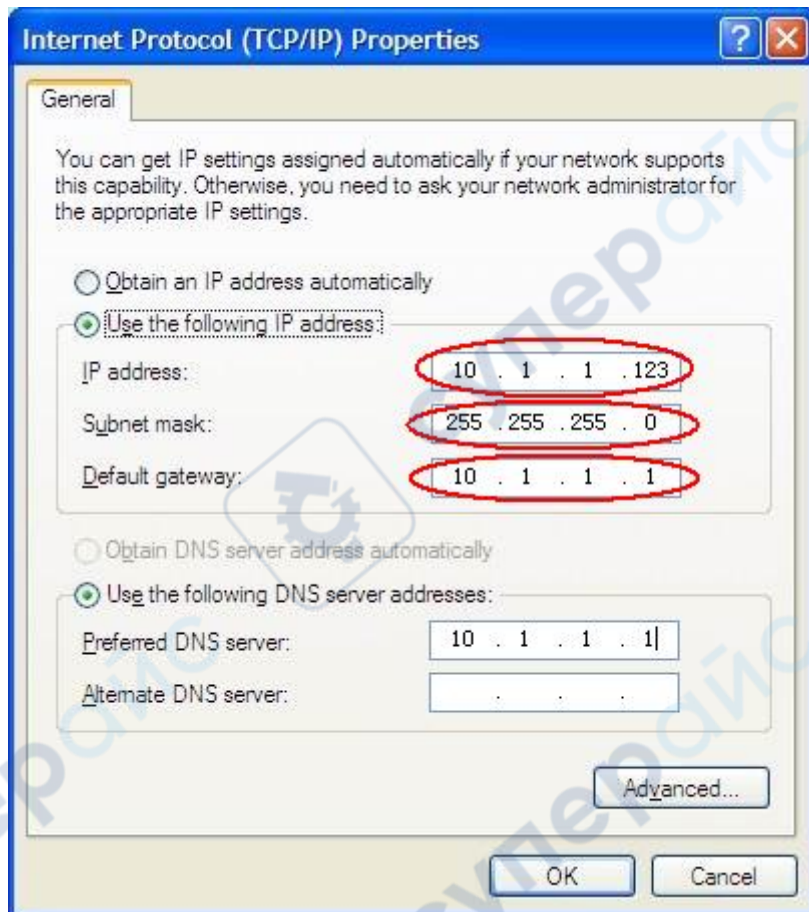


Figure 7-9 Set the network parameters of the computer

- (8) **Set the network parameters of the Oscilloscope Software.** Run the software on the computer; choose the "Ports-settings" of the "Communications" menu item. Set "Connect using" to LAN. Set **IP** and **Port** to the same value in the oscilloscope. If you can get data normally, the connection is successful.

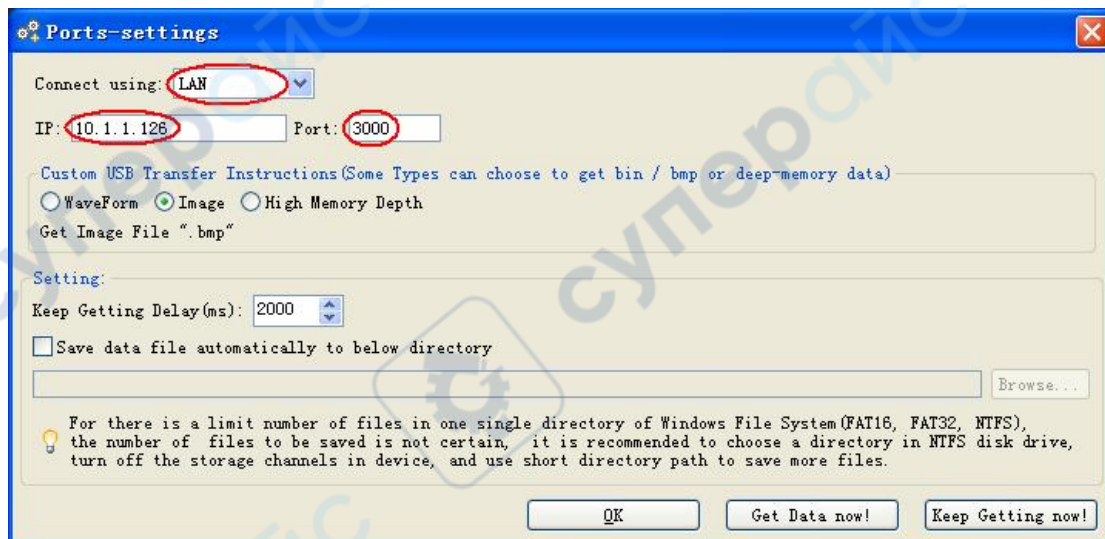


Figure 7-10 Set the network parameters of the Oscilloscope Software

8. Communication with Android Device via Wi-Fi (Optional)

The oscilloscope supports communications with Android based smart device via Wi-Fi. You can use the free application software on the Android based smart devices to view the waveform synchronously, perform remote control, The waveform can be saved as image (BMP, PNG) or file (CSV, BIN), or shared via installed sharing apps.


System Requirements of Mobile Devices

- Android Versions: 4.0 and above.

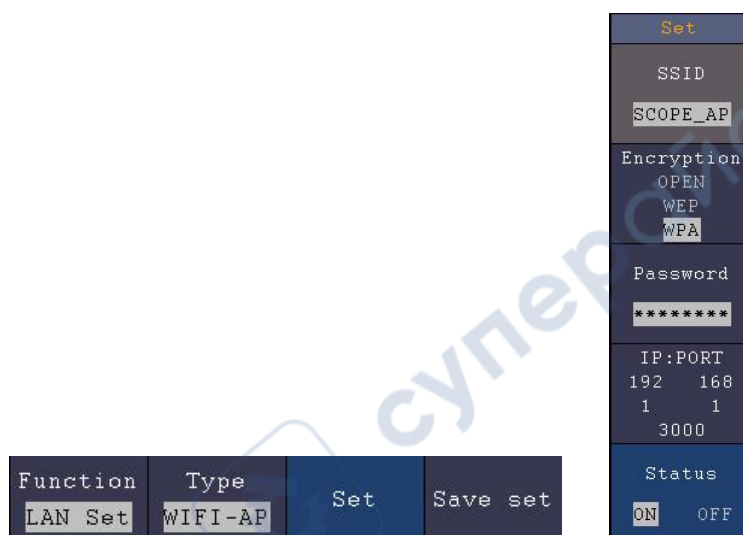
How to Connect

In Wi-Fi settings of the oscilloscope, there are two connection types. One is WIFI-AP (Access Point), the oscilloscope is set as Wi-Fi access point, the Android device can be connected to it directly. The other type is WIFI-STA (Station), the oscilloscope is set as Wi-Fi station. The Android device can be connected to it through a Wi-Fi hotspot.

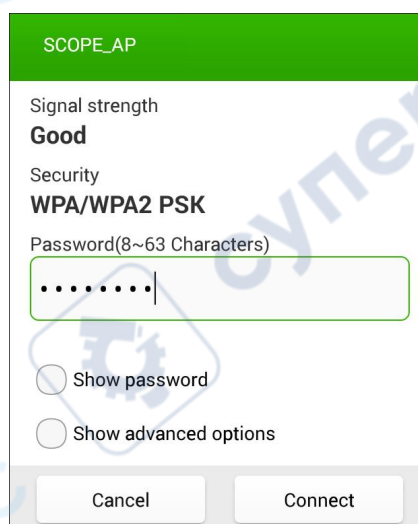
Connect with APP as Wi-Fi Access Point

- (1) In the oscilloscope, push the **Utility** button. Select **Function** in the bottom menu. Select **LAN Set** in the left menu. In the bottom menu, set the **Type** item as **WIFI-AP**, and select **Set** in the bottom menu.
- (2) In the right menu, select **SSID**, a keyboard will pop up. You can turn and push the **M** knob, or touch the keyboard (if the LCD is touchscreen) to set the access point name.
- (3) In the right menu, select **Encryption**, push again to set the type. **Open** type needs no password. **WEP** or **WPA** type need to set the password. You can select **WPA**. In the right menu, select **Password**, use the keyboard to set the Wi-Fi password (8 to 32 characters).
- (4) In the right menu, select **IP:PORT**, **IP** is fixed by the oscilloscope, and can not be edited. Turn the **M** knob to set the **PORT**.
- (5) After setting, select **ON** in the **Status** menu. The  icon appears on the top right of the screen.

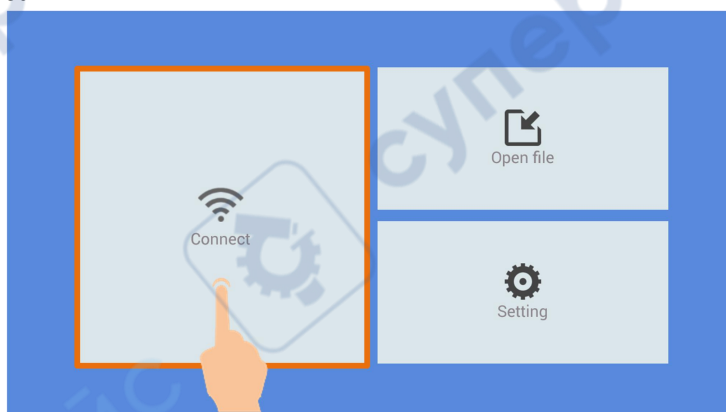
8.Communication with Android Device via Wi-Fi (Optional)



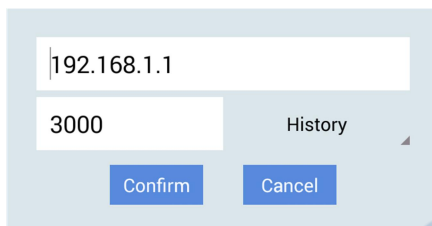
- (6) Select **Save set** in the bottom menu to save current settings.
- (7) In Android device, enter the Wi-Fi settings, select the oscilloscope access point to connect, enter the set password.




- (8) In Android device, launch the application.
- (9) Click **connect** on the left.

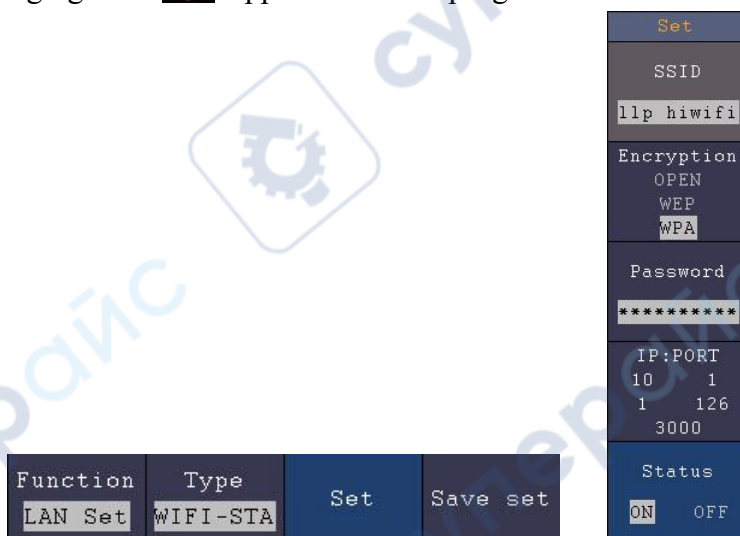


- (10) Set **IP** and **Port** to the same value as the setting in the oscilloscope. Click **Confirm** to connect. Click **History** to recall the history settings.



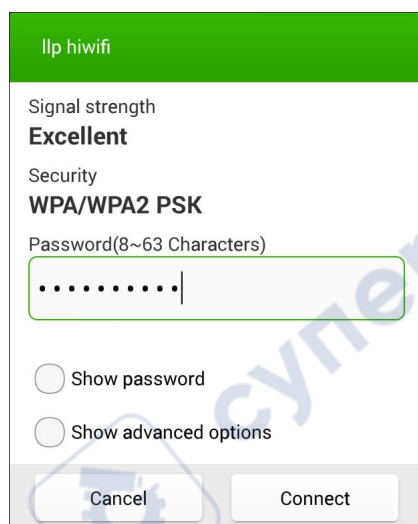
Connect with APP as Wi-Fi Station

- (1) In the oscilloscope, push the **Utility** button. Select **Function** in the bottom menu. Select **LAN Set** in the left menu. In the bottom menu, set the **Type** item as **WIFI-STA**, and select **Set** in the bottom menu.
- (2) In the right menu, select **SSID**, a keyboard will pop up. Input the name of the Wi-Fi hotspot. You can turn and push the **M** knob, or touch the keyboard (if the LCD is touchscreen).
- (3) In the right menu, select **Encryption**, push to set the Encryption type of the Wi-Fi hotspot. **Open** type needs no password. **WEP** or **WPA** type need to input the password. In the right menu, select **Password**, use the keyboard to input the Wi-Fi hotspot password.
- (4) In the right menu, select **IP:PORT**, Turn the **M** knob to set the **PORT**.
- (5) After setting, select **ON** in the **Status** menu. The value of **IP** is displayed in **IP:PORT** menu. A changing icon  appears on the top right of the screen.



- (6) Select **Save set** in the bottom menu to save current settings.
- (7) In Android device, enter the Wi-Fi settings, select the oscilloscope access point to connect, enter the set password.

8.Communication with Android Device via Wi-Fi (Optional)



llp hiwifi

Signal strength
Excellent

Security
WPA/WPA2 PSK

Password(8~63 Characters)
.....|

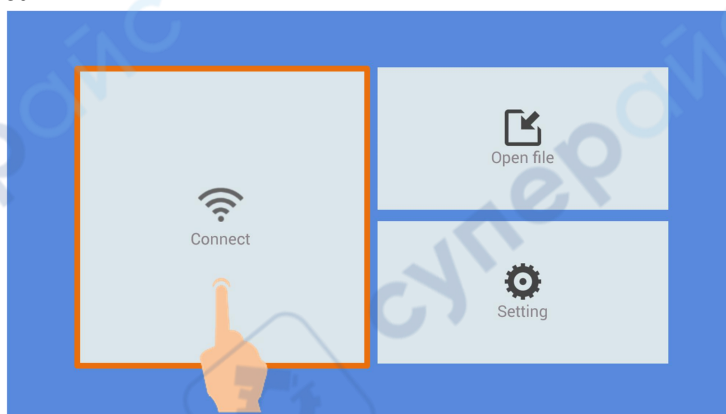
Show password

Show advanced options

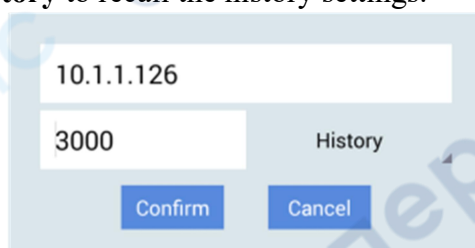
Cancel Connect

(8) In Android device, launch the application.

(9) Click **connect** on the left.



(10) Set **IP** and **Port** to the same value as the setting in the oscilloscope. Click **Confirm** to connect. Click **History** to recall the history settings.

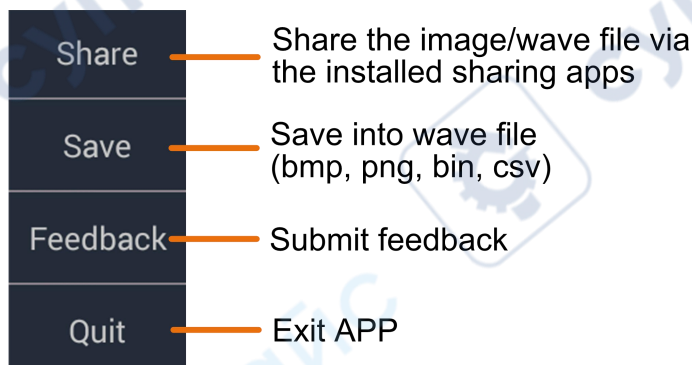
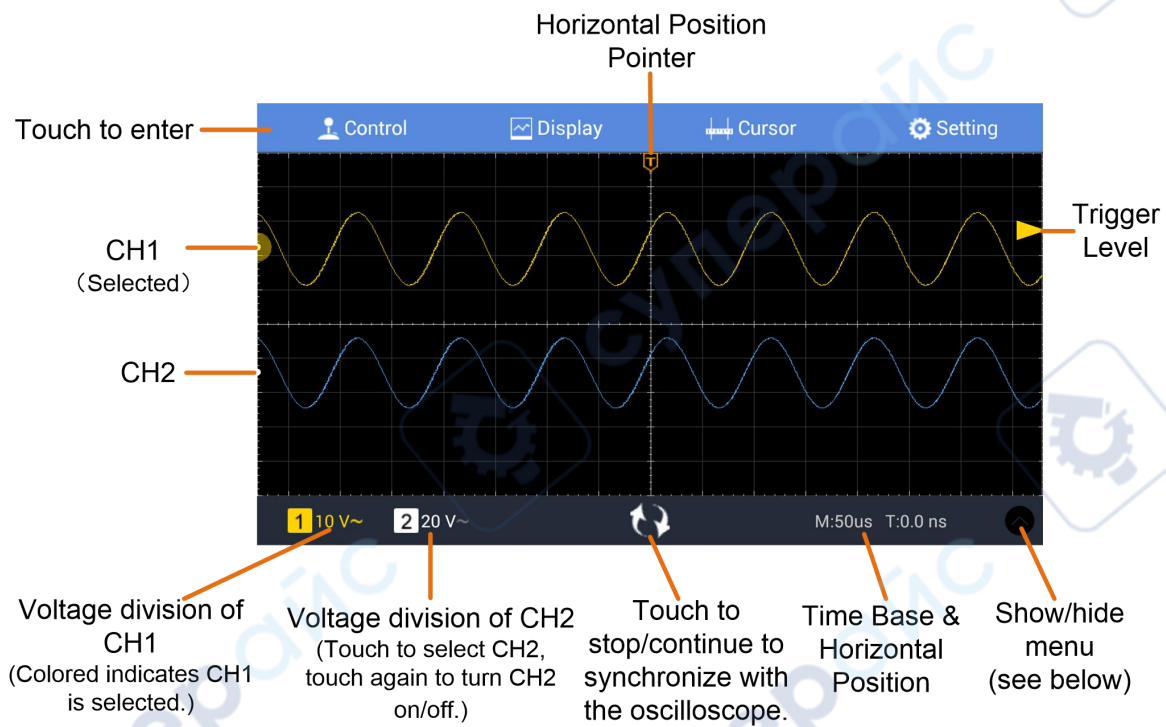


10.1.1.126

3000 History

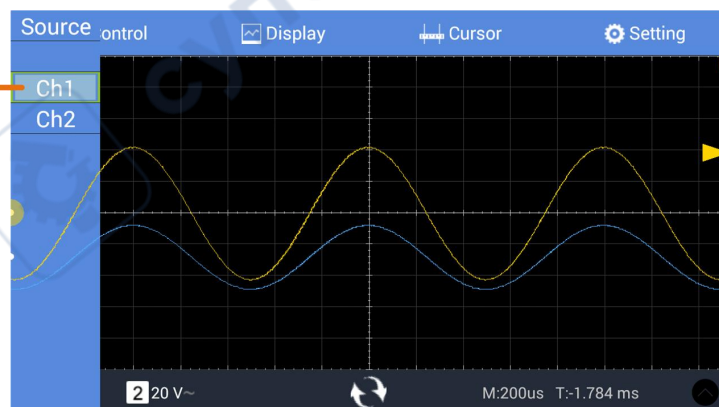
Confirm Cancel

User Interface



Trigger Source Menu

Swipe from the left edge of the screen to show the trigger source menu



Control Menu

Touch to enter the control interface of the generator



Control Interface of the Generator

Turn on/off output of selected channel

Select channel

Select waveform



Set the parameters of current waveform

Display Menu

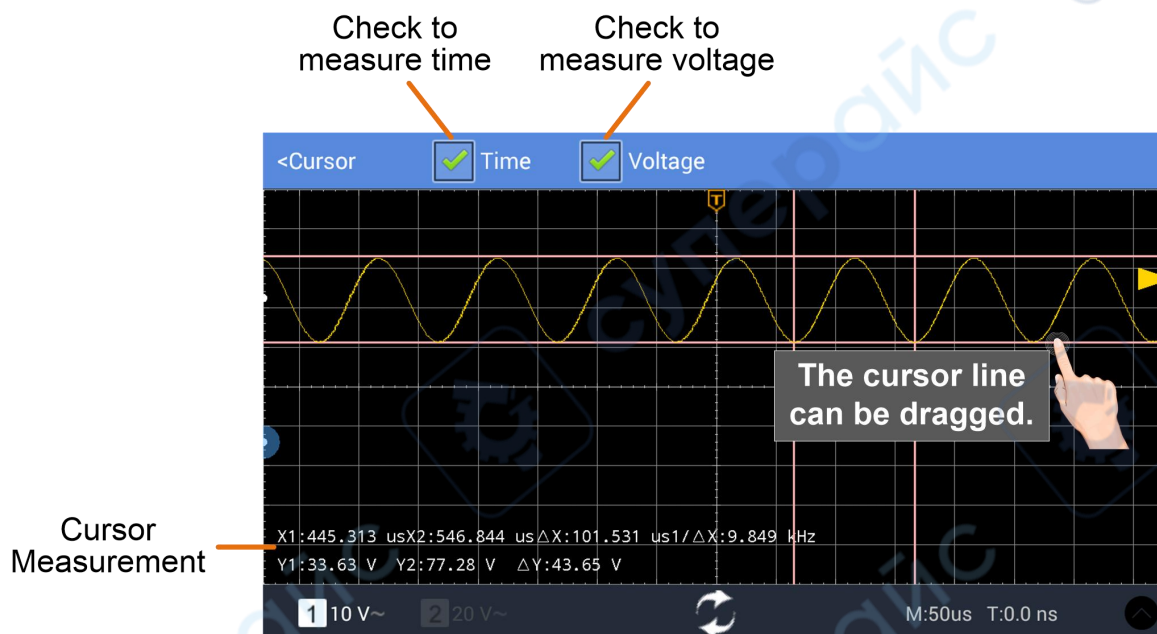
The points will be connected with lines

Adjust the brightness of grid

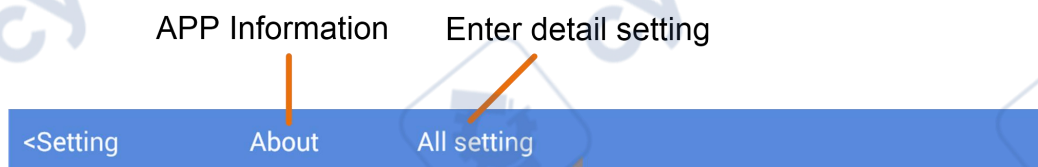
Set the auto measurement



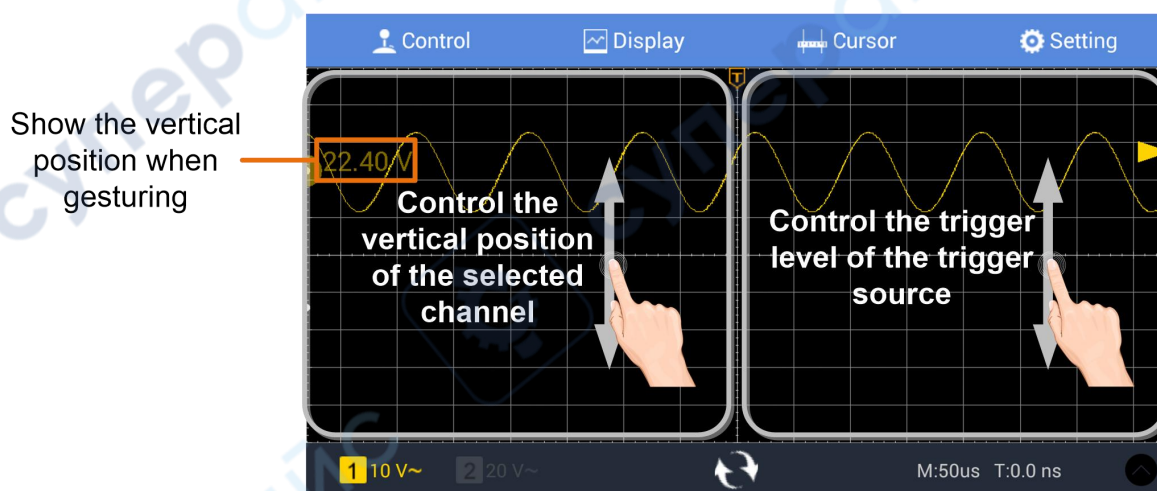
Cursor Menu



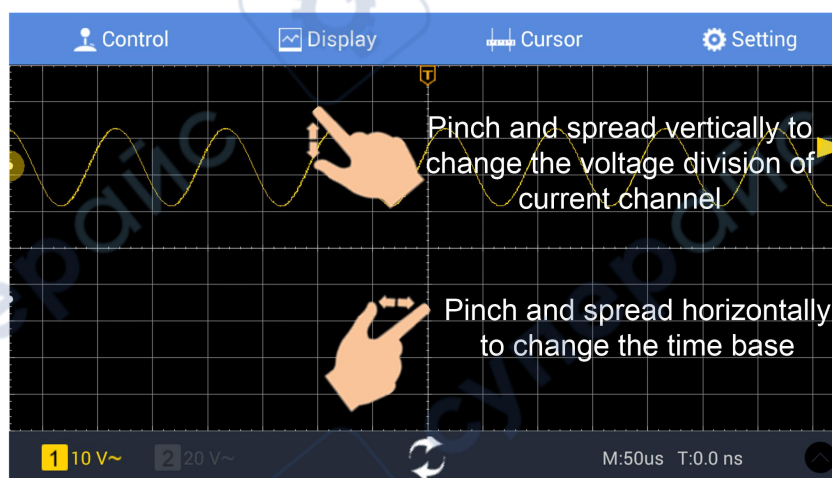
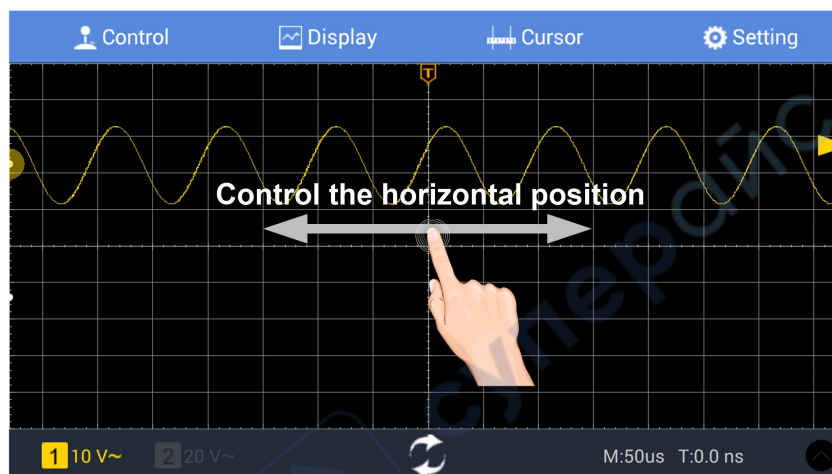
Setting Menu



Gestures Control



8.Communication with Android Device via Wi-Fi (Optional)



9. Demonstration

Example 1: Measurement a Simple Signal

The purpose of this example is to display an unknown signal in the circuit, and measure the frequency and peak-to-peak voltage of the signal.

1. Carry out the following operation steps for the rapid display of this signal:

- (1) Set the probe menu attenuation coefficient as **10X** and that of the switch in the probe switch as **10X** (see "*How to Set the Probe Attenuation Coefficient*" on P12).
- (2) Connect the probe of **Channel 1** to the measured point of the circuit.
- (3) Push the **Autoset** button.

The oscilloscope will implement the **Autoset** to make the waveform optimized, based on which, you can further regulate the vertical and horizontal divisions till the waveform meets your requirement.

2. Perform Automatic Measurement

The oscilloscope can measure most of the displayed signals automatically. To measure the period, the frequency of the CH1, following the steps below:

- (1) Push the **Measure** button to show the Measure menu.
- (2) Select **Add** in the bottom menu.
- (3) In the right menu, select **CH1** in the **Source** menu item.
- (4) In the left Type menu, turn the **M** knob to select **Period**.
- (5) In the right menu, select **Add**. The period type is added.
- (6) In the left Type menu, turn the **M** knob to select **Frequency**.
- (7) In the right menu, select **Add**. The frequency type is added.

The measured value will be displayed at the bottom left of the screen automatically (see *Figure 9-1*).

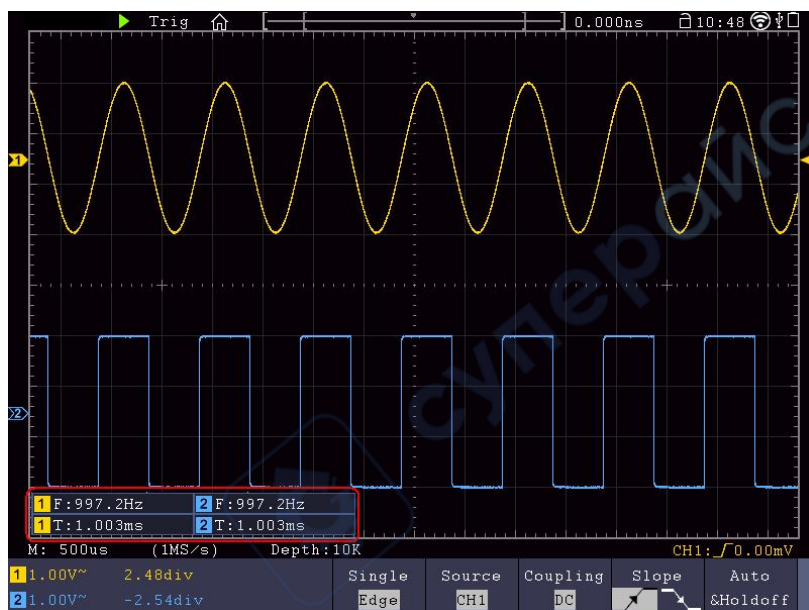


Figure 9- 1 Measure period and frequency value for a given signal

Example 2: Gain of a Amplifier in a Metering Circuit

The purpose of this example is to work out the Gain of an Amplifier in a Metering Circuit. First we use Oscilloscope to measure the amplitude of input signal and output signal from the circuit, then to work out the Gain by using given formulas.

Set the probe menu attenuation coefficient as **10X** and that of the switch in the probe as **10X** (see "*How to Set the Probe Attenuation Coefficient*" on P12).

Connect the oscilloscope CH1 channel with the circuit signal input end and the CH2 channel to the output end.

Operation Steps:

- (1) Push the **Autoset** button and the oscilloscope will automatically adjust the waveforms of the two channels into the proper display state.
- (2) Push the **Measure** button to show the Measure menu.
- (3) Select **Add** in the bottom menu.
- (4) In the right menu, select **CH1** in the **Source** menu item.
- (5) In the left Type menu, turn the **M** knob to select **PK-PK**.
- (6) In the right menu, select **Add**. The peak-to-peak type of CH1 is added.
- (7) In the right menu, select **CH2** in the **Source** menu item.
- (8) In the left Type menu, turn the **M** knob to select **PK-PK**.
- (9) In the right menu, select **Add**. The peak-to-peak type of CH2 is added.
- (10) Read the peak-to-peak voltages of Channel 1 and Channel 2 from the bottom left of the screen (see *Figure 9-2*).
- (11) Calculate the amplifier gain with the following formulas.

Gain = Output Signal / Input signal

Gain (db) = 20×log (gain)

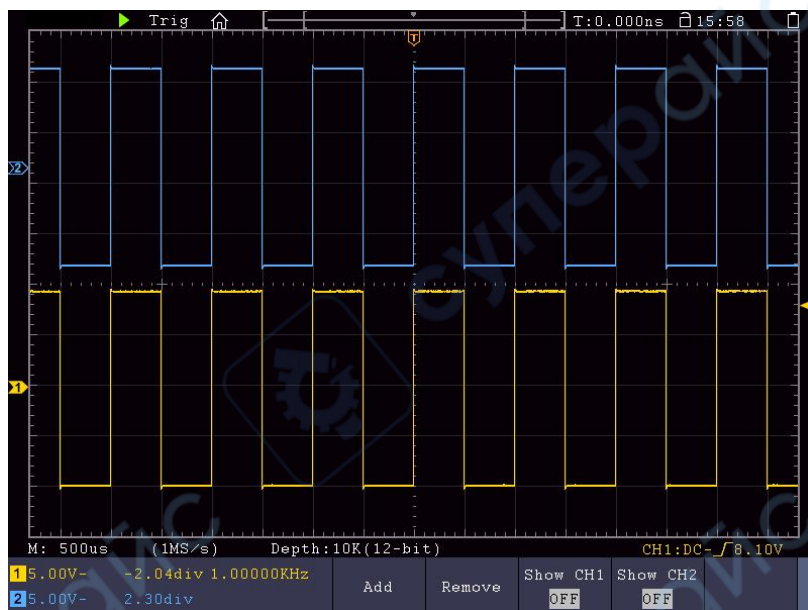



Figure 9-2 Waveform of Gain Measurement

Example 3: Capturing a Single Signal

It's quite easy to use Digital Oscilloscope to capture non-periodic signal, such as a pulse and burr etc. But the common problem is how to set up a trigger if you have no knowledge of the signal? For example, if the pulse is the logic signal of a TTL level, the trigger level should be set to 2 volts and the trigger edge be set as the rising edge trigger. With various functions supported by our Oscilloscope, user can solve this problem by taking an easy approach. First to run your test using auto trigger to find out the closest trigger level and trigger type, this helps user to make few small adjustments to achieve a proper trigger level and mode. Here is how we achieve this.

The operation steps are as follows:

- (1) Set the probe menu attenuation coefficient to 10X and that of the switch in the probe to 10X (see "*How to Set the Probe Attenuation Coefficient*" on P12).
- (2) Adjust the **Vertical Scale** and **Horizontal Scale** knobs to set up a proper vertical and horizontal ranges for the signal to be observed.
- (3) Push the **Acquire** button to display the Acquire menu.
- (4) Select **Acqu Mode** in the bottom menu. Select **Peak Detect** in the right menu.
- (5) Push the **Trigger Menu** button to display the Trigger menu.
- (6) Select the first menu item in the bottom menu. Select **Single** in the right menu.
- (7) In the left menu, select **Edge** as the mode.
- (8) Select **Source** in the bottom menu. Select **CH1** in the right menu.

- (9) Select **Coupling** in the bottom menu. Select **DC** in the right menu.
- (10) In the bottom menu, select **Slope** as  (rising).
- (11) Turn the **Trigger Level** knob and adjust the trigger level to the roughly 50% of the signal to be measured.
- (12) Check the Trigger State Indicator on the top of the screen, if it is not Ready, push down the **Run/Stop** button and start acquiring, wait for trigger to happen. If a signal reaches to the set trigger level, one sampling will be made and then displayed in the screen. By using this approach, a random pulse can be captured easily. For instance, if we want to find a burst burr of high amplitude, set the trigger level to a slightly higher value of the average signal level, push the **Run/Stop** button and wait a trigger. Once there is a burr occurring, the instrument will trigger automatically and record the waveform during the period around the trigger time. By turning the **Horizontal Position** knob in the horizontal control area in the panel, you can change the horizontal triggering position to obtain the negative delay, making an easy observation of the waveform before the burr occurs (see *Figure 9-3*).

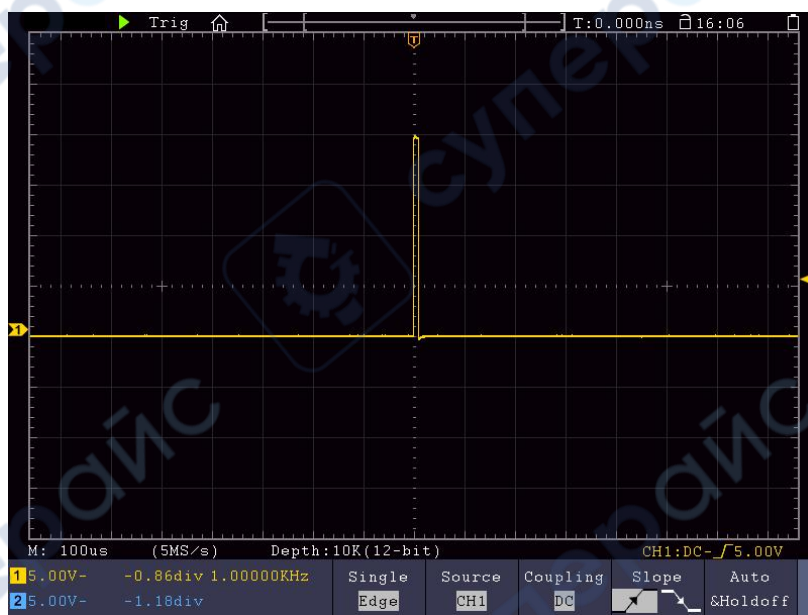


Figure 9-3 Capturing a Single Signal

Example 4: Analyze the Details of a Signal

Noise is very common inside most of the electronic signal. To find out what's inside the noise and reduce the level of noise is very important function our oscilloscope is capable to offer.

Noise Analysis

The level of noise sometime indicates a failure of electronic circuit. The Peak Detect functions acts an important role to help you to find out the details of these noise. Here is how we do it:

- (1) Push the **Acquire** button to display the Acquire menu.
- (2) Select **Acqu Mode** in the bottom menu.
- (3) Select **Peak Detect** in the right menu.

The signal displayed on the screen containing some noise, by turning on Peak Detect function and changing time base to slow down the incoming signal, any peaks or burr would be detected by the function (see *Figure 9-4*).

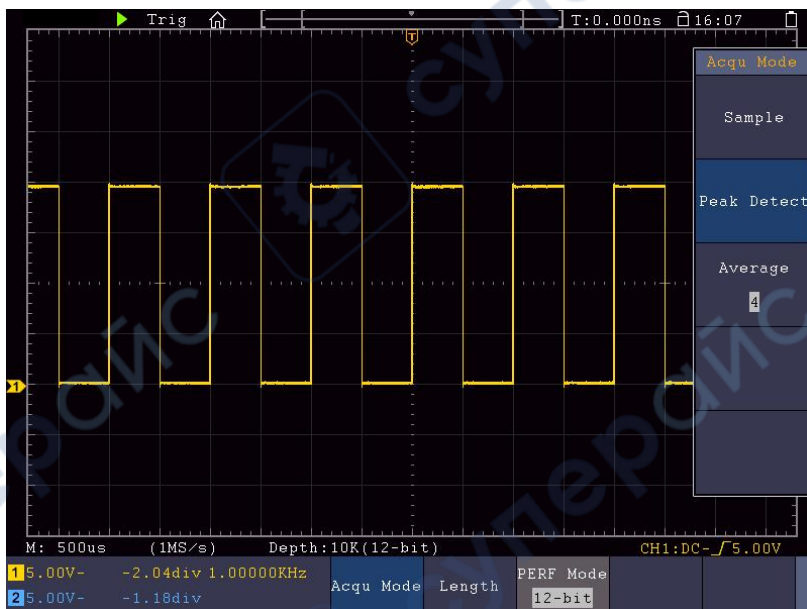


Figure 9-4 Signal with Noises

Separate Noises from the Signal

When focusing on signal itself, the important thing is to reduce the noise level as lower as possible, this would enable user to have more details about the signal. The Average function offered by our Oscilloscope can help you to achieve this.

Here are the steps for how to enable Average function.

- (1) Push the **Acquire** button to display the Acquire menu.
- (2) Select **Acqu Mode** in the bottom menu.
- (3) Select **Average** in the right menu, turn the **M** knob and observe the waveform obtained from averaging the waveforms of different average number.

User would see a much reduced random noise level and make it easy to see more details of the signal itself. After applying Average, user can easily identify the burrs on the rising and falling edges of some part of the signal (see *Figure 9-5*).

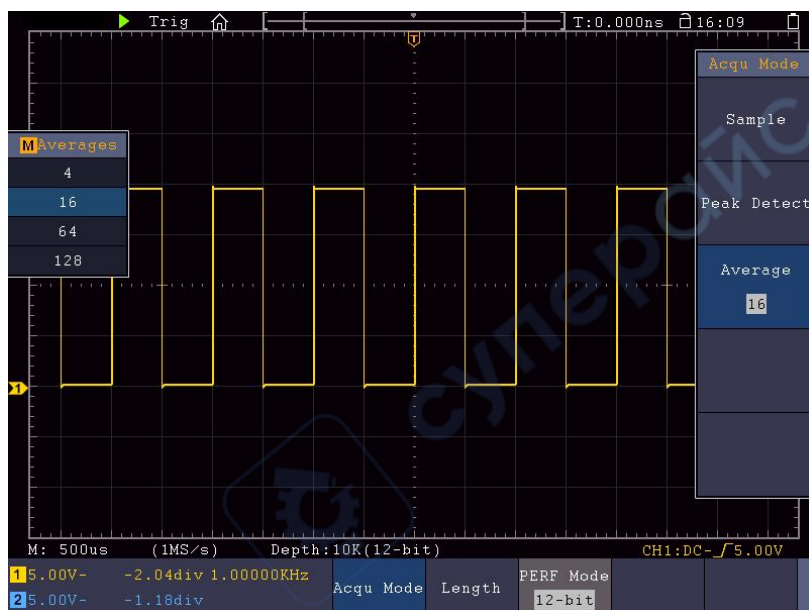


Figure 9-5 Reduce Noise level by using Average function

Example 5: Application of X-Y Function

Examine the Phase Difference between Signals of two Channels

Example: Test the phase change of the signal after it passes through a circuit network.

X-Y mode is a very useful when examining the Phase shift of two related signals. This example takes you step by step to check out the phase change of the signal after it passes a specified circuit. Input signal to the circuit and output signal from circuit are used as source signals.

For the examination of the input and output of the circuit in the form of X-Y coordinate graph, please operate according to the following steps:

- (1) Set the probe menu attenuation coefficient for **10X** and that of the switch in the probe for **10X** (see "How to Set the Probe Attenuation Coefficient" on P12).
- (2) Connect the probe of channel 1 to the input of the network and that of Channel 2 to the output of the network.
- (3) Push the **Autoset** button, with the oscilloscope turning on the signals of the two channels and displaying them in the screen.
- (4) Turn the **Vertical Scale** knob, making the amplitudes of two signals equal in the rough.
- (5) Push the **Display** button and recall the Display menu.
- (6) Select **XY Mode** in the bottom menu. Select **Enable** as **ON** in the right menu. The oscilloscope will display the input and terminal characteristics of the network in the Lissajous graph form.
- (7) Turn the **Vertical Scale** and **Vertical Position** knobs, optimizing the waveform.

- (8) With the elliptical oscillogram method adopted, observe and calculate the phase difference (see *Figure 9-6*).

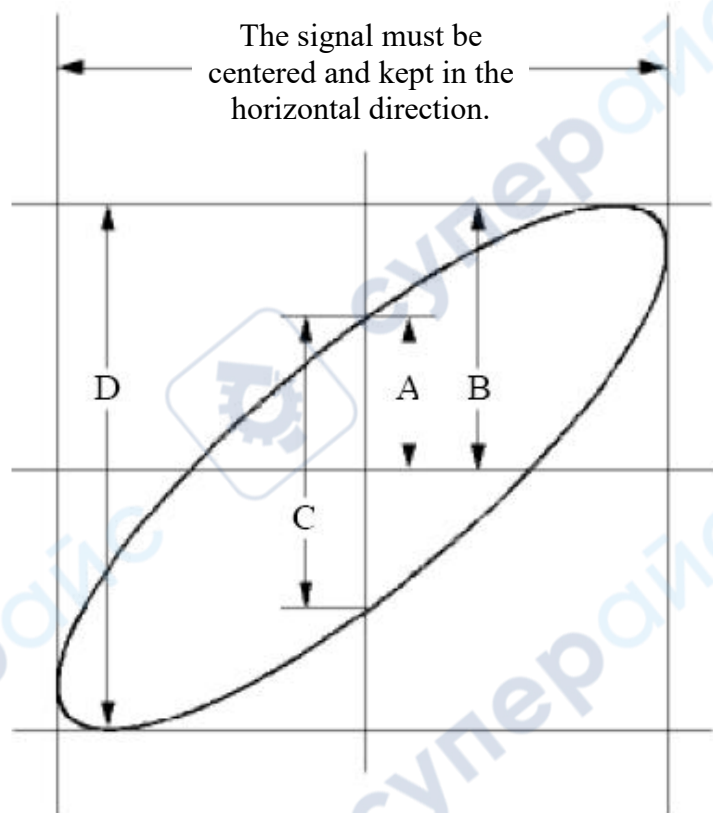


Figure 9-6 Lissajous Graph

Based on the expression $\sin(\varphi) = A/B$ or C/D , thereinto, φ is the phase difference angle, and the definitions of A, B, C, and D are shown as the graph above. As a result, the phase difference angle can be obtained, namely, $\varphi = \pm \arcsin(A/B)$ or $\pm \arcsin(C/D)$. If the principal axis of the ellipse is in the I and III quadrants, the determined phase difference angle should be in the I and IV quadrants, that is, in the range of $(0 - \pi/2)$ or $(3\pi/2 - 2\pi)$. If the principal axis of the ellipse is in the II and IV quadrants, the determined phase difference angle is in the II and III quadrants, that is, within the range of $(\pi/2 - \pi)$ or $(\pi - 3\pi/2)$.

Example 6: Video Signal Trigger

Observe the video circuit of a television, apply the video trigger and obtain the stable video output signal display.

Video Field Trigger

For the trigger in the video field, carry out operations according to the following steps:

- (1) Push the **Trigger Menu** button to display the trigger menu.
- (2) Select the first menu item in the bottom menu. Select **Single** in the right menu.

- (3) In the left menu, select **Video** as the mode.
- (4) Select **Source** in the bottom menu. Select **CH1** in the right menu.
- (5) Select **Modu** in the bottom menu. Select **NTSC** in the right menu.
- (6) Select **Sync** in the bottom menu. Select **Field** in the right menu.
- (7) Turn the **Vertical Scale**, **Vertical Position** and **Horizontal Scale** knobs to obtain a proper waveform display (see *Figure 9-7*).

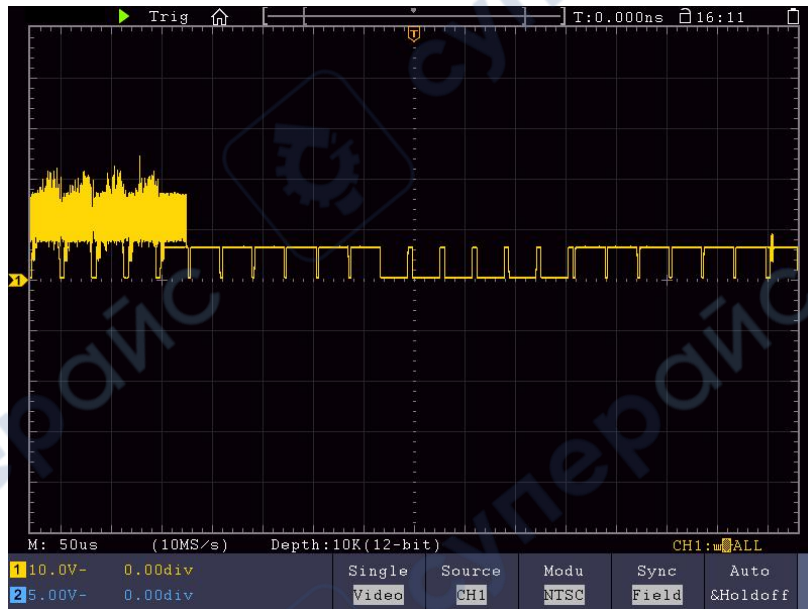


Figure 9-7 Waveform Captured from Video Field Trigger

10. Troubleshooting

1. Oscilloscope is powered on but no Display.

- Check whether the power connection is connected properly.
- Check whether the fuse which is beside the AC power input jack is blew (the cover can be pried open with a straight screwdriver).
- Restart the instrument after completing the checks above.
- If the problem persists, please contact us and we will be under your service.

2. After acquiring the signal, the waveform of the signal is not displayed in the screen.

- Check whether the probe is properly connected to the signal connecting wire.
- Check whether the signal connecting wire is correctly connected to the BNC (namely, the channel connector).
- Check whether the probe is properly connected with the object to be measured.
- Check whether there is any signal generated from the object to be measured (the trouble can be shot by the connection of the channel from which there is a signal generated with the channel in fault).
- Make the signal acquisition operation again.

3. The measured voltage amplitude value is 10 times or 1/10 of the actual value.

Look at the attenuation coefficient for the input channel and the attenuation ration of the probe, to make sure they are match (see "*How to Set the Probe Attenuation Coefficient*" on P12).

4. There is a waveform displayed, but it is not stable.

- Check whether the **Source** item in the **TRIG MODE** menu is in conformity with the signal channel used in the practical application.
- Check on the trigger **Type** item: The common signal chooses the **Edge** trigger mode for **Type** and the video signal the **Video**. If Alternate trigger is selected, both of the channel 1 and channel 2 trigger levels should be adjusted to the proper position. Only if a proper trigger mode is applied, the waveform can be displayed steadily.
- Try to change the trigger coupling into the high frequency suppress and the low frequency suppress to smooth the high frequency or low frequency noise triggered by the interference. (Only for the models that have this function.)

5. No Display Responses to the Push-down of Run/Stop.

Check whether Normal or Single is chosen for Polarity in the TRIG MODE menu and the trigger level exceeds the waveform range.

If it is, make the trigger level is centered in the screen or set the trigger mode as Auto. In addition, with the **Autoset** button pressed, the setting above can be completed automatically.

6. The displaying of waveform seems getting slow after increasing AVERAGE value in Acqu Mode (see "*How to Implement Sampling Setup*" on P60), or a longer duration is set in the Persist in Display (see "*Persist*" on P63).

It's normal as the Oscilloscope is working hard on many more data points.

11. Technical Specifications

Unless otherwise specified, the technical specifications applied are for XDS3000 dual-channel series only, and Probes attenuation set as 10X. Only if the oscilloscope fulfills the following two conditions at first, these specification standards can be reached.

- This instrument should run for at least 30 minutes continuously under the specified operating temperature.
- If change of the operating temperature is up to or exceeds 5°C, do a "Self-calibration" procedure (see "*How to Implement Self-calibration*" on P14).

All specification standards can be fulfilled, except one(s) marked with the word "Typical".

Oscilloscope

Performance Characteristics	Instruction		
Bandwidth	XDS3062A	60 MHz	
	XDS3102(A) XDS3112	100 MHz	
	XDS3102AP	8 bits mode	100 MHz
		12 bits mode	
		14 bits mode	25 MHz
	XDS3202E	200 MHz	
	XDS3202A	8 bits mode	200 MHz
		12 bits mode	150 MHz
		14 bits mode	20 MHz
	XDS3202	200 MHz	
XDS3302	300 MHz		
Vertical Resolution (A/D)	XDS3062A	12 bits	
	XDS3102A	12 bits	
	XDS3102AP	14 bits	
	XDS3102	8 bits	
	XDS3202E	8 bits	
	XDS3202A	14 bits	
	XDS3112	8 bits	
	XDS3202		
	XDS3302	8 bits	
Channel	2 + 1 (External)		
Waveform Refresh Rate	XDS3102 XDS3102A XDS3202E	56,000 wfms/s	
	XDS3112 XDS3202 XDS3302	68,000 wfms/s	

12.Appendix

Performance Characteristics		Instruction				
		XDS3062A XDS3102AP XDS3202A	75,000 wfms/s			
Multi-level Gray Scale Display & Color Temperature Display (Use gray scale to indicate frequency of occurrence, where frequently occurring waveform are bright.)		XDS3062A XDS3102A	Not support			
		XDS3102AP XDS3102 XDS3112 XDS3202E XDS3202A XDS3202 XDS3302	Support			
		XDS3062A XDS3102A XDS3102 XDS3112 XDS3202E XDS3202 XDS3302	Not support			
		XDS3102AP XDS3202A	Support (the touchscreen should be configured)			
Acquisition	Mode		Normal, Peak detect, Averaging			
	Sample rate (real time)	XDS3062A XDS3102A	Dual CH	500 MS/s		
			Single CH	8 bits mode	1 GS/s	
		12 bits mode		500 MS/s		
		XDS3102		Dual CH	500 MS/s	
			Single CH	1 GS/s		
		XDS3202E	Dual CH	500 MS/s		
			Single CH	1 GS/s		
		XDS3102AP XDS3202A	Dual CH	8 bits mode	1 GS/s	
				12 bits mode	500 MS/s	
				14 bits mode	100 MS/s	
		XDS3112 XDS3202	Single CH	8 bits mode	1 GS/s	
				12 bits mode	500 MS/s	
14 bits mode	100 MS/s					
XDS3302	Dual CH	1.25 GS/s				
	Single CH	2.5 GS/s				

12.Appendix

Performance Characteristics		Instruction			
Input	Input coupling	DC, AC, Ground			
	Input impedance	XDS3062A XDS3102(A) XDS3202E	1 MΩ±2%, in parallel with 15 pF±5 pF		
		XDS3102AP XDS3112 XDS3202(A) XDS3302	1 MΩ±2%, in parallel with 15 pF±5 pF; 50Ω ± 2%		
	Probe attenuation factor	0.001X - 1000X, step by 1 – 2 - 5			
	Max input voltage	1MΩ: ≤300 Vrms; 50Ω: ≤5 Vrms (For certain models)			
	Bandwidth limit	20 MHz, full bandwidth			
	Channel to channel isolation	50Hz: 100 : 1 10MHz: 40 : 1			
	Time delay between channel (typical)	150ps			
Horizontal System	Sampling rate range	XDS3062A XDS3102A	Dual CH	0.05 S/s~500 MS/s	
			Single CH	8 bits mode	0.05 S/s~1 GS/s
		12 bits mode		0.05 S/s~500 MS/s	
		XDS3102		Dual CH	0.05 S/s~500 MS/s
			Single CH	0.05 S/s~1 GS/s	
		XDS3202E	Dual CH	0.05 S/s~500 MS/s	
			Single CH	0.05 S/s~1 GS/s	
		XDS3102AP XDS3202A	Dual CH	8 bits mode	0.05 S/s~1 GS/s
				12 bits mode	0.05 S/s~500 MS/s
				14 bits mode	0.05 S/s~100 MS/s
			Single CH	8 bits mode	0.05 S/s~1 GS/s
				12 bits mode	0.05 S/s~500 MS/s
14 bits mode	0.05 S/s~100 MS/s				
XDS3112 XDS3202	Dual CH	0.05 S/s~1 GS/s			
	Single CH	0.05 S/s~2 GS/s			

12.Appendix

Performance Characteristics		Instruction		
		XDS3302	Dual CH	0.05 S/s~1.25 GS/s
			Single CH	0.05 S/s~2.5 GS/s
	Interpolation	(Sinx)/x, x		
	Max Record length	40M		
	Scanning speed (S/div)	XDS3062A	2ns/div - 1000s/div,	
		XDS3102(A)	step by 1 - 2 - 5	
		XDS3102AP	1ns/div - 1000s/div,	
		XDS3112		
		XDS3202E		
	XDS3202(A)			
XDS3302	step by 1 - 2 - 5			
Sampling rate / relay time accuracy	± 1ppm (Typical, Ta = +25°C)			
Interval(ΔT) accuracy (DC - 100MHz)	Single: ± (1 interval time+1 ppm×reading+0.6 ns); Average>16: ± (1 interval time +1 ppm×reading+0.4 ns)			
Vertical system	Sensitivity	1 mV/div~10 V/div		
	Displacement	XDS3062A	±2 V (1 mV/div – 50 mV/div);	
		XDS3102(A)	±20 V (100 mV/div – 1 V/div);	
	Displacement	XDS3102AP	±200 V (2 V/div – 10 V/div)	
		XDS3202A		
	Displacement	XDS3112	±2 V (1 mV/div – 50 mV/div);	
		XDS3202E	±20 V (100 mV/div – 500 mV/div);	
		XDS3202	±250 V (1 V/div – 10 V/div)	
		XDS3302		
	Analog bandwidth	60 MHz, 100 MHz, 200 MHz, 300 MHz		
Single bandwidth	Full bandwidth			
Low Frequency	≥ 10 Hz (at input, AC coupling, -3 dB)			
Rise time (at input, Typical)	XDS3062A	≤ 5.8 ns		
	XDS3102A	≤ 3.5 ns		
	XDS3112			
	XDS3102AP	8 bits mode	≤ 3.5 ns	
		12 bits mode		
		14 bits mode		≤ 14 ns
	XDS3102	≤ 3.5 ns		
	XDS3202E	≤ 1.75 ns		
XDS3202A	8 bits mode	≤ 1.75 ns		
	12 bits mode	≤ 2.33 ns		
	14 bits mode	≤ 17.5 ns		

11. Technical Specifications

Performance Characteristics		Instruction		
		XDS3202	≤ 1.75 ns	
		XDS3302	≤ 1.17 ns	
	DC gain accuracy	XDS3062A	1 mV	3%
		XDS3102A	2 mV	2%
		XDS3102AP	≥ 5 mV	1.5%
		XDS3202A		
		XDS3102	1 mV	3%
		XDS3112	≥ 2 mV	2%
		XDS3202E		
		XDS3202		
XDS3302				
DC accuracy (average)	Delta Volts between any two averages of ≥16 waveforms acquired with the same scope setup and ambient conditions (ΔV): $\pm(3\% \text{ rdg} + 0.05 \text{ div})$			
Waveform inverted ON/OFF				
Measurement	Cursor	ΔV , ΔT , $\Delta T \& \Delta V$ between cursors, auto cursor		
	Automatic	Period, Frequency, Mean, PK-PK, RMS, Max, Min, Top, Base, Amplitude, Overshoot, Preshoot, Rise Time, Fall Time, +Pulse Width, -Pulse Width, +Duty Cycle, -Duty Cycle, Delay A→B φ , Delay A→B ψ , Cycle RMS, Cursor RMS, Screen Duty, Phase, +Pulse Count, FRR, FRF, FFR, FFF, LRR, LRF, LFR, LFF, -Pulse Count, Rise Edge Count, Fall Edge Count, Area, and Cycle Area		
	Waveform Math	+, -, *, /, FFT, FFTrms, Intg, Diff, Sqrt, User Defined Function, digital filter (low pass, high pass, band pass, band reject)		
	Decoding Type (optional)	RS232, I2C, SPI, CAN		
	Waveform storage	100 waveforms		
	Lissajous figure	Bandwidth	Full bandwidth	
Phase difference		±3 degrees		
Communication port	Standard	USB, USB Host (USB storage) ; Trig Out(P/F); LAN port		
	Optional	VGA port and AV port		
Counter	Support			

Trigger

Performance Characteristics		Instruction					
Trigger level range	Internal	± 5 div from the screen center					
	EXT	± 2 V					
	EXT/5	± 10 V					
Trigger level Accuracy (typical)	Internal	± 0.3 div					
	EXT	$\pm (10 \text{ mV} + 6\% \text{ of Set Value})$					
	EXT/5	$\pm (50 \text{ mV} + 6\% \text{ of Set Value})$					
Trigger displacement	According to Record length and time base						
Trigger Holdoff range	100 ns – 10 s						
50% level setting (typical)	Input signal frequency ≥ 50 Hz						
Edge trigger	slope	Rising, Falling					
Video Trigger	Modulation	Support standard NTSC, PAL and SECAM broadcast systems					
	Line number range	1-525 (NTSC) and 1-625 (PAL/SECAM)					
Pulse trigger	Trigger condition	Positive pulse: $>$, $<$, $=$ Negative pulse: $>$, $<$, $=$					
	Pulse Width range	30 ns to 10 s For XDS3102AP/XDS3202A, the range is <table border="1"> <tr> <td>8 bits mode</td> <td>2 ns to 10 s</td> </tr> <tr> <td>12 bits mode</td> <td>4 ns to 10 s</td> </tr> <tr> <td>14 bits mode</td> <td>20 ns to 10 s</td> </tr> </table>	8 bits mode	2 ns to 10 s	12 bits mode	4 ns to 10 s	14 bits mode
8 bits mode	2 ns to 10 s						
12 bits mode	4 ns to 10 s						
14 bits mode	20 ns to 10 s						
Slope Trigger	Trigger condition	Positive pulse: $>$, $<$, $=$ Negative pulse: $>$, $<$, $=$					
	Time setting	30 ns to 10 s For XDS3102AP/XDS3202A, the range is <table border="1"> <tr> <td>8 bits mode</td> <td>2 ns to 10 s</td> </tr> <tr> <td>12 bits mode</td> <td>4 ns to 10 s</td> </tr> <tr> <td>14 bits mode</td> <td>20 ns to 10 s</td> </tr> </table>	8 bits mode	2 ns to 10 s	12 bits mode	4 ns to 10 s	14 bits mode
8 bits mode	2 ns to 10 s						
12 bits mode	4 ns to 10 s						
14 bits mode	20 ns to 10 s						
Runt Trigger	Polarity	Positive, Negative					
	Pulse Width Condition	$>$, $=$, $<$					
	Pulse Width Range	30 ns to 10 s For XDS3102AP/XDS3202A, the range is <table border="1"> <tr> <td>8 bits mode</td> <td>2 ns to 10 s</td> </tr> <tr> <td>12 bits mode</td> <td>4 ns to 10 s</td> </tr> <tr> <td>14 bits mode</td> <td>20 ns to 10 s</td> </tr> </table>	8 bits mode	2 ns to 10 s	12 bits mode	4 ns to 10 s	14 bits mode
8 bits mode	2 ns to 10 s						
12 bits mode	4 ns to 10 s						
14 bits mode	20 ns to 10 s						
Windows Trigger	Polarity	Positive, Negative					
	Trigger Position	Enter, Exit, Time					

11. Technical Specifications

	Windows Time	30 ns to 10 s For XDS3102AP/XDS3202A, the range is <table border="1" style="width: 100%; border-collapse: collapse;"> <tr> <td style="width: 50%;">8 bits mode</td> <td style="width: 50%;">2 ns to 10 s</td> </tr> <tr> <td>12 bits mode</td> <td>4 ns to 10 s</td> </tr> <tr> <td>14 bits mode</td> <td>20 ns to 10 s</td> </tr> </table>	8 bits mode	2 ns to 10 s	12 bits mode	4 ns to 10 s	14 bits mode	20 ns to 10 s
8 bits mode	2 ns to 10 s							
12 bits mode	4 ns to 10 s							
14 bits mode	20 ns to 10 s							
Timeout Trigger	Edge Type	Rising, Falling						
	Idle Time	30 ns to 10 s For XDS3102AP/XDS3202A, the range is <table border="1" style="width: 100%; border-collapse: collapse;"> <tr> <td style="width: 50%;">8 bits mode</td> <td style="width: 50%;">2 ns to 10 s</td> </tr> <tr> <td>12 bits mode</td> <td>4 ns to 10 s</td> </tr> <tr> <td>14 bits mode</td> <td>20 ns to 10 s</td> </tr> </table>	8 bits mode	2 ns to 10 s	12 bits mode	4 ns to 10 s	14 bits mode	20 ns to 10 s
8 bits mode	2 ns to 10 s							
12 bits mode	4 ns to 10 s							
14 bits mode	20 ns to 10 s							
Nth Edge Trigger	Edge Type	Rising, Falling						
	Idle Time	30 ns to 10 s						
	Edge Number	1 to 128						
Logic Trigger	Logic Mode	AND, OR, XNOR, XOR						
	Input Mode	H, L, X, Rising, Falling						
	Output Mode	Goes True, Goes False, Is True >, Is True <, Is True =						
RS232 Trigger	Polarity	Normal, Inverted						
	Trigger Condition	Start, Error, Check Error, Data						
	Baud Rate	Common, Custom						
	Data Bits	5 bit, 6 bit, 7 bit, 8 bit						
I2C Trigger	Trigger Condition	Start, Restart, Stop, ACK Lost, Address, Data, Addr/Data						
	Address Bits	7 bit, 8 bit, 10 bit						
	Address Range	0 to 127, 0 to 255, 0 to 1023						
	Byte Length	1 to 5						
SPI Trigger	Trigger Condition	Timeout						
	Timeout Value	30 ns to 10 s						
	Data Bits	4 bit to 32 bit						
	Data Line Setting	H, L, X						
CAN Trigger (optional)	Signal Type	CAN_H, CAN_L, TX, RX						
	Trigger Condition	Start of Frame, Type of Frame, Identifier, Data, ID & Data, End of Frame, Missing Ack, Bit Stuffing Error						
	Baud Rate	Common, Custom						
	Sample Point	5% to 95%						
	Frame Type	Data, Remote, Error, Overload						

Waveform Generator (Optional)

Performance Characteristics	Instruction
Max Frequency Output	25 MHz
Sample rate	125 MSa/s

11. Technical Specifications

Performance Characteristics	Instruction
Channel	1-CH or 2-CH (optional) Note: Only 2-CH optional AG available for XDS3202(A), XDS3302.
Vertical Resolution	14 bits
Amplitude Range	2 mVpp - 6 Vpp
Waveform length	8K
Standard Waveforms	Sine, Square, Ramp, and Pulse

Multimeter (Optional)

Performance Characteristics	Instruction
Full scale reading	3¾ digits (Max 4000 – count)
Diode	0 V - 1 V
Input impedance	10 MΩ
On/Off measurement	<50(±30)Ω beeping
Capacitance	51.2nF - 100uF: ±(3%±3 digit)
Voltage	DCV: 400mV, 4V, 40V, 400V, 1000V: ±(1%±1 digit) Max. input: DC 1000V ACV: 400mV, 4V, 40V, 400V: ±(1%±3digit) 750V: ±(1.5%±3digit) Frequency: 40Hz - 400Hz, Max. input: AC 750V (virtual value)
Current	DCA: 40mA, 400mA: ±(1.5%±1 digit) 4A, 10A: ±(3%±3digit) ACA: 40mA: ±(1.5%±3digit) 400mA: ±(2%±1digit) 4A, 10A: ±(3%±3digit)
Impedance	400Ω: ±(1%±3digit) 4KΩ~4MΩ: ±(1%±1digit) 40MΩ: ±(1.5%±3digit)

General Technical Specifications

Display

Display Type	8" Colored LCD (Liquid Crystal Display)
Display Resolution	800 (Horizontal) × 600 (Vertical) Pixels
Display Colors	65536 colors, TFT screen

Output of the Probe Compensator

Output Voltage (Typical)	About 5 V, with the Peak-to-Peak voltage $\geq 1 \text{ M}\Omega$.
Frequency (Typical)	Square wave of 1 KHz

Power

Mains Voltage	100V - 240 VACRMS, 50/60 Hz, CAT II	
Power Consumption	XDS3062A XDS3102(A) XDS3102AP XDS3112 XDS3202E XDS3202(A) XDS3302	<24 W
Fuse	2 A, T class, 250 V	
Battery (optional)	3.7V, 13200mAh <ul style="list-style-type: none"> ● On XDS3062A, XDS3102(A), the battery can last approximately 3.5 hours after charge fully. ● On XDS3202(E), XDS3302, the battery can last approximately 2.5 hours after charge fully. 	

Environment

Temperature	Working temperature: 0 °C - 40 °C Storage temperature: -20 °C - 60 °C
Relative Humidity	$\leq 90\%$
Height	Operating: 3,000 m Non-operating: 15,000 m
Cooling Method	Fan cooling

Mechanical Specifications

Dimension	340 mm × 177 mm × 90 mm (L*H*W)
Weight	Approx. 2.6 kg (without accessories)

Interval Period of Adjustment:

One year is recommended for the calibration interval period.

12. Appendix

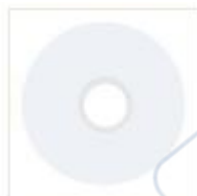
Appendix A: Enclosure

(The accessories subject to final delivery.)

Standard Accessories:



Power Cord



CD Rom



Quick Guide



USB Cable



Probe



Probe Adjust

Options:



Multimeter Lead



Q9



Capacitance
Ext Module



Battery



Soft Bag

Appendix B: General Care and Cleaning

General Care

Do not store or leave the instrument where the liquid crystal display will be exposed to direct sunlight for long periods of time.

Caution: To avoid any damage to the instrument or probe, do not exposed it to any sprays, liquids, or solvents.

Cleaning

Inspect the instrument and probes as often as operating conditions require.

To clean the instrument exterior, perform the following steps:

1. Wipe the dust from the instrument and probe surface with a soft cloth. Do not make any scuffing on the transparent LCD protection screen when clean the LCD screen.

2. Disconnect power before cleaning your Oscilloscope. Clean the instrument with a wet soft cloth not dripping water. It is recommended to scrub with soft detergent or fresh water. To avoid damage to the instrument or probe, do not use any corrosive chemical cleaning agent.

Warning: Before power on again for operation, it is required to confirm that the instrument has already been dried completely, avoiding any electrical short circuit or bodily injury resulting from the moisture.

Appendix C: Battery Using Guide

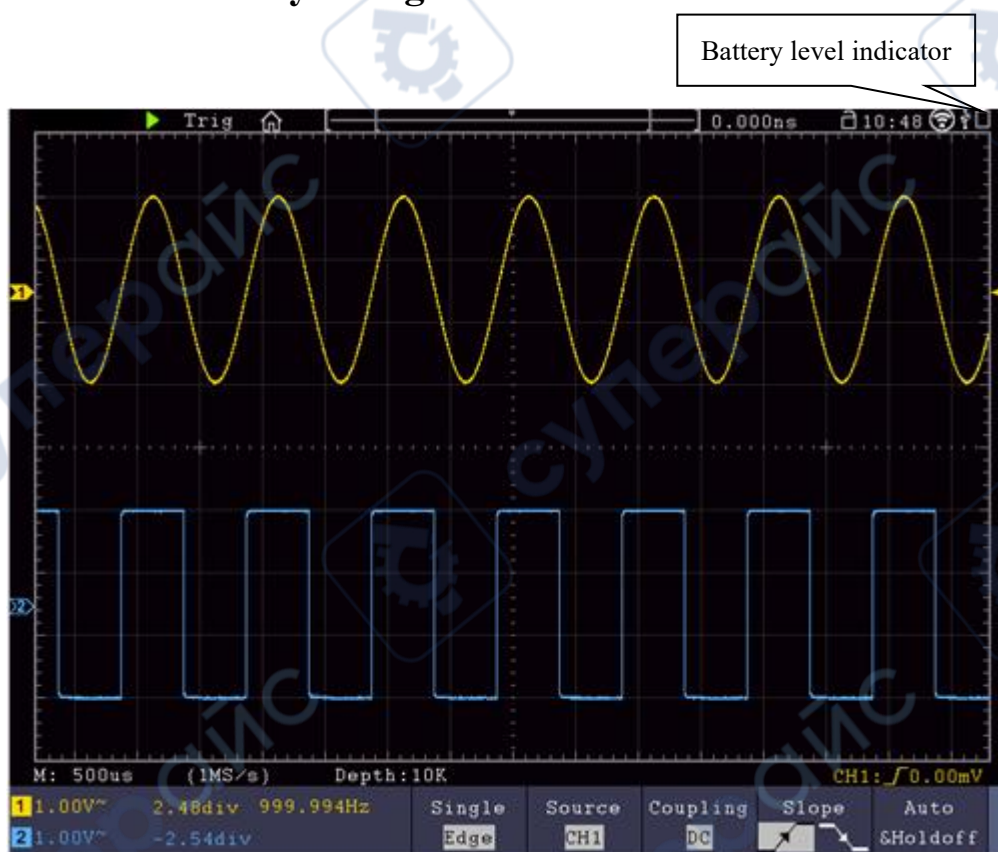


Figure 12- 1 Battery level indicator

Charging the oscilloscope

There will have battery power indication show on the top of panel when oscilloscope power supplied by the battery (if no indication has appeared, see "*Display*" on P80).

□ indicates the battery is nearly used up.

Note:

To avoid overheat of battery during charging, the ambient temperature is not allowed to exceed the permissible value given in technical specification.

Replacing the Lithium Battery Unit

It is usually not required to replace the battery unit. But when it is required to replace it, only qualified personnel can carry out this operation, and only use the same specification lithium battery.