

INFRARED THERMOMETER

- 200°C~1850°C(392°F~3362°F)
- 200°C~2200°C(392°F~3992°F)



OPERATION MANUAL



user's manual



Thanks for your purchasing our product.
Please read this manual carefully before use
and keep it for future reference.

CONTENTS

Before use

1. Check	1
2. Instruction	1
3. Safety instruction	2
4. Discription of parts	4
5. Buttons	4
6. LCD display	5
7. Distance to Spot size	5
8. Emissivity	6

Operation

1. Turn ON/OFF	7
2. Locat hot/cold spot	7
3. Measurement	8
4. Data storage	9
5. Data review	9
6. Data clearance	9
7. Lock / Unlock	9
8. Unit selection	9
9. RS232 connection with PC	9
10. DC IN	9

Specification	10
---------------------	----

Maintenance and warranty

1. Maintenance	11
2. Warranty	13



Before use

1. Check up:

Unpack the box to check if there are articles as below in the package. Contact your local dealer if there is any mismatch, missing, or damage.

Infrared thermometer -----	1 PCS
Software CD -----	1 PCS
9V alkaline battery -----	1 PCS
RS232 connection cable -----	1 PCS
Operation manual -----	1 PCS
Packing box -----	1 PCS

2. Introduction:

This product is used for measuring the temperature of the object's surface quickly and safely, which is applicable for various hot, hazardous or hard-to-reach objects without contact directly.

This unit consists of optics system, photoelectric sensor, signal amplifier, signal process circuit and LCD. The optics system collects the infrared energy emitted by object and focus onto the sensor. Then the sensor translates the energy into electricity signal which will be turned out to be readings shown on the LCD by the signal amplifier and signal process circuit. Equipped with RS232 data export function, this product is surely to be a great help to your work.

SAFETY • PRECISION • DURABLE



3. Safety instruction:

 Warning: please follow the instructions below to avoid possible injury

1. Do not point at people's eye directly or indirectly from a reflective surface;
2. This product can not measure through transparent objects such as glasses or plastics, otherwise the reading may only reflect the surface temperature of the transparent object.
3. Steam, dust, smoke, or other particles impacts the optic lens which will finally result in inaccurate measurement. So do not use the product in such an environment.

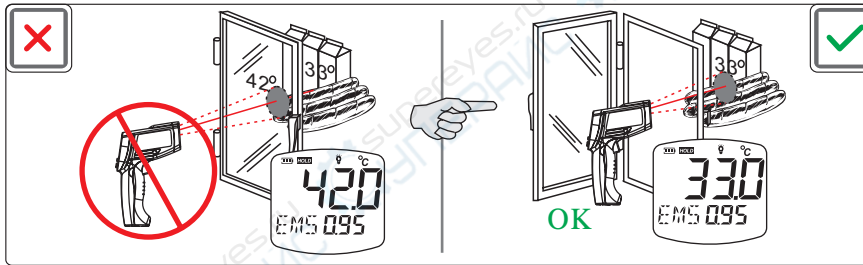
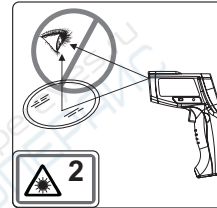

SAFETY ● PRECISION ● DURABLE



 Cautions: Do not use the product in the following environment:

1. EMF (electro-magnetic fields) from arc welders, induction heaters;
2. Gas station, chemical factory, explosive area;
3. Static electricity.



IMPORTANT:

1. This product is of short wave, so please avoid using it under sunlight. If the sunlight is too strong, even the measured is under the measuring range, the product will show a wrong temperature reading.
2. Against the strong bulb light, the product may get 200 to 300 Celsius degree reading, this is normal for the product.
3. Waiting for 30 minutes to measure if there is a thermal shock caused by large or abrupt ambient temperature.
4. Do not make the product too close to your body after long time operation.
5. Do not leave the unit on or near objects of high temperature.
6. Do not dismantle the product without authorization. Contact the local dealer if there is any problem.

SAFETY • PRECISION • DURABLE



4. Discription of parts:

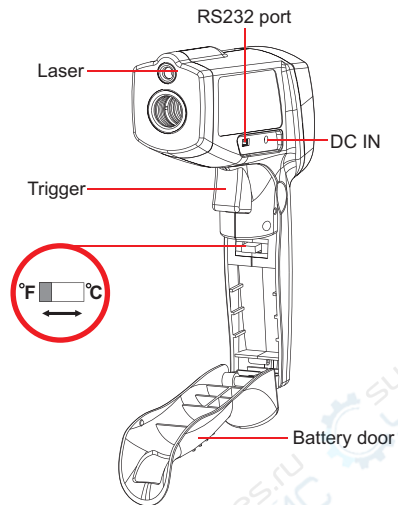

5. Buttons:

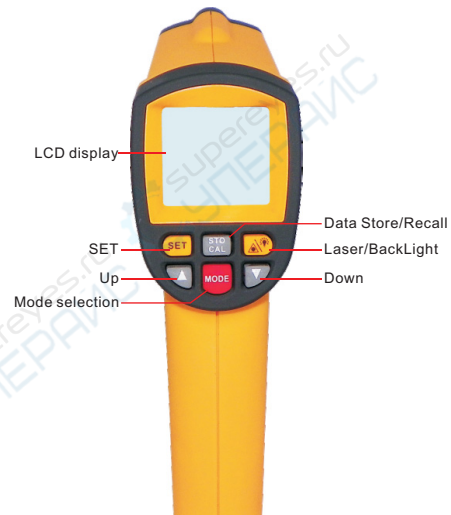



6. LCD display:

- A: Temperature reading
- B: Temperature unit
- C: Laser on icon
- D: Backlight on icon
- E: Battery power icon
- F: Scanning icon
- G: Data hold icon
- H: Mode/emissivity icon
- I: Data store / recall icon
- J: Low temperature alarm icon
- K: High temperature alarm icon

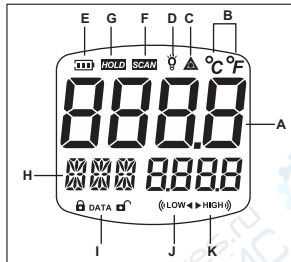

7. Distance to spot size:

1). When take measurement, pay attention to the Distance to Spot Size. As the Distance (D) from the target surface increases, the spot size (S) of measuring area becomes larger.

The Distance to Spot size of the unit is 80:1.

This unit equipped with a laser, which is only used for aiming.

2). Field of view:

Make sure the target is larger than the unit's spot size.

The smaller the target, the smaller measuring distance. When accuracy is critical, make sure the target is at least twice as large as the spot size.

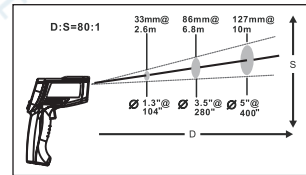



8. Emissivity :

Most organic materials and painted or oxidized surfaces have an emissivity of 0.95(pre-set in the unit).

Set the EMS according to different objects surfaces, please refer to the right table for emissivity of normal materials.

Inaccurate readings will result from measuring shiny or polished metal surfaces.

To compensate for this, adjust the emissivity or cover the surface to be measured with masking tape or flat black paint. Measure the tape or painted surface when they reach the same temperature as the material underneath.

Note:
n.r in the table denotes
NOT RECOMMENDED.

Material	Emissivity	Material	Emissivity		
Aluminum	Non oxidized	0.1-0.2	Molybdenum	Oxidized	0.5-0.9
	Oxidized	0.4		Non oxidized	0.25-0.35
Alloy A3003	Oxidized	n.r	Brass	Polished	0.8-0.95
	Rough	0.2-0.8		Polished	n.r
	Polished	0.1-0.2		Oxidized	0.6
Chrome		0.4	Golden		0.3
	Polished	n.r	Hastelloy	Alloy	0.5-0.9
Copper	Rough	n.r		Oxidized	0.4-0.9
	Oxidized	0.2-0.8	Cr / Ni / Fe Alloy	Sanded	0.3-0.4
	PCB	n.r		Electroplishing	0.2-0.5
	Oxidized	0.4-0.8		Oxidized	0.7-0.9
Iron	Non oxidized	0.35	Cast iron	Non oxidized	0.35
	Rusty	n.r		Melted	0.35
	Melted	0.35	Forge pig	Rough	0.9
	Polished	0.35	Magnesium		0.3-0.8
Aluminum	Rough	0.65	Mercury		n.r
	Oxidized	n.r	Monel alloy(Ni-Cu)		0.3
	Oxidized	0.8-0.9	Platinum	Monel alloy	n.r
Nickel	Electrolytic	0.2-0.4	Silver		n.r
	Cold rolling	0.8-0.9	Stainless steel		0.35
Copper	Polished	n.r	Tin	Non oxidized	0.25
	Polishing plate	0.35	Asbestos		0.9
	Melted	0.35	Ceramics		0.4
	Oxidized	0.8-0.9	Concrete		0.65
	Polished	0.5-0.75	Tungsten		n.r
Titanium	Oxidized	n.r	Carbon	Polished	0.35-0.4
	Oxidized	0.6		Non oxidized	0.8-0.95
Zinc	Polished	0.5	Graphite		0.8-0.9

SAFETY ● PRECISION ● DURABLE



Operation:

1. Turn ON/OFF:

- a. Install / replace battery:
Open the battery door and insert a 9V alkaline battery correctly.
Then close the battery door.
- b. Turn ON/OFF:
Pull the trigger until a “Bi...Bi...” sound appears. The unit turns off automatically if there is no further operation in 30 seconds.

2. Locate hot/cold spot:

To find a hot/cold spot, aim the thermometer outside the area of interest, then scan across with up and down motion until you locate the hot/cold spot. As shown in the following figure:

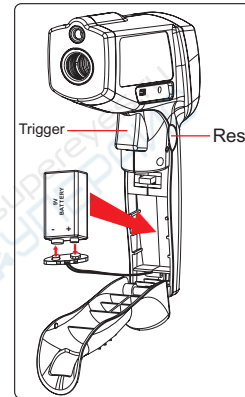
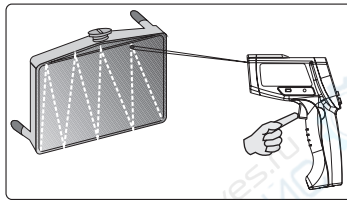

3. Measurement:

- a. Trigger: pull the trigger to turn on, LCD displays VERXX software version for 1 second, and the temperature reading. SCAN and EMS(preset emissivity 0.95) displays at the same time. Release the trigger, the temperature will be held automatically, LCD display the temperature reading and HOLD icon.

SAFETY ● PRECISION ● DURABLE



- b. Laser and backlight ON/OFF: when the backlight turn on, any operation will remain backlight for 7 seconds. LCD indicates laser / backlight ON/OFF status. Press this button again and again will change the status of laser/backlight.
- c. Mode selection: press MODE button, LCD displays in the sequence of PLY-CLR-MAX-MIN-AVG-DIF-HAL-LAL-SNG-EMS(note: under the mode of EMS, HAL and LAL, press the SET button first, when the mode flashes, press up /or down button to set up, finally press SET to confirm)
- d. Illustration of modes:
 - PLY: Replay the stored data. When PLY is selected, press up or down button to Check the data.
 - CLR: CLear stored data. Press STO/CAL button for 2 seconds, the stored data will be all cleared.
 - MAX: Measure maximum temperature.
 - MIN: Measure minimum temperature.
 - Average: Measure average temperature.
 - DIF: Basic on the reading before press SET button compute the difference of current reading.
 - HAL: High temperature alert---when selected HAL, press up or down button to set high temperature alarm trigger and confirmed by pressing SET button. When reading over trigger, LCD display HI icon with BiBi audio sounds.
 - LAL: Low temperature alert--- when selected LAL, press up or down button to set low temperature alarm trigger and confirmed by pressing SET button. When reading over trigger, LCD display LOW icon with BiBi audio sounds.
 - EMS: Adjust the emissivity from 0.1 to 1.0.

SAFETY ● PRECISION ● DURABLE



4. Data storage:

- a. When take measurement, every pressing on STO/CAL button will save a data, which has the max capacity up to 4000 data.
- b. When take measurement, press STO/CAL button and pull the trigger continually allows you to save the sampling data continually.

5. data review:

- a. In PLY mode, press UP/DOWN button to replay the data.
- b. Pressing SET button and UP/DOWN button at one time allows you to review data quickly. Or you may connect the product with PC to export the data.

6. data clearance:

In the CLR mode, pressing STO/CAL button for 2 seconds to clear the stored record.

7. Lock/unlock:

In measuring, pressing on the trigger and the SET button at one time to enter into continuous measuring mode, There is lock icon on the LCD during this operation; press the trigger again to exit continuous measuring mode, There is unlock icon on the LCD during this operation.

8. unit selection:

Open the batter door and slide the switch to change the temperature unit.

9. RS232 connection with PC:

- a. When the product is properly connected with PC, there is DATA displaying on the LCD.
- b. Please refer to the file IRT instructions in the disk included to install the program
- c. Program function: to retrieve data, to save online/offline and data curve analysis

10. DC IN: Use the 9V 500mA DC adaptor to save battery consumption.

SAFETY ● PRECISION ● DURABLE**Specification:**

Specification	1850	2200
Temperature range	200 ~ 1850°C (392 ~ 3362°F)	200 ~ 2200°C (392 ~ 3992°F)
Accuracy	200°C(392°F)~ 450°C(842°F): ±2°C or ±2% 450°C(842°F)~ 1100°C(2012°F): ±3°C or ±3% 1100°C(2012°F)~ 1850°C(3362°F): ±4°C or ±3% whichever is bigger	200°C(392°F)~ 450°C(842°F): ±2°C or ±2% 450°C(842°F)~ 1100°C(2012°F): ±3°C or ±3% 1100°C(2012°F)~ 2200°C(3992°F): ±4°C or ±3% whichever is bigger
Repeatability	1% of reading or 1°C	1% of reading or 1°C
Time response	500 mSec, 95% response	500 mSec, 95% response
Spectral response	900~1700 nm	900~1700 nm
Emissivity	0.10-1.00adjustable (pre-set 0.95)	0.10-1.00adjustable (pre-set 0.95)
Ambient operation range	0 ~40°C (32 ~ 104°F)	0 ~40°C (32 ~ 104°F)
Relative humidity	10-80% RH noncondensing	10-80% RH noncondensing
Storage	-20 ~ 60°C (-4~140°F)≤85%, without battery	-20 ~ 60°C (-4~140°F)≤85%, without battery
Weight / Size	270G(without battery) ; 141 x 60 x 220mm	270G(without battery) ; 141 x 60 x 220mm
Power	9V Alkaline battery or 9V 500mA DC IN	9V Alkaline battery or 9V 500mA DC IN
Battery life(alkaline)	Laser Models:10 hrs	Laser Models:10 hrs
Distance to spotsize	80:1	80:1



Maintenance and warranty:

1. Maintenance:

- a. In operation, if there is an icon  appears, please replace the battery.
- b. Take out the battery if the product will not be used for a long time..
- c. Gently brush the lens with alcohol cotton cloth.
- d. Use moist cotton cloth to clean the surface of the product.

Do not submerge the product in water. Do not clean the product with erosive or volatile solvent.

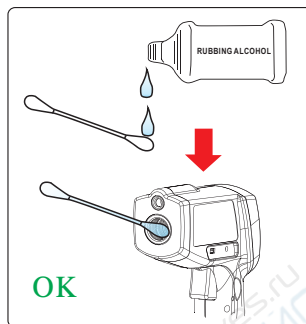



WARNING:

- a. Do not deal with the scraped battery as the normal family garbage. Please comply with the local law to deal with the battery used.
- b. Though this product meets the requirements and standards of electromagnetic compatibility, the radiation interfere with other instruments.
- c. All users must operate the product in compliance with the manual. The user holds the responsibility as below:
 - Totally understanding all the safety note and contents in the manual;
 - Fully acknowledge to the local law and rules;
 - Contacting local dealer immediately if there is any problem of the product.
- e. A mistake turnout may come out if you use a malfunction product or impacted product. Please regularly check up the instrument especially when the product is after abnormal use or important measurement.
- f. Our company reserves the right to change the design of the product and the manual without further notification.



2. Warranty:

- a. Please refer to the warranty card for maintenance possible.
- b. Our company refuses to offer service in the following cases:
 - unauthorized dismantling of the product;
 - mistake transport or storage after purchase;
 - damages resulting from abuse and/or mistake operation in breach of the manual;
 - unauthorized changing the record on the guarantee card;
 - failure of presenting purchase invoice
- c. our company offers one year guarantee based on the compliance of the conditions above.

SAFETY • PRECISION • DURABLE

CE FC

Version:
1850/2200-EN-00

