



MODEL: GT3251

Infrared Thermal Imager Instruction Manual



Version:3251-EN-00

— 1 —

I. Precautions

1. Do not assemble or disassemble this product without authorization. If you need to repair or maintain the product of precision, please refer to the professionals authorized.
2. Do not use abrasives, isopropanol or gaseous organic solvents to clean the product's shell, otherwise it may damage the shell in which case the product cannot be put into use anymore.
3. If smoke, sparks, or scorched odor is detected during operation, please stop using it immediately.
4. Do not place this product in dusty, humid and high-temperature places.
5. Please use a charger that meets specifications, otherwise the product may be damaged.
6. If you store the instrument with batteries for a long time, please charge it regularly, otherwise the power will be exhausted and battery life will be shortened.

II. Introduction

Infrared thermal imager is an instrument that uses thermal imaging technology to measure temperature and observe heat distribution on the surface of natural objects. It is convenient to perform real-time detection under high-voltage, high-current, and high-speed state to find potential problems and prevent failures. This "non-contact" modern detection technology is safe, fast and reliable.

Infrared thermal imaging detection technology is widely used in the following fields:

1. Power equipment, transmission and transformer circuit inspection;
2. Hidden fire source search during fire fighting;
3. Personnel search and rescue in the fire, and direction at fire scene;
4. Analyze location of leakage points and heat loss of thermal pipelines and heating equipment;
5. Determine the location of heating failure on operating train;
6. Nightly monitor for security department.

III. Features

1. Infrared temperature measurement, fast, safe and reliable;
2. Display temperature value, maximum value and minimum value of center point of temperature measurement area;
3. USB charging;
4. Adjustable color palette;
5. Data storage;
6. Automatic shutdown;
7. Multiple language options;
8. Selection of temperature units: °C/°F;
9. Flashlight: highlight LED;
10. Camera

— 2 —

IV. Components and functions

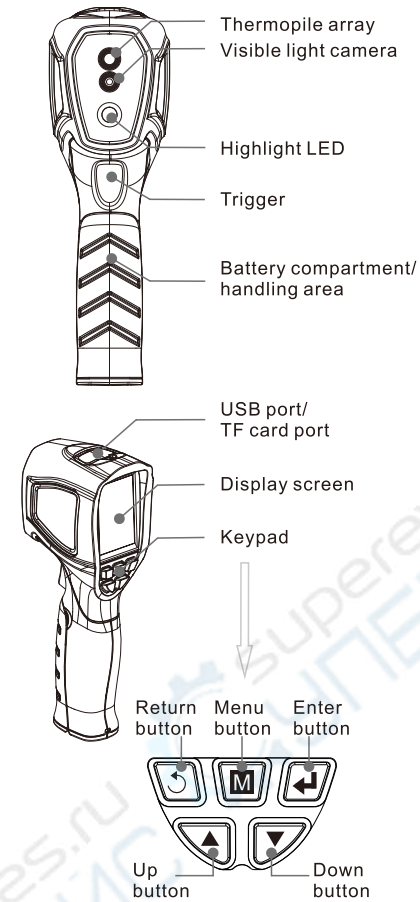

— 3 —

| | | |
|--|---------------|---|
| | Return button | Exit or return to the previous menu |
| | Menu button | Press menu button on main interface ^[1] to display main menu. |
| | Enter button | Main interface: Long press it to turn on/off flashlight; Main menu: short press it to confirm |
| | Up button | Main interface: Press Up button to switch display modes; Other function: add when entering numbers |
| | Down button | Main interface: Press Down button to quickly switch palette; Other function: Subtract when entering numbers |
| | Trigger | If the instrument is shut down, short pull the trigger to turn it on; If the instrument is on, short pull the trigger to take pictures, long pull the trigger to shut down the instrument |

[1]Main interface is the interface after startup

V. Technical parameters

| | |
|------------------------------------|--|
| Temperature range | -20 ~ 400°C (-4 ~ 752°F) |
| Basic accuracy | 0 ~ 400°C (32 ~ 752°F) : ±1.8% or ±1.8°C (±3.2°F) -20 ~ 0°C (-4 ~ 32°F) : ±3°C (±5°F) |
| Thermal imaging resolution | 32*32 |
| Enhanced pixels | 320*240 |
| Emissivity | Preset 0.95, 0.1~0.99 adjustable |
| Visible light camera | 2 million pixels |
| Display modes | Thermal imaging, thermal mixing, digital camera, edge detection line |
| Color palette | Iron red, color, black and white |
| Wavelength range | 8~14μm |
| Field of view (FOV) | 33°horizontal |
| Instantaneous field of view (IFOV) | 18mrad |
| Thermal imaging sensitivity | 150mk |
| Frame rate | ≤9Hz |
| Saved image format | Bitmap (BMP) image |
| Display type | 2.4" TFT LCD |
| Display resolution | 320*240 pixels |
| Storage card | 8GB mini TF card |
| Language | English, French, German, Russian, Spanish, Chinese |
| Automatic shutdown | 3 mins no operation |
| Working temperature | -10 ~ 45°C (14 ~ 113°F) |
| Power supply | 3.7V/2600mAh rechargeable batteries |
| Continuous usage time of batteries | ≥4hours |
| Product dimensions | 202.0*64.3*77.6mm |
| Weight | 254g(including batteries) |

— 4 —

VI. Operation instructions

*The following operations are based on main interface after startup (Figure 1), and main menu by pressing menu button(Figure 2).

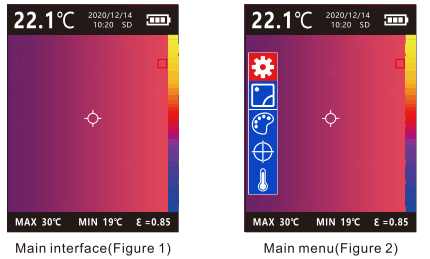

Main interface(Figure 1)

Main menu(Figure 2)

1. System settings (Figure 3):

After entering main menu, press Up/Down button to choose and press enter button for "Settings".

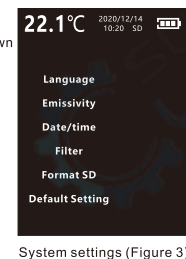

System settings (Figure 3)

(1) Language (Figure 4):

Press Up/Down button to choose "Language", press enter button for language selection, press Up/Down button to select language, press enter button to save and exit.

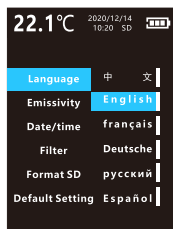

Language (Figure 4)

(2) Emissivity (Figure 5):

Press Up/Down button to choose "emissivity", press enter button to modify emissivity, and press Up/Down button to increase/decrease value; press enter button again to save and exit.

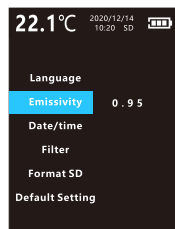

Emissivity (Figure 5)

(3) Date and time (Figure 6):

Press Up/Down button to set "Date/time", press enter button for modification, press Up/Down button to increase/decrease value, and press enter button again to switch in turn: year-month-day-hour-minute-time system (00/01/01 00:00 12/24 hour), after all settings are completed, short press Return button to save and exit.

(4) Filter (Figure 7):

Press Up/Down button to select "Filter", press enter button for modification, press Up/Down button to select ON/OFF; press enter button again to save and exit.

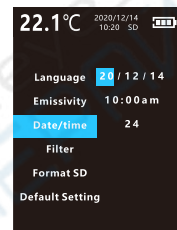

Date and time (Figure 6)

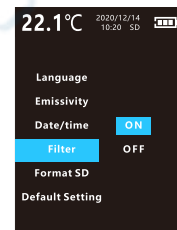

Filter(Figure 7)

(5) Format SD (Figure 8):

Press Up/Down button to select "Format SD", press OK button for modification, press Up/Down button to select ON/OFF, select ON and press enter button, SD card will be formatted and exit.

(6) Default Setting (Figure 9):

Press Up/Down button to select "Default Setting", press enter button for modification, press Up/Down button to select ON/OFF; select ON and press enter button, the instrument will restore factory settings and exit.

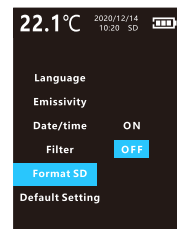

Format SD (Figure 8)

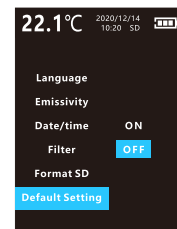

Default Setting (Figure 9)

— 6 —

2. Viewing pictures (Figure 10)

After entering main menu, press Up/Down button and select , press enter button to view pictures, the right side of the icon displays the number of currently viewed picture and the total number of pictures. Press Up/Down button to view pictures, short press Return button to exit.



Viewing pictures (Figure 10)

3. Palette (Figure 11)

After entering main menu, press Up/Down button and select , press enter button for palette menu, press Up/Down button to select color palette, and press enter button again to save and exit. Short press Down button on main interface to switch color palette.

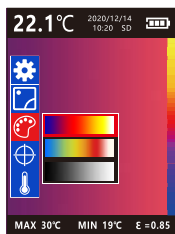

Palette (Figure 11)

4. Center point (Figure 12)

After entering main menu, press the up/down button to select , press enter button for center point menu, press button to select center point icon, and press enter button again to save and exit.

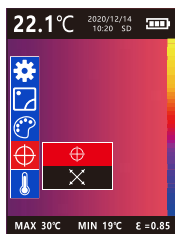

Center point (Figure 12)

— 7 —

5. Temperature unit setting (Figure 13)

After entering main menu, press Up/Down button to select , press enter button to confirm and enter into temperature unit setting menu, and press Up/Down button to select temperature units; press enter button again to save and exit.

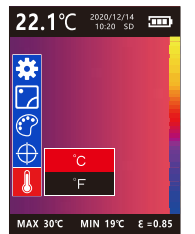

Temperature unit setting (Figure 13)

6. Flashlight:

On main interface, long press enter button to turn on/off the flashlight.

7. Take pictures:

On main interface, short pull trigger once to take a picture, short press enter button to save pictures (pressing Return button does not save pictures)

8. USB charging:

During charging, battery voltage icon is ; when charging is full, it displays .



Specific Declarations:
Our company shall hold no any responsibility resulting from using output from this product as a direct or indirect evidence. We reserves the right to modify product design and specification without further notice.



— 8 —

— 5 —

— 5 —