

# **JDS2800 series**

**Dual-Channel**

**Function/Arbitrary**

**DDS Signal Generator**

**Quick Start Guide**

**Rev1.0**

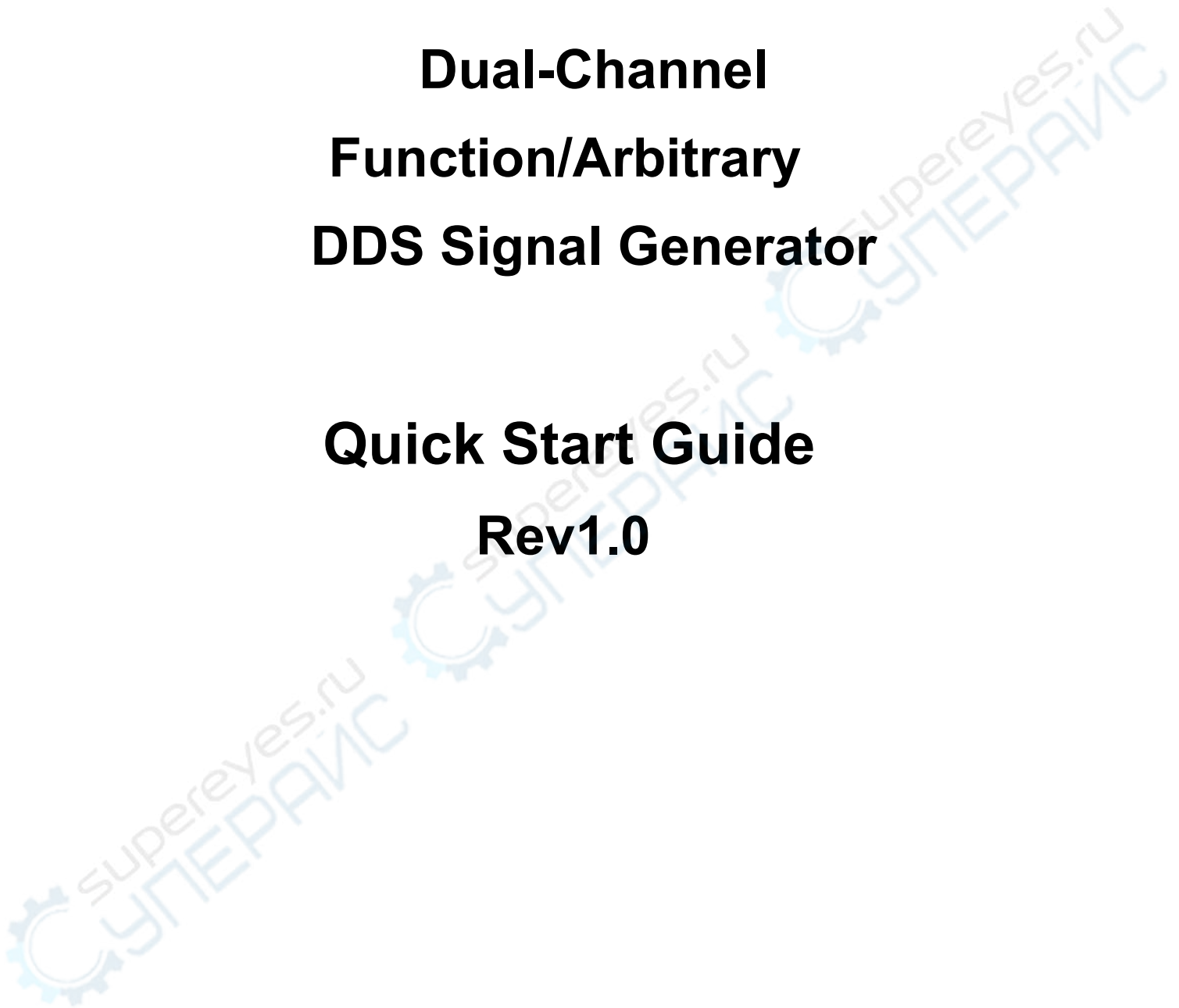

## Contents

<b>Chapter 1 Overview</b>	<b>4</b>
1, Instrument introduction	4
2, Model description	4
3, Dimension	<b>5</b>
4, Technical parameters	5
<b>Chapter II Instrument Description</b>	<b>11</b>
1, Front panel overview	11
2, Display interface description	13
3.The key function description	14
<b>Chapter III Instrument Operation Instructions</b>	<b>15</b>
1, Setting parameters and outputting waveforms in the main interface	15
2, MEAS measurement mode interface parameter settings	16
3, MOD modulation mode interface parameter settings	16
4, System settings interface, parameter settings	18

## Check

When you get a new JDS2800 series dual-channel signal generator, it is recommended that you follow the steps below to check the instrument.

### Check the package

If the package is damaged, keep the damaged packaging or shockproof material until the goods have been fully inspected and the instrument has passed electrical and mechanical tests. If the instrument is damaged due to shipping, please contact the shipper and the carrier for compensation.

### Check accessories

The contents of accessories are as follows. If the contents do not match or the instrument is damaged, contact the dealer or the company.

<b>Host: JDS2800 Series Dual Channel Signal Generator</b>	<b>1pcs</b>
<hr/>	
<b>Accessories: Power Adapter</b>	<b>1pcs</b>
<b>USB cable</b>	<b>1pcs</b>
<b>Signal connection cable</b>	<b>2pcs</b>
<b>User manual</b>	<b>1pcs</b>
<b>CD</b>	<b>1pcs</b>
<hr/>	

### Check the whole machine

If you find that the instrument is damaged, the instrument is not working properly, or fails the performance test, contact your dealer or our company.

TEL: 0371-86106382      QQ1: 1406921960      QQ2: 3155097720

Mail: 1406921960@qq.com,  
3155097720@qq.com

R&D company: Hangzhou Junce Instrument Co., Ltd. WEB:www.junteks.com

# Chapter 1 Overview

## Instrument introduction

JDS2800 series function generator can generate multiple waveforms such as sine wave, square wave, triangle wave, pulse wave, and arbitrary wave. The frequency range up to 60MHz, with duty cycle adjustment, sweep frequency, frequency signal frequency and counter function, and the output signal, amplitude, and frequency can be displayed simultaneously. The series signal generator has excellent amplitude and frequency characteristics, the appearance of this instrument is exquisite and beautiful.

This instrument is widely used in factories, schools, research institutes and laboratories.

## The model description

This series of instruments are divided into three models, the main difference is the maximum frequency of sine wave output, as described below:

Model	Sine wave output maximum frequency
JDS2800-60M	60MHz
JDS2800-40M	40MHz
JDS2800-15M	15MHz

## Dimension

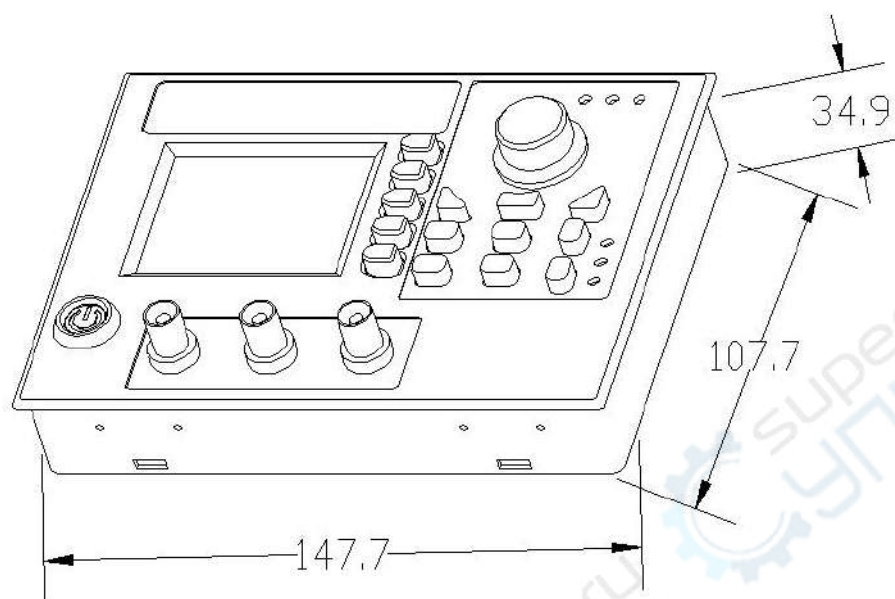

Note: unit mm

## Technical parameters

Frequency characteristics			
	JDS2800 -15M	JDS2800 -40M	JDS2800 -60M
Sine wave frequency range	0~15MHz	0~40MHz	0~60MHz
Square wave frequency range	0~15MHz	0~25MHz	0~25MHz
Triangle wave frequency range			

Pulse wave frequency range			
TTL digital wave frequency range	0~6MHz	0~6MHz	0~6MHz
Arbitrary frequency range			
Pulse width adjustment range	100nS~4000S	40nS~4000S	25nS~4000S
Square wave rise time	≤25ns	≤10ns	≤10ns
Minimum frequency resolution	0.01uHz (0.00000001Hz)		
Frequency accuracy	±20ppm		
Frequency stability	±1ppm/3hours ±1ppm/3 hours		
<b>Waveform characteristics</b>			
Waveform type	Sine、Square、pulse (adjustable duty cycle, precise adjustment of pulse width and period), triangular wave, partial sine wave, CMOS wave, DC level (set DC amplitude by adjusting offset), half wave, full Wave, positive staircase wave, anti-ladder wave, noise wave, exponential rise, exponential drop, multisonic wave, Symplectic pulse and Lorenz pulse and 60 arbitrary waveforms		
Wave length	2048 points		
Waveform sampling rate	266MSa/s		

Waveform vertical resolution	14-bits		
Sine wave	Harmonic Suppression	$\geq 45\text{dBc}(<1\text{MHz});$ $\geq 40\text{dBc}(1\text{MHz}\sim 20\text{MHz})$	
	Total harmonic distortion	$<0.8\%(20\text{Hz}\sim 20\text{kHz}, 0\text{dBm})$	
Square wave and pulse wave	Overshoot	$\leq 5\%$	
Pulse wave	Duty cycle adjustment range	0.1%~99.9%	
Partial sine wave	Duty cycle adjustment range	0.1%~99.9%	
Sawtooth wave	Linearity	$\geq 98\%(0.01\text{Hz}\sim 10\text{kHz})$	
<b>Output characteristics</b>			
Sine wave amplitude range	Frequency $\leq 10\text{MHz}$	10MHz $\leq$ Frequency $\leq$ 30MHz	30MHz $\leq$ Frequency
	2mVpp~20Vpp	2mVpp~10Vpp	2mVpp~5Vpp
Square wave , Triangle wave amplitude range	Frequency $\leq 10\text{MHz}$		10MHz $\leq$ Frequency $\leq 25\text{MHz}$
	2mVpp~20Vpp		2mVpp~5Vpp

Amplitude resolution	1mV		
Amplitude stability	±0.5%/5 hours		
Flatness of amplitude	±5%(<10MHz); ±10%(>10MHz)		
<b>Waveform output</b>			
Output impedance	50Ω±10% (typical)		
Protection	All signal outputs can work within 60 when the load is short-circuited.		
<b>DC offset</b>			
Offset adjustment range	Output amplitude > 2V	0.2V <Output Range ≤ 2V	0 <Output amplitude ≤ 0.2V
	-9.99V~9.99V	-2.5V~2.5V	-0.25V~0.25V
Offset resolution	0.01 V		
<b>Phase characteristics</b>			
Phase adjustment range	0~359.9°		
Phase resolution	0.1°		



<b>TTL/CMOS output</b>		
Low level	<0.3V	
High level	1V~10V	
Level rise/fall time	≤20ns	
<b>External measurement function</b>		
Frequency meter function	Frequency measurement range	1Hz~100MHz
	Measurement accuracy	Gate time 0.01S~10s continuous adjustment
Counter function	Counting range	0-4294967295
	Coupling method	DC and AC coupling methods
	Counting method	Manually
Input signal voltage range	2Vpp~20Vpp	
Pulse width measurement	0.01us resolution, maximum measurable 20s	
Period measurement	0.01us resolution, maximum measurable 20s	

<b>Sweep function</b>		
Sweep channel	CH1 or CH2	
Sweep type	Linear sweep, logarithmic sweep	
Sweep time	0.1s~999.9s	
Setting range	Any setting between the maximum output frequency of the corresponding model of the starting point (0.01Hz) and the end point	
Sweep direction	Forward, reverse and round trip	
<b>Bursting function</b>		
Number of pulses	1-1048575	
Burst mode	Manual burst, CH2 burst, external burst (AC), external burst (DC)	
<b>General specifications</b>		
Display	Display type	2.4 inch TFT color LCD display
Store and load	Quantity	100
	Position	00 to 99 (00 memory location parameter is loaded by default as power on)
Arbitrary wave	Quantity	1 to 60 total 60 groups (15 groups by default as power on)

Interface	Interface mode	USB to serial interface
	Communication speed	Adopt standard 115200bps
	Protocol	Using the command line, the protocol is made public
Power supply	Voltage range	DC5V±0.5V
Manufacturing technology	Surface mount technology, large-scale integrated circuits, high reliability, long service life	
Prompt tone	Users can turn on or off by setting program	
Operating characteristics	All key operations, knob continuous adjustment	
Environmental conditions	Temperature: 0~40 oC Humidity: <80%	

## Chapter II Instrument Description

### 1, The front panel overview

Function softkey: activate corresponding function













## 2, The display interface description



- 1-CH1 parameter
- 2-CH2 parameter
- 3-Waveform Display
- 4- Current Channel Output Status
- 5- Soft-key menu bar
- 6- The phase difference between CH1 and CH2

### 3, The key function description

Item	Instructions
Function soft keys	Function soft-key activates the corresponding function on the screen
	Press  button to display main interface or waveform selection and cancel
	Fast switching between measurement mode interface and main interface
	Fast switching between modulation mode interface and main interface
	Fast switching between system setting interface and main interface
	The main interface is used to control the simultaneous output of channel 1 and channel 2, and in other interface,  key is used to control (ON/OFF).
	When setting parameters, you can use left and right keys to move the cursor position.
	Select the CH1 channel to control the output of CH1, long press to set CH1 as the main display.
	Select the CH2 channel to control the output of CH2, long press to set CH2 as the main display.



# Chapter III Instrument Operation Instructions



After power on, first enter the welcome interface and then jump to the language selection interface. Press the corresponding soft key to select the language and finally enter the main interface. After you turn on the computer again, you do not need to repeat the language selection and go directly to the main interface.



## 1, Set the parameters in the main interface and output waveform



- Press **OK** button to turn the output on or off simultaneously for both channels.
- Output channel selection: The front panel **CH1**, **CH2** keys are used to switch the currently selected channel (CH1 or CH2). Pressing **CH1**, **CH2** keys again in the currently selected channel can turn on/off the output of the channel, and long press to place the current channel on the main display of the screen. (upper part).
- Set the waveform: press the front panel **WAVE** key to activate the waveform switching of the current channel. In the active state of the waveform, the knob can be quickly switched, and the direction key **◀** **▶** can be used to quickly switch between the arbitrary waveform and the preset waveform.
- Set Frequency: Press the soft key **FREQ** to highlight the “Frequency” parameter. At this time, use the direction keys **◀** **▶** to move the cursor to select the bit to be edited. Then turn the knob to change the value. Press and hold the soft key **FREQ** to change the frequency unit (MHz, KHz, Hz, mHz). , uHz).
- Press and hold the duty cycle, offset, and phase soft—keys to initialize to default values.

## 2, MEAS measurement mode interface parameter settings

Press  and press the soft key  in the measurement mode interface to switch between the measurement function and the count function. You can also rotate the encoder to switch.



### 2.1, Measurement function

The input signal frequency, period, positive pulse width, negative pulse width, duty cycle and other parameters can be measured, the measurement frequency range 1Hz-100MHz, the measurement signal amplitude range is 2mVpp-20Vpp, the input interface is Ext.IN;



- Coupling setting: Press  to switch the coupling mode to AC or DC.
- Gate time setting: Press  to set the gate time (0.01S-10S), use the arrow keys to move the cursor to select the bit to be edited, then turn the knob to adjust the value.
- Measurement mode setting: Press  to switch between the two options of counting frequency and counting period via the encoder.
- Measurement parameters: frequency, period, positive pulse width, negative pulse width, duty cycle.

### 2.2, Counting function

The period number of the input signal can be calculated in real time

- Coupling setting: Press  to switch the coupling mode to AC or DC.
- After setting all the items, press the soft key  to start the counting function and press the key  to stop.





## 3, MOD modulation mode interface parameter settings

- Press  to enter the modulation mode, press the soft key  in the modulation mode interface to switch between the sweep function (CH1 channel / CH2 channel), pulse function (CH1 channel) and burst function (CH1 channel).









### 3.1, Sweep function

**Sweep frequency, you can set any starting point frequency and end point frequency in the signal generator output frequency range, sweep time 0.1s~999.9s, sweep type is linear scan, logarithm scan two scan methods, sweep frequency direction is positive , Reverse and Round Trip Three Sweep Directions;**

- In the sweep function (CH1 channel), press the soft key   to select the starting point frequency, end point frequency, sweep time, sweep direction and sweep mode. After the item is highlighted, use the arrow keys (or press the soft key  ) and the knob to edit the item's parameters.
- After setting all the items, press the soft key  to start the sweep function and press the key  to stop.



### 3.2, pulse function

**You can adjust pulse wave pulse width and pulse period time digitally, which is more accurate than adjusting the duty cycle;**

- In the pulse function (CH1 channel), press the soft key   to select the pulse width, period, offset, and amplitude. After this item is highlighted, edit the item parameters by pressing the arrow keys (or press the soft key  ) and rotating the knob. , pulse width and period units can be switched between ns and us by pressing the key  when the item is highlighted.
- After setting all the items, press the soft key  to start the sweep function and press the key  to stop

### 3.3, Bursting function

**The pulse train can be set to output 1-108575 periods. The burst mode is divided into internal CH2 channel bursts, external input signal bursts, and manual bursts. It should be noted that the period time of the burst train is less than the burst signal period time.**

- In the burst function (CH1 channel), press the soft key   to select the number of pulses and the burst mode. After this item is highlighted, use the arrow keys (or press the soft key  ) and the knob to edit the item

parameters.

- After setting all the items, press the soft key **ON** to start the sweep function and press the key **OFF** to stop.

## 4, System settings and interface parameter settings

Press the key **SYS** to enter the system setting interface. Press the soft key

**▲ ▼** to select the parameters for the in/out position, sound setting, brightness adjustment, language setting, synchronization function setting, and arbitrary wave display quantity setting.

- Call Out & Save: Save/recall the current waveform parameters to the specified position, rotate the knob to adjust to the specified position. Press the corresponding soft key when you want to recall, save, or clear.
- Sound settings: Sounds can be turned on and off with keys **ON**、**OFF**.
- Brightness adjustment: Brightness adjustable from 0 to 12 levels can be quickly adjusted by rotating encoder.
- Language setting: Available by pressing **ENG**、**中文** to select English and Chinese display.
- Synchronization: The CH1 channel is used as the operation target during synchronization. The parameters of the CH2 channel change following the CH1 channel parameters. When the synchronization item is highlighted, press the key **◀ ▶** or rotate knob to select the item to be synchronized (frequency, waveform, amplitude, duty cycle, offset), press the soft key **ON** to select it, and press the soft key **OFF** to cancel.
- Arbitrary waveform number setting: The number of arbitrary waveforms of the main interface waveform can be quickly adjusted by rotating the encoder (1-60).