

Waterproof LED Power Supply LPS-C

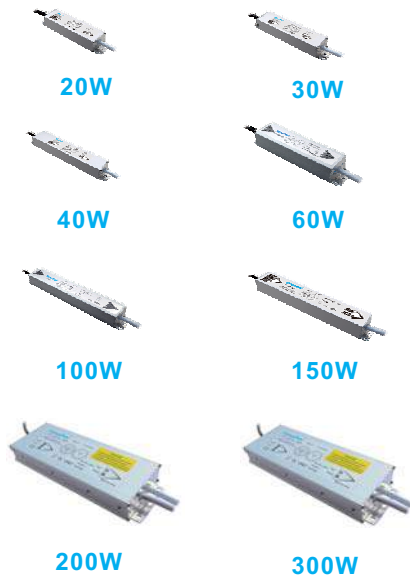

■ Features:

- Constant voltage output
- Protections: Short circuit / Over load
- Cooling by free air convection
- External driver for LED module, strip flex ribbon, spot light, down washer, panel light, ext.....
- CE & LVD tested, suitable for indoor or outdoor LED application with low electro-magnetic disturbance requirement
- Seamless aluminum housing, fully sealed and waterproof
- 100% full load burn-in test

■ Specification:

SELV IP67 CE

MODEL		LPS-24E20C	LPS-24E30C	LPS-24E40C	LPS-24E60C	LPS-24E100C	LPS-24E150C	LPS-24E200C	LPS-24E300C
OUTPUT	DC Output	24V							
	Output Current	0.84A	1.25A	1.67A	2.5A	4.2A	6.25A	8.4A	12.5A
	Voltage Tolerance	±5%							
	Rated Power	20W Max	30W Max	40W Max	60W Max	100W Max	150W Max	200W Max	300W Max
	Ripple Noise	200mV P-P							
	Setup Rise Time	1000mS/220V							
INPUT	Input Voltage	220V±15%							
	Frequency Range	47~63Hz							
	Efficiency	82%	83%	84%	85%	86%	87%	89%	89%
	AC Current @ 220V	0.17A	0.25A	0.33A	0.49A	0.81A	1.21A	1.57A	2.36A
	AC inrush current(max.)	46A@230VAC							
PROTECTION	Over Load	105%-120% rated power , Protection Type:auto-recovery ,after fault condition is removed							
	Short Circuit	Protection Type:recovery automatically after fault condition is removed							
ENVIRONMENT	Operating Temperature	-25°C ~ +40°C							
	Operating Humidity	5% ~ 95%							
	Storage Temperature	-35°C ~ +65°C							
SAFETY & EMC	EMC	EN 55015 : 2006+A2 : 2009 ; EN 61547 : 2009 ; EN 61000-3-2 : 2006+A2 : 2009 ; EN 61000-3-3 : 2008							
	Withstand Voltage	I/P-FG:1.5KV AC I/P-O/P:3.0KV AC							
OTHERS	Dimension(mm)	138x32x25	164x32x25	207x32x25	199x43x34	293x43x34	313x43x34	253x85x36	307x85x36
	Packing Dimension(mm)	315x200x220	315x200x220	410x245x170	440x215x143	440x340x143		455x290x155	455x360x155
	Packing Weight(Kg)	50PCS/10	50PCS/12.5	50PCS/15	20PCS/11	20PCS/16	20PCS/17	10PCS/14	10PCS/17

■ Dimension:

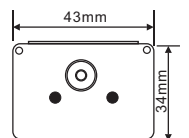
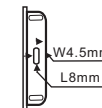
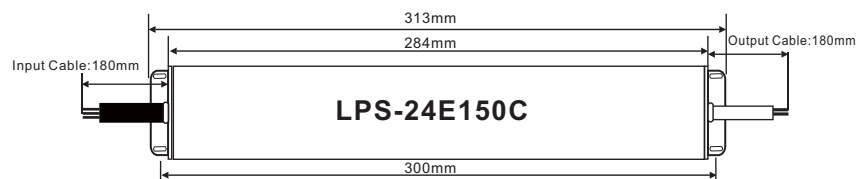
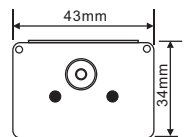
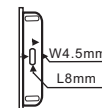
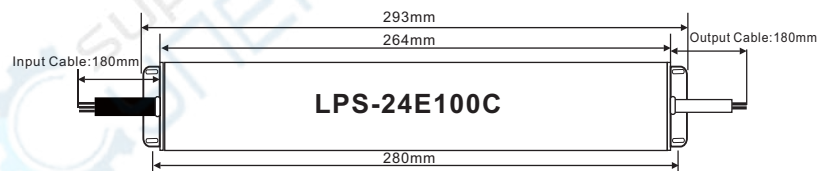
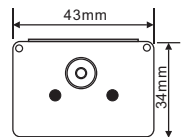
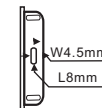
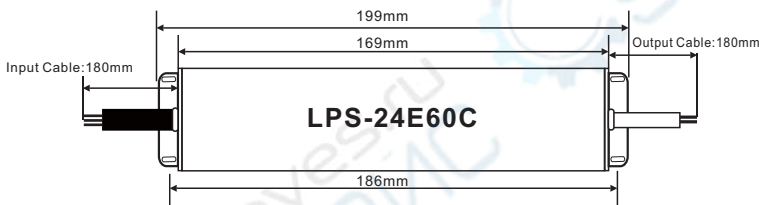
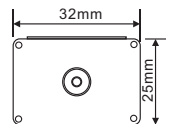
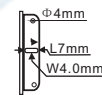
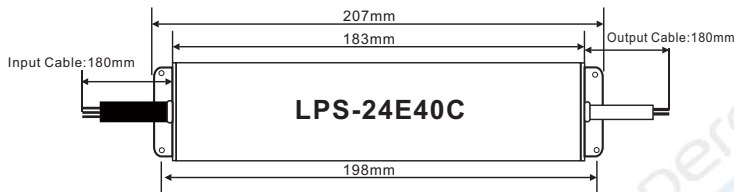
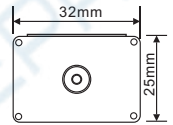
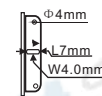
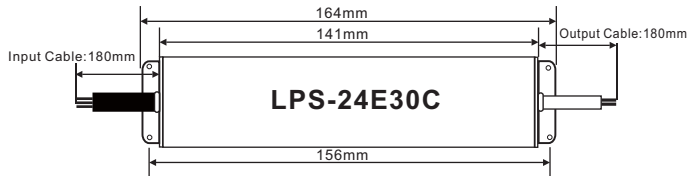
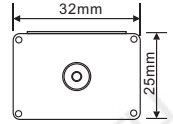
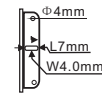
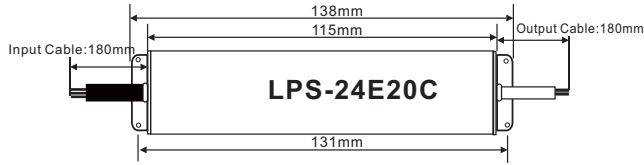

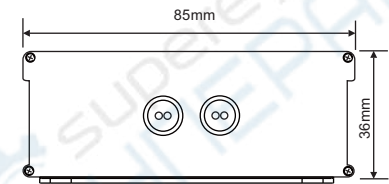
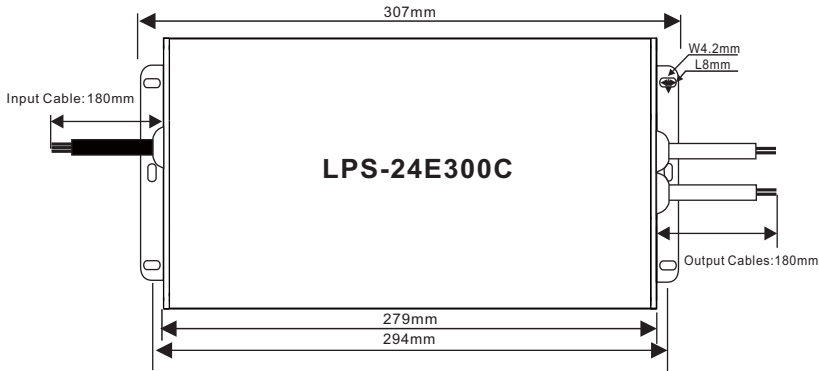
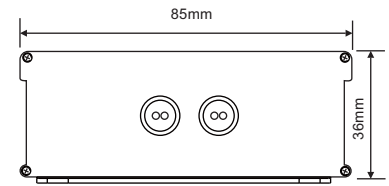
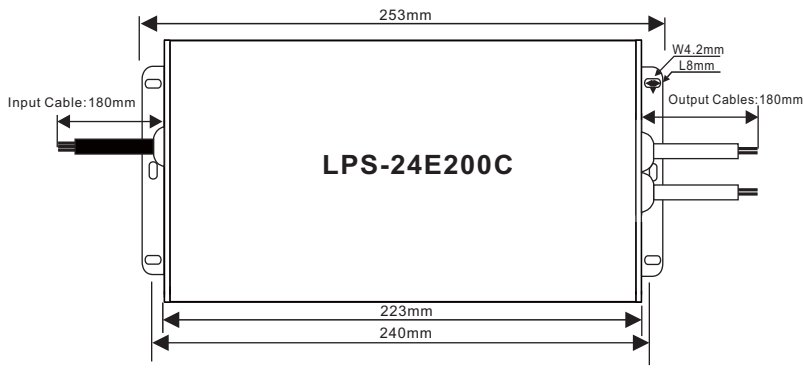

■ Wiring Diagram:

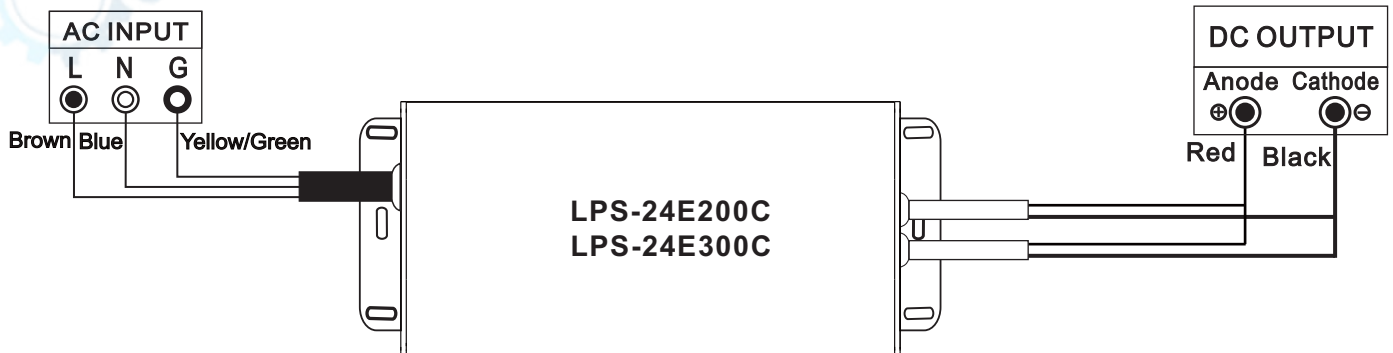
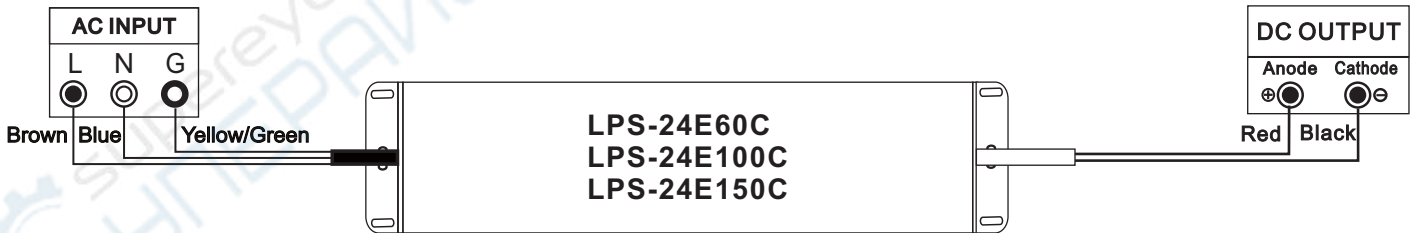
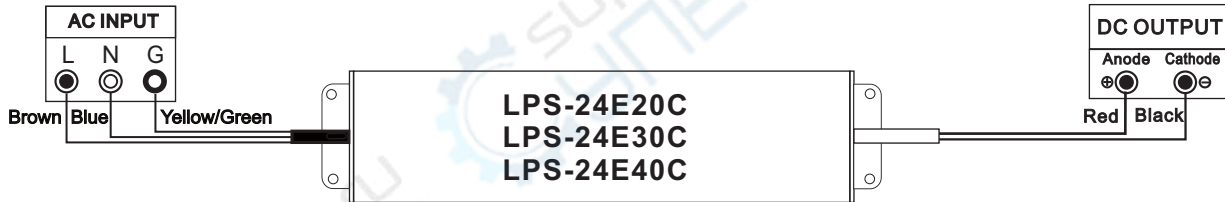

■ Derating Curve:

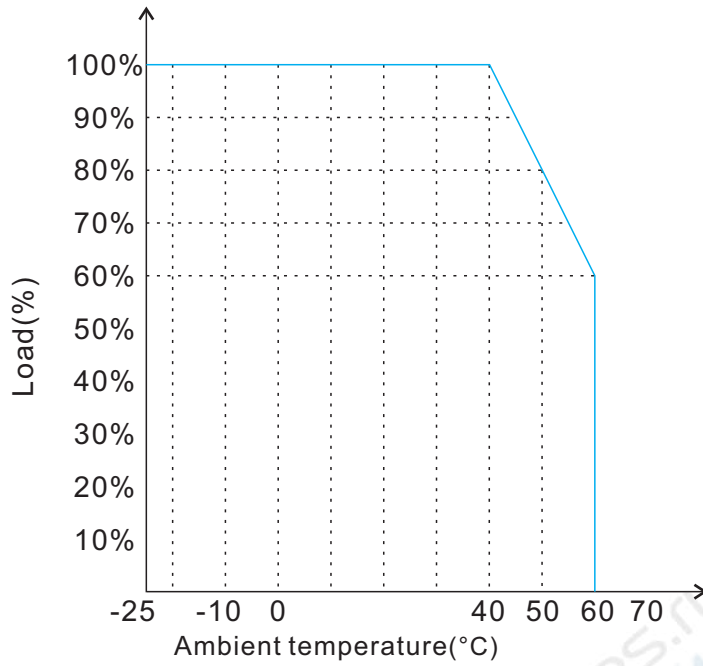

*NOTE: Start-up possible for 220VAC

■ Static Characteristic Curve:

